



DATA SHEET

# ATLAS™ SERIES

## LED LIGHT ENGINES

INTRODUCTION: ATLAS™ SERIES LED LIGHT ENGINES.....	3
CHARACTERISTICS	
FLUX - LUMENS, JUNCTION TEMPERATURE, $T_j=25^{\circ}\text{C}$ .....	4
OPTICAL, WARM WHITE, DAYLIGHT WHITE, AND RGB .....	4
TYPICAL ILLUMINANCE - LUX .....	4
DRIVING LAMINA LIGHT ENGINES.....	5
ELECTRICAL PERFORMANCE, TEMPERATURE, $T_j=25^{\circ}\text{C}$ .....	5
MINIMUM, TYPICAL, AND ABSOLUTE MAXIMUM	
RATINGS - WARM WHITE, DAYLIGHT WHITE, AND RGB.....	6
SPECTRAL DISTRIBUTION	
WARM WHITE, DAYLIGHT WHITE, AND RGB.....	7
MONOCHROMATICS.....	8
TYPICAL RELATIVE FORWARD CURRENT VS. VOLTAGE	
WARM WHITE AND DAYLIGHT WHITE .....	8
RGB .....	9
MONOCHROMATICS.....	10
RELATIVE LUMINOUS FLUX VS. JUNCTION TEMPERATURE	
WARM WHITE, WARM WHITE WITH 60° OPTIC, AND DAYLIGHT WHITE .....	11
DAYLIGHT WHITE WITH 60° OPTIC, AND RGB.....	12
MONOCHROMATICS.....	13
FLUX VS. CURRENT	
WARM WHITE, WARM WHITE WITH 60° OPTIC, AND DAYLIGHT WHITE .....	14
DAYLIGHT WHITE WITH 60° OPTIC AND OPTIC RGB. ....	15
MONOCHROMATICS.....	16
EFFICACY VS. CURRENT	
WARM WHITE, DAYLIGHT WHITE, AND RGB.....	17
MONOCHROMATICS.....	18
BIN STRUCTURE	
WARM WHITE AND DAYLIGHT WHITE .....	19
PROJECTED LUMEN MAINTENANCE	
WARM WHITE, DAYLIGHT WHITE, RGB AND MONOCHROMATICS .....	20
RELATIVE LUMINOUS INTENSITY	
WARM WHITE, DAYLIGHT WHITE, RGB, AND MONOCHROMATICS .....	21
RELATIVE LUMINOUS INTENSITY (POLAR)	
WARM WHITE, DAYLIGHT WHITE.....	21
RGB .....	22
MECHANICAL DIMENSIONS	
WARM WHITE, DAYLIGHT WHITE, RGB, AND MONOCHROMATICS .....	23
SOLDER PAD DESIGN .....	23
ELECTRICAL CONNECTIONS	
WHITES .....	23
RGB .....	24
EZ-CONNECT LIGHT SOURCE.....	24
PACKAGING TAPE & REEL, CARRIER TAPE, AND PACKAGING TRAYS.....	25
PATENTS, CONNECTIONS, ASSEMBLY, AND PACKAGING .....	26
RoHS AND WARRANTY STATEMENT.....	27

TABLE OF CONTENTS

# ATLAS™ SERIES LED LIGHT ENGINES

Lamina LED light engines are manufactured by combining high brightness LEDs from industry-leading LED manufacturers with our own proprietary thermal packaging technology. This technology is a performance breakthrough for LED packaging, a key factor in determining LED life and reliability. This unmatched thermal performance allows Lamina to densely cluster multiple LEDs to achieve exceptionally high luminous intensity in very small footprints.

The Lamina Atlas Series is available in Warm White (3050K), Daylight White (4700K) and RGB. The Atlas Warm White delivers 160+ lumens from a single point. An enhanced red and orange color spectrum and a CRI of 80 make this product ideal for incandescent and halogen replacements. The Atlas RGB, through three independently controlled input/output channels (red, green and blue), produces any of 16 million beautifully saturated and blended colors (including white with variable color temperature) from a single point source.

Atlas LED light engines are configured with a single cavity populated with multiple LEDs to deliver the maximum usable light. The Atlas makes possible applications which, until now, could only be accomplished with traditional lighting sources.

## Features:

- Round footprint for design flexibility
- Designed for popular drive currents from 700mA to 1050mA
- Lamina narrow, medium and wide beam optics are available
- Isolated metal base makes wiring in series or parallel possible on a common heat sink
- Integrated ESD protection - 4,000V HBM
- Superior thermal performance for unmatched reliability
- Long life and high lumen maintenance
- Available mounted to Lamina EZ-Connect™ boards for solderless connections
- Lamina Heat Sinks and Developer Kits available for rapid prototyping

The unsurpassed technical benefits found in the Atlas Series result in unparalleled ease of design and integration. They feature the lowest thermal resistance of any LED package on the market. Our patented multi-layer on metal package design allows the most efficient

path to dissipate the heat generated by the LED. This low thermal resistance gives you the choice to use a smaller heat sink or to run your parts at a higher power rating while still maintaining a safe junction temperature.

Lamina provides unmatched product integration support. Our experienced Application Engineers, knowledgeable in LED design integration, optics, thermal management, and electronics are just a phone call away. To request a sample or to speak with an Application Engineer, call us at 800-808-5822 or +1 609-265-1401.

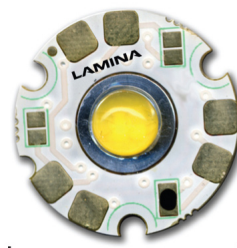

0.80 [20.32] Diameter

INTRODUCTION

## APPLICATIONS



# CHARACTERISTICS

## Flux Characteristics - Lumens Junction Temperature, T<sub>j</sub>=25°C

Part Number	Color	Drive Current (mA)	TYP / MIN (lm)	Drive Current (mA)	TYP / MIN (lm)
NT-42D1-0425	Warm White	700	156 / 124	1050	206 / 164
NT2-42D1-0529 (Atlas II)	Warm White	700	244 / 195	1050	305 / 243
NT-42D0-0426	Daylight White	700	244 / 195	1050	309 / 247
NT-43F0-0424	RGB - Red	350	69 / 47	525	100 / 63
	RGB - Green	350	109 / 87	525	142 / 113
	RGB - Blue	350	29 / 23	525	40 / 32
NT-41E0-0483	Amber	700	131 / 104	-	-
NT-42B1-0484	Blue	700	63 / 50	-	-
NT-42C1-0485	Green	700	216 / 172	-	-
NT-41A0-0482	Red	700	109 / 69	-	-

Table 1.

## Optical Characteristics, Whites

Part Number	Color	Color Temp. Min. (K)	Color Temp. Max. (K)	Total Incl. Angle	<sup>1)</sup> View Angle	CRI Min.	CRI Typ.
NT-42D1-0425	Warm White	2750	3550	180°	108°	70	80
NT-42D0-0426	Daylight White	3950	6200	180°	110°	60	66

Table 2.

Note: 1. 2θ, 1/2, Total off-axis angle from source center line where the intensity is 1/2 of the peak value.

## Optical Characteristics, RGB & Monochromatics

Part Number	Color	Dominant Wave Length Min. (nm)	Dominant Wave Length Max. (nm)	Total Incl. Angle	<sup>1)</sup> View Angle
NT-43F0-0424	RGB - Red	619	629	180°	116
	RGB - Green	515	535	180°	113
	RGB - Blue	460	470	180°	132
NT-41E0-0483	Amber	584	594	180°	103
NT-42B1-0484	Blue	460	470	180°	108
NT-42C1-0485	Green	515	535	180°	107
NT-41A0-0482	Red	619	629	180°	105

Table 3.

Note: 1. 2θ, 1/2, Total off-axis angle from source center line where the intensity is 1/2 of the peak value.

## Typical Illuminance Characteristics

Part Number	Color	Drive Current (mA)	cbcp	Illuminance (Lux)				Illuminance (fc)			
				Distance from Source [M]				Distance from Source [FT]			
				1	2	5	10	3.3	6.6	16.4	32.8
NT-42D1-0425	Warm White	700	57	57.3	14.3	2.3	0.6	5.3	1.3	0.2	0.1
		1050	76	75.7	18.9	3.0	0.8	7.0	1.8	0.3	0.1
NT2-42D1-0529	Warm White (Atlas II)	700	92	91.9	23.0	3.7	0.9	8.5	2.1	0.3	0.1
		1050	140	139.7	34.9	5.6	1.4	13.0	3.2	0.5	0.1
NT-42D0-0426	Daylight White	700	85	84.7	21.2	3.4	0.8	7.9	2.0	0.3	0.1
		1050	107	107.2	26.8	4.3	1.1	10.0	2.5	0.4	0.1
NT-43F0-0424	RGB - Red	350	22	21.8	5.5	0.9	0.2	2.0	0.5	0.1	0.0
		525	32	31.7	7.9	1.3	0.3	2.9	0.7	0.1	0.0
	RGB - Green	350	37	37.5	9.4	1.5	0.4	3.5	0.9	0.1	0.0
		525	49	48.8	12.2	2.0	0.5	4.5	1.1	0.2	0.0
	RGB - Blue	350	8	8.1	2.0	0.3	0.1	0.8	0.2	0.0	0.0
		525	11	11.1	2.8	0.4	0.1	1.0	0.3	0.0	0.0
NT-41E0-0483	Amber	700	57	56.9	14.2	2.3	0.6	5.3	1.3	0.2	0.1
NT-42B1-0484	Blue	700	23	23.4	5.9	0.9	0.2	2.2	0.5	0.1	0.0
NT-42C1-0485	Green	700	78	77.9	19.5	3.1	0.8	7.2	1.8	0.3	0.1
NT-41A0-0482	Red	700	43	43.3	10.8	1.7	0.4	4.0	1.0	0.2	0.0

Table 4.

### Typical Illuminance Characteristics - Continued

60° Built-In Optic				Illuminance (Lux) Distance from Source [M]				Illuminance (fc) Distance from Source [FT]			
Part Number	Color	Drive Current (mA)	cbcp	1	2	5	10	3.3	6.6	16.4	32.8
				99.0	24.7	4.0	1.0	9.2	2.3	0.4	0.1
NT-45D0-0447	Daylight White	700	99	99.0	24.7	4.0	1.0	9.2	2.3	0.4	0.1
		1050	136	136.4	34.1	5.5	1.4	12.7	3.2	0.5	0.1
NT-45D1-0446	Warm White	700	72	71.8	18.0	2.9	0.7	6.7	1.7	0.3	0.1
		1050	98	97.8	24.4	3.9	1.0	9.1	2.3	0.4	0.1

Table 5.

### Driving Lamina Light Engines

Lamina Atlas Series light engines are designed to operate under current controlled conditions, either constant current, PWM or other current control methods. The Atlas Series is designed to operate using commercially available driver sources from many electronic power supply companies. Lamina's Application Engineering team can assist with the proper selection of drivers and can assist with your own drive current design.

Connecting power to high brightness LEDs in the past has been challenging. Lamina has developed EZ-Connect boards and wire harnesses to make assembly fast and reliable.

### Electrical Performance Characteristics Junction Temperature, $T_j = 25^\circ\text{C}$

Part Number	Color	Forward Voltage (VDC)		Typical Power (W)	Typical Temperature Coefficient of Forward Voltage (mV/°C)	Current (mA)	Typical Thermal Resistance Junction to Case (°C/W)
		Typ.	Max.				
NT-42D1-0425	Warm White	7.5	8.2	5.3	-6.12	700	3.0
NT-42D0-0426	Daylight White	7.6	8.2	5.3	-9.29	700	3.0
NT-43F0-0424	RGB -Red	4.8	6.4	1.7	-3.55	350	6.0
	RGB - Green	7.4	8.4	2.6	-5.2	350	6.0
	RGB - Blue	7.9	9.0	2.8	-7.87	350	6.0
NT-43F0-0424 RGB Combined Typical						350	2.0
NT-41E0-0483	Amber	4.9	6.5	3.4	-7	700	3.0
NT-42B1-0484	Blue	6.9	7.9	4.8	-9	700	3.0
NT-42C1-0485	Green	7.4	8.4	5.2	-9	700	3.0
NT-41A0-0482	Red	4.7	6.3	3.3	-7	700	3.0

Table 6.

# CHARACTERISTICS - CONT.

## Minimum, Typical, and Absolute Maximum Ratings, Warm White NT-42D1-0425 and Daylight White NT-42D0-0426

	Symbol	Min.	Typ.	Max.	Unit
Thermal Resistance <sup>[1]</sup>	$T_R$	-	3.0	3.5	°C/W
Insulation Resistance <sup>[2]</sup>	-	1.0	-	-	MΩ
Electrical Isolation <sup>[3]</sup>	-	100	-	-	V
Reverse Current	-	-	-	50	mA
Reverse Voltage	-	-	-	+5	V
LED Junction Temperature <sup>[4]</sup>	$T_J$	-	-	+125	°C
Storage Temperature	-	-40	-	+100	°C
Assembly Temperature	-	-	-	+210	°C
ESD Sensitivity	HBM	-	-	4000	V
Current	mA	-	-	1400	mA DC

## Minimum, Typical, and Absolute Maximum Ratings, RGB NT-43F0-0424

	Symbol	Min.	Typ.	Max.	Unit
Thermal Resistance <sup>[1]</sup>	$T_R$	-	2.0	2.3	°C/W
Thermal Resistance <sup>[5]</sup> RGB	$T_R$	-	6.0	7.0	°C/W
Insulation Resistance <sup>[2]</sup>	-	1.0	-	-	MΩ
Electrical Isolation <sup>[3]</sup>	-	100	-	-	V
Reverse Current	-	-	-	50	mA
Reverse Voltage	-	-	-	5	V
LED Junction Temperature <sup>[4]</sup>	$T_J$	-	-	+125	°C
Storage Temperature	-	-40	-	+100	°C
Assembly Temperature	-	-	-	+210	°C
ESD Sensitivity	HBM	-	-	4000	V
Current Per Color	mA	-	-	700	mA DC

Table 6.

Notes:

1. Thermal resistance including thermal grease (Wakefield P/N 120), as measured from LED junction to heat sink.
2. Insulation resistance between any terminal and base.
3. Electrical isolation voltage between any terminal and base.
4. Lower junction temperatures improve lumen maintenance.

Table 7.

Notes:

1. Total thermal resistance all colors on, including thermal grease (Wakefield P/N 120), as measured from LED junction to heat sink.
2. Insulation resistance between any terminal and base.
3. Electrical isolation voltage between any terminal and base.
4. Lower junction temperatures improve lumen maintenance.
5. Thermal resistance including thermal grease (Wakefield P/N 120), as measured from LED junction to heat sink.



# SPECTRAL DISTRIBUTION

Warm White (NT-42D1-0425)  
@ 700mA, 25° C Heat Sink

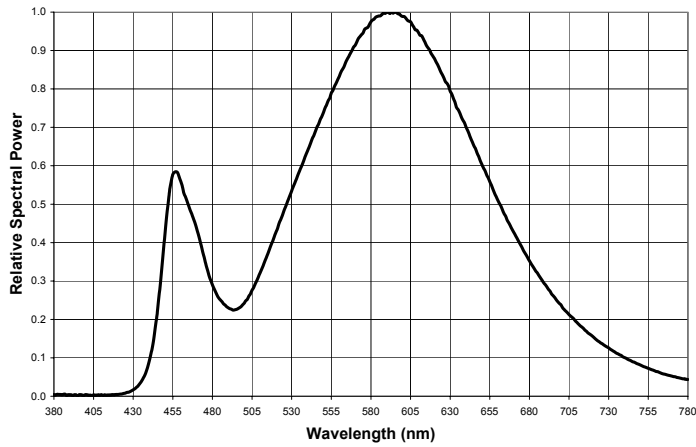

Figure 1a.

Daylight White (NT-42D0-0426)  
@ 700mA, 25° C Heat Sink

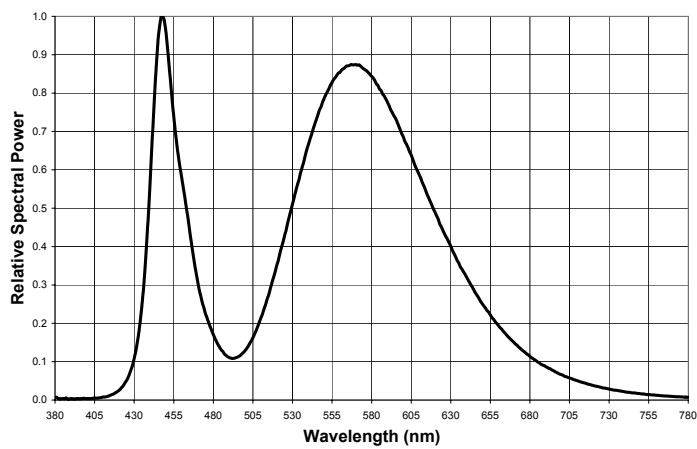

Figure 1b.

RGB (NT-43F0-0424)  
@ 350mA, 25° C Heat Sink

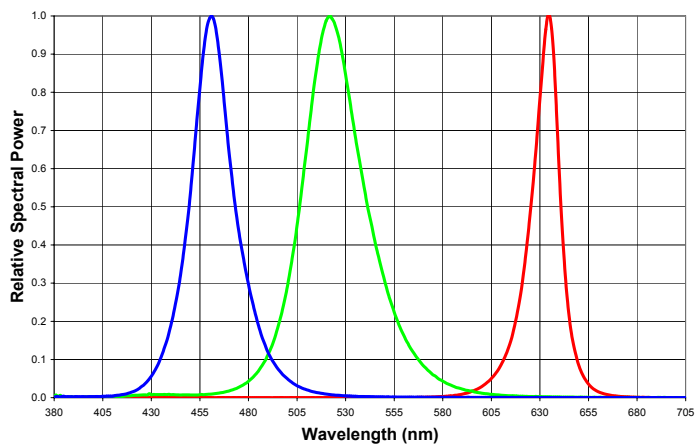
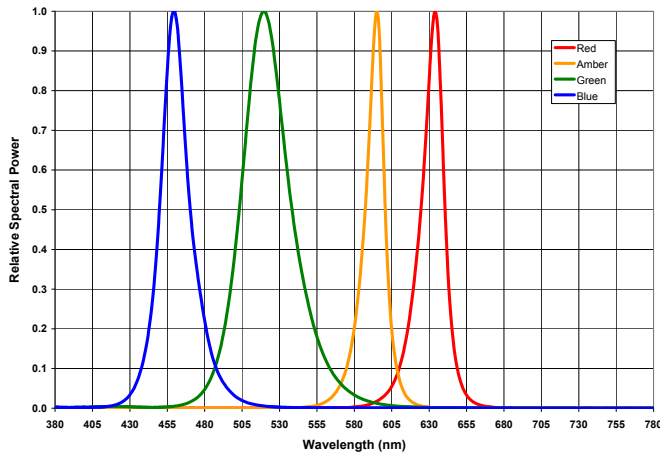

Figure 1c.

# SPECTRAL DISTRIBUTION MONOCHROMATICS @700MA, 25°C HEAT SINK

Blue (NT-42B1-0484), Green (NT-42C1-0485),  
Amber (NT-41E0-0483), and Red (NT-41A0-0482)

Figure 1d.



## TYPICAL RELATIVE FORWARD CURRENT VS. FORWARD VOLTAGE

Warm White (NT-42D1-0425)

Figure 2a.

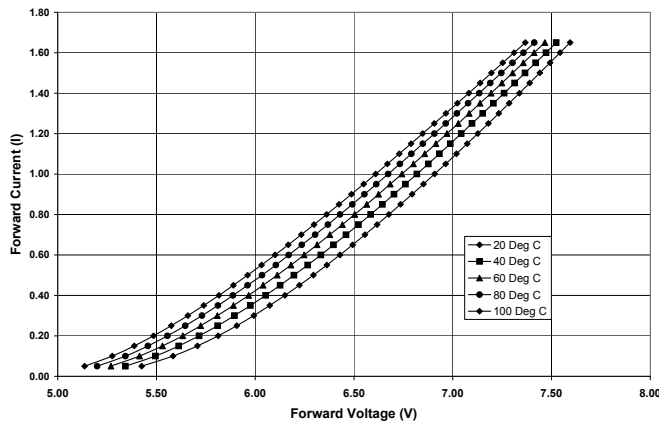

Daylight White (NT-42D0-0426)

Figure 2b.

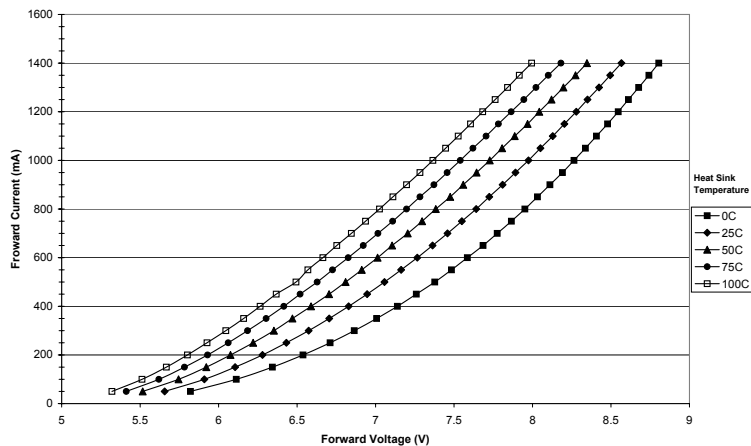



# TYPICAL RELATIVE FORWARD CURRENT VS. FORWARD VOLTAGE RGB

Red (NT-41A0-0482)

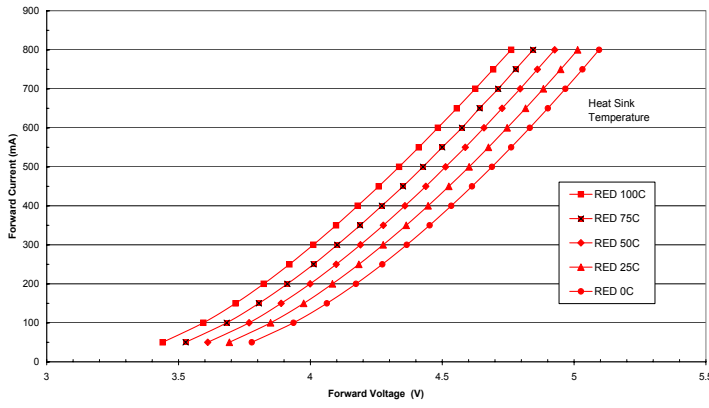

Figure 2c.

Green (NT-42C1-0485)

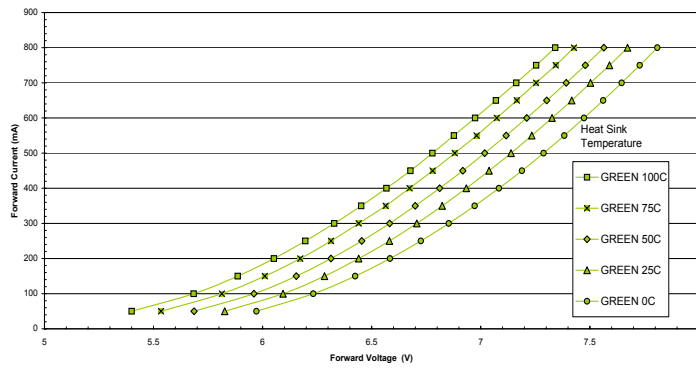

Figure 2d.

Blue (NT-42B1-0484)

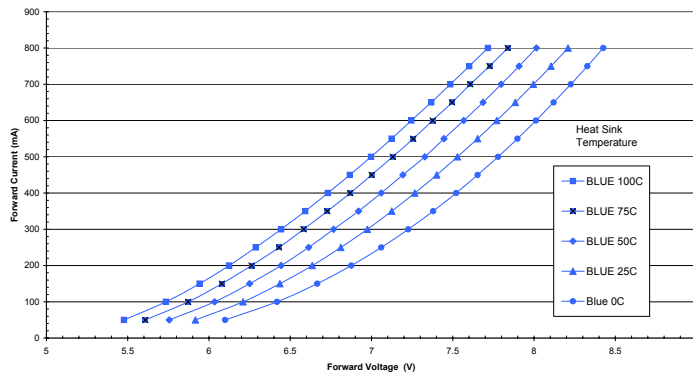

Figure 2e.

# TYPICAL RELATIVE FORWARD CURRENT VS. FORWARD VOLTAGE MONOCHROMATICS

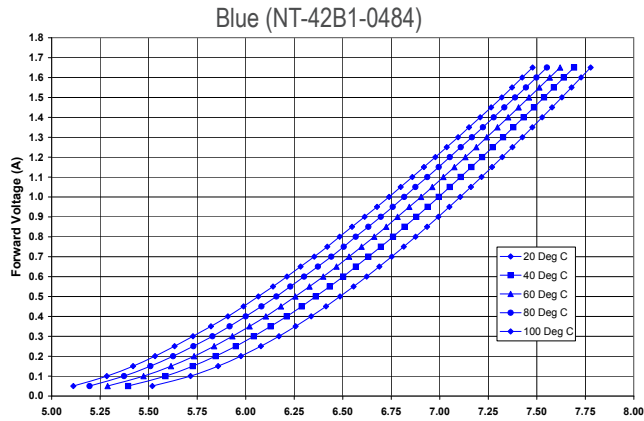

Figure 2f.

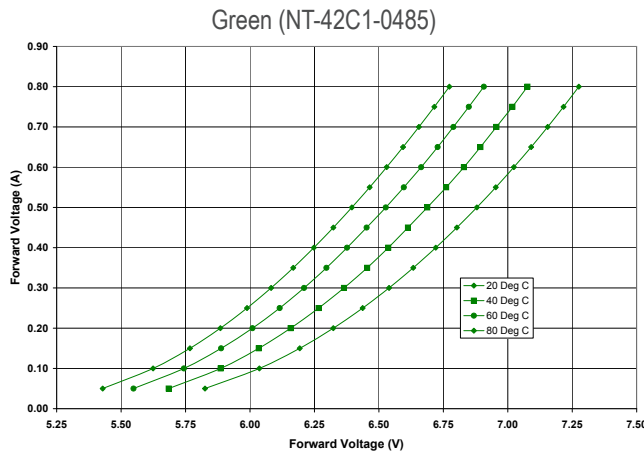

Figure 2g.

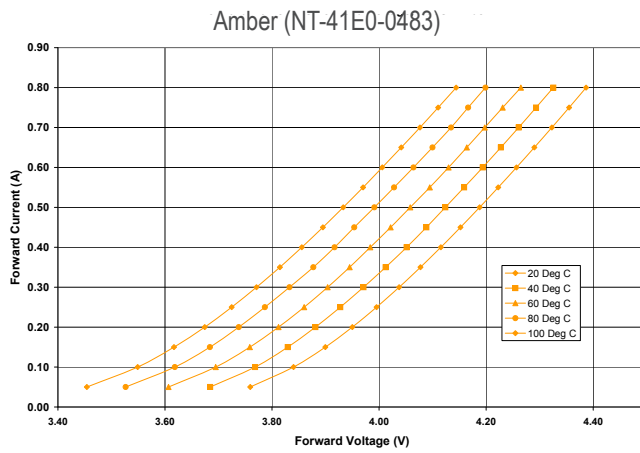

Figure 2h.

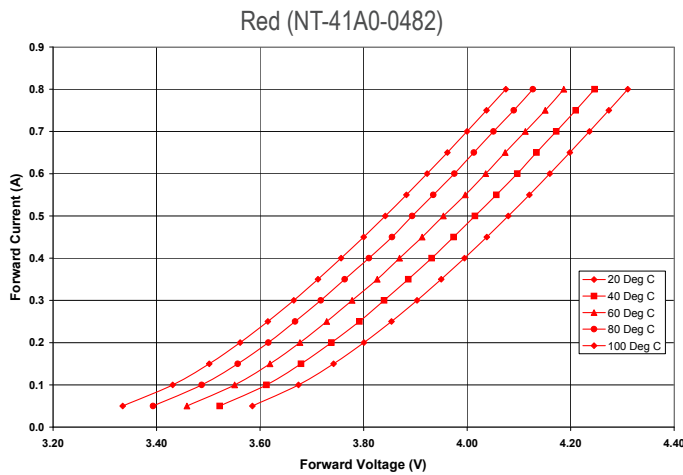

Figure 2i.

# RELATIVE LUMINOUS FLUX VS. JUNCTION TEMPERATURE

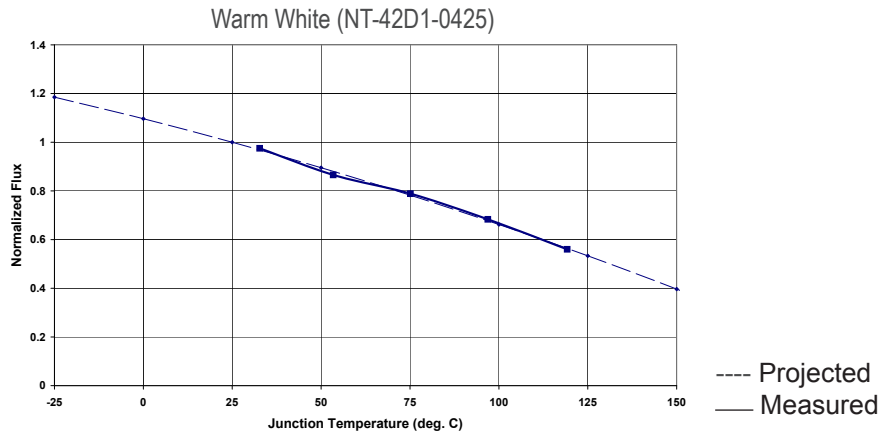

Figure 3a.

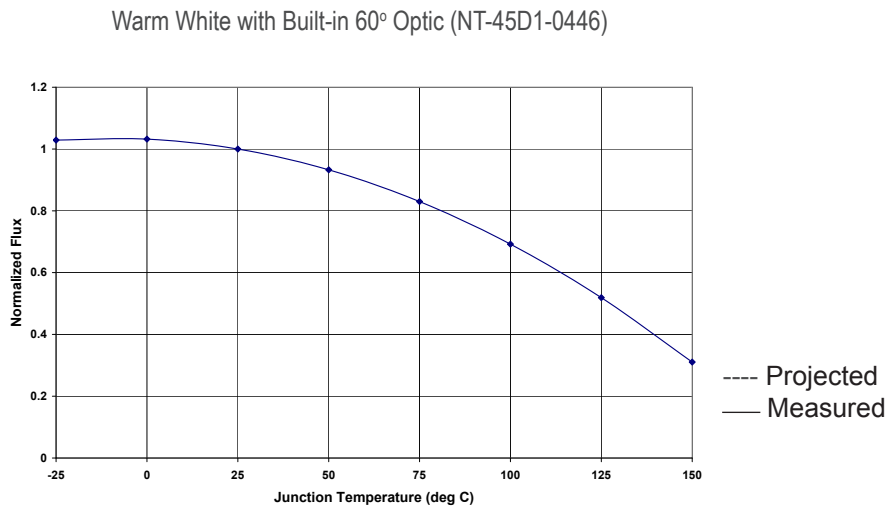

Figure 3b.

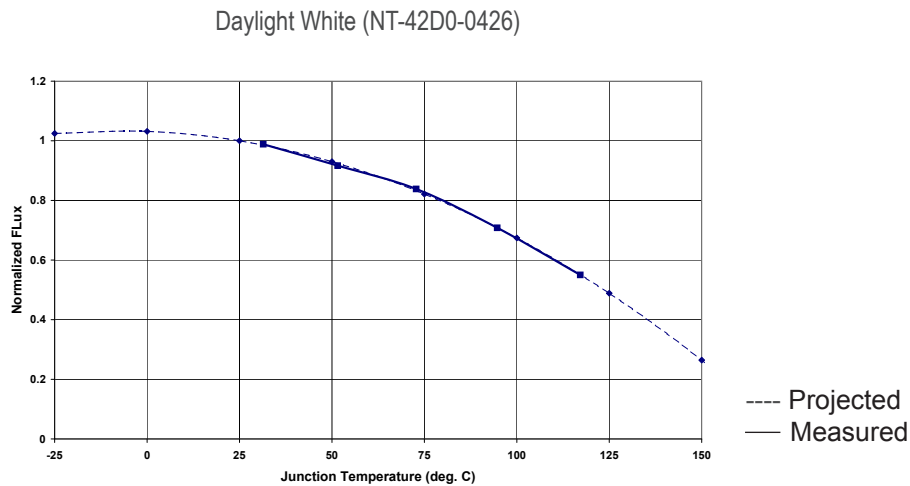

Figure 3c.

# RELATIVE LUMINOUS FLUX VS. JUNCTION TEMPERATURE

Daylight White with Built-in 60° Optic (NT-45D0-0447)

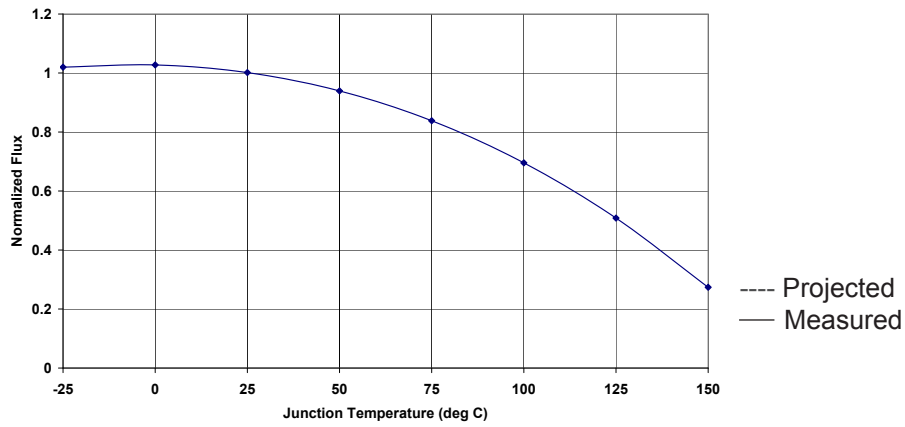

Figure 3d.

RGB (NT-43F0-0424)

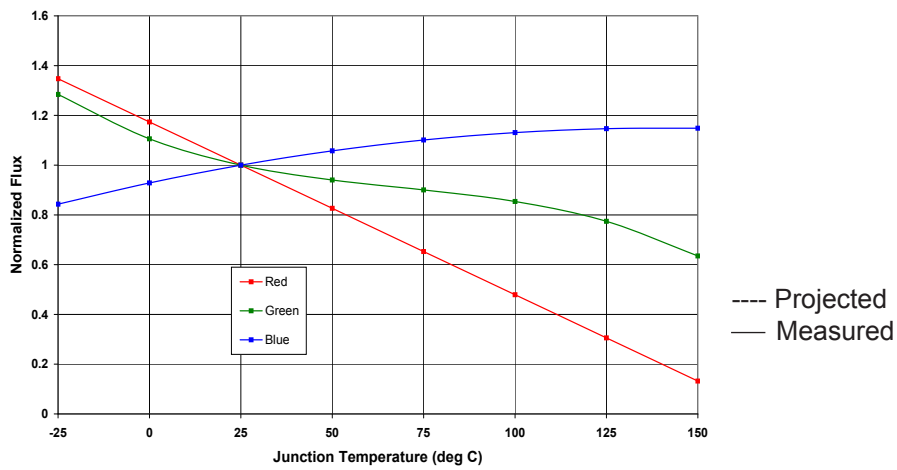

Figure 3e.

# RELATIVE LUMINOUS FLUX VS. JUNCTION TEMPERATURE MONOCHROMATICS

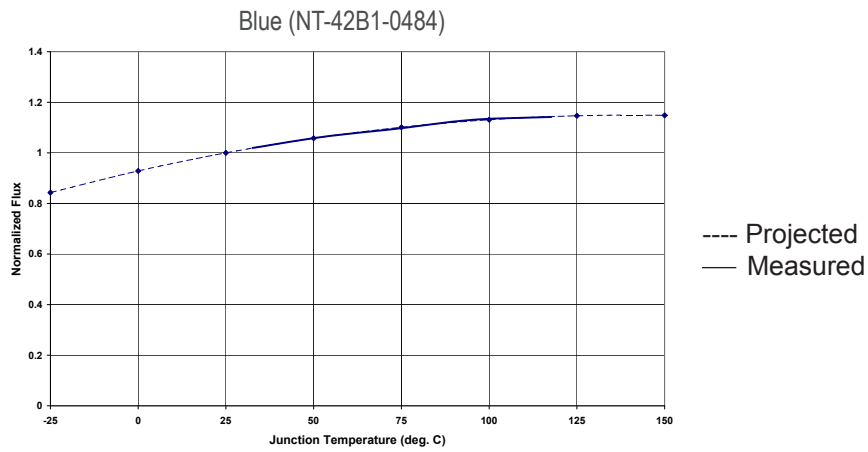

Figure 3f.

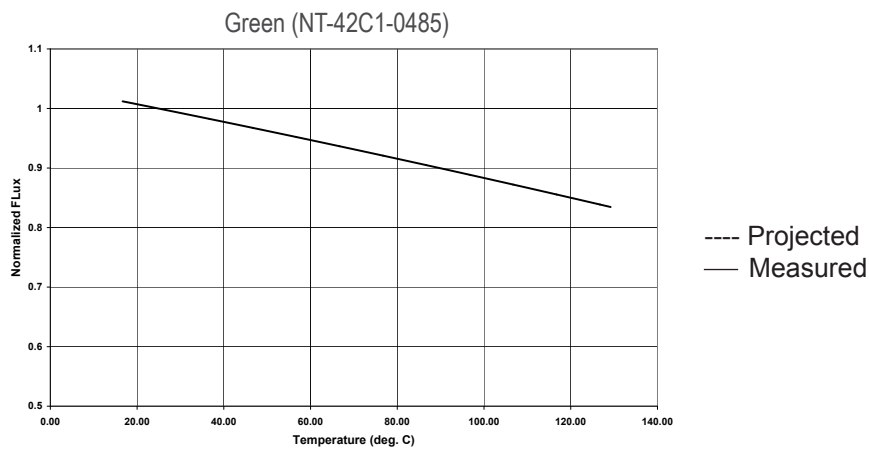

Figure 3g.

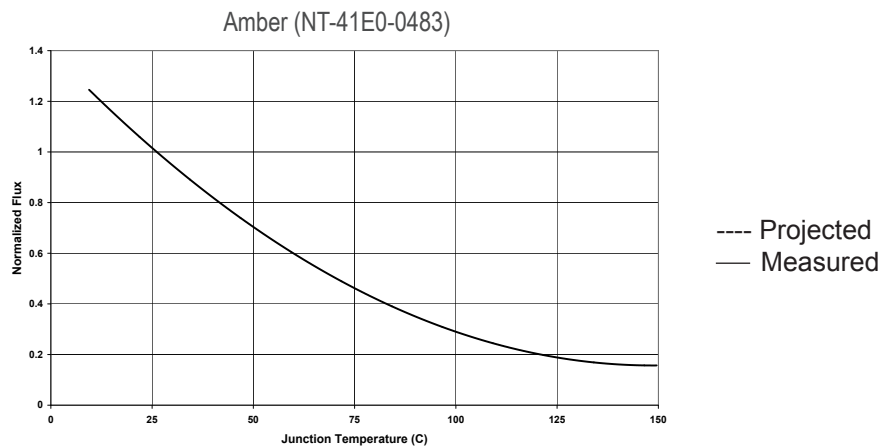

Figure 3h.

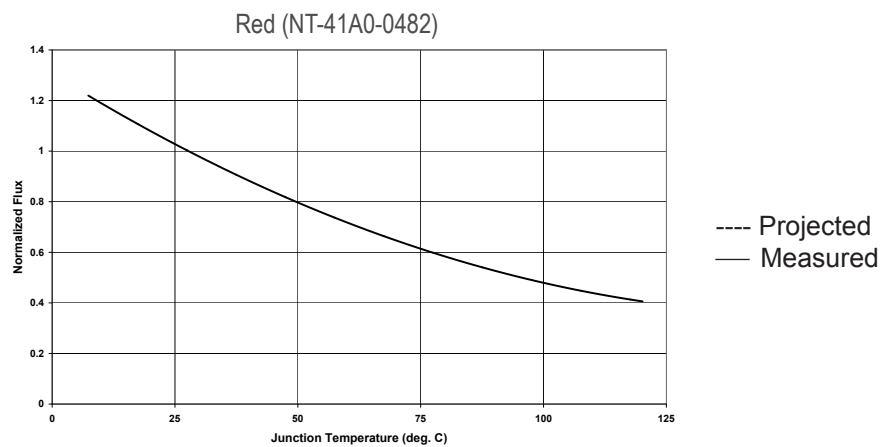

Figure 3i.

# FLUX VS. CURRENT

## Warm White (NT-42D1-0425)

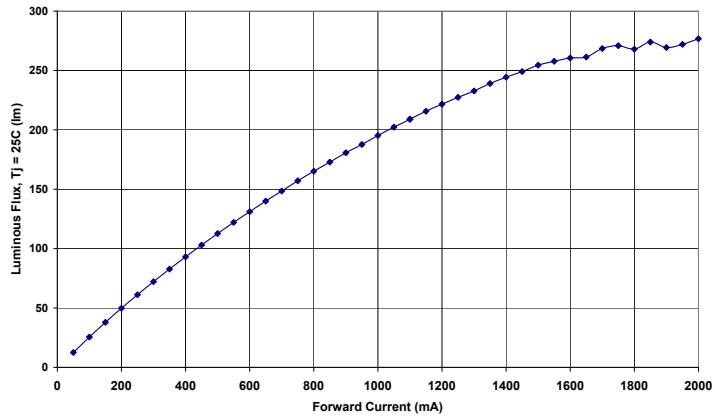

Figure 4a.

## Warm White with Built-in 60° Optic (NT-45D1-0446)

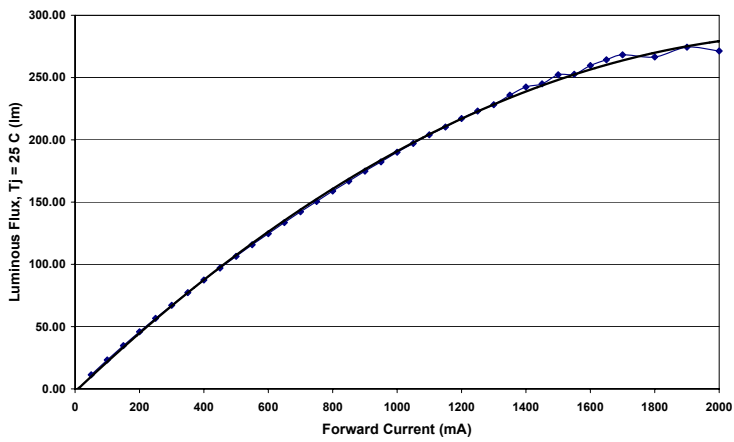

Figure 4b.

## Daylight White (NT-42D0-0426)

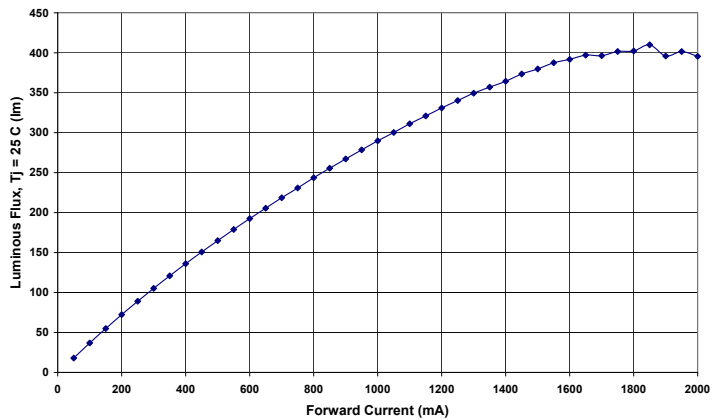

Figure 4c.

# FLUX VS. CURRENT

Daylight White with Built in 60° Optic (NT-45D0-0447)

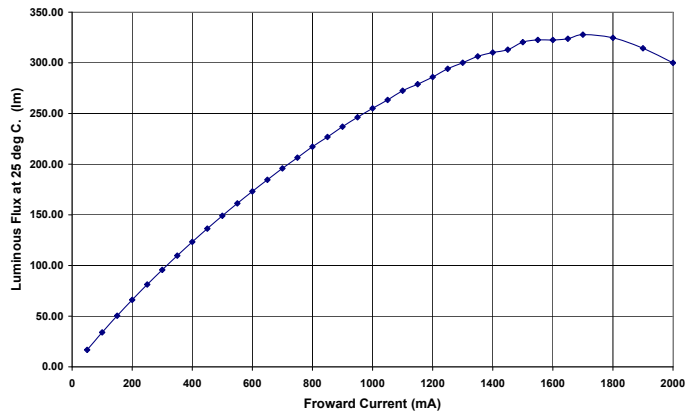

Figure 4d.

RGB (NT-43F0-0424)

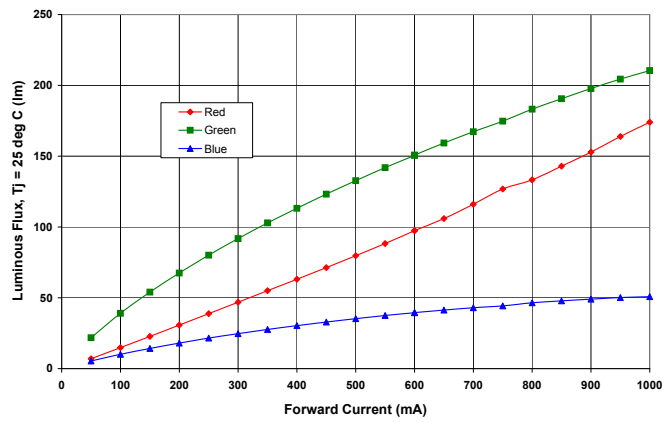

Figure 4e.

# FLUX VS. CURRENT MONOCHROMATICS

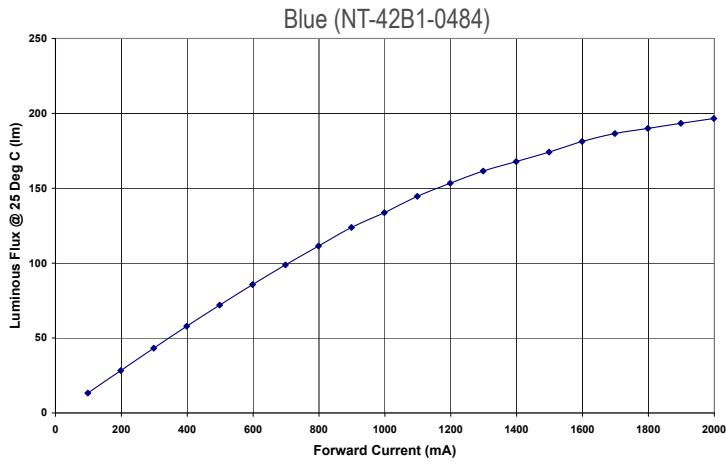

Figure 4f.

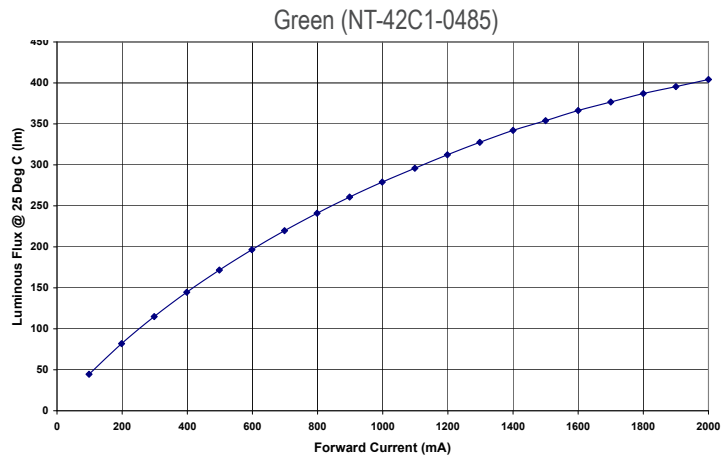

Figure 4g.

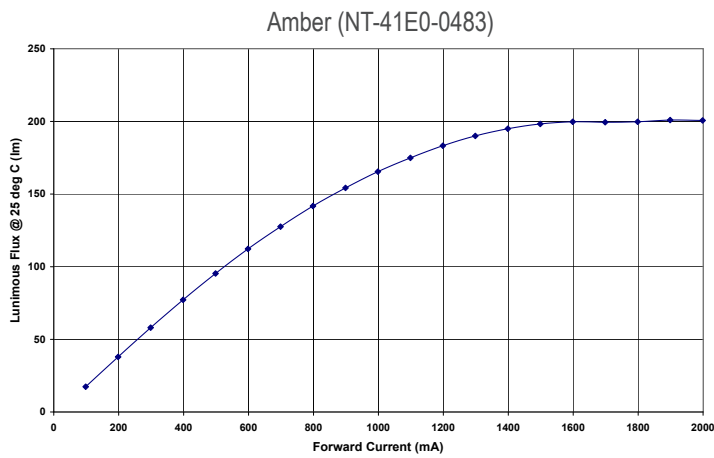

Figure 4h.

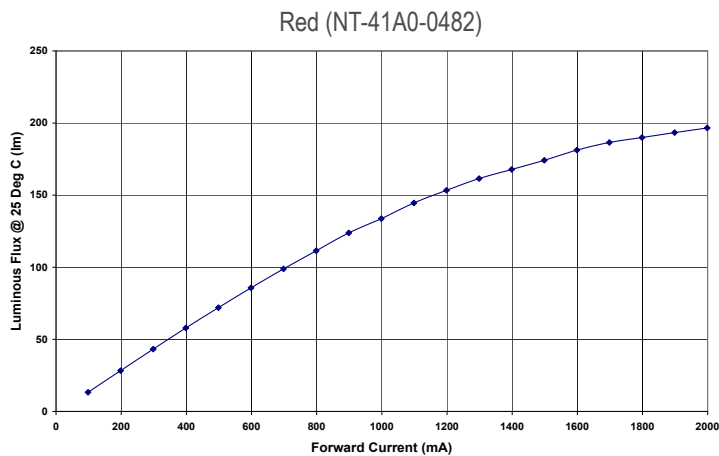

Figure 4i.





# EFFICACY VS. CURRENT

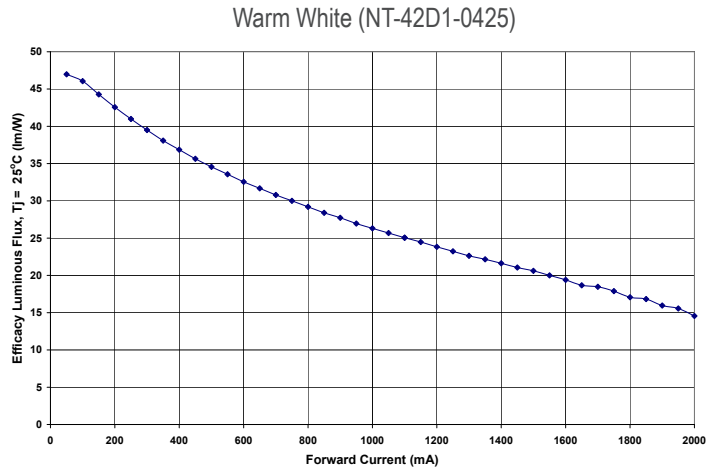

Figure 5a.

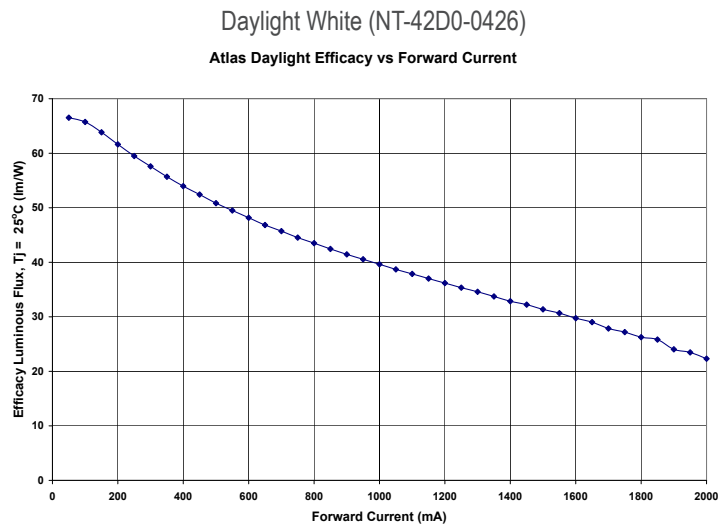

Figure 5b.

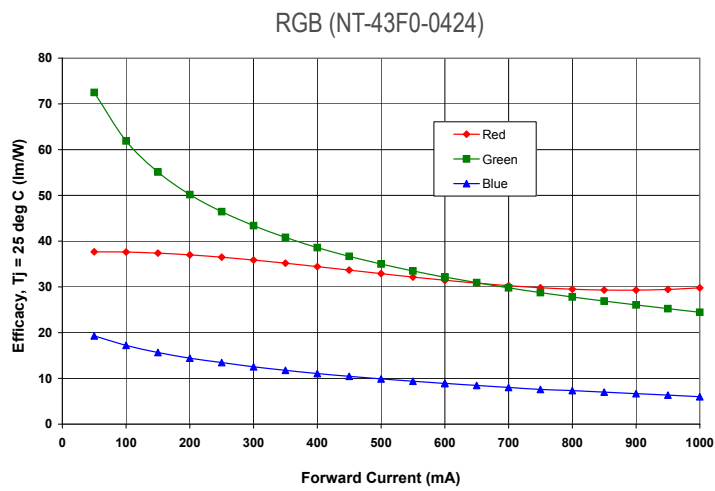

Figure 5c.

# EFFICACY VS. CURRENT MONOCHROMATICS

Blue (NT-42B1-0484)

Figure 5d.

Available 2nd Quarter 2008

Green (NT-42C1-0485)

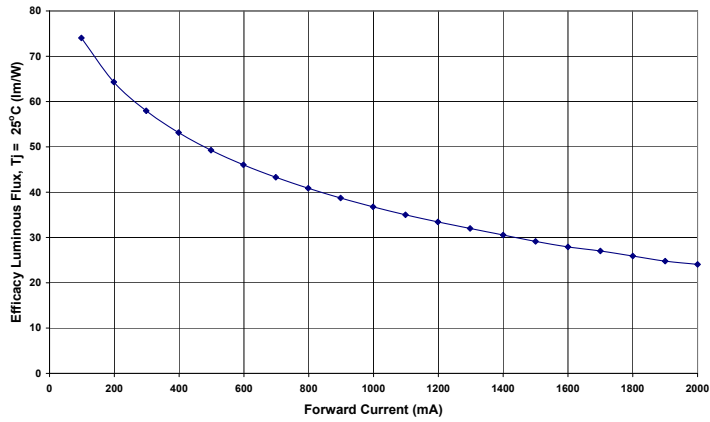

Figure 5e.

Amber (NT-41E0-0483)

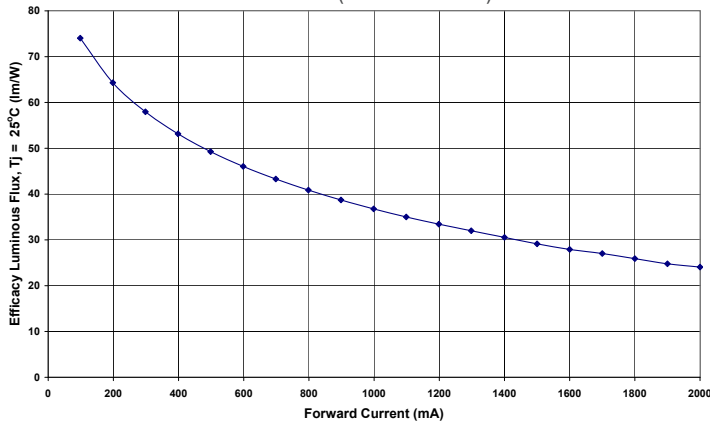

Figure 5f.

Red (NT-41A0-0482)

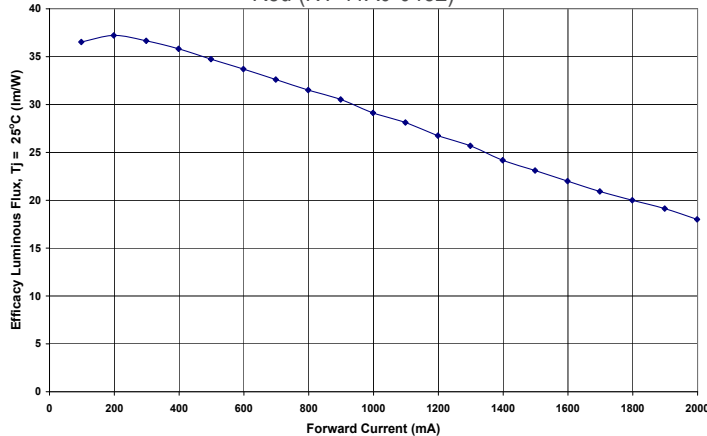

Figure 5g.



# BIN STRUCTURE

## Warm White (NT-42D1-0425)

Figure 6a. CIE Reference 1931, 2°

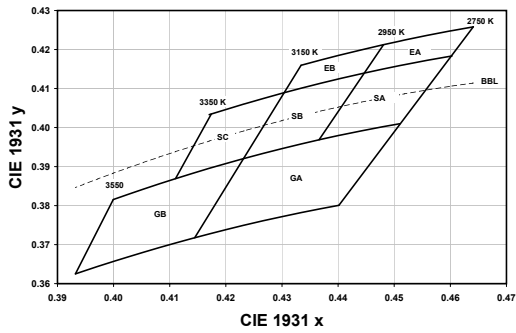

Bin Code	X	Y	Typical CCT (°K)
EB	0.4481	0.4212	3050
	0.4448	0.4140	
	0.4305	0.4089	
	0.4334	0.4159	
EA	0.4641	0.4258	2850
	0.4603	0.4183	
	0.4448	0.4140	
	0.4481	0.4212	
SC	0.4305	0.4089	3250
	0.4232	0.3920	
	0.4110	0.3869	
	0.4174	0.4034	
SB	0.4448	0.4140	3050
	0.4366	0.3968	
	0.4232	0.3920	
	0.4305	0.4089	
SA	0.4603	0.4183	2850
	0.4510	0.4009	
	0.4366	0.3968	
	0.4448	0.4140	
GB	0.4232	0.3920	3350
	0.4144	0.3717	
	0.3932	0.3625	
	0.3999	0.3815	
GA	0.4510	0.4009	2950
	0.4401	0.3800	
	0.4144	0.3717	
	0.4232	0.3920	

Table 8a. Note: Typical relative Warm White Bin NT-42D1-0425.

## Daylight White (NT-42D0-0426)

Figure 6b. CIE Reference 1931, 2°

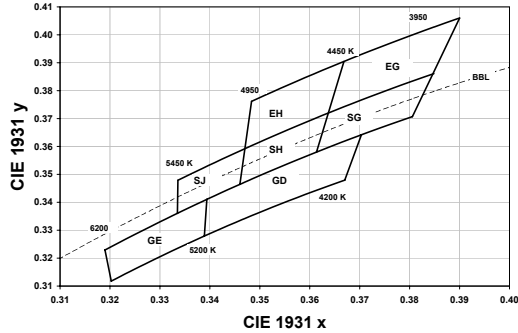

Bin Code	X	Y	Typical CCT (°K)
EH	0.3668	0.3904	4700
	0.3637	0.3719	
	0.3469	0.3591	
	0.3483	0.3761	
EG	0.3900	0.4060	4200
	0.3848	0.3861	
	0.3637	0.3719	
	0.3668	0.3904	
SJ	0.3469	0.3591	5200
	0.3460	0.3464	
	0.3335	0.3360	
	0.3336	0.3479	
SH	0.3637	0.3719	4700
	0.3613	0.3580	
	0.3460	0.3464	
	0.3469	0.3591	
SG	0.3848	0.3861	4200
	0.3805	0.3706	
	0.3613	0.3580	
	0.3637	0.3719	
GE	0.3394	0.3410	5700
	0.3389	0.3279	
	0.3202	0.3117	
	0.3190	0.3229	
GD	0.3703	0.3641	4700
	0.3670	0.3479	
	0.3389	0.3279	
	0.3394	0.3410	

Figure 8b. Note: Typical relative Daylight White Bin NT-42D0-0426.

# PROJECTED LUMEN MAINTENANCE

Lifetime for solid-state devices (LEDs) is typically defined in terms of lumen maintenance - the percentage of initial light output remaining after a specified period of time.

The Warm White (NT-42D1-0425) and Daylight White (NT-42D0-0426) will deliver 70% lumen maintenance at 50,000 hours of operation at a forward current of 700mA. This projection is based on constant current operation with junction temperature maintained at or below 120°C. The RGB (NT-43F0-0424) will deliver, 70% lumen maintenance at 50,000 hours of operation at a forward current of 350mA. This projection is based on constant current operation with junction temperature maintained at or below 120°C.

This performance is based on independent test data. Lamina's historical data from tests run on similar material systems, and internal reliability testing. Observation of design limits included in this data sheet is required in order to achieve this project lumen maintenance.

Warm White (NT-42D1-0425), Daylight White (NT-42D0-0426), and RGB (NT-43F0-0424)

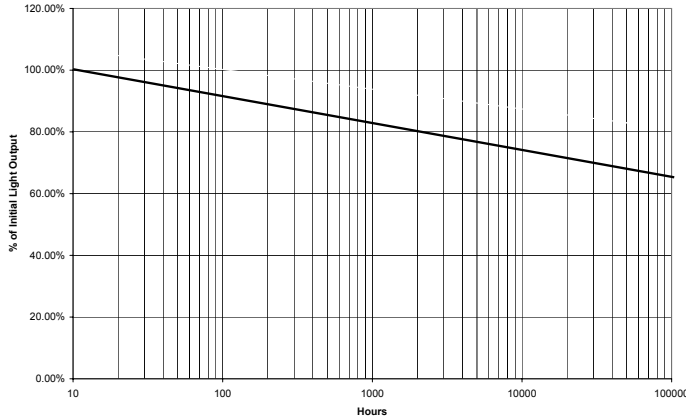

Figure 7a.

Blue (NT-42B1-0484), Green (NT-42C1-0485),  
Amber (NT-41E0-0483), and Red (NT-41A0-0482)

Figure 7b.

Available 2nd Quarter 2008

# RELATIVE LUMINOUS INTENSITY

Warm White (NT-42D1-0425), Daylight White (NT-42D0-0426)  
and RGB (NT-43F0-0424)

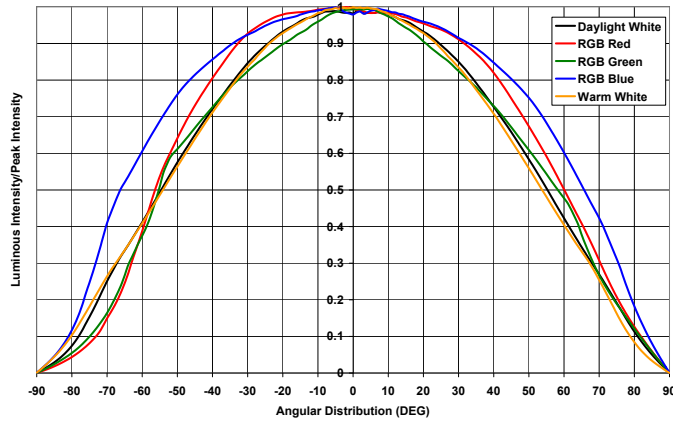

Figure 8a.

Blue (NT-42B1-0484), Green (NT-42C1-0485),  
Amber (NT-41E0-0483), and Red (NT-41A0-0482)

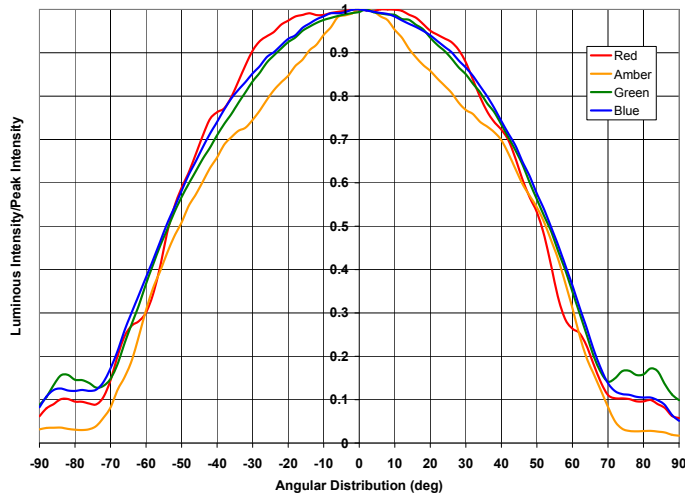

Figure 8b.

# RELATIVE LUMINOUS INTENSITY (POLAR)

Warm White (NT-42D1-0425) and  
Daylight White (NT-42D0-0426) (Polar)

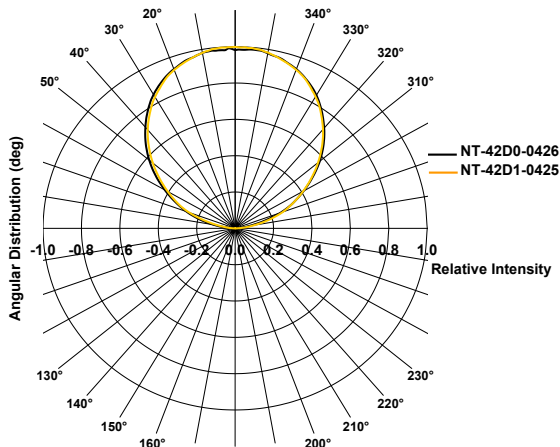

Figure 9a.

Typical Beam Pattern - Lamina's Atlas™ LED light engines project a 108° - 132° (2θ, 1/2, 50% of peak value) Lambertian radiation pattern. Narrower beam distributions can be produced by use of selected popular LED optics. Please contact Lamina Application Engineering for support with your optical needs.

# RELATIVE LUMINOUS INTENSITY (POLAR)

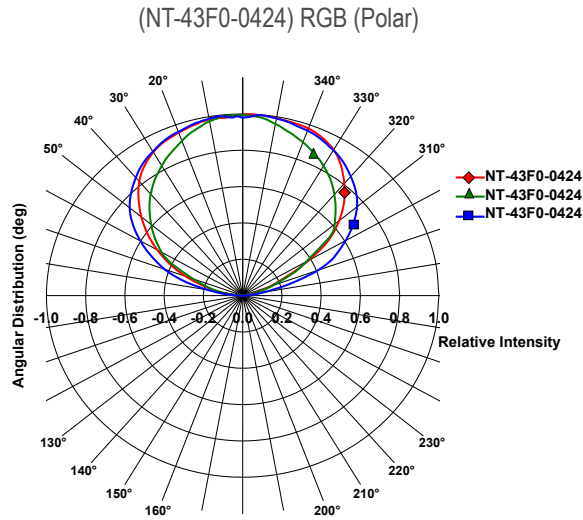

Figure 9b.

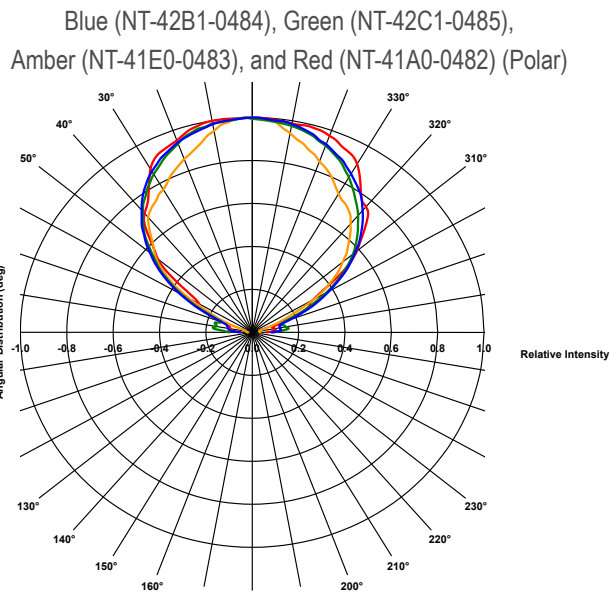

Figure 9c.

## MECHANICAL DIMENSIONS

Warm White (NT-42D1-0425), Daylight White (NT-42D0-0426)

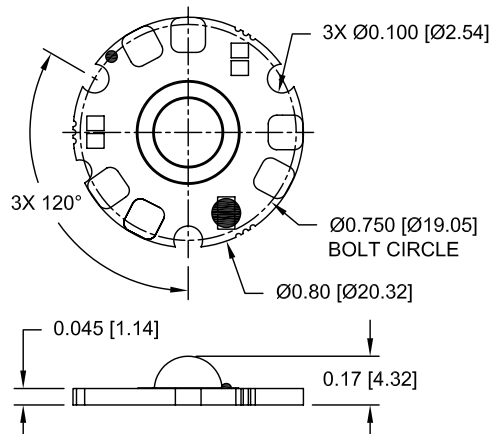

Figure 10.  
 All dimensions are for reference only. Do not handle device by the lens. Care must be taken to avoid damage to the lens. Drawing not to scale.

Units: Inches [millimeters]

# MECHANICAL DIMENSIONS

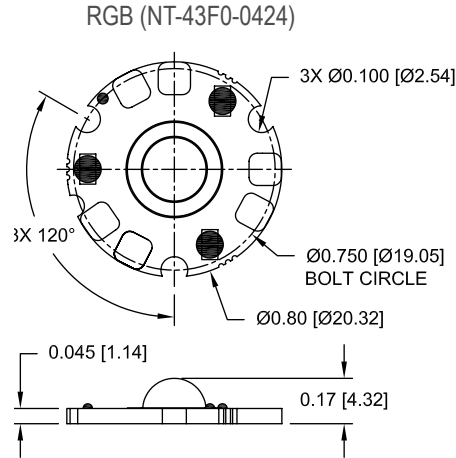

Figure 10b.  
All dimensions are for reference only. Do not handle device by the lens. Care must be taken to avoid damage to the lens. Drawing not to scale.

Units: Inches [millimeters]

# SOLDER PAD DESIGN

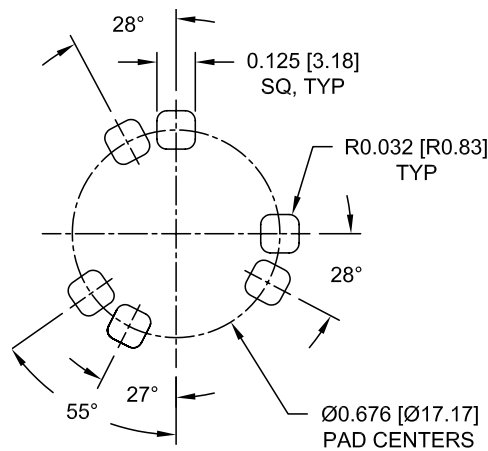

Figure 11.  
For optimal thermal performance thermal grease or epoxy should be added beneath the entire surface of the LED array. All dimensions are for reference only.

Units: Inches [millimeters]

### Thermal Design

Proper thermal design is essential to achieving maximum life and performance. There are many ways you can reduce the junction temperature of your product and increase its useful life. Heat sinks, both active and passive, come in many styles and sizes. Choosing the correct heat sink for your design will maximize the performance and add to the unique aesthetic quality of your product. Thermal tape is not recommended for attachment to heat sinks.

# ELECTRICAL CONNECTIONS

Warm White (NT-42D1-0425) and Daylight White (NT-42D0-0426)

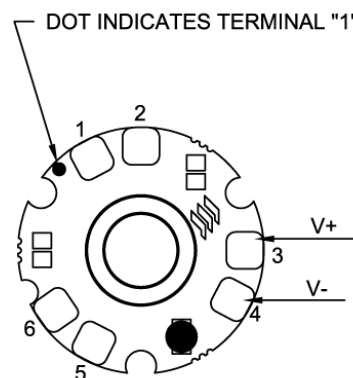

Figure 12a.  
Do not handle device by the lens. Care must be taken to avoid damage to the lens. Drawing not to scale.

Units: Inches [millimeters]

# ELECTRICAL CONNECTIONS

RGB (NT-43F0-0424)

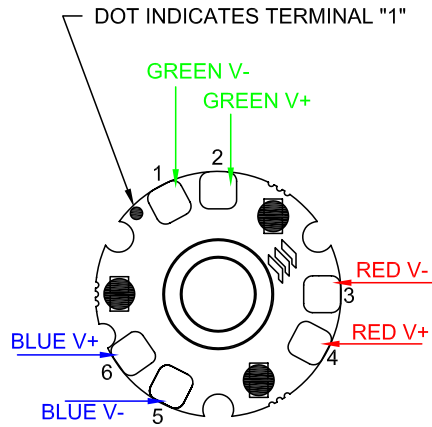

Figure 12b.  
Do not handle device by the lens.  
Care must be taken to avoid damage to the lens. Drawing not to scale.

Units: Inches [millimeters]

# EZ-CONNECT LIGHT SOURCE

RGB (EZ-43F0-0431), Warm White (EZ-42D1-0432),  
Daylight White (EZ-42D0-0433)

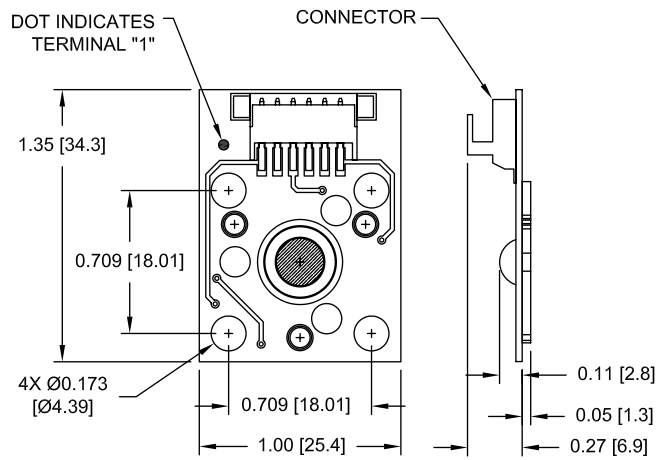

Figure 13.

Units: Inches [millimeters]

Light engine mounted on EZConnect board dimensions are for reference only.



# PACKAGING TAPE & REEL

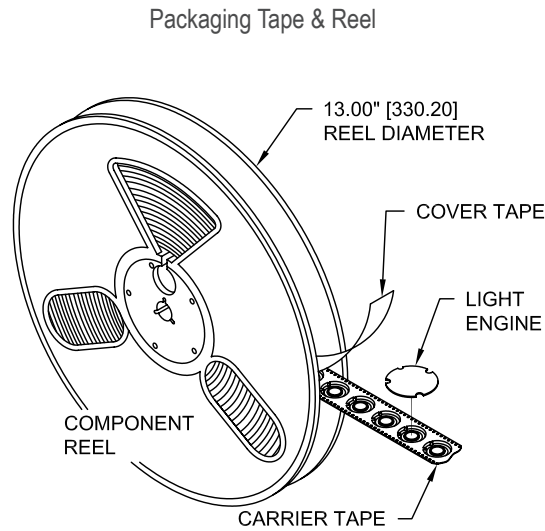

Figure 14.  
250 parts are on the reel.

# CARRIER TAPE

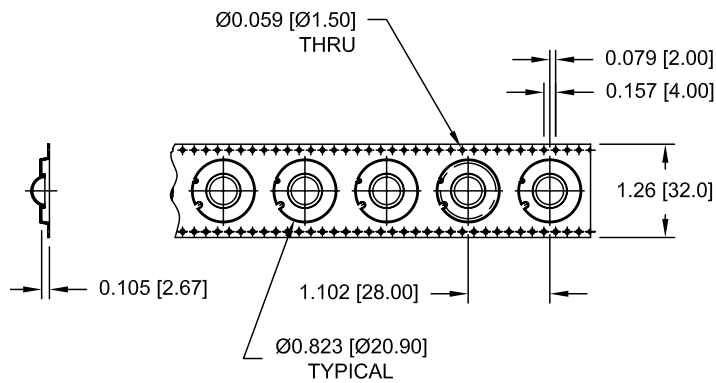

Figure 15.  
Carrier Tape made from ESD dissipative material.

Units: Inches [millimeters]

# PACKAGING TRAY

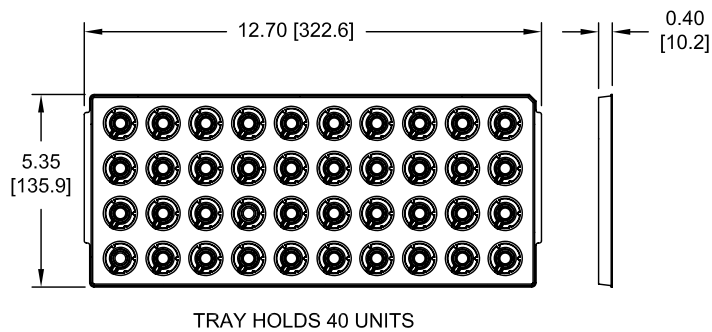

Figure 16.  
Packaging Trays made from static dissipative material.

Units: Inches [millimeters]

# PATENTS, CONNECTIONS, ASSEMBLY, AND PACKAGING

## PATENTS

Lamina's light engines may be covered by pending patents and/or one or more of the following U.S. and/or International patents 5876536, 6709749 B, 595880, 6017642, 5565262, 5681444, 5653834, 5581876, 5847935, 5514451, 5747931, 5925203, 5725808, 5929510, 5858145, 5866240, 5953203, 6055151, 614076, 6011330, 6399230, 6914501, 6168490, 6191934, 614075, 6160469, 6300267, 6471805, 6518502, 6739047, 6720859, 6759940, 6518502, 6670856 B1, 6720859, 6713862 B2, WO 00/47399, WO 00/26152, WO 98/19339, 5082804, ZL99808762.9, 69623930, 69628549, 69629572, 805785, 69628549, 843621, 932500, 805785, 812258, 843621, 932500, 805785, 812258, 843621, 932500, 3327556, 3267299, 3226281, 3405545, 320630, 295695, 284068, 546471, 805785, 812258, 843621, 6455930, 6759940, 6713862, 7095053, 7098483.

## ELECTRICAL CONNECTIONS

LED light engines are available with or without Lamina's EZConnect board. EZConnect adapter boards have AMP connectors for solderless connections to Lamina's wiring harness.

As with many electrical devices, non-acid RMA type solder flux should be used to prepare the solder pads before application of solder. Ensure proper strain relief of wires attached to the light engine to prevent damage to the light engines solder pads. For more information refer to Lamina's connection application note AN-05 which can be found on the website at [www.laminalighting.com](http://www.laminalighting.com).

Functional test: Parts may be tested using a constant current source set at 25% of Drive Current for no more than two seconds without heat sink.

1. Optical and electrical specifications are given for the specified drive @ 25°C junction temperature.
2. When using constant current LED drivers with high compliance voltage (Advance, LEDworks, etc. or a custom driver) the output of the supply must be connected to the part before power is applied to the input of the supply.

## ASSEMBLY RECOMMENDATIONS

Lamina's Series Light Engines are designed for attachment to a heat sink with conductive epoxy, or screw down for flange mount devices with thermal grease in the joint. For attachment using screws, a 2-56 UNC round head or metric equivalent M2 X 0.4 cheese head screw, 18-8 SS is recommended. When mounting the light engine, position the three screws in the center of each of the three slots. Tighten the three screws evenly, first to about 0.89 inch pounds (10 Newton-centimeter), and then tighten each to a maximum torque of 4 inch pounds (45 Newton-centimeter). Flatness requirement of the surface that the light engine is mounted to is 0.001 inch/inch (1mm/meter).

All specifications are based on mounting the LED array to a heat sink using the specified hardware and thermal grease (e.g. Wakefield P/N 120). The heat sink must meet the specified flatness requirement. Mounting using screws and thermal tape may damage the device.

## RECEIVING PARTS AND PACKAGING TRAYS

Your parts will arrive in either custom fitted trays or on easy to use tape and reel packaging. This packaging was designed to provide the necessary protection during shipment and to take up the least amount of space in your storage area.

### Notes

1. This product uses silicone materials for superior optical performance. Do not expose the part to fluids that may react with silicone compounds. See Dow Chemical Form 45-0113D-01, Silicone Fluid Resistance Guide.
2. Ray trace models are available upon request.
3. Lamina may make process or materials changes affecting the performance or other characteristics of our products. These products supplied after such changes will continue to meet published specifications, but may not be identical to product supplied as samples or under prior orders.
4. All specifications are based on mounting the LED array to a heat sink using the specified hardware and thermal grease Wakefield P/N 120. The heat sink must meet the specified flatness requirement. Mounting using screws and thermal tape may damage the device.

# RoHS AND WARRANTY

## LAMINA LIGHT ENGINES COMPLY WITH RoHS RESTRICTIONS

Lamina Light Engines are compliant with all of the criteria proposed by the European RoHS Directive 2002/95/EC for hazardous material content in electronic and electrical equipment as listed in Annex 1A and 1B of the WEEE Directive.

In addition to containing no mercury, Lamina's LED Light Engines have the following environmental advantages over traditional light sources:

- High energy efficiency
- Long lifetime
- Fully dimmable
- Very low IR and UV radiation

For attachment of electrical connections Lamina recommends the use of lead-free solder.

## WARRANTY STATEMENT

Lamina Lighting, Incorporated (Seller) extends warranty on goods produced by the Seller for one (1) year from original date of shipment, that the goods sold hereunder are new and free from substantive defects in workmanship and materials. This warranty extends only to the Buyer and not to indirect purchasers or users. Seller's liability under the foregoing warranty is limited to replacement of goods or repair of defects or refund of the purchase price at the Seller's sole option. The above warranty does not apply to defects resulting from the improper or inadequate maintenance, unauthorized modification, improper use or operation outside of Seller's specifications for the product, abuse, neglect or accident. THE ABOVE WARRANTY IS EXCLUSIVE AND NO OTHER WARRANTY, WHETHER WRITTEN OR ORAL, IS EXPRESSED OR IMPLIED. LAMINA LIGHTING INCORPORATED SPECIFICALLY DISCLAIMS THE IMPLIED WARRANTIES OF MERCHANTABILITY AND FITNESS FOR A PARTICULAR PURPOSE. - LAMINA LIGHTING INCORPORATED - June 21, 2006.



---

©2008 Lamina Lighting Incorporated. Lamina is a registered trademark and the Lamina logo, Atlas, Titan, TitanTurbo, SöL, TruColor, and EZ-Connect are trademarks of Lamina Lighting Incorporated. All other trademarks mentioned are the property of their respective owners.