

## Features

- \* Meet ROHS, Green Product.
- \* Dual color chip LED.
- \* Ultra bright InGaN / AlInGaP Chip LED.
- \* Package in 8mm tape on 7" diameter reels.
- \* EIA STD package.
- \* I.C. compatible.
- \* Compatible with automatic placement equipment.
- \* Compatible with infrared and vapor phase reflow solder process.

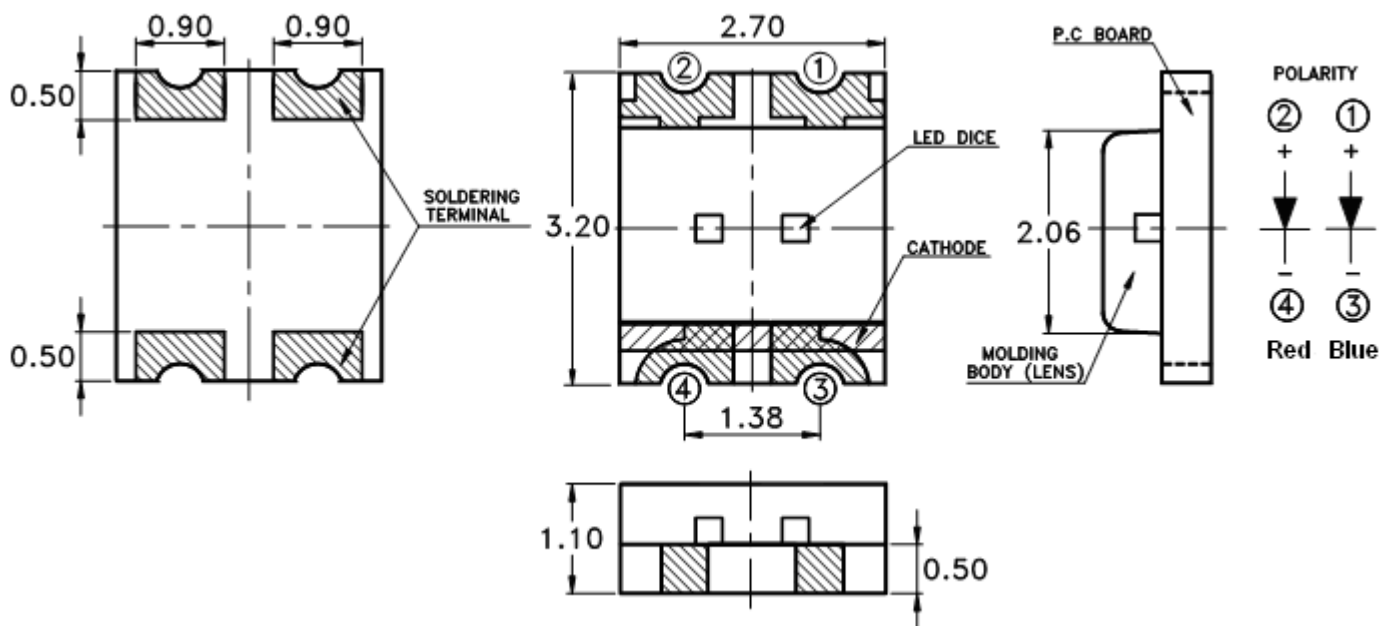

## Package Dimensions



## Devices

| Part No.        | Lens        | Source Color | Pin Assignment |
|-----------------|-------------|--------------|----------------|
| LTST-C155TBJRKT | Water Clear | InGaN Blue   | 1,3            |
|                 |             | AlInGaP Red  | 2,4            |

### Notes:

1. All dimensions are in millimeters (inches).
2. Tolerance is  $\pm 0.10$  mm (.004") unless otherwise noted.

**Absolute Maximum Ratings At Ta=25°C**

| Parameter  | LTST-C155TBJRKT     |     | Unit  |
|--|---------------------|-----|-------|
|  | Blue                | Red |       |
| Power Dissipation  | 76                  | 75  | mW    |
| Peak Forward Current<br>(1/10 Duty Cycle, 0.1ms Pulse Width) | 100                 | 80  | mA    |
| DC Forward Current   | 20                  | 30  | mA    |
| Derating Linear From 25°C                                    | 0.25                | 0.4 | mA/°C |
| Reverse Voltage <sup>Note A</sup>                            | 5                   | 5   | V     |
| Operating Temperature Range                                  | -20°C to + 80°C     |     |       |
| Storage Temperature Range                                    | -30°C to + 85°C     |     |       |
| Infrared Soldering Condition                                 | 260°C For 5 Seconds |     |       |

Note A: Reverse Voltage can't be continued operating

### Suggestion Profile:

#### (1) Suggestion IR Reflow Profile For Normal Process

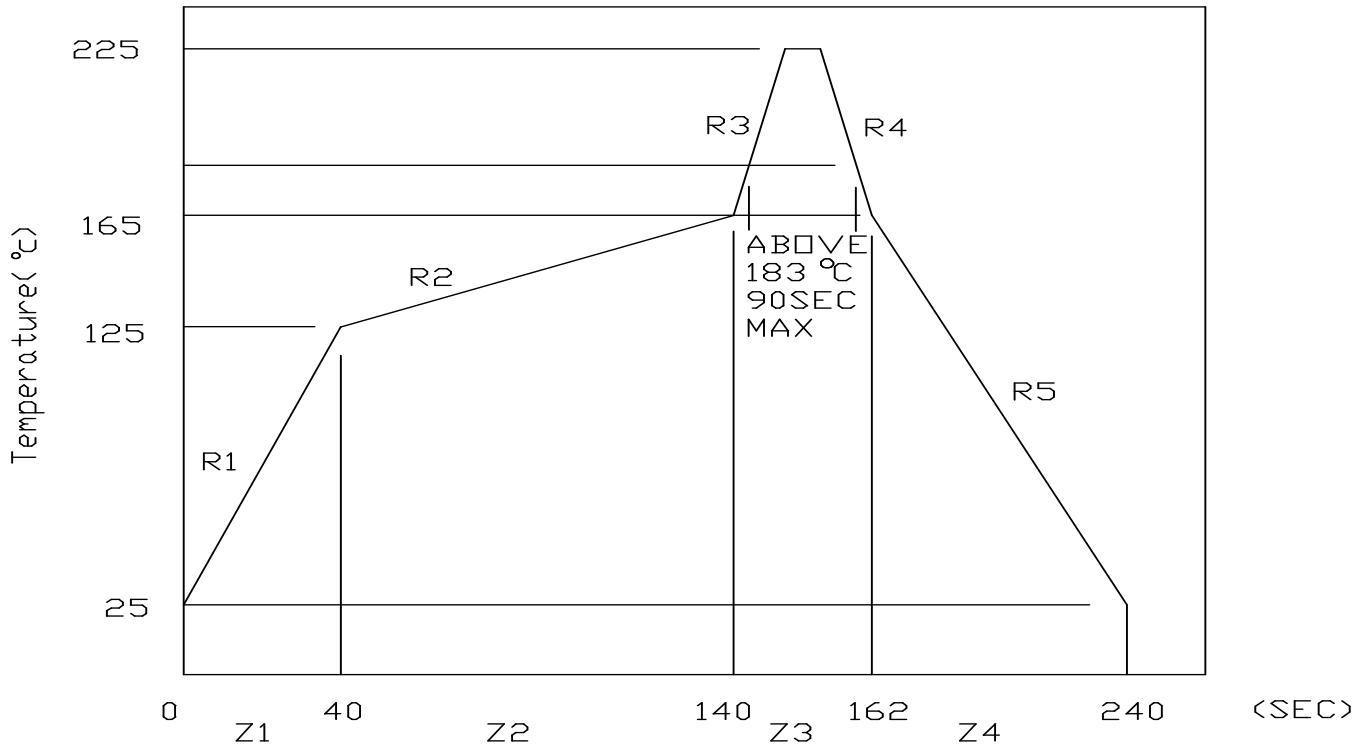

#### (2) Suggestion IR Reflow Profile For Pb Free Process

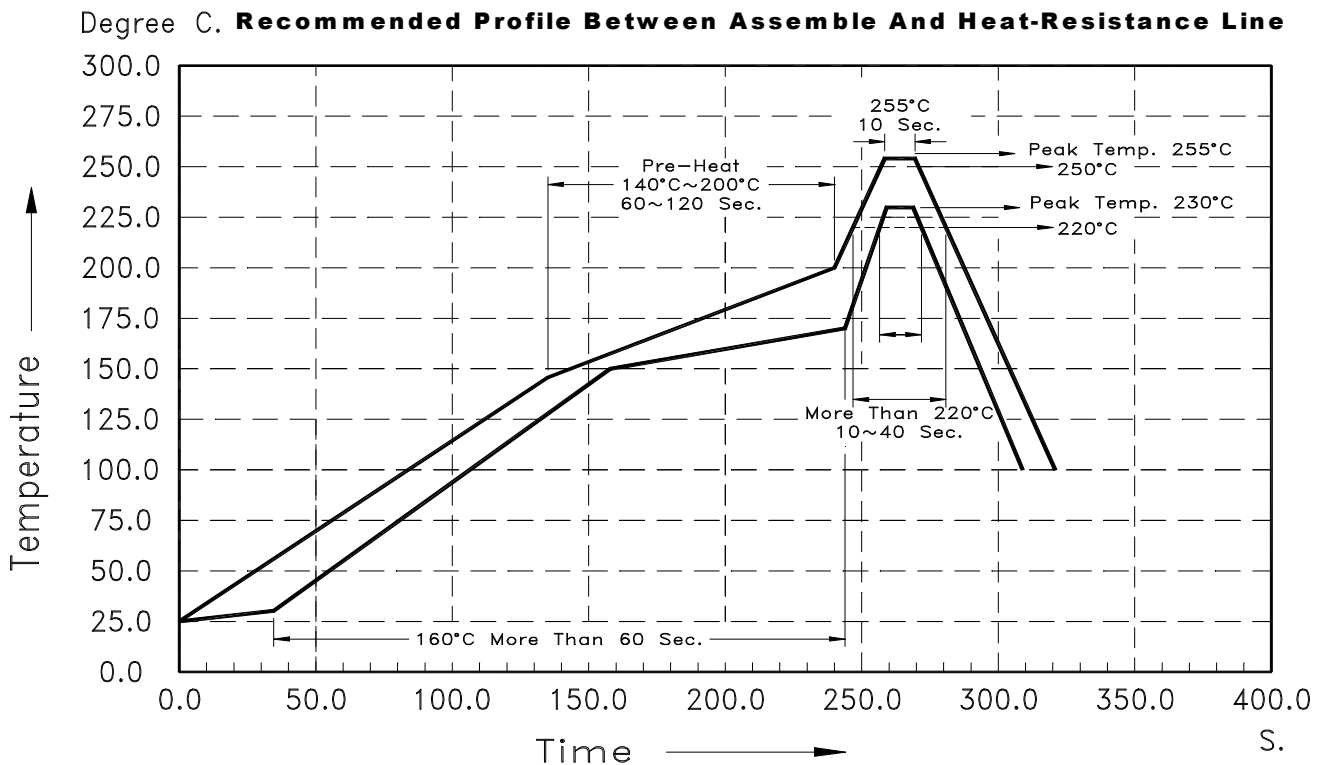

The Profile is available that must to use SnAg (x=3.3~3.8) Cu (y=0.2~0.7) solder paste

### Electrical / Optical Characteristics At Ta=25°C

| Parameter                | Symbol |      | LTST-C155TBJRKT |       | Unit | Test Condition            |
|--------------------------|--------|------|-----------------|-------|------|---------------------------|
|                          |        |      | Blue            | Red   |      |                           |
| Luminous Intensity       | IV     | MIN. | 18.0            | 18.0  | mcd  | IF =20mA<br>Note 1        |
|                          |        | TYP. |                 | -     |      |                           |
|                          |        | MAX. | 112             | 112.0 |      |                           |
| Viewing Angle            | 2θ1/2  | TYP. | 130             | 130   | deg  | Note 2 (Fig.6)            |
| Peak Emission Wavelength | λP     | TYP. | 468             | 639   | nm   | Measurement @Peak (Fig.1) |
| Dominant Wavelength      | λd     | TYP. | 470             | 631   | nm   | IF =20mA<br>Note 3        |
| Spectral Line Half-Width | Δλ     | TYP. | 25              | 15    | nm   |                           |
| Forward Voltage          | VF     | TYP. | 3.30            | 2.00  | V    | IF =20mA                  |
|                          |        | MAX. | 3.80            | 2.40  |      |                           |
| Reverse Current          | IR     | MAX. | 10              | 10    | μA   | VR = 5V                   |
| Capacitance              | C      | TYP. | -               | 40    | PF   | VF=0,f=1MHZ               |

Notes: 1. Luminous intensity is measured with a light sensor and filter combination that approximates the CIE eye-response curve.

2.  $\theta$  1/2 is the off-axis angle at which the luminous intensity is half the axial luminous intensity.

3. The dominant wavelength,  $\lambda$  d is derived from the CIE chromaticity diagram and represents the single wavelength which defines the color of the device.

4. Caution in ESD:

Static Electricity and surge damages the LED. It is recommend to use a wrist band or anti-electrostatic glove when handling the LED. All devices, equipment and machinery must be properly grounded.

**Bin Code List**

| Luminous Intensity |      | Color : <u>Blue</u> , Unit : mcd @20mA |  |
|--------------------|------|--|--|
| Bin Code           | Min. | Max.                                   |  |
| M                  | 18.0 | 28.0                                   |  |
| N                  | 28.0 | 45.0                                   |  |
| P                  | 45.0 | 71.0                                   |  |
| Q                  | 71.0 | 112.0                                  |  |

Tolerance on each Intensity bin is +/-15%

| Luminous Intensity |      | Color : <u>Red</u> , Unit : mcd @20mA |  |
|--------------------|------|---------------------------------------|--|
| Bin Code           | Min. | Max.                                  |  |
| M                  | 18.0 | 28.0                                  |  |
| N                  | 28.0 | 45.0                                  |  |
| P                  | 45.0 | 71.0                                  |  |
| Q                  | 71.0 | 112.0                                 |  |

Tolerance on each Intensity bin is +/-15%

### Typical Electrical / Optical Characteristics Curves

(25°C Ambient Temperature Unless Otherwise Noted)

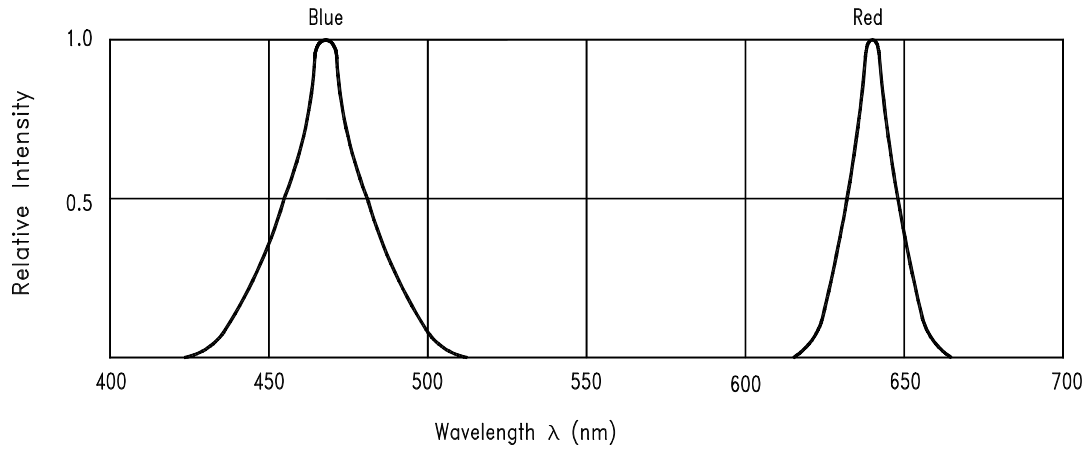

Fig.1 Relative Intensity vs. Wavelength

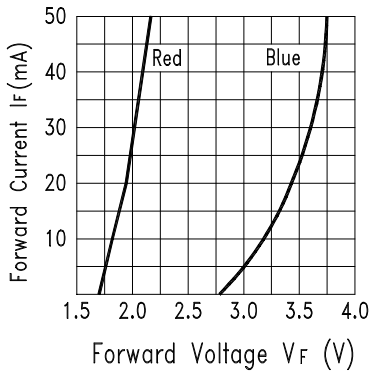

Fig.2 Forward Current vs. Forward Voltage

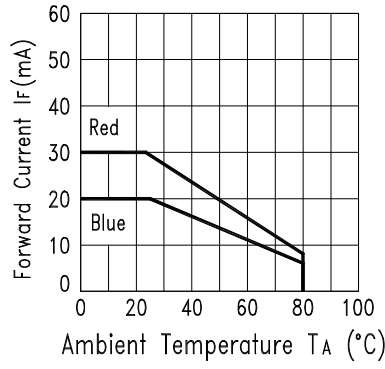

Fig.3 Forward Current Derating Curve

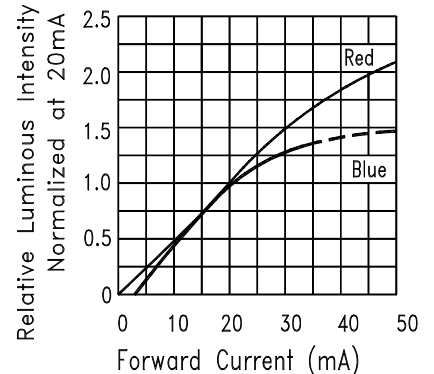

Fig.4 Relative Luminous Intensity vs. Forward Current

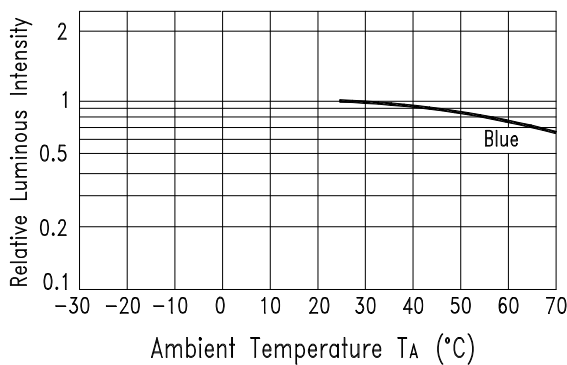

Fig.5 Luminous Intensity vs.

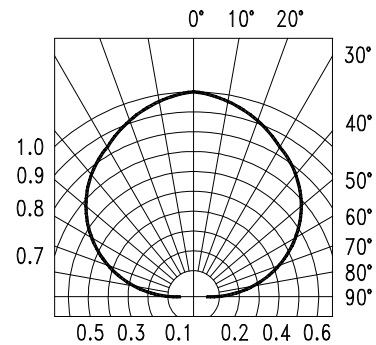

Fig.6 Spatial Distribution

### Cleaning

Do not use unspecified chemical liquid to clean LED they could harm the package.

If clean is necessary, immerse the LED in ethyl alcohol or in isopropyl alcohol at normal temperature for less one minute.

### Suggest Soldering Pad Dimensions

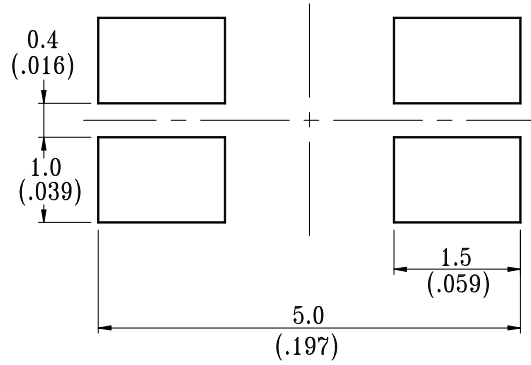

### Package Dimensions Of Tape And Reel

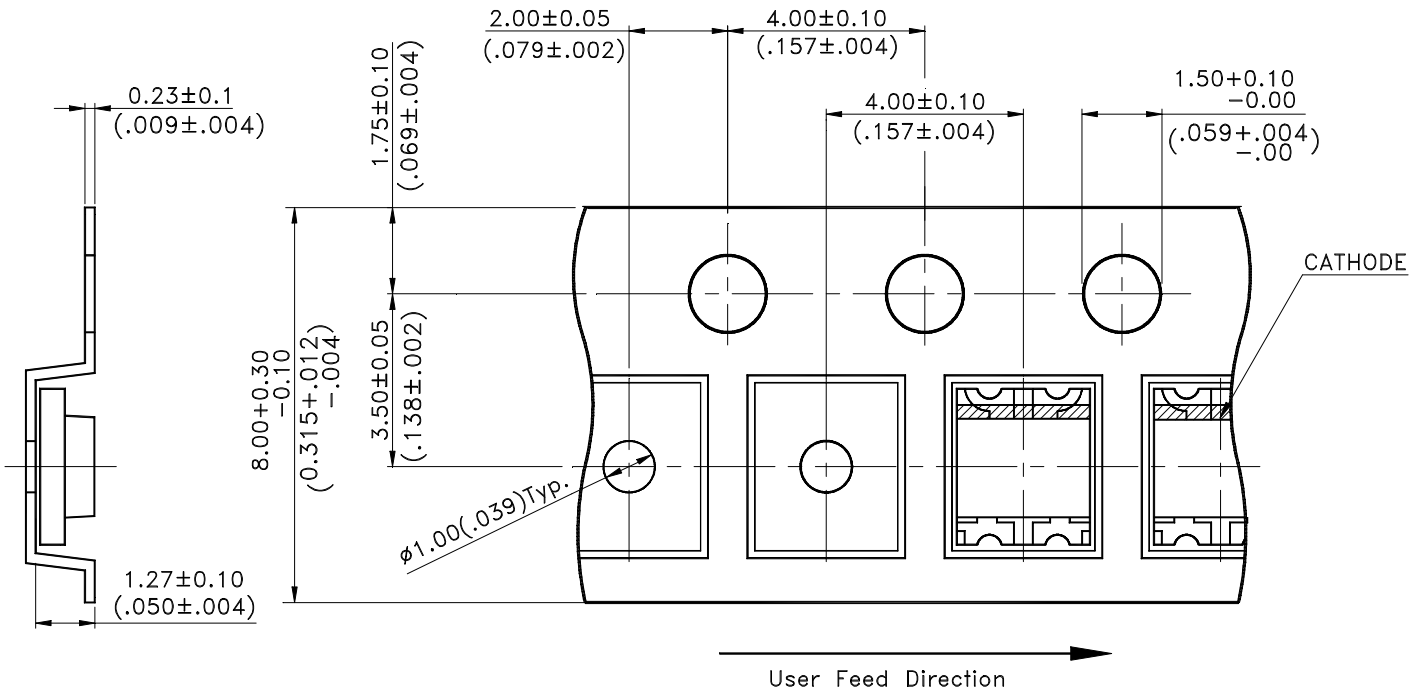

### Notes:

1. All dimensions are in millimeters (inches).

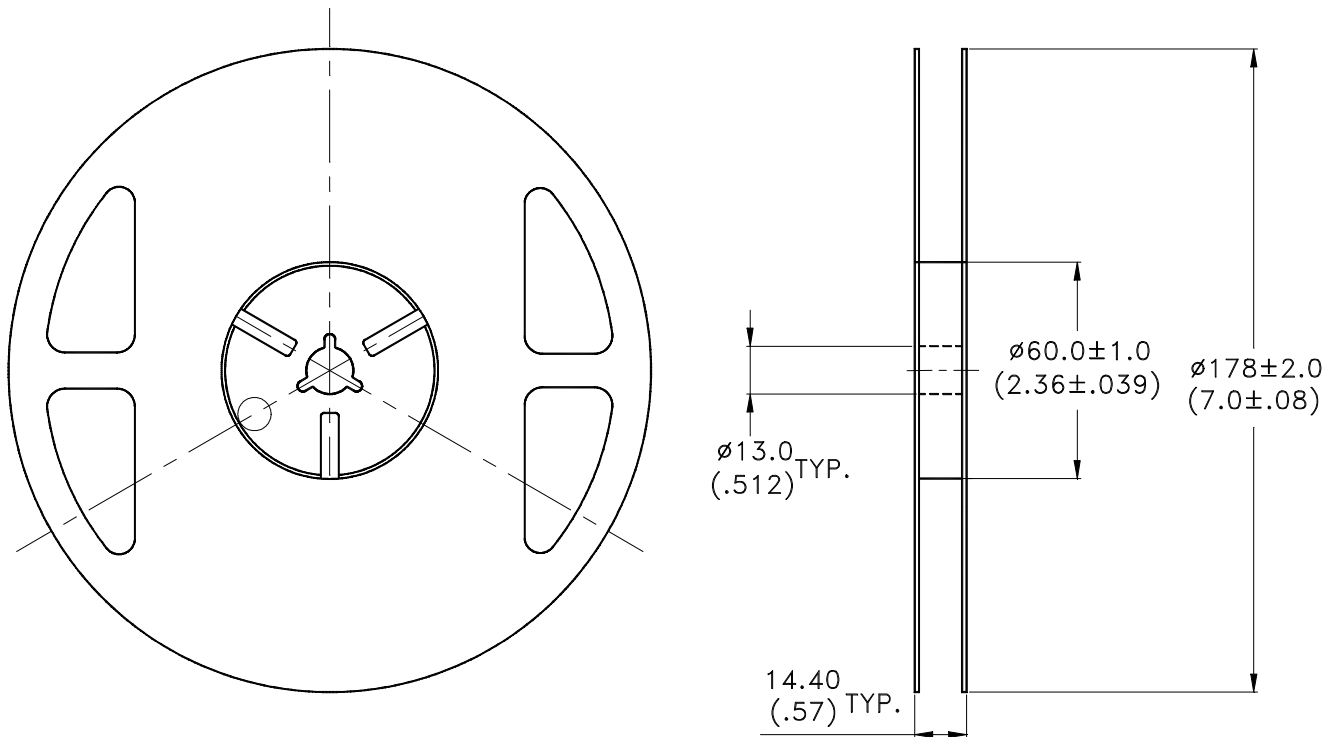

## Notes:

1. Empty component pockets sealed with top cover tape.
2. 7 inch reel-3000 pieces per reel.
3. Minimum packing quantity is 500 pcs for remainders.
4. The maximum number of consecutive missing lamps is two.
5. In accordance with ANSI/EIA 481-1-A-1994 specifications.



## CAUTIONS

### 1. Application

The LEDs described here are intended to be used for ordinary electronic equipment (such as office equipment, communication equipment and household applications). Consult Liteon's Sales in advance for information on applications in which exceptional reliability is required, particularly when the failure or malfunction of the LEDs may directly jeopardize life or health (such as in aviation, transportation, traffic control equipment, medical and life support systems and safety devices).

### 2. Storage

The storage ambient for the LEDs should not exceed 30°C temperature or 70% relative humidity.

It is recommended that LEDs out of their original packaging are IR-reflowed within one week.

For extended storage out of their original packaging, it is recommended that the LEDs be stored in a sealed container with appropriate desiccant, or in a desiccators with nitrogen ambient.

LEDs stored out of their original packaging for more than a week should be baked at about 60 deg C for at least 24 hours before solder assembly.

### 3. Cleaning

Use alcohol-based cleaning solvents such as isopropyl alcohol to clean the LED if necessary.

### 4. Soldering

Recommended soldering conditions:

| Reflow soldering |               | Wave Soldering |              | Soldering iron |                 |
|------------------|---------------|----------------|--------------|----------------|-----------------|
| Pre-heat         | 120~150°C     | Pre-heat       | 100°C Max.   | Temperature    | 300°C Max.      |
| Pre-heat time    | 120 sec. Max. | Pre-heat time  | 60 sec. Max. | Soldering time | 3 sec. Max.     |
| Peak temperature | 260°C Max.    | Solder wave    | 260°C Max.   |                | (one time only) |
| Soldering time   | 5 sec. Max.   | Soldering time | 10 sec. Max. |                |                 |

### 5. Drive Method

An LED is a current-operated device. In order to ensure intensity uniformity on multiple LEDs connected in parallel in an application, it is recommended that a current limiting resistor be incorporated in the drive circuit, in series with each LED as shown in Circuit A below.

**Circuit model A**

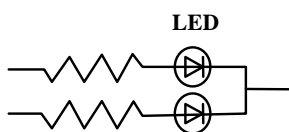

(A) Recommended circuit.

**Circuit model B**

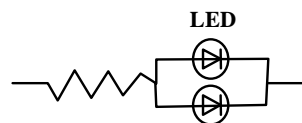

(B) The brightness of each LED might appear different due to the differences in the I-V characteristics of those LEDs.

### 6. ESD (Electrostatic Discharge)

Static Electricity or power surge will damage the LED.

Suggestions to prevent ESD damage:

- Use of a conductive wrist band or anti-electrostatic glove when handling these LEDs.
- All devices, equipment, and machinery must be properly grounded.
- Work tables, storage racks, etc. should be properly grounded.
- Use ion blower to neutralize the static charge which might have built up on surface of the LED's plastic lens as a result of friction between LEDs during storage and handling.

ESD-damaged LEDs will exhibit abnormal characteristics such as high reverse leakage current, low forward voltage, or “ no lightup ” at low currents.

To verify for ESD damage, check for “ lightup ” and Vf of the suspect LEDs at low currents.

The Vf of “ good ” LEDs should be  $>2.0V@0.1mA$  for InGaN product and  $>1.4V@0.1mA$  for AlInGaP product.

### 7. Reliability Test

| Classification     | Test Item   | Test Condition   | Reference Standard  |
|--------------------|---|--|---|
| Endurance Test     | Operation Life  | Ta= Under Room Temperature As Per Data Sheet<br>Maximum Rating<br>*Test Time= 1000HRS (-24HRS,+72HRS)  | MIL-STD-750D:1026<br>MIL-STD-883D:1005<br>JIS C 7021:B-1                      |
|                    | High Temperature High Humidity Storage  | IR-Reflow In-Board, 2 Times<br>Ta= $65\pm 5^{\circ}C$ , RH= 90~95%<br>*Test Time= 240HRS $\pm$ 2HRS  | MIL-STD-202F:103B<br>JIS C 7021:B-11  |
|                    | High Temperature Storage  | Ta= $105\pm 5^{\circ}C$<br>*Test Time= 1000HRS (-24HRS,+72HRS)   | MIL-STD-883D:1008<br>JIS C 7021:B-10  |
|                    | Low Temperature Storage   | Ta= $-55\pm 5^{\circ}C$<br>*Test Time=1000HRS (-24HRS,+72HRS)  | JIS C 7021:B-12   |
| Environmental Test | Temperature Cycling   | $105^{\circ}C \sim 25^{\circ}C \sim -55^{\circ}C \sim 25^{\circ}C$<br>30mins 5mins 30mins 5mins<br>10 Cycles   | MIL-STD-202F:107D<br>MIL-STD-750D:1051<br>MIL-STD-883D:1010<br>JIS C 7021:A-4 |
|                    | Thermal Shock   | IR-Reflow In-Board, 2 Times<br>$85 \pm 5^{\circ}C \sim -40^{\circ}C \pm 5^{\circ}C$<br>10mins 10mins 10 Cycles   | MIL-STD-202F:107D<br>MIL-STD-750D:1051<br>MIL-STD-883D:1011                   |
|                    | Solder Resistance   | T.sol= $260 \pm 5^{\circ}C$<br>Dwell Time= $10 \pm 1$ secs   | MIL-STD-202F:210A<br>MIL-STD-750D:2031<br>JIS C 7021:A-1                      |
|                    | IR-Reflow Normal Process  | Ramp-up rate( $183^{\circ}C$ to Peak) $+3^{\circ}C/$ second max<br>Temp. maintain at $125(\pm 25)^{\circ}C$ 120 seconds max<br>Temp. maintain above $183^{\circ}C$ 60-150 seconds<br>Peak temperature range $235^{\circ}C +5/-0^{\circ}C$<br>Time within $5^{\circ}C$ of actual Peak Temperature (tp)<br>10-30 seconds<br>Ramp-down rate $+6^{\circ}C/$ second max | MIL-STD-750D:2031.2<br>J-STD-020C   |
|                    | IR-Reflow Pb Free Process   | Ramp-up rate( $217^{\circ}C$ to Peak) $+3^{\circ}C/$ second max<br>Temp. maintain at $175(\pm 25)^{\circ}C$ 180 seconds max<br>Temp. maintain above $217^{\circ}C$ 60-150 seconds<br>Peak temperature range $260^{\circ}C +0/-5^{\circ}C$<br>Time within $5^{\circ}C$ of actual Peak Temperature (tp)<br>20-40 seconds<br>Ramp-down rate $+6^{\circ}C/$ second max | MIL-STD-750D:2031.2<br>J-STD-020C   |
| Solderability      | T.sol= $235 \pm 5^{\circ}C$<br>Immersion time $2\pm 0.5$ sec<br>Immersion rate $25\pm 2.5$ mm/sec<br>Coverage $\geq 95\%$ of the dipped surface | MIL-STD-202F:208D<br>MIL-STD-750D:2026<br>MIL-STD-883D:2003<br>IEC 68 Part 2-20<br>JIS C 7021:A-2  |   |

### 8. Others

The appearance and specifications of the product may be modified for improvement without prior notice.

**9. Suggested Checking List**

## Training and Certification

1. Everyone working in a static-safe area is ESD-certified?
2. Training records kept and re-certification dates monitored?

## Static-Safe Workstation &amp; Work Areas

1. Static-safe workstation or work-areas have ESD signs?
2. All surfaces and objects at all static-safe workstation and within 1 ft measure less than 100V?
3. All ionizer activated, positioned towards the units?
4. Each work surface mats grounding is good?

## Personnel Grounding

1. Every person (including visitors) handling ESD sensitive (ESDS) items wears wrist strap, heel strap or conductive shoes with conductive flooring?
2. If conductive footwear used, conductive flooring also present where operator stand or walk?
3. Garments, hairs or anything closer than 1 ft to ESD items measure less than 100V\*?
4. Every wrist strap or heel strap/conductive shoes checked daily and result recorded for all DLs?
5. All wrist strap or heel strap checkers calibration up to date?

Note: \*50V for Blue LED.

## Device Handling

1. Every ESDS items identified by EIA-471 labels on item or packaging?
2. All ESDS items completely inside properly closed static-shielding containers when not at static-safe workstation?
3. No static charge generators (e.g. plastics) inside shielding containers with ESDS items?
4. All flexible conductive and dissipative package materials inspected before reuse or recycles?

## Others

1. Audit result reported to entity ESD control coordinator?
2. Corrective action from previous audits completed?
3. Are audit records complete and on file?