



SGM2031

Low Power, Low Dropout, RF-Linear Regulators

GENERAL DESCRIPTION

The SGM2031 series low-power, low-dropout, CMOS linear voltage regulators operate from a 2.5V to 5.5V input voltage in an ultra small package. They are the perfect choice for low voltage, low power applications. A low ground current makes this part attractive for battery operated power systems. The SGM2031 series also offer ultra low dropout voltage to prolong battery life in portable electronics. Systems requiring a quiet voltage source, such as RF applications, will benefit from the SGM2031 series' low output noise and high PSRR.

Other features include a 10nA logic-controlled shutdown mode, foldback current limit and thermal shut-down protection.

The SGM2031 is available in Green UTDFN-1×1-4L package. It operates over an ambient temperature range of -40°C to +85°C.

TYPICAL APPLICATION

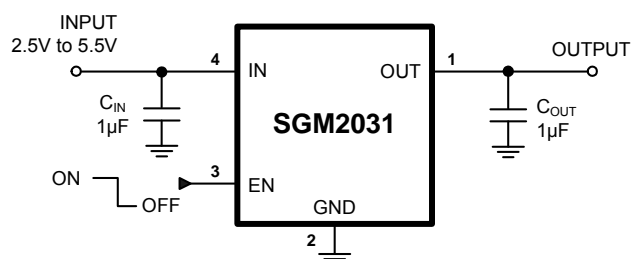

FEATURES

- Low Dropout Voltage
- Thermal-Overload Protection
- Output Current Limit
- High PSRR (72dB at 1kHz)
- 10nA Logic-Controlled Shutdown
- Available in Multiple Output Voltage Versions
- Fixed Outputs of 1.2V, 1.5V, 1.8V, 2.5V, 2.6V, 2.8V, 2.85V, 3.0V and 3.3V
- -40°C to +85°C Operating Temperature Range
- Available in Green UTDFN-1×1-4L Package

APPLICATIONS

Cellular Telephones
Cordless Telephones
PHS Telephones
PCMCIA Cards
Modems
MP3 Player
Hand-Held Instruments
Palmtop Computers
Electronic Planners
Portable/Battery-Powered Equipment

PACKAGE/ORDERING INFORMATION

MODEL	V _{OUT} (V)	PIN-PACKAGE	ORDERING NUMBER	PACKAGE MARKING	PACKAGE OPTION
SGM2031-1.2	1.2V	UTDFN-1x1-4L	SGM2031-1.2YUDH4G/TR	64	Tape and Reel, 10000
SGM2031-1.5	1.5V	UTDFN-1x1-4L	SGM2031-1.5YUDH4G/TR	9F	Tape and Reel, 10000
SGM2031-1.8	1.8V	UTDFN-1x1-4L	SGM2031-1.8YUDH4G/TR	51	Tape and Reel, 10000
SGM2031-2.5	2.5V	UTDFN-1x1-4L	SGM2031-2.5YUDH4G/TR	A0	Tape and Reel, 10000
SGM2031-2.6	2.6V	UTDFN-1x1-4L	SGM2031-2.6YUDH4G/TR	B8	Tape and Reel, 10000
SGM2031-2.8	2.8V	UTDFN-1x1-4L	SGM2031-2.8YUDH4G/TR	52	Tape and Reel, 10000
SGM2031-2.85	2.85V	UTDFN-1x1-4L	SGM2031-2.85YUDH4G/TR	B9	Tape and Reel, 10000
SGM2031-3.0	3.0V	UTDFN-1x1-4L	SGM2031-3.0YUDH4G/TR	53	Tape and Reel, 10000
SGM2031-3.3	3.3V	UTDFN-1x1-4L	SGM2031-3.3YUDH4G/TR	57	Tape and Reel, 10000

NOTE: Order number is defined as the follow:

ORDER NUMBER

SGM2031 - X X X G / TR

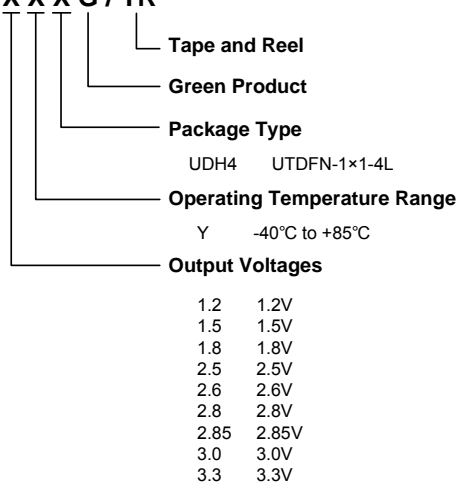

SGM2031

ABSOLUTE MAXIMUM RATINGS

IN to GND.....	-0.3V to 6V
Output Short-Circuit Duration	Infinite
EN to GND.....	-0.3V to V_{IN}
OUT to GND.....	-0.3V to $(V_{IN} + 0.3V)$
Power Dissipation, P_D @ $T_A = 25^\circ C$	
UTDFN-1x1-4L.....	400mW
Package Thermal Resistance	
UTDFN-1x1-4L, θ_{JA}	280°C/W
Operating Temperature Range.....	-40°C to +85°C
Junction Temperature.....	150°C
Storage Temperature Range.....	-65°C to +150°C
Lead Temperature (Soldering, 10s).....	260°C
ESD Susceptibility	
HBM.....	4000V
MM.....	400V

NOTE:

Stresses beyond those listed under “Absolute Maximum Ratings” may cause permanent damage to the device. These are stress ratings only, and functional operation of the device at these or any other conditions beyond those indicated in the operational sections of the specifications is not implied. Exposure to absolute maximum rating conditions for extended periods may affect device reliability.

CAUTION

This integrated circuit can be damaged by ESD if you don't pay attention to ESD protection. SGMICRO recommends that all integrated circuits be handled with appropriate precautions. Failure to observe proper handling and installation procedures can cause damage. ESD damage can range from subtle performance degradation to complete device failure. Precision integrated circuits may be more susceptible to damage because very small parametric changes could cause the device not to meet its published specifications.

SGMICRO reserves the right to make any change in circuit design, specification or other related things if necessary without notice at any time. Please contact SGMICRO sales office to get the latest datasheet.

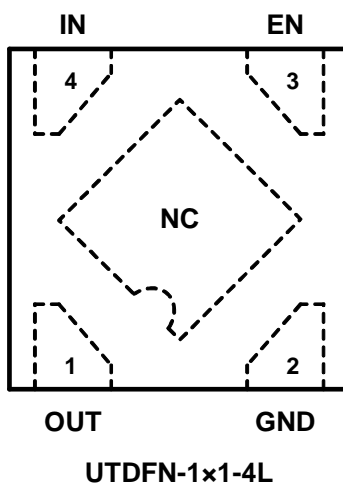
PIN CONFIGURATION (TOP VIEW)**PIN DESCRIPTION**

PIN	NAME	FUNCTION
1	OUT	Regulator Output.
2	GND	Ground.
3	EN	Shutdown Input. A logic low reduces the supply current to 10nA. Connect to IN for normal operation.
4	IN	Regulator Input. Supply voltage can range from 2.5V to 5.5V. Bypass with a 1 μ F capacitor to GND.
Exposed Pad	NC	No Connection.

ELECTRICAL CHARACTERISTICS(V_{IN} = V_{OUT(NOMINAL)} + 0.5V⁽¹⁾, Full = -40°C to +85°C, unless otherwise noted.)

PARAMETER	SYMBOL	CONDITIONS	TEMP	MIN	TYP	MAX	UNITS	
Input Voltage	V _{IN}		+25°C	2.5		5.5	V	
Output Voltage Accuracy ⁽¹⁾		I _{OUT} = 0.1mA	+25°C	-3		+3	%	
Maximum Output Current ^{(1), (5)}			+25°C	250			mA	
Current Limit ⁽¹⁾	I _{LIM}		+25°C	260			mA	
Ground Pin Current	I _Q	No Load, EN = 2V	+25°C		95	200	μA	
Dropout Voltage ⁽²⁾		I _{OUT} = 1mA	+25°C		0.9		mV	
		I _{OUT} = 250mA			230	400		
Line Regulation ⁽¹⁾	ΔV _{LNR}	V _{IN} = 2.5V or (V _{OUT} + 0.5V) to 5.5V, I _{OUT} = 1mA	+25°C		0.02	0.05	%/V	
Load Regulation	ΔV _{LDR}	I _{OUT} = 0.1mA to 250mA, C _{OUT} = 1μF, V _{OUT} > 2V	+25°C		0.002	0.005	%/mA	
		I _{OUT} = 0.1mA to 250mA, C _{OUT} = 1μF, V _{OUT} ≤ 2V			0.004	0.008		
Output Voltage Noise	e _n	f = 10Hz to 100kHz, C _{OUT} = 10μF	+25°C		140		μV _{RMS}	
Power Supply Rejection Ratio	PSRR	I _{LOAD} = 50mA, C _{OUT} = 1μF, V _{IN} = V _{OUT} + 1V	f = 217Hz	+25°C		72		dB
			f = 1kHz	+25°C		72		dB

SHUTDOWN⁽³⁾

EN Input Threshold	V _{IH}	V _{IN} = 2.5V to 5.5V, V _{EN} = -0.3V to V _{IN}	Full	1.5			V
	V _{IL}		Full			0.3	
EN Input Bias Current	I _{B(SHDN)}	EN = 0V and EN = 5.5V	+25°C		0.01	1	μA
			Full		0.01		
Shutdown Supply Current	I _{Q(SHDN)}	EN = 0.4V	+25°C		0.01	1	μA
			Full		0.01		
Shutdown Exit Delay ⁽⁴⁾		C _{OUT} = 1μF, No Load	+25°C		10		μs

THERMAL PROTECTION

Thermal Shutdown Temperature	T _{SHDN}				150		°C
Thermal Shutdown Hysteresis	ΔT _{SHDN}				15		°C

NOTES:

- V_{IN} = V_{OUT(NOMINAL)} + 0.5V or 2.5V, whichever is greater.
- The dropout voltage is defined as V_{IN} - V_{OUT}, when V_{OUT} is 100mV below the value of V_{OUT} for V_{IN} = V_{OUT} + 0.5V.
(Only applicable for V_{OUT} = +2.5V to +5.0V.)
- V_{EN} = -0.3V to V_{IN}
- Time needed for V_{OUT} to reach 90% of final value.
- Maximum output current is affected by PCB layout, size of metal trace, the thermal conduction path between metal layers, operating temperature and the other environment factor of system.

TYPICAL PERFORMANCE CHARACTERISTICS

$V_{IN} = V_{OUT(NOMINAL)} + 0.5V$ or $2.5V$ (whichever is greater), $C_{IN} = 1\mu F$, $C_{OUT} = 1\mu F$, $T_A = +25^\circ C$, unless otherwise noted.

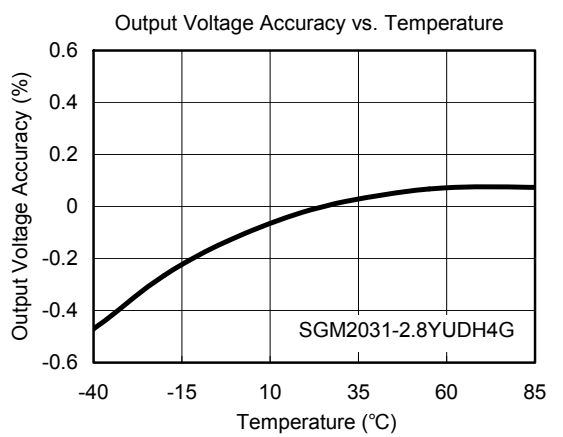
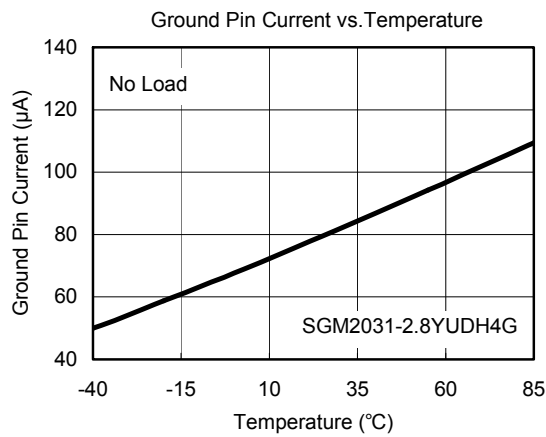
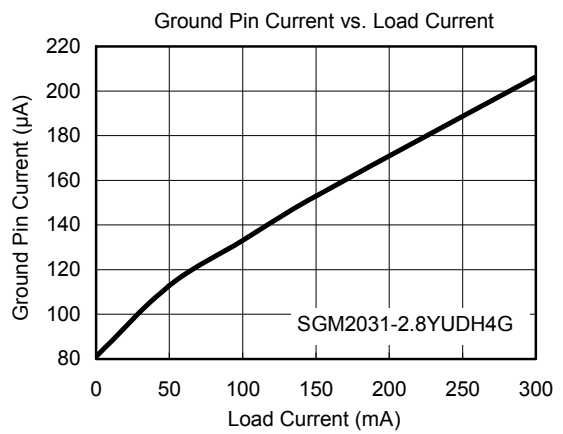
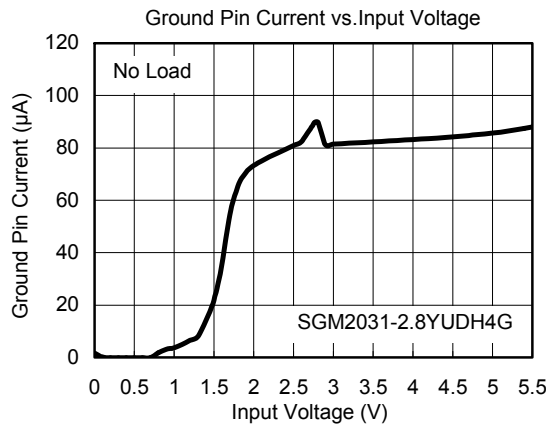
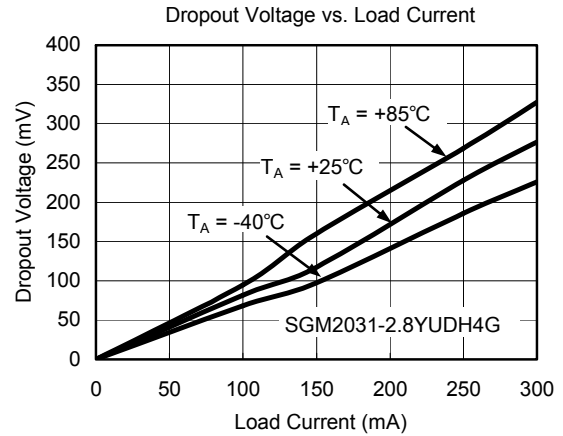
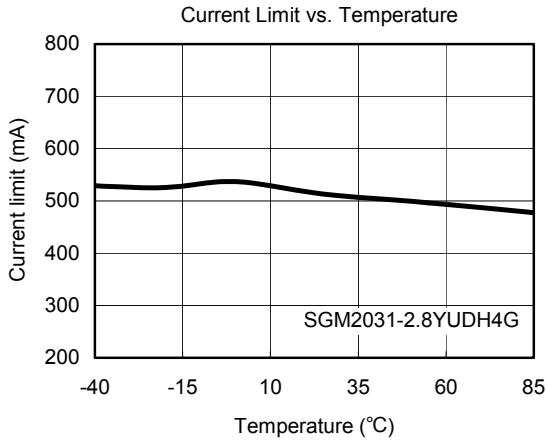

TYPICAL PERFORMANCE CHARACTERISTICS

$V_{IN} = V_{OUT(NOMINAL)} + 0.5V$ or $2.5V$ (whichever is greater), $C_{IN} = 1\mu F$, $C_{OUT} = 1\mu F$, $T_A = +25^\circ C$, unless otherwise noted.

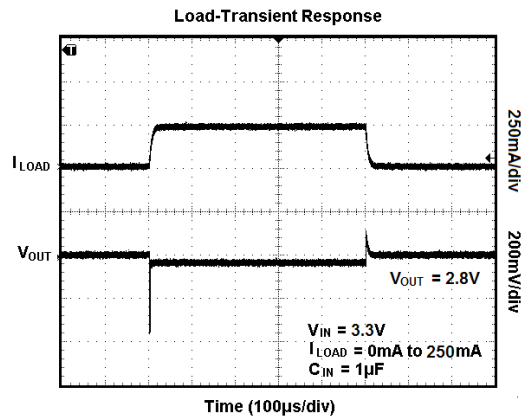
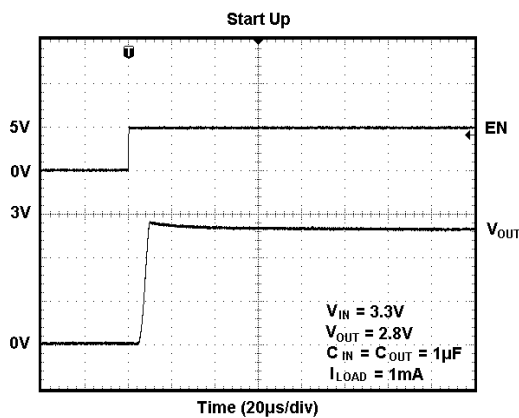
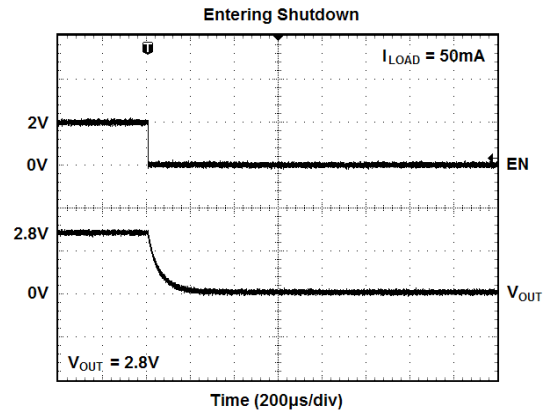
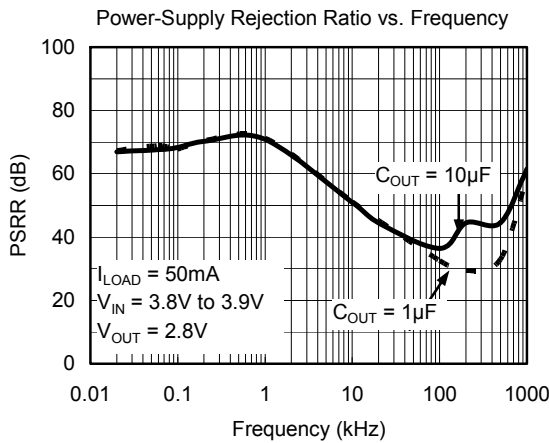
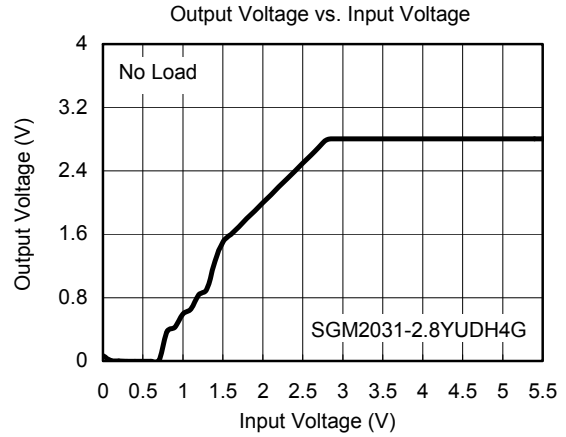
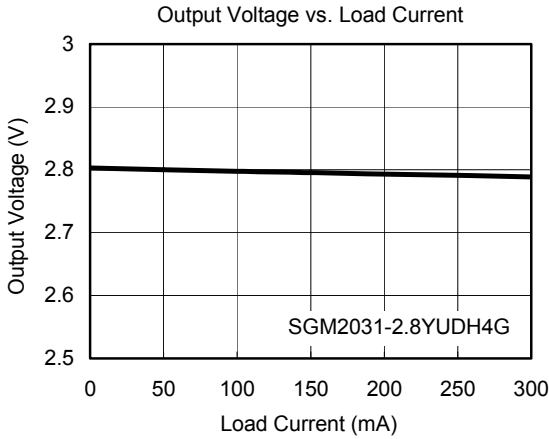

TYPICAL PERFORMANCE CHARACTERISTICS

$V_{IN} = V_{OUT(NOMINAL)} + 0.5V$ or $2.5V$ (whichever is greater), $C_{IN} = 1\mu F$, $C_{OUT} = 1\mu F$, $T_A = +25^\circ C$, unless otherwise noted.

Line-Transient Response

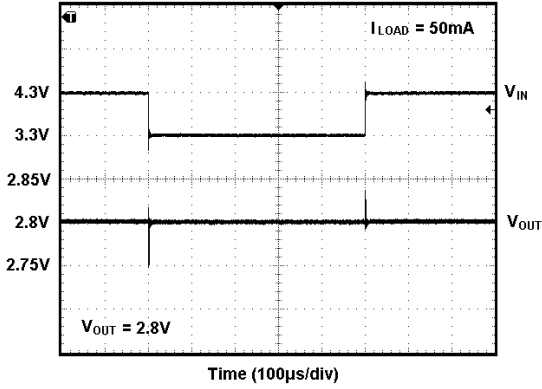

Shutdown Exit Delay

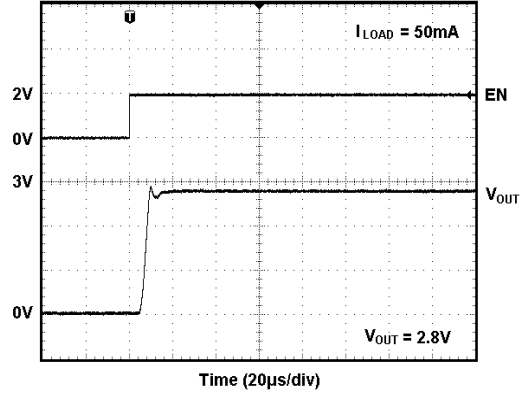

Load-Transient Response Near Dropout

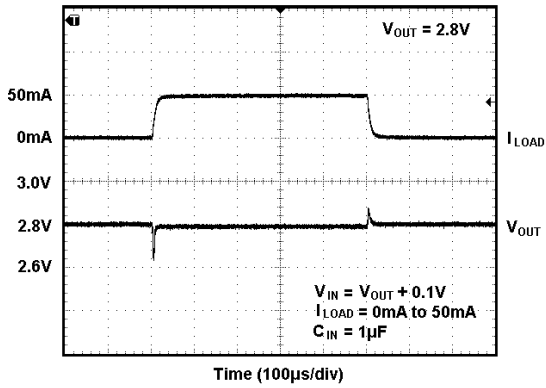

Output Noise 10Hz to 100kHz

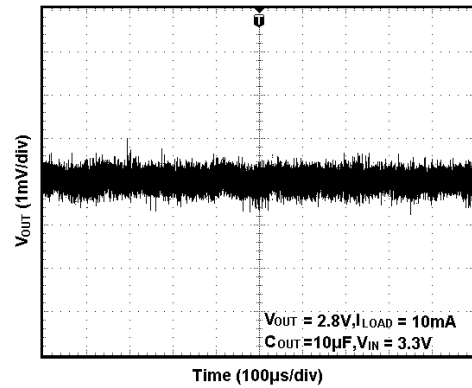

APPLICATION NOTE

When LDO is used in handheld products, attention must be paid to voltage spikes which could damage SGM2031. In such applications, voltage spikes will be generated at charger interface and V_{BUS} pin of USB interface when charger adapters and USB equipments are hot-plugged. Besides this, handheld products will be tested on the production line without battery. Test engineer will apply power from the connector pin which connects with positive pole of the battery. When external power supply is turned on suddenly, the voltage spikes will be generated at the battery connector. The voltage spikes will be very high, and it always exceeds the absolute maximum input voltage (6.0V) of LDO. In order to get robust design, design engineer needs to clear up this voltage spike. Zener diode is a cheap and effective solution to eliminate such voltage spike. For example, BZM55B5V6 is a 5.6V small package Zener diode which can be used to remove voltage spikes in cell phone designs. The schematic is shown below.

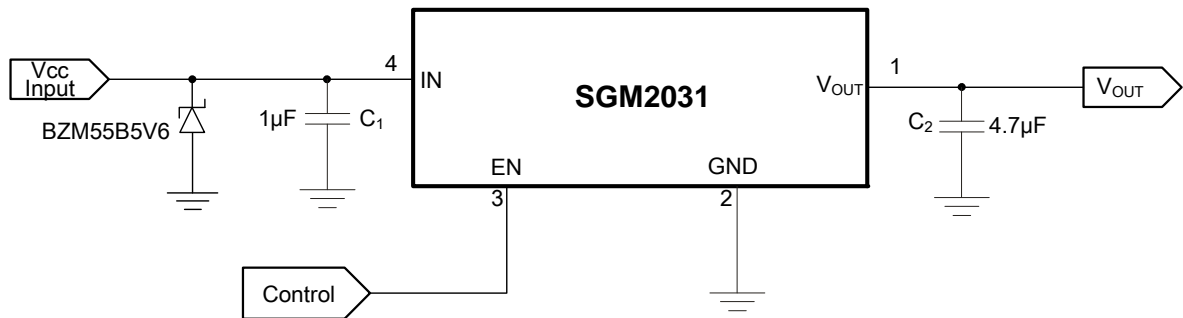

PACKAGE OUTLINE DIMENSIONS

UTDFN-1x1-4L

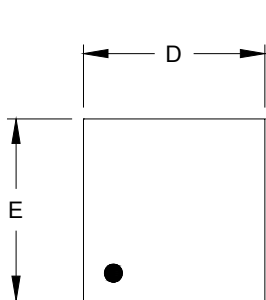

TOP VIEW

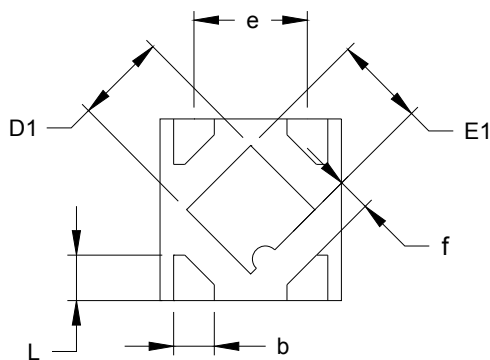

BOTTOM VIEW

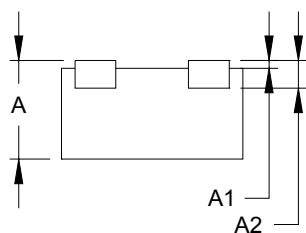

SIDE VIEW

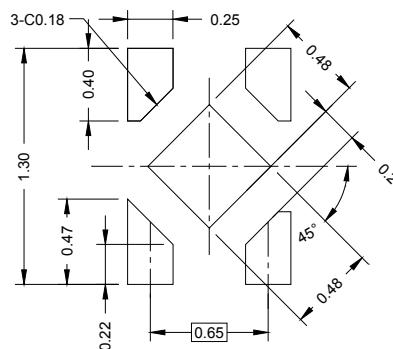

RECOMMENDED LAND PATTERN (Unit: mm)

Symbol	Dimensions In Millimeters		
	MIN	MOD	MAX
A	0.500	0.550	0.600
A1	0.000		0.050
A2	0.152 REF		
D	0.950	1.000	1.050
D1	0.450	0.500	0.550
E	0.950	1.000	1.050
E1	0.450	0.500	0.550
b	0.175	0.225	0.275
e	0.625 BSC		
f	0.195 REF		
L	0.200	0.250	0.300

TAPE AND REEL INFORMATION

REEL DIMENSIONS

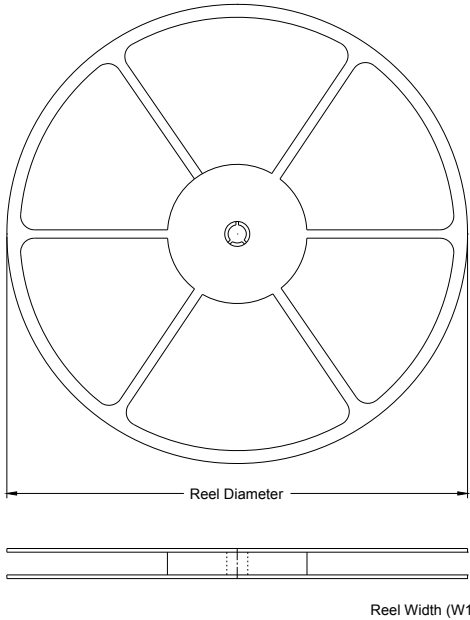

TAPE DIMENSIONS

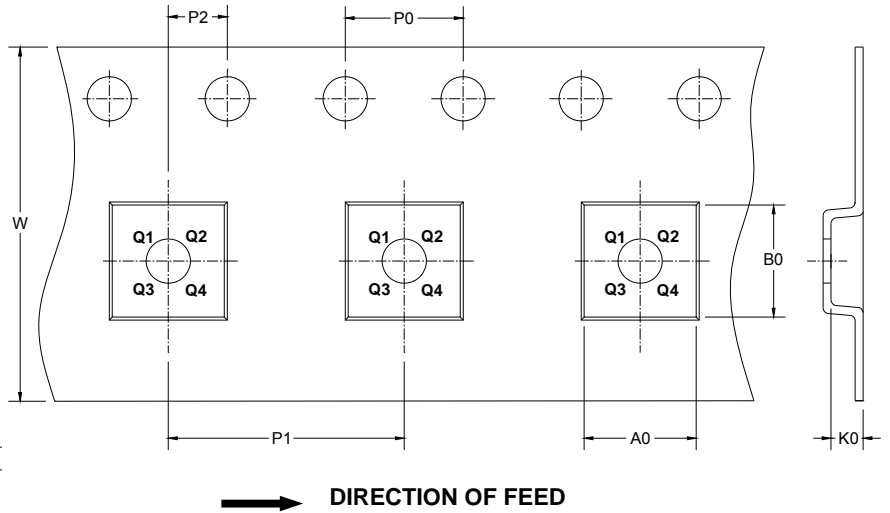

NOTE: The picture is only for reference. Please make the object as the standard.

KEY PARAMETER LIST OF TAPE AND REEL

Package Type	Reel Diameter	Reel Width W1 (mm)	A0 (mm)	B0 (mm)	K0 (mm)	P0 (mm)	P1 (mm)	P2 (mm)	W (mm)	Pin1 Quadrant
UTDFN-1×1-4L	7"	9.0	1.2	1.2	0.6	2.0	4.0	2.0	8.0	Q1

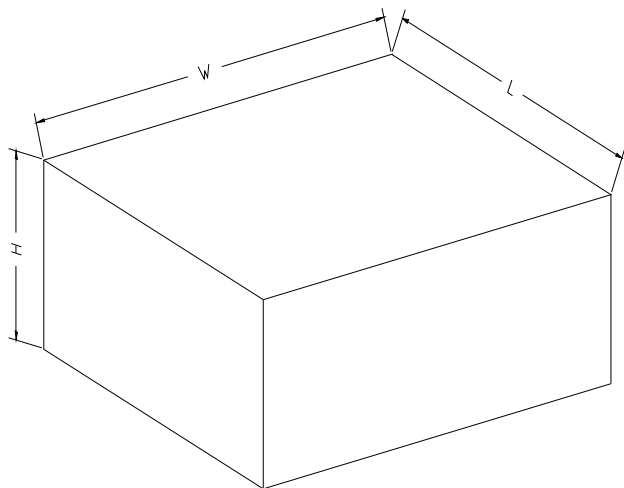
CARTON BOX DIMENSIONS

NOTE: The picture is only for reference. Please make the object as the standard.

KEY PARAMETER LIST OF CARTON BOX

Reel Type	Length (mm)	Width (mm)	Height (mm)	Pizza/Carton
7" (Option)	368	227	224	8
7"	442	410	224	18