

1

2

3

4

5

6

7

A

A

B

B

C

C

D

D

E

E

F

F

G

G

H

H

PIN ASSIGNMENT

P1		P2
1	black	1
2	brown	2
3	red	3
4	orange	4
5	yellow	5
6	green	6
7	blue	7
8	purple	8
9	gray	9
10	white	9
11	pink	10
12	light/green	11
13	red/black	12
14	orange/black	13
15	yellow/black	14
16	green/black	15
17	blue/black	16
18	purple/black	17
19	white/black	18
20	red/white	19
21	orange/white	20
22	green/white	21
23	blue/white	22
24	purple/white	23
25	brown/white	24
	drain	25
SHELL		SHELL

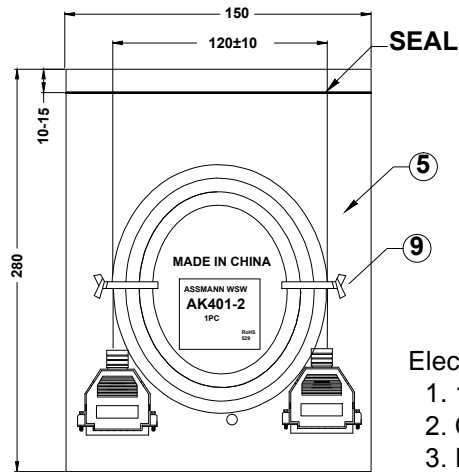
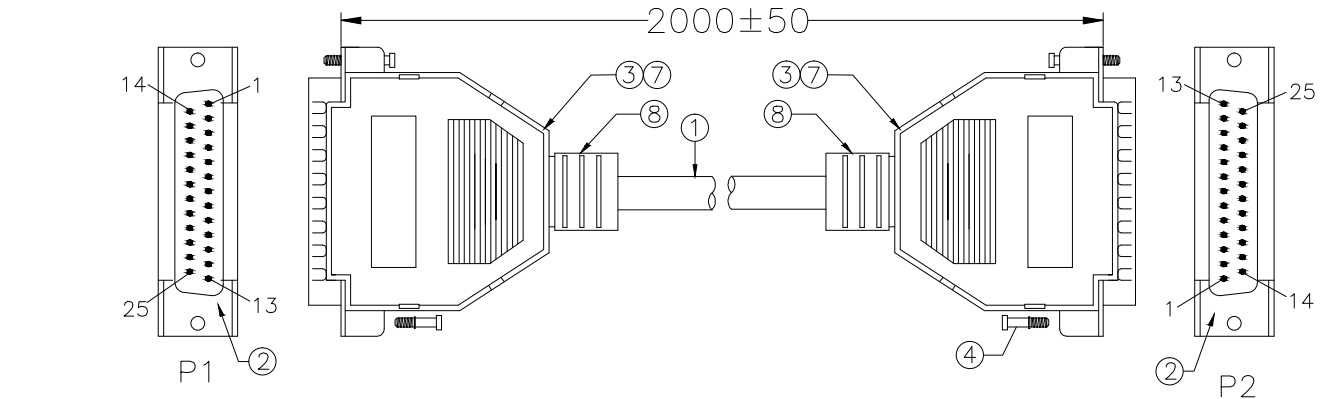

Electrical test:

- 100% short ,open,miswire test
- Conduct resistance: 2Ω max.
- Insulation resistance: 5MΩ min.
- Hi-Pot: 300V DC

No.	NAME	QTY	DESCRIPTION
⑨	TIE	2	WHITE L=100MM
⑧	S/R	5.5g	BEIGE 45P PVC
⑦	TUBE	2	HEAT SHRINK TUBE BLACK OD 1.5MM
⑥	PE BAG	1/10	CLEAR SIZE: 360*380*0.05mm, PRINT BLACK"MADE IN CHINA"+*10PC"
⑤	PE BAG	1	CLEAR SIZE: 150*280*0.05mm, PRINT BLACK"MADE IN CHINA"+*1PC"
④	SCREW	4	SCREW:#4-40UNC L12.5mm,nickel plated
③	DKN	2	DB25P DKN W/O NUT BEIGE
②	CONN	2	DB 25PIN MALE PIN G/F SHELL-NIKEL SOLDER TYPE INSULATION COLOR BLUE
①	CABLE	1	NOUL 28AWG*25C+D+AL/MY,BEIGE,OD6.5mm

RoHS compliant

Unit: mm

Scale	FREE					Date	Name	Customer-No.
TOLERANCE						Drawn	17.11.2014	Joanna
						Approved	17.11.2014	Joanna
DIM	TOL							
		①	Drawn	17.11.2014	Joanna			
Angle	TOL	Id.	Modification	Date	Name			

ASSMANN
WSW components

Drawing-No.	rev
ASS 7239 CA	rev00
Replace	Sheet

1

2

3

4

5

6

7