



# MH201

High Dynamic Range Cellular Band MMIC Mixer

The Communications Edge™

Advanced Product Information

## Product Features

- +30 dBm IIP3
- RF 800 – 915 MHz
- LO 550 – 715 MHz
- IF 200 – 250 MHz
- +17 dBm Drive Level
- Low Cost SOIC-8 Package
- No External Bias Required

## Product Description

The MH201 is a passive GaAs MESFET mixer that provides high dynamic range performance in a low cost SOIC-8 package. WJ's MH201 uses patented techniques to realize +30 dBm Input IP3 at an LO drive level of +17 dBm when used in a simple application circuit as an upconverting configuration. This single monolithic integrated circuit does not require any external baluns or bias elements.

Typical applications include frequency up/down conversion, modulation and demodulation for receivers and transmitters used in 2.5G and 3G systems using the cellular frequency bands.

## Functional Diagram

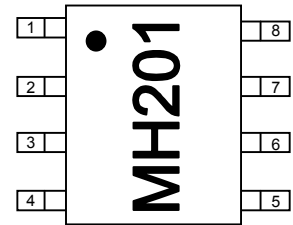

Function	Pin No.
LO	2
IF & RF*	5
GND	1,3,4,6,8

\* 4 external components (inductors & capacitors) are required to diplex the signal

## Specifications

Parameters <sup>1</sup>	Units	Minimum	Typical	Maximum	Comments
Frequency Range:					
RF	MHz	800		915	
LO	MHz	550		715	
IF	MHz	200		250	
SSB Conversion Loss	dB		9.5	10	
Noise Figure	dB		10		
Input IP3 <sup>2</sup>	dBm		+30		
Input P1dB	dBm		TBD		
Isolation:					
L-R	dB		30		
L-I	dB		55		
R-I	dB		TBD		
Return Loss:	dB				
LO Port			-5		
LO Drive Level	dBm		+17		

1. Data was taken using an application board shown on the following page, with a low side LO at +17 dBm in an upconverting application at 25°C.  
 2. Input IP3 was measured with two tones with an input power of -5 dBm / tone separated by 1 MHz.

## Absolute Maximum Rating<sup>3</sup>

Parameters	Rating
Operating Case Temperature	-40° to +85 °C
Storage Temperature	-65° to +100 °C
Maximum Input LO Power <sup>4</sup>	+21 dBm

3. Operation of this device above any of these parameters may cause permanent damage.  
 4. Total sum of LO port and RF port power should not to exceed +23 dBm.

## Application Circuit

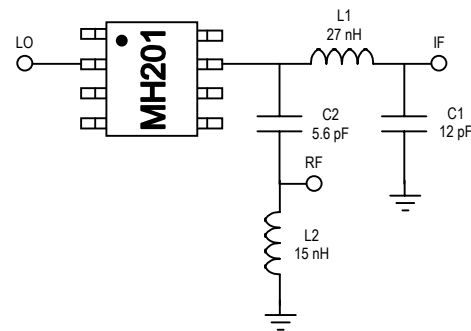

All components are of size 0402



# MH201

High Dynamic Range Cellular Band MMIC Mixer

## OUTLINE DRAWING

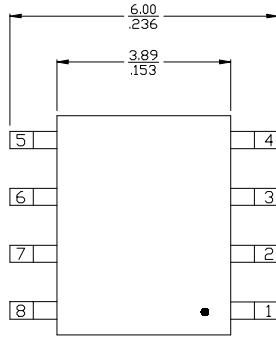

TOP VIEW

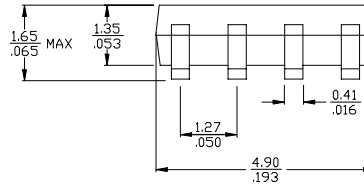
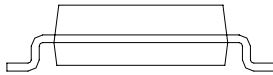

mm  
inch

## LAND PATTERN

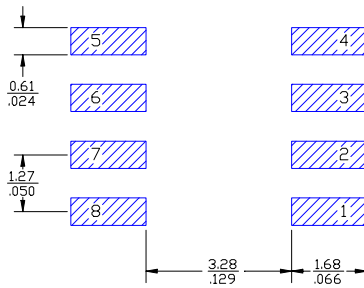

FUNCTION	PIN NO.
GROUND	1
LD	2
GROUND	3-6
RF & IF	7
GROUND	8

## MOUNTING CONFIGURATION

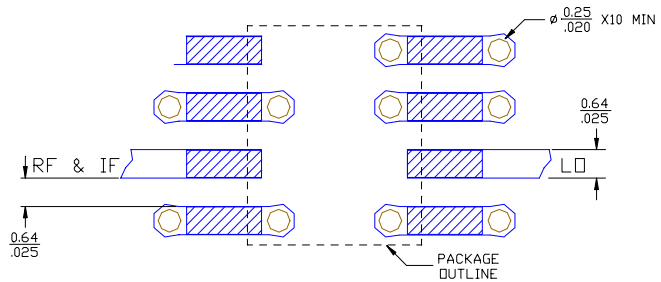

- Notes:
1. Ground vias are critical for thermal and RF grounding considerations.
  2. A minimum of 10 ground vias are required for 14 mil and 28 mil FR4 board.
  3. If your PCB design rules allow, ground vias should be placed under the land pattern for better RF and thermal performance. Otherwise ground vias should be placed as close to land pattern as possible.
  4. Trace width depends on PC board.

This document contains information on a new product. Specifications and information are subject to change without notice.



Caution! ESD sensitive device.