

CST-1030

Description:

Triad current sense transformers are used to detect the current passing through a conductor. These transformers are very reliable and operate efficiently at 50/60 Hz.

Electrical Specifications (@25C)

IP Amps	Turns Ratio	Terminating Resistor		DCR (Ω) Nominal	Volts/Amp@ rated IP for various loads (Ω)				Net Weight Grams
		Ohms	Watts		100	500	2K	5K	
30	1000:1	100	.09	46	.0977	.4160	.6710	.8750	30

Dimensions:

A	B	C	D	E	F
30.20	30.20	14.30	20.32	10.16	11.40

Units: In mm

Schematic:

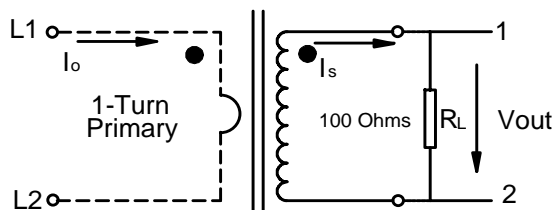

Technical Notes:

1. Pin3 for mechanical support only.
2. Pin diameter is 0.8 ± 0.1 mm.
3. Pin length is 5 ± 1 mm.

RoHS Compliance: As of manufacturing date February 2005, all standard products meet the requirements of 2011/65/EU, known as the RoHS initiative.

* Upon printing, this document is considered "uncontrolled". Please contact Triad Magnetics' website for the most current version.

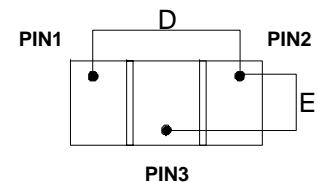
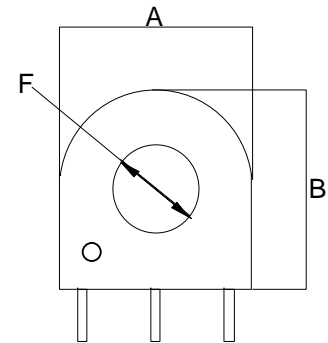

BOTTOM VIEW