

CMPA2560025D

25 W, 2.5 - 6.0 GHz, GaN MMIC, Power Amplifier

Cree's CMP2560025D is a gallium nitride (GaN) High Electron Mobility Transistor (HEMT) based monolithic microwave integrated circuit (MMIC). GaN has superior properties compared to silicon or gallium arsenide, including higher breakdown voltage, higher saturated electron drift velocity and higher thermal conductivity. GaN HEMTs also offer greater power density and wider bandwidths compared to Si and GaAs transistors. This MMIC contains a two-stage reactively matched amplifier design approach enabling very wide bandwidths to be achieved.

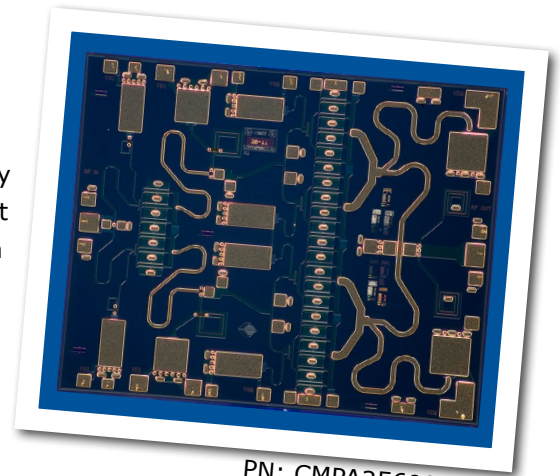

PN: CMPA2560025D

Typical Performance Over 2.5-6.0 GHz ($T_c = 25^\circ\text{C}$)

Parameter	2.5 GHz	4.0 GHz	6.0 GHz	Units
Gain	27.5	24.3	23.1	dB
Saturated Output Power, P_{SAT}^1	35.8	37.5	25.6	W
Power Gain @ $P_{OUT} = 43\text{ dBm}$	23.1	20.9	16.3	dB
PAE @ $P_{OUT} = 43\text{ dBm}$	31.5	32.8	30.7	%

Note¹: P_{SAT} is defined as the RF output power where the device starts to draw positive gate current in the range of 7-13 mA.

Features

- 24 dB Small Signal Gain
- 25 W Typical P_{SAT}
- Operation up to 28 V
- High Breakdown Voltage
- High Temperature Operation
- Size 0.180 x 0.145 x 0.004 inches

Applications

- Ultra Broadband Amplifiers
- Fiber Drivers
- Test Instrumentation
- EMC Amplifier Drivers



Absolute Maximum Ratings (not simultaneous) at 25 °C

Parameter	Symbol	Rating	Units
Drain-source Voltage	V_{DSS}	84	VDC
Gate-source Voltage	V_{GS}	-10, +2	VDC
Storage Temperature	T_{STG}	-65, +150	°C
Operating Junction Temperature	T_J	225	°C
Thermal Resistance, Junction to Case (packaged) ¹	$R_{\theta JC}$	2.5	°C/W
Mounting Temperature (30 seconds)	T_S	320	°C

Note¹ Eutectic die attach using 80/20 AuSn solder mounted to a 40 mil thick CuW carrier.

Electrical Characteristics (Frequency = 2.5 GHz to 6.0 GHz unless otherwise stated; $T_c = 25\text{ °C}$)

Characteristics	Symbol	Min.	Typ.	Max.	Units	Conditions
DC Characteristics						
Gate Threshold Voltage	$V_{(GS)TH}$	-3.8	-3.0	-2.3	V	$V_{DS} = 10\text{ V}, I_D = 20\text{ mA}$
Gate Quiescent Voltage	$V_{(GS)Q}$	-	-2.7	-	VDC	$V_{DD} = 26\text{ V}, I_{DQ} = 1200\text{ mA}$
Saturated Drain Current	I_{DS}	8.0	9.7	-	A	$V_{DS} = 6.0\text{ V}, V_{GS} = 2.0\text{ V}$
Drain-Source Breakdown Voltage	V_{BD}	84	100	-	V	$V_{GS} = -8\text{ V}, I_D = 20\text{ mA}$
On Resistance	R_{ON}	-	0.35	-	Ω	$V_{DS} = 0.1\text{ V}$
Gate Forward Voltage	V_{G-ON}	-	1.9	-	V	$I_{GS} = 3.6\text{ mA}$
RF Characteristics						
Small Signal Gain	S21	21	25	-	dB	$V_{DD} = 26\text{ V}, I_{DQ} = 1200\text{ mA}$
Power Output at 2.5 GHz	P_{OUT1}	30	-	-	W	$V_{DD} = 26\text{ V}, I_{DQ} = 1200\text{ mA}, P_{IN} \leq 26\text{ dBm}$
Power Output at 3.0 GHz	P_{OUT2}	20	25	-	W	$V_{DD} = 26\text{ V}, I_{DQ} = 1200\text{ mA}, P_{IN} \leq 26\text{ dBm}$
Power Output at 4.0 GHz	P_{OUT3}	20	30	-	W	$V_{DD} = 26\text{ V}, I_{DQ} = 1200\text{ mA}, P_{IN} \leq 26\text{ dBm}$
Power Added Efficiency	PAE	-	35	-	%	$V_{DD} = 26\text{ V}, I_{DQ} = 1200\text{ mA}$
Power Gain	G_P	-	20	-	dB	$V_{DD} = 26\text{ V}, I_{DQ} = 1200\text{ mA}$
Input Return Loss	S11	-	6	-	dB	$V_{DD} = 26\text{ V}, I_{DQ} = 1200\text{ mA}$
Output Return Loss	S22	-	5	-	dB	$V_{DD} = 26\text{ V}, I_{DQ} = 1200\text{ mA}$
Output Mismatch Stress	VSWR	-	-	5:1	Ψ	No damage at all phase angles, $V_{DD} = 26\text{ V}, I_{DQ} = 1200\text{ mA}, P_{OUT} = 25\text{ W CW}$

Die Dimensions (units in microns)

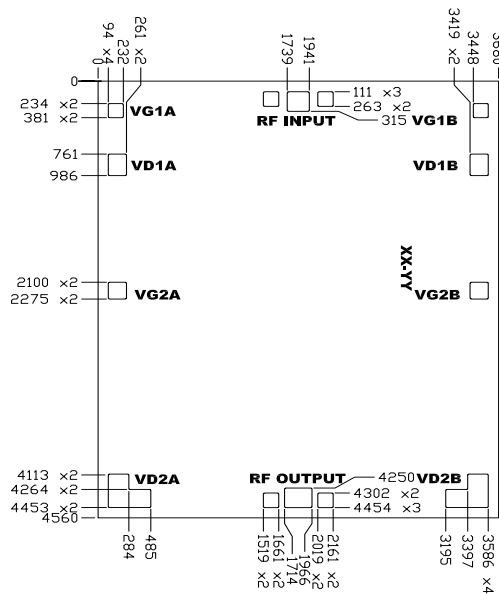

Overall die size 3680 x 4560 (+/-50) microns, die thickness 100 (+/-10) microns.
All Gate and Drain pads must be wire bonded for electrical connection.

Pad Number	Function	Description	Pad Size (microns)	Note
1	RF-IN	RF-Input pad. Matched to 50 ohm. Requires gate control from an external bias -T from -1.5 V to -2.5 V and external blocking capacitor.	202 X 204	3
2	VG1_A	Gate control for stage 1. V_G -1.5 - 2.5 V.	138 x 147	1,2
3	VG1_B	Gate control for stage 1. V_G -1.5 - 2.5 V.	138 x 147	1,2
4	VD1_A	Drain supply for stage 1. V_D = 26 V.	167 x 225	1
5	VD1_B	Drain supply for stage 1. V_D = 26 V.	167 x 225	1
6	VG2_A	Gate control for stage 2A. V_G -1.5 - 2.5 V.	167 x 175	1
7	VG2_B	Gate control for stage 2B. V_G -1.5 - 2.5 V.	167 x 175	1
8	VD2_A	Drain supply for stage 2A. V_D = 26 V.	A	1
9	VD2_B	Drain supply for stage 2B. V_D = 26 V.	A	1
10	RF-Out	This pad is DC blocked internally. The DC impedance \sim 0 ohm due output matching circuit. Requires external matching circuit for optimal performance for $f > 4.0$ GHz.	252 x 204	3

Notes:

- Attach bypass capacitor to port 2-9 per application circuit.
- VG1_A and VG1_B is connected internally so it would be enough to connect either one for proper operation.
- The RF Input and Output pad have a ground-signal-ground with a pitch of 10 mil (250 μ m).

Die Assembly Notes:

- Recommended solder is AuSn (80/20) solder. Refer to Cree's website for the Eutectic Die Bond Procedure application note at http://www.cree.com/products/wireless_appnotes.asp
- Vacuum collet is the preferred method of pick-up.
- The backside of the die is the Source (ground) contact.
- Die back side gold plating is 5 microns thick minimum.
- Thermosonic ball or wedge bonding are the preferred connection methods.
- Gold wire must be used for connections.
- Use the die label (XX-YY) for correct orientation.

Block Diagram Showing Additional Capacitors & Output Matching Section for Operation Over 2.5 to 6.0 GHz

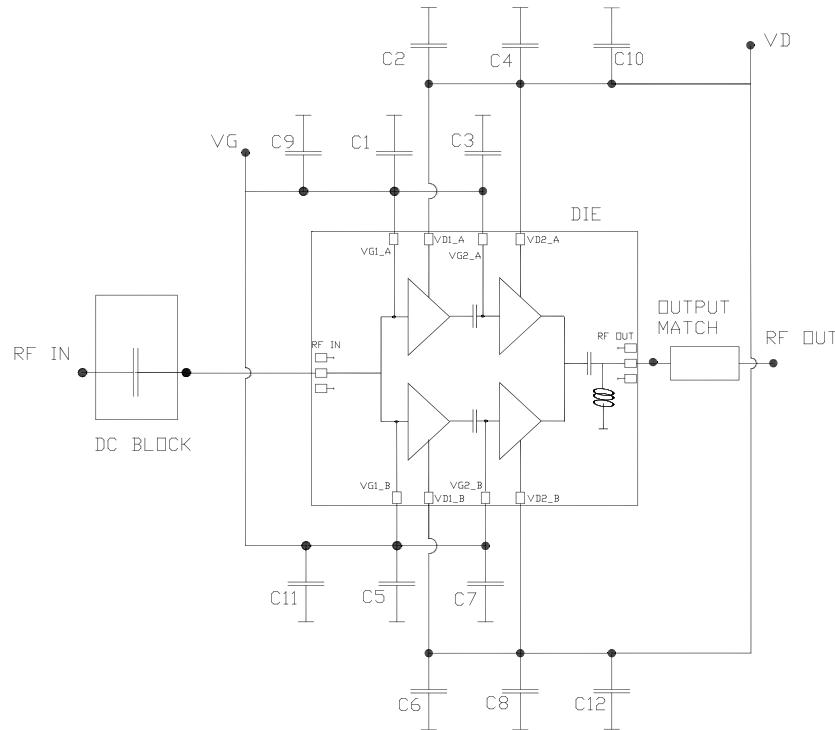

Designator	Description	Quantity
C1,C2,C3,C4,C5,C6,C7,C8	CAP, 120pF, +/-10%, SINGLE LAYER, 0.030", Er 3300, 100V, Ni/Au TERMINATION	8
C9,C10,C11,C12	CAP, 680pF, +/-10%, SINGLE LAYER, 0.070", Er 3300, 100V, Ni/Au TERMINATION	4

Notes:

- ¹ An additional microstripline of 31 ohm impedance and electrical length of 72° at 6.0 GHz at the output of the MMIC is required to optimize overall performance in the 2.5 to 6.0 GHz frequency band.
- ² The input, output and decoupling capacitors should be attached as close as possible to the die- typical distance is 5 to 10 mils with a maximum of 15 mils.
- ³ The MMIC die and capacitors should be connected with 2 mil gold bond wires.



Typical Performance of the CMPA2560025D as Measured in CMPA2560025F-TB

Small Signal Gain vs Frequency

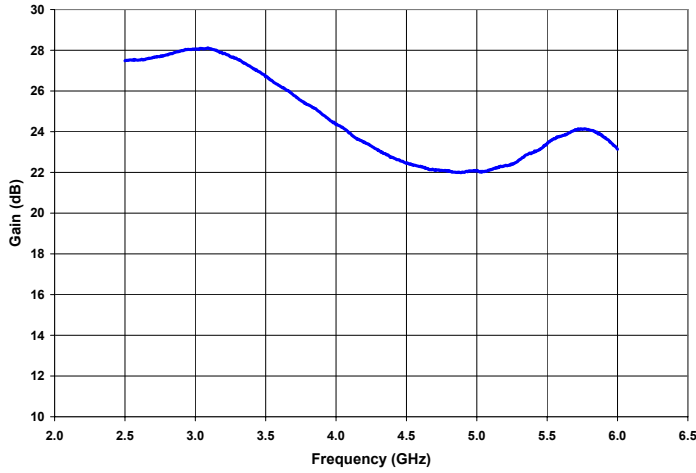

Input & Output Return Losses vs Frequency

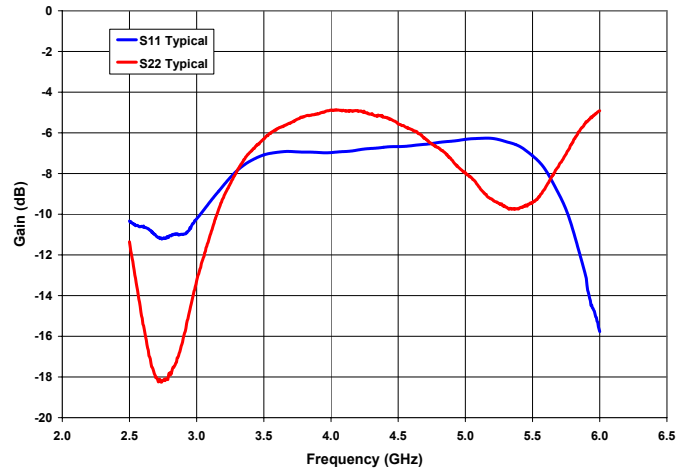

Power Gain vs Frequency

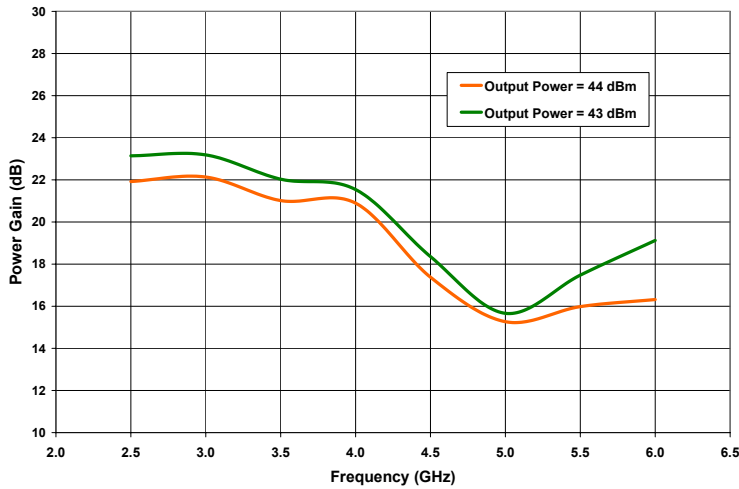

Gain vs Output Power as a Function of Frequency

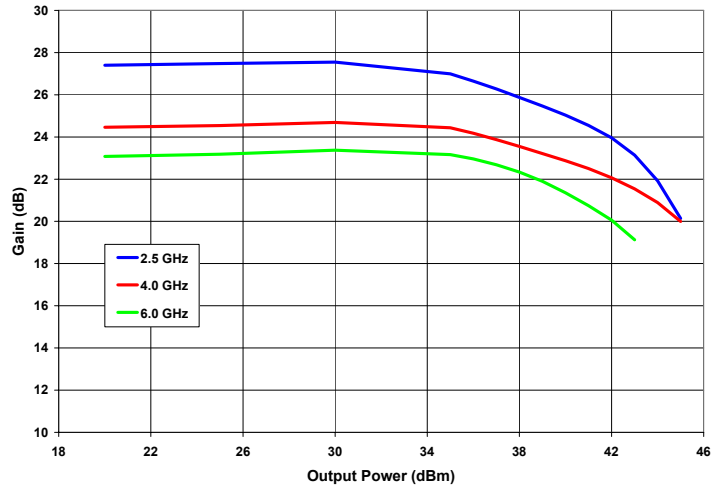



Typical Performance of the CMPA2560025D as Measured in CMPA2560025F-TB

Saturated Output Power Performance (P_{SAT}) vs Frequency

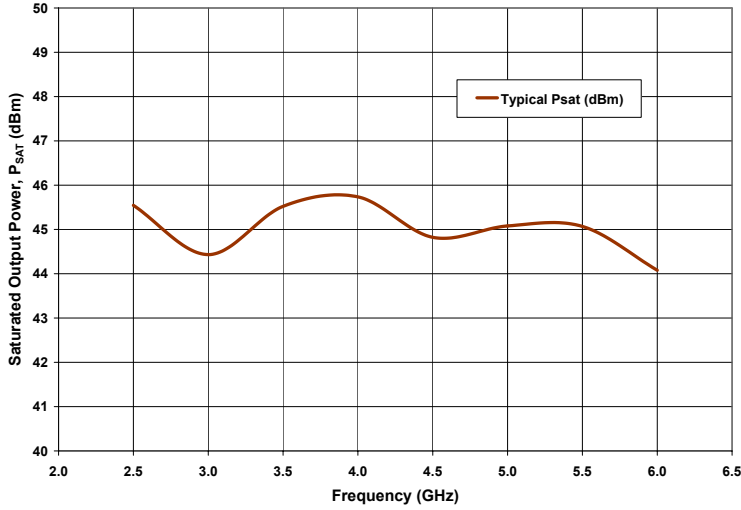

Frequency (GHz)	P_{SAT} (dBm)	P_{SAT} (W)
2.5	45.54	35.8
3.0	44.43	27.7
3.5	45.52	35.7
4.0	45.74	37.5
4.5	44.82	30.4
5.0	45.08	32.2
5.5	45.07	32.1
6.0	44.08	25.6

Note: P_{SAT} is defined as the RF output power where the device starts to draw positive gate current in the range of 7-13 mA.

Power Added Efficiency vs Output Power as a Function of Frequency

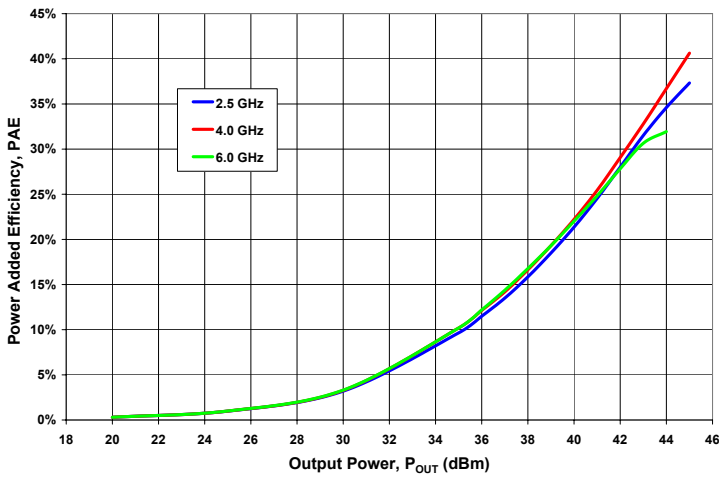

PAE at 43 dBm and 44 dBm Output Power vs Frequency

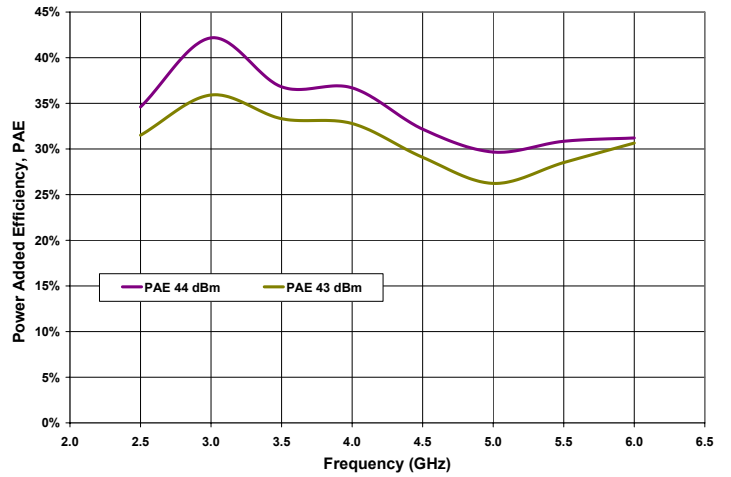



Typical Performance of the CMPA2560025D as Measured in CMPA2560025F-TB

2ND Harmonic vs Output Power as a Function of Frequency

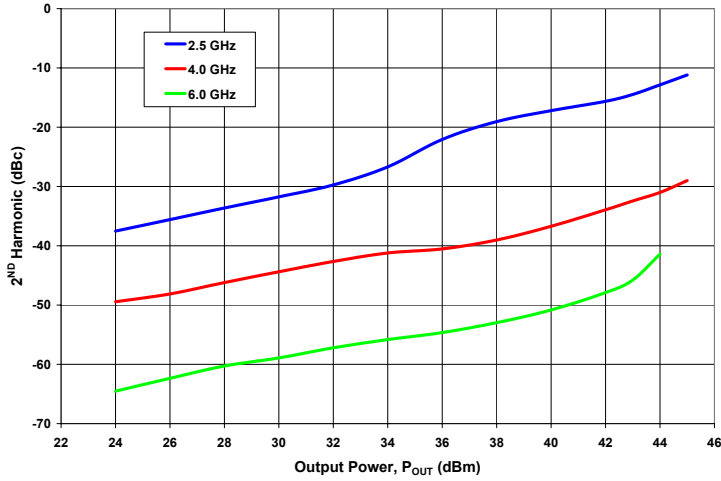

IM3 vs Total Average Power as a Function of Frequency

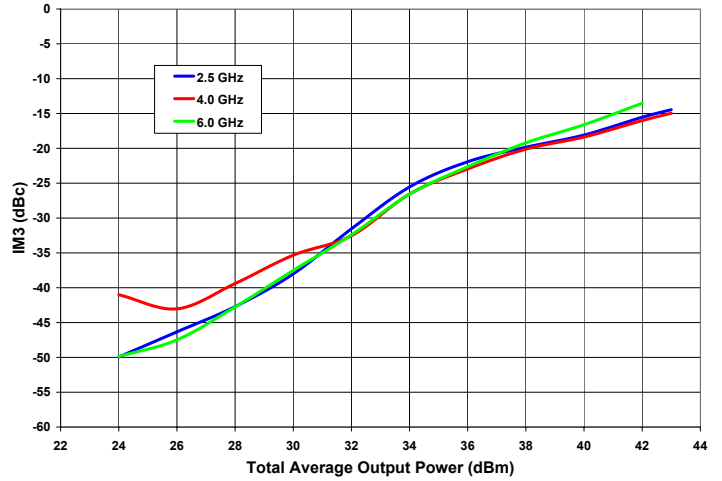

Gain at P_{OUT} of 40 dBm at 25°C & 75°C vs Frequency

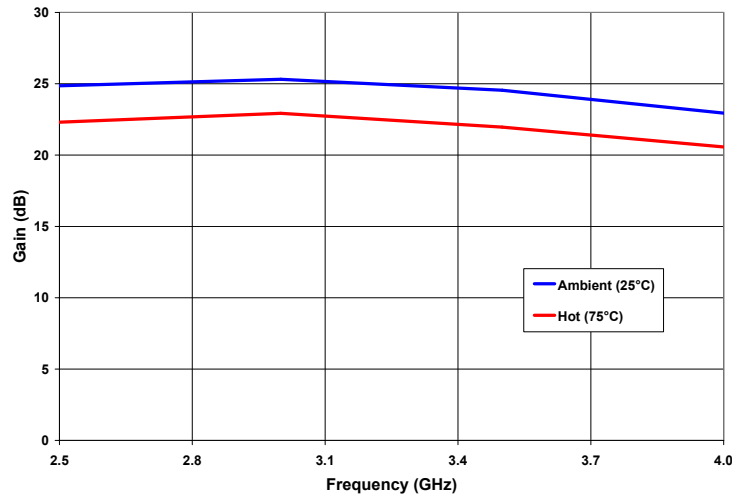

Note: The temperature coefficient is -0.05 dB/°C

Source and Load Impedances

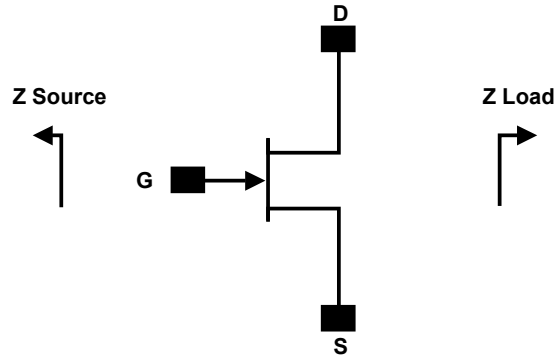

Frequency (MHz)	Z Source	Z Load
2500	50 + j0	36.2 - j15.4
3000	50 + j0	32.7 - j15.4
3500	50 + j0	29.6 - j14.7
4000	50 + j0	27.0 - j13.8
4500	50 + j0	24.8 - j12.1
5000	50 + j0	23.0 - j10.4
5500	50 + j0	21.6 - j8.6
6000	50 + j0	20.6 - j6.7

Note 1. $V_{DD} = 26V$, $I_{DQ} = 1200mA$ in the 780019 package.

Note 2. Optimized for P_{SAT}

Note 3: The quoted impedances are those presented to the die by the CMPA2560025F-TB demonstration amplifier, fully de-embedded to the die bond pad reference plane.

Electrostatic Discharge (ESD) Classifications

Parameter	Symbol	Class	Test Methodology
Human Body Model	HBM	1A (> 250 V)	JEDEC JESD22 A114-D
Charge Device Model	CDM	II (200 < 500 V)	JEDEC JESD22 C101-C



Disclaimer

Specifications are subject to change without notice. Cree, Inc. believes the information contained within this data sheet to be accurate and reliable. However, no responsibility is assumed by Cree for its use or for any infringement of patents or other rights of third parties which may result from its use. No license is granted by implication or otherwise under any patent or patent rights of Cree. Cree makes no warranty, representation or guarantee regarding the suitability of its products for any particular purpose. "Typical" parameters are the average values expected by Cree in large quantities and are provided for information purposes only. These values can and do vary in different applications, and actual performance can vary over time. All operating parameters should be validated by customer's technical experts for each application. Cree products are not designed, intended, or authorized for use as components in applications intended for surgical implant into the body or to support or sustain life, in applications in which the failure of the Cree product could result in personal injury or death, or in applications for the planning, construction, maintenance or direct operation of a nuclear facility. CREE and the CREE logo are registered trademarks of Cree, Inc.

For more information, please contact:

Cree, Inc.
4600 Silicon Drive
Durham, North Carolina, USA 27703
www.cree.com/wireless

Sarah Miller
Marketing & Export
Cree, RF Components
1.919.407.5302

Ryan Baker
Marketing
Cree, RF Components
1.919.407.7816

Tom Dekker
Sales Director
Cree, RF Components
1.919.407.5639