



L9337 series

High power LED for optical switches

The L9337 series is an infrared LED developed for optical switches. Because a high-power LED chip is mounted, the L9337 series provides higher radiant output power than previous devices, moreover it is available at a low cost due to the improved manufacturing process. The L9337-01/-02 use a high reliability package making them suitable for automobile applications.

Features

- High radiant output power
- High reliability
- Low price

Applications

- Optical switches
- Automobiles

Absolute maximum ratings (Ta=25 °C, unless otherwise noted)

Parameter	Symbol	Condition	Value	Unit
Reverse voltage	V _R		5	V
Forward current	I _F		80	mA
Forward current decrease rate	-	T _a > 25 °C	1.1	mA/°C
Pulse forward current	I _{FP}	Pulse width=10 μs Duty ratio=1%	1.0	A
Pulse forward current decrease rate	-	T _a > 25 °C	13	mA/°C
Power dissipation	P		150	mW
Operating temperature	T _{opr}		-30 to +85	°C
Storage temperature	T _{stg}		-40 to +100*1	°C

*1: The L9337 is guaranteed to resist temperature cycle test of up to 5 cycles.

Note: Exceeding the absolute maximum ratings even momentarily may cause a drop in product quality. Always be sure to use the product within the absolute maximum ratings.

Electrical and optical characteristics (Ta=25 °C)

Parameter	Symbol	Condition	L9337			L9337-01			L9337-02			Unit
			Min.	Typ.	Max.	Min.	Typ.	Max.	Min.	Typ.	Max.	
Peak emission wavelength	λ _p	I _F =50 mA	840	870	900	840	870	900	840	870	900	nm
Spectral half width	Δλ	I _F =50 mA	-	45	-	-	45	-	-	45	-	nm
Forward voltage	V _F	I _F =50 mA	-	1.42	1.5	-	1.42	1.5	-	1.42	1.5	V
Pulse forward voltage	V _{FP}	I _F =1 A	-	2.7	3.4	-	2.7	3.4	-	2.7	3.4	V
Reverse current	I _R	V _R =5 V	-	-	5	-	-	5	-	-	5	μA
Radiant flux	φ _e	I _F =50 mA	18	23	-	10	13	-	7.5	10	-	mW
Cut-off frequency*2	f _c	I _F =50 mA ± 4 mAp-p	25	40	-	25	40	-	25	40	-	MHz

*2: Frequency at which the optical output drops by -3 dB from that at 100 kHz.

Emission spectrum

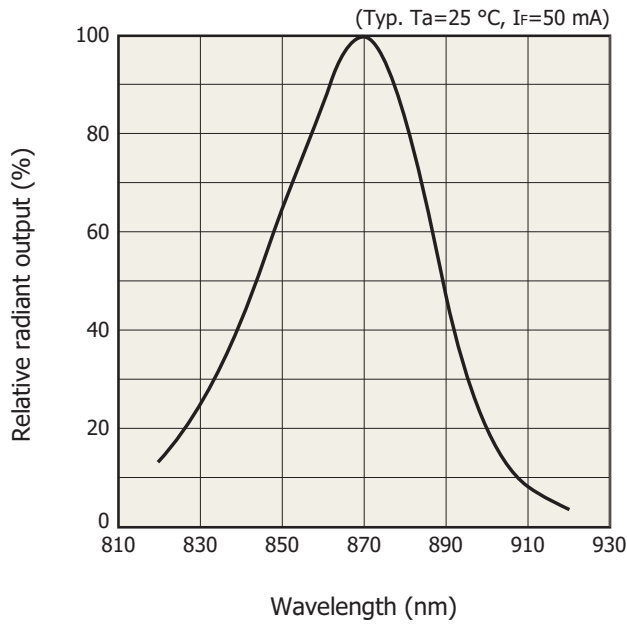

KLEDB0249EA

Radiant flux vs. pulse forward current

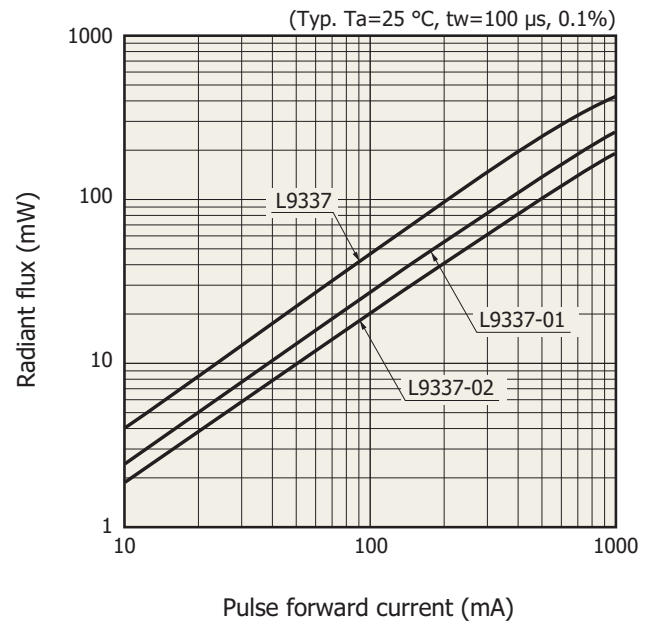

KLEDB0250EC

Pulse forward current vs. pulse forward voltage

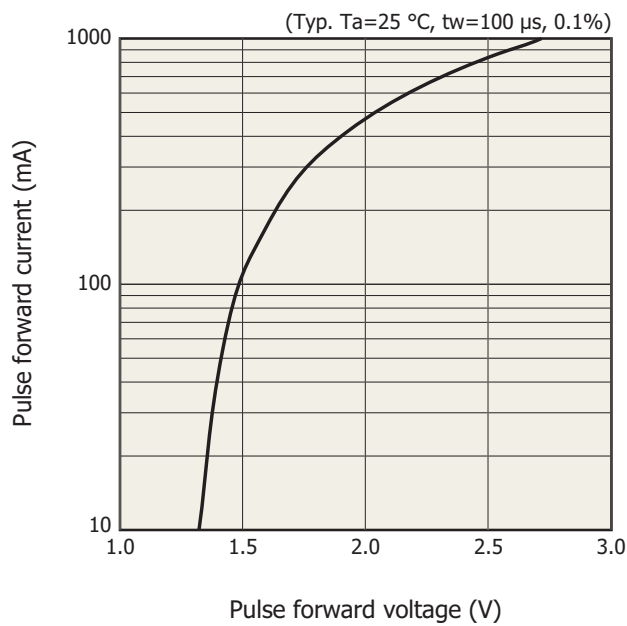

KLEDB0251EC

Directivity

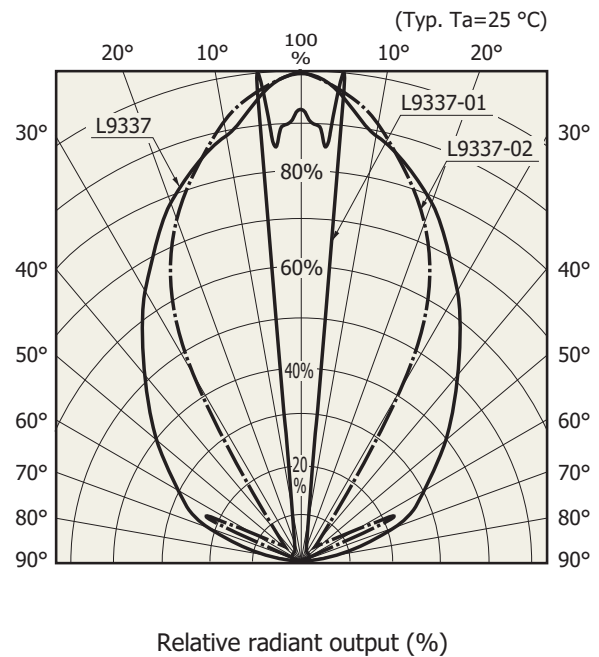

KLEDB0252EB

❑ Radiant output vs. ambient temperature

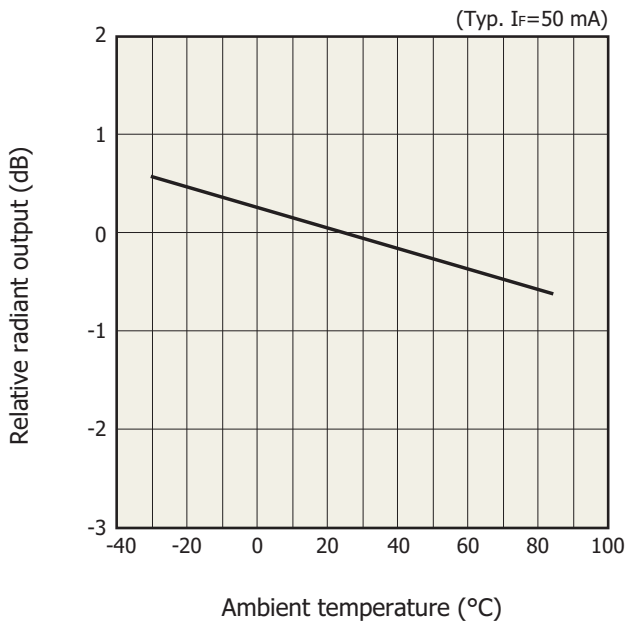

KLED80253EA

❑ Allowable forward current vs. ambient temperature

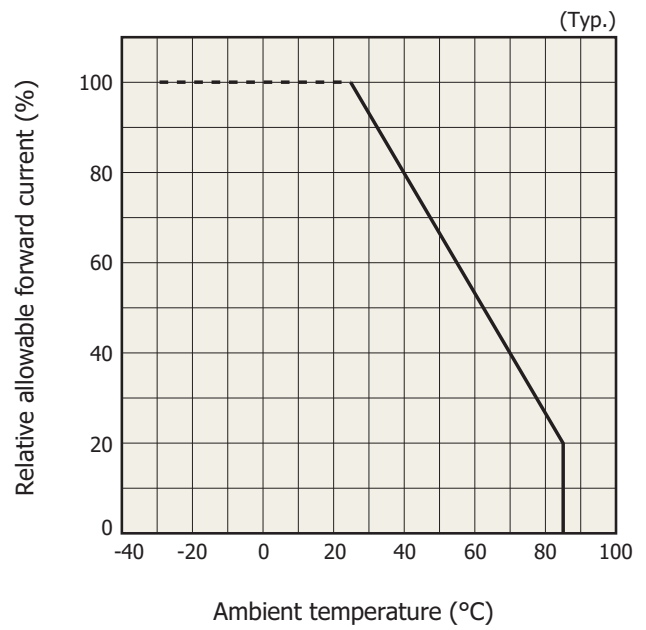

KLED80254EA

❑ Allowable forward current vs. duty ratio

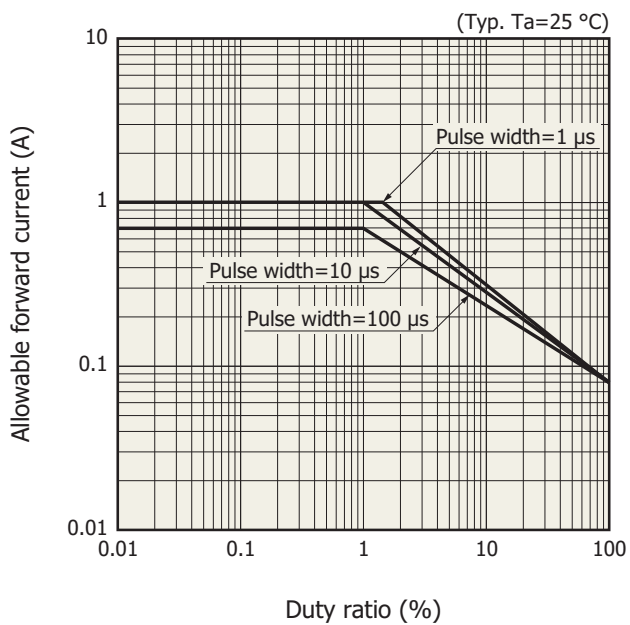

KLED80038EA

Dimensional outlines (unit: mm)

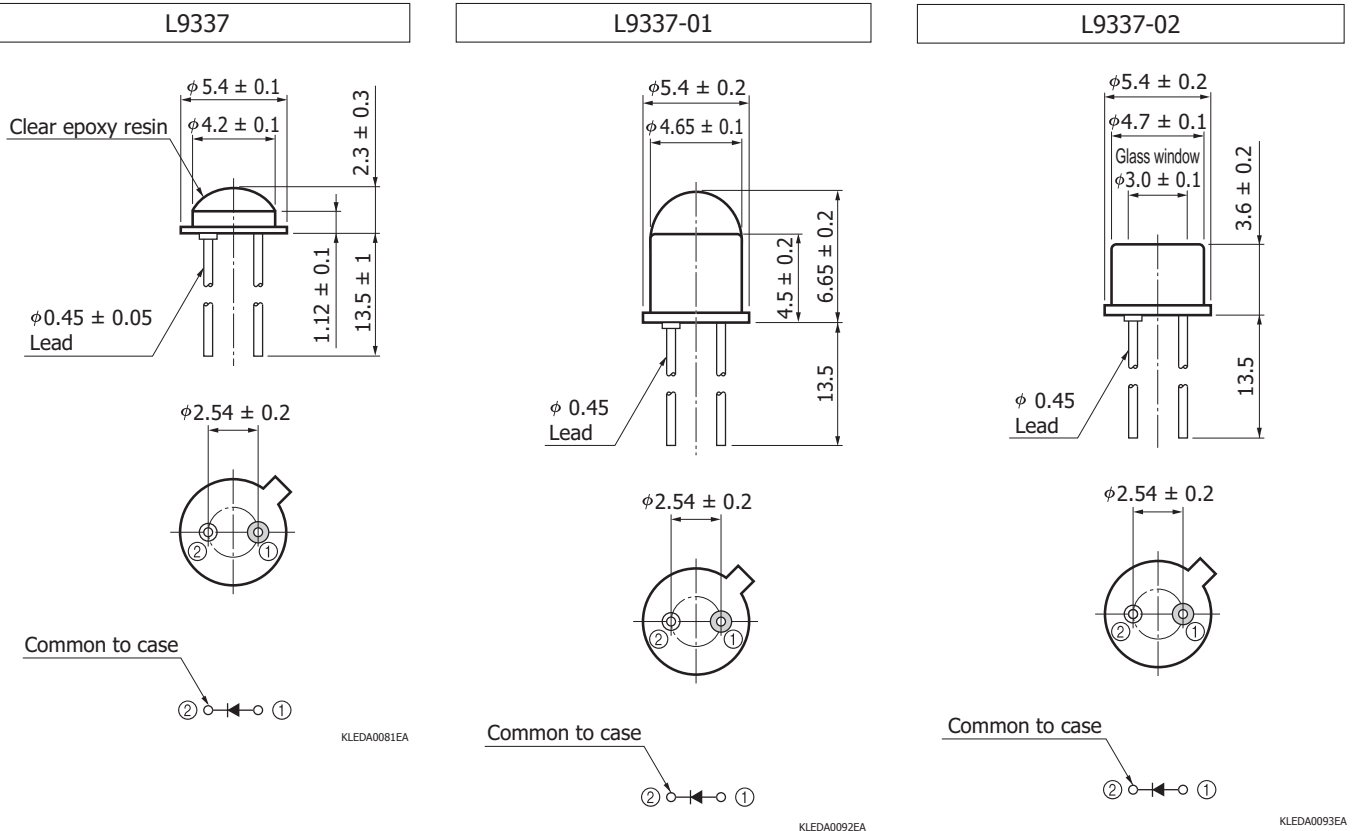

Related information

http://www.hamamatsu.com/sp/ssd/doc_en.html

Precautions

- Notice
- Metal, ceramic, plastic package products / Precautions

Technical information

- LED / Technical information

Information described in this material is current as of September, 2013.

Product specifications are subject to change without prior notice due to improvements or other reasons. This document has been carefully prepared and the information contained is believed to be accurate. In rare cases, however, there may be inaccuracies such as text errors. Before using these products, always contact us for the delivery specification sheet to check the latest specifications.

The product warranty is valid for one year after delivery and is limited to product repair or replacement for defects discovered and reported to us within that one year period. However, even if within the warranty period we accept absolutely no liability for any loss caused by natural disasters or improper product use.

Copying or reprinting the contents described in this material in whole or in part is prohibited without our prior permission.

HAMAMATSU

www.hamamatsu.com

HAMAMATSU PHOTONICS K.K., Solid State Division

1126-1 Ichino-cho, Higashi-ku, Hamamatsu City, 435-8558 Japan, Telephone: (81) 53-434-3311, Fax: (81) 53-434-5184

U.S.A.: Hamamatsu Corporation: 360 Foothill Road, P.O.Box 6910, Bridgewater, N.J. 08807-0910, U.S.A., Telephone: (1) 908-231-0960, Fax: (1) 908-231-1218

Germany: Hamamatsu Photonics Deutschland GmbH: Arzbergerstr. 10, D-82211 Herrsching am Ammersee, Germany, Telephone: (49) 8152-375-0, Fax: (49) 8152-265-8

France: Hamamatsu Photonics France S.A.R.L.: 19, Rue du Saule Trapu, Parc du Moulin de Massy, 91882 Massy Cedex, France, Telephone: 33-(1) 69 53 71 00, Fax: 33-(1) 69 53 71 10

United Kingdom: Hamamatsu Photonics UK Limited: 2 Howard Court, 10 Tewin Road, Welwyn Garden City, Hertfordshire AL7 1BW, United Kingdom, Telephone: (44) 1707-294888, Fax: (44) 1707-325777

North Europe: Hamamatsu Photonics Norden AB: Thorshamnsgatan 35 16440 Kista, Sweden, Telephone: (46) 8-509-031-00, Fax: (46) 8-509-031-01

Italy: Hamamatsu Photonics Italia S.R.L.: Strada della Moia, 1 int. 6, 20020 Arese, (Milano), Italy, Telephone: (39) 02-935-81-733, Fax: (39) 02-935-81-741

China: Hamamatsu Photonics (China) Co., Ltd.: 1201 Tower B, Jiaming Center, No.27 Dongsanhuan Beilu, Chaoyang District, Beijing 100020, China, Telephone: (86) 10-6586-6006, Fax: (86) 10-6586-2866