

## ACGRBT301-HF Thru. ACGRBT305-HF

Glass Passivated Type

Reverse Voltage: 200 to 1000 Volts

Forward Current: 3.0 Amp

RoHS Device

Halogen Free

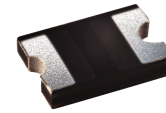

### Features

- Glass passivated cavity-free junction.
- Lead less chip form, no lead damage.
- Low forward voltage drop.
- Plastic package has Underwriters lammability classification 94V-0.
- Comply with AEC-Q101

### Mechanical data

- Case: Packed with FRP substrate and epoxy underfilled.
- Terminals: Pure Tin plated (Lead-Free), solderable per MIL-STD-750, method 2026.
- Polarity: Cathode Band, Laser marking.
- Weight: 0.04 grams (approx).

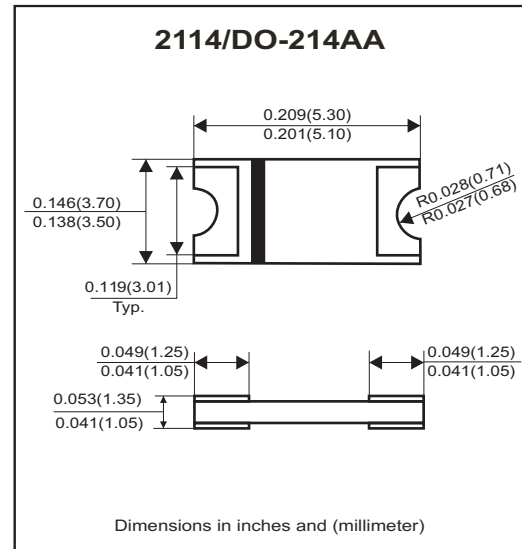

### Circuit Diagram



### Absolute Maximum Ratings (at TA=25°C unless otherwise noted)

Parameter	Symbol	ACGRBT 301-HF	ACGRBT 302-HF	ACGRBT 303-HF	ACGRBT 304-HF	ACGRBT 305-HF	Units	
Max. Repetitive peak reverse voltage	V <sub>RRM</sub>	200	400	600	800	1000	V	
Peak forward surge current, 8.3ms single half sine-wave superimposed on rate load (JEDEC method)	I <sub>FSM</sub>	95						A
Max. Average forward current	I <sub>o</sub>	3.0						A
Operating junction temperature	T <sub>J</sub>	-65 to +175						°C
Storage temperature	T <sub>STG</sub>	-65 to +175						°C

### Electrical Characteristics (at TA=25°C unless otherwise noted)

Parameter	Conditions	Symbol	MIN.	TYP.	MAX.	Unit
Forward voltage	I <sub>F</sub> = 3.0A	V <sub>F</sub>	-	0.94	1.00	V
Repetitive peak reverse current	V <sub>R</sub> = Max. V <sub>RRM</sub> , TA=25°C	I <sub>RRM</sub>	-	0.10	5	uA
Junction capacitance	V <sub>R</sub> =4V, f=1.0MHz	C <sub>J</sub>	-	23	-	pF
Thermal Resistance	Junction to ambient (Note)	R <sub>θJA</sub>	-	74	-	°C/W
	Junction to lead (Note)	R <sub>θJL</sub>	-	10	-	

Notes: 1. Thermal resistance from junction to ambient and from junction to lead P.C.B. mounted on 0.2×0.2”(5.0×5.0mm) copper pad areas.

## RATING AND CHARACTERISTIC CURVES (ACGRBT301-HF thru ACGRBT305-HF)

FIG.1 - FORWARD CURRENT DERATING CURVE

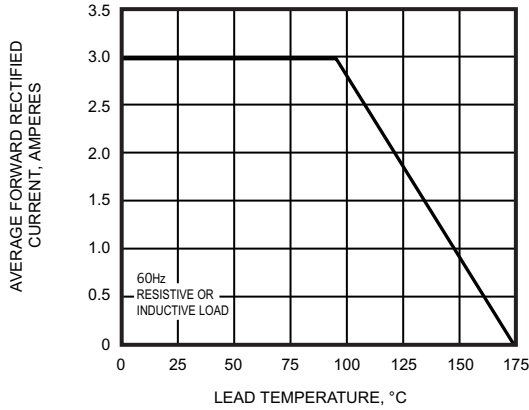

FIG.2 - MAXIMUM NON-REPETITIVE PEAK FORWARD SURGE CURRENT

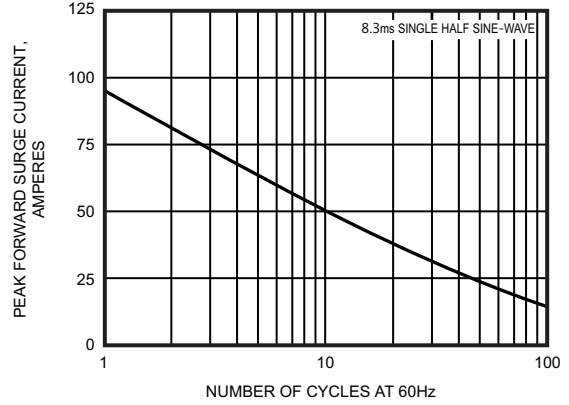

FIG.3 - TYPICAL INSTANTANEOUS FORWARD CHARACTERISTICS

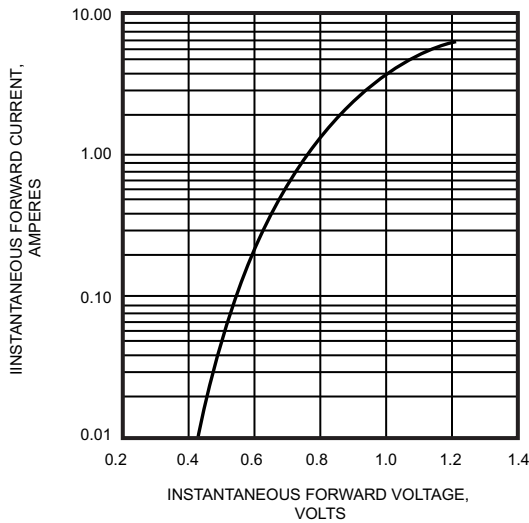

FIG.4 - TYPICAL REVERSE CHARACTERISTICS

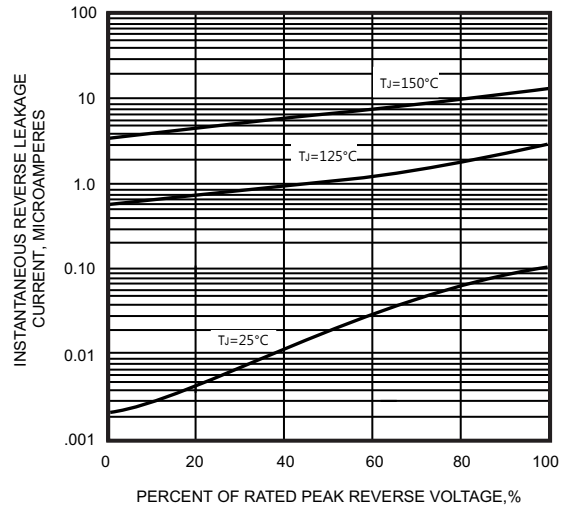
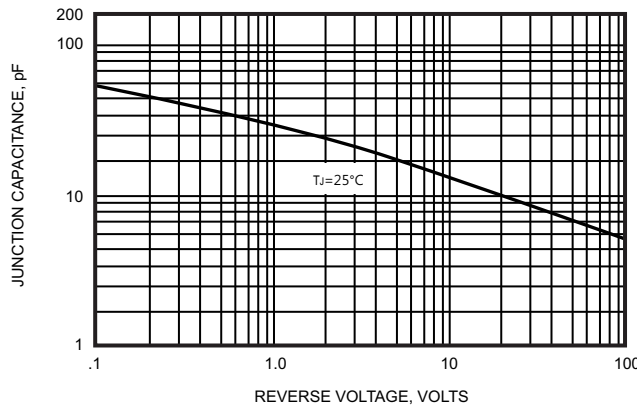
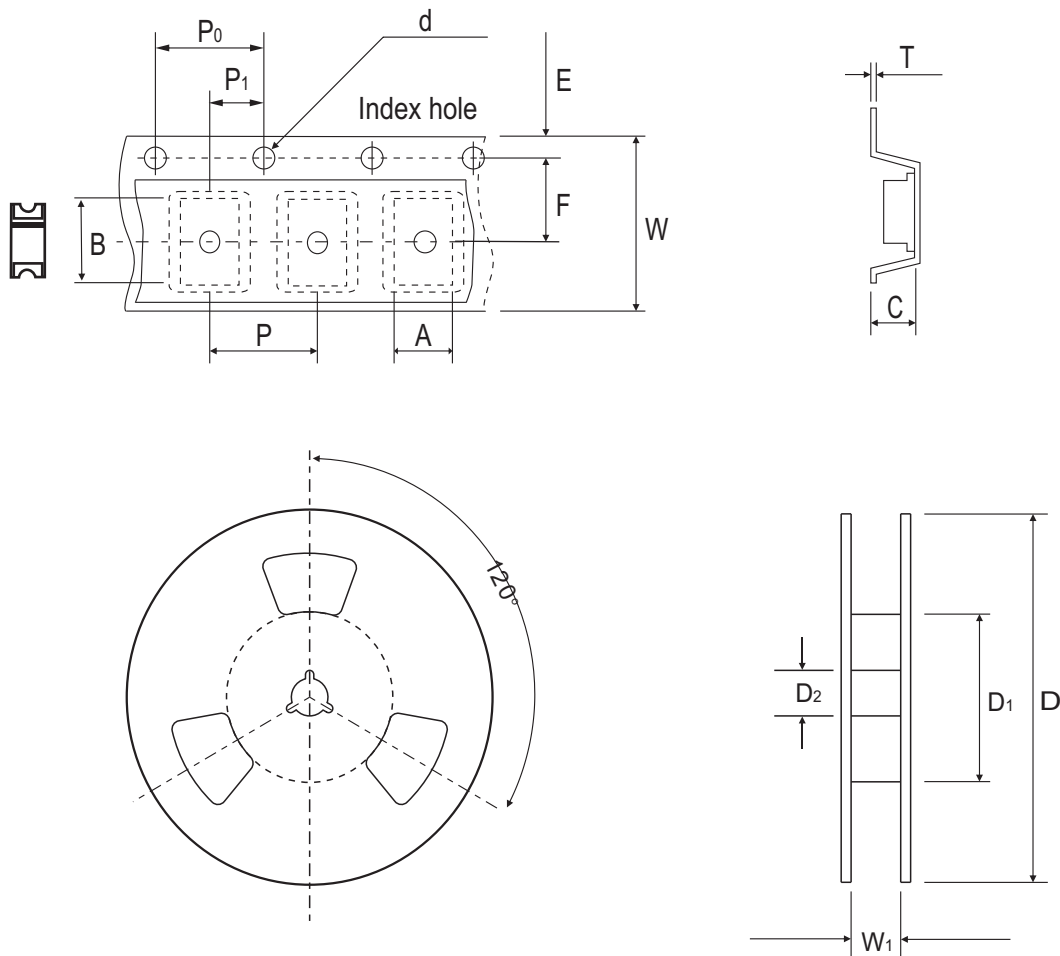

FIG.5 - TYPICAL JUNCTION CAPACITANCE



## Reel Taping Specification



2114 (DO-214AA)	SYMBOL	A	B	C	d	D	D <sub>1</sub>	D <sub>2</sub>
	(mm)	3.95 ± 0.10	5.55 ± 0.10	1.45 ± 0.10	1.50 ± 0.10	330 ± 2.00	50.0 MIN.	13.0 ± 0.50
	(inch)	0.156 ± 0.004	0.219 ± 0.004	0.057 ± 0.004	0.059 ± 0.004	12.992 ± 0.079	1.969 MIN.	0.512 ± 0.020

2114 (DO-214AA)	SYMBOL	E	F	P	P <sub>0</sub>	P <sub>1</sub>	W	W <sub>1</sub>
	(mm)	1.75 ± 0.10	5.50 ± 0.05	8.00 ± 0.10	4.00 ± 0.10	2.00 ± 0.10	12.00 ± 0.30	14.4 MAX.
	(inch)	0.069 ± 0.004	0.217 ± 0.002	0.315 ± 0.004	0.157 ± 0.004	0.079 ± 0.004	0.472 ± 0.012	0.567 MAX.

Company reserves the right to improve product design , functions and reliability without notice.

REV:A

## Marking Code

Part Number	Marking Code
ACGRBT301-HF	30D
ACGRBT302-HF	30G
ACGRBT303-HF	30J
ACGRBT304-HF	30K
ACGRBT305-HF	30M



**XXX = Product type marking code**

## Suggested PAD Layout

SIZE	2114/DO-214AA	
	(mm)	(inch)
<b>A</b>	3.00MIN.	0.118MIN.
<b>B</b>	2.65MAX.	0.104MAX.
<b>C</b>	6.65REF.	0.262 REF.

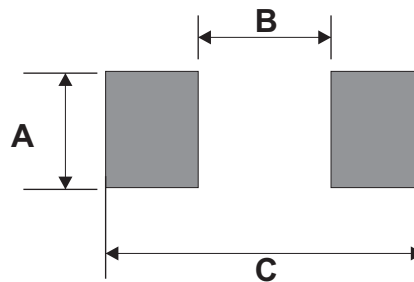

## Standard Packaging

Case Type	REEL PACK	
	REEL ( pcs )	Reel Size (inch)
2114/DO-214AA	5,000	13