

<1mV Voltage Offset, 600MHz Amplifiers

The EL5156, EL5157, EL5256, and EL5257 are 600MHz bandwidth -3dB voltage mode feedback amplifiers with DC accuracy of <math><0.01\%</math>, 1mV offsets and 40kV/V open loop gains. These amplifiers are ideally suited for applications ranging from precision measurement instrumentation to high speed video and monitor applications demanding the very highest linearity at very high frequency. Capable of operating with as little as 6.0mA of current from a single supply ranging from 5V to 12V and dual supplies ranging from $\pm 2.5\text{V}$ to $\pm 5.0\text{V}$, these amplifiers are also well suited for handheld, portable and battery-powered equipment. With their capability to output as much as 140mA, any member of this family is comfortable with demanding load conditions.

Single amplifiers are available in SOT-23 packages and duals in a 10 Ld MSOP package for applications where board space is critical. Additionally, singles and duals are available in the industry-standard 8 Ld SOIC package. All parts operate over the industrial temperature range of -40°C to $+85^{\circ}\text{C}$.

Features

- 600MHz -3dB bandwidth, 240MHz 0.1dB bandwidth
- 700V/ μs slew rate
- <math><1\text{mV}</math> input offset
- Very high open loop gains 92dB
- Low supply current = 6mA
- 140mA output current
- Single supplies from 5V to 12V
- Dual supplies from $\pm 2.5\text{V}$ to $\pm 5\text{V}$
- Fast disable on the EL5156 and EL5256
- Low cost
- Pb-free available (RoHS compliant)

Applications

- Imaging
- Instrumentation
- Video
- Communications devices

Pinouts

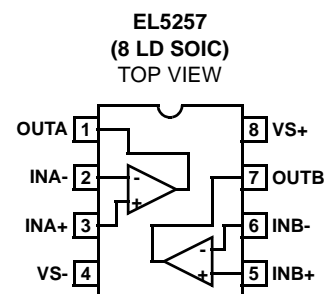
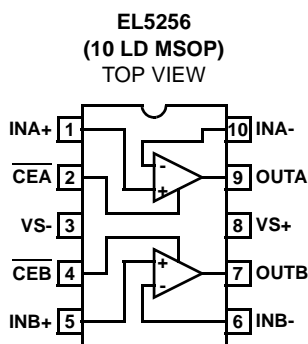
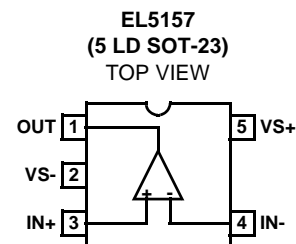
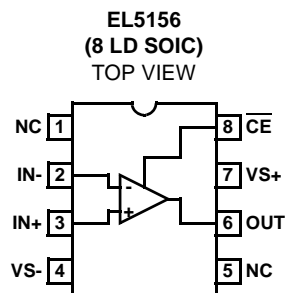

Ordering Information

PART NUMBER	PART MARKING	PACKAGE	PKG. DWG. #
EL5156IS	5156IS	8 Ld SOIC (150 mil)	MDP0027
EL5156IS-T7*	5156IS	8 Ld SOIC (150 mil)	MDP0027
EL5156IS-T13*	5156IS	8 Ld SOIC (150 mil)	MDP0027
EL5156ISZ (Note)	5156ISZ	8 Ld SOIC (150 mil) (Pb-free)	MDP0027
EL5156ISZ-T7* (Note)	5156ISZ	8 Ld SOIC (150 mil) (Pb-free)	MDP0027
EL5156ISZ-T13* (Note)	5156ISZ	8 Ld SOIC (150 mil) (Pb-free)	MDP0027
EL5157IW-T7*	BHAA	5 Ld SOT-23	MDP0038
EL5157IW-T7A*	BHAA	5 Ld SOT-23	MDP0038
EL5157IWZ-T7* (Note)	BAAM	5 Ld SOT-23 (Pb-free)	MDP0038
EL5157IWZ-T7A* (Note)	BAAM	5 Ld SOT-23 (Pb-free)	MDP0038
EL5256Y	BAHAA	10 Ld MSOP (3.0mm)	MDP0043
EL5256Y-T7*	BAHAA	10 Ld MSOP (3.0mm)	MDP0043
EL5256Y-T13*	BAHAA	10 Ld MSOP (3.0mm)	MDP0043
EL5257IS	5257IS	8 Ld SOIC (150 mil)	MDP0027
EL5257IS-T7*	5257IS	8 Ld SOIC (150 mil)	MDP0027
EL5257IS-T13*	5257IS	8 Ld SOIC (150 mil)	MDP0027
EL5257Y	BAJAA	8 Ld MSOP (3.0mm)	MDP0043
EL5257Y-T7*	BAJAA	8 Ld MSOP (3.0mm)	MDP0043
EL5257Y-T13*	BAJAA	8 Ld MSOP (3.0mm)	MDP0043

*Please refer to TB347 for details on reel specifications.

NOTE: These Intersil Pb-free plastic packaged products employ special Pb-free material sets; molding compounds/die attach materials and 100% matte tin plate PLUS ANNEAL - e3 termination finish, which is RoHS compliant and compatible with both SnPb and Pb-free soldering operations. Intersil Pb-free products are MSL classified at Pb-free peak reflow temperatures that meet or exceed the Pb-free requirements of IPC/JEDEC J STD-020.

EL5156, EL5157, EL5256, EL5257

Absolute Maximum Ratings (T_A = +25°C)

Supply Voltage between V _S and V _S ⁻	13.2V
Maximum Slewrate from V _S ⁺ and V _S ⁻	1V/μs
Maximum Continuous Output Current	50mA
Current into I _N ⁺ , I _N ⁻ , CE	5mA
Pin Voltages	GND -0.5V to V _S +0.5V

Thermal Information

Junction Temperature	+125°C
Storage Temperature	-65°C to +150°C
Ambient Operating Temperature	-40°C to +85°C
Power Dissipation	See Curves
Pb-free reflow profile	see link below
	http://www.intersil.com/pbfree/Pb-FreeReflow.asp

CAUTION: Do not operate at or near the maximum ratings listed for extended periods of time. Exposure to such conditions may adversely impact product reliability and result in failures not covered by warranty.

IMPORTANT NOTE: All parameters having Min/Max specifications are guaranteed. Typical values are for information purposes only. Unless otherwise noted, all tests are at the specified temperature and are pulsed tests, therefore: T_J = T_C = T_A

Electrical Specifications V_S⁺ = +5V, V_S⁻ = -5V, \overline{CE} = +5V, R_F = R_G = 562Ω, R_L = 150Ω, T_A = +25°C, Unless Otherwise Specified.

PARAMETER	DESCRIPTION	CONDITIONS	MIN (Note 1)	TYP	MAX (Note 1)	UNIT
AC PERFORMANCE						
BW	-3dB Bandwidth	A _V = +1, R _L = 500Ω, C _L = 4.7pF		600		MHz
		A _V = +2, R _L = 150Ω		180		MHz
GBWP	Gain Bandwidth Product	R _L = 150Ω		210		MHz
BW1	0.1dB Bandwidth	A _V = +2		70		MHz
SR	Slew Rate	V _O = -3.2V to +3.2V, A _V = +2, R _L = 150Ω	500	640		V/μs
		V _O = -3.2V to +3.2V, A _V = +1, R _L = 500Ω		700		V/μs
t _S	0.1% Settling Time	A _V = +1		15		ns
dG	Differential Gain Error	A _V = +2, R _L = 150Ω		0.005		%
dP	Differential Phase Error	A _V = +2, R _L = 150Ω		0.04		°
V _N	Input Referred Voltage Noise			12		nV/√Hz
I _N	Input Referred Current Noise			5.5		pA/√Hz
DC PERFORMANCE						
V _{OS}	Offset Voltage		-1	0.5	1	mV
T _C V _{OS}	Input Offset Voltage Temperature Coefficient	Measured from T _{MIN} to T _{MAX}		-3		μV/°C
A _{VOL}	Open Loop Gain	V _O is from -2.5V to 2.5V	10	40		kV/V
INPUT CHARACTERISTICS						
CMIR	Common Mode Input Range	Guaranteed by CMRR test	-2.5		+2.5	V
CMRR	Common Mode Rejection Ratio	V _{CM} = 2.5V to -2.5V	80	108		dB
I _B	Input Bias Current	EL5156 and EL5157	-1	-0.4	+1	μA
		EL5256 and EL5257	-600	-200	+600	nA
I _{OS}	Input Offset Current		-250	100	+250	nA
R _{IN}	Input Resistance		10	25		MΩ
C _{IN}	Input Capacitance			1		pF
OUTPUT CHARACTERISTICS						
V _{OUT}	Output Voltage Swing	R _L = 150Ω to GND	±3.4	±3.6		V
		R _L = 500Ω to GND	±3.6	±3.8		V
I _{OUT}	Peak Output Current	R _L = 10Ω to GND	±80	±140		mA

EL5156, EL5157, EL5256, EL5257

Electrical Specifications $V_{S+} = +5V$, $V_{S-} = -5V$, $\overline{CE} = +5V$, $R_F = R_G = 562\Omega$, $R_L = 150\Omega$, $T_A = +25^\circ C$, Unless Otherwise Specified. (Continued)

PARAMETER	DESCRIPTION	CONDITIONS	MIN (Note 1)	TYP	MAX (Note 1)	UNIT
ENABLE (EL5156 and EL5256 ONLY)						
t_{EN}	Enable Time			200		ns
t_{DIS}	Disable Time			300		ns
I_{IHCE}	\overline{CE} Pin Input High Current	$\overline{CE} = V_{S+}$		13	25	μA
I_{ILCE}	\overline{CE} Pin Input Low Current	$\overline{CE} = V_{S-}$		0	1	μA
V_{IHCE}	\overline{CE} Input High Voltage for Power-down		$V_{S+} - 1$			V
V_{ILCE}	\overline{CE} Input Low Voltage for Power-up				$V_{S+} - 3$	V
SUPPLY						
I_{SON}	Supply Current - Enabled (per amplifier)	No load, $V_{IN} = 0V$, $\overline{CE} = +5V$	5.1	6.0	6.9	mA
I_{SOFF}	Supply Current - Disabled (per amplifier)	No load, $V_{IN} = 0V$, $\overline{CE} = 5V$	5	13	25	μA
PSRR	Power Supply Rejection Ratio	DC, $V_S = \pm 3.0V$ to $\pm 6.0V$	75	90		dB

NOTE:

- Parts are 100% tested at $+25^\circ C$. Over-temperature limits established by characterization and are not production tested.

Typical Performance Curves

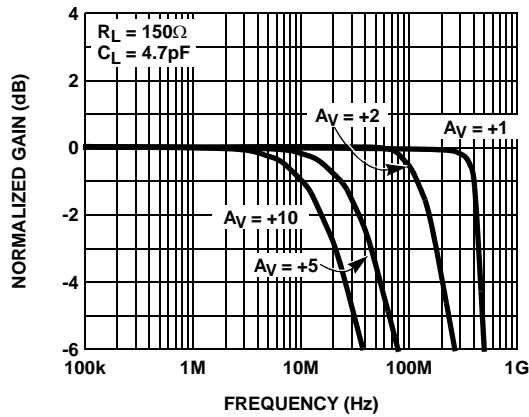

FIGURE 1. SMALL SIGNAL FREQUENCY RESPONSE - GAIN

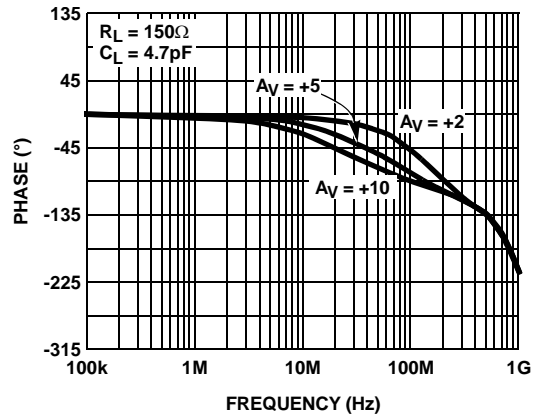

FIGURE 2. SMALL SIGNAL FREQUENCY RESPONSE - PHASE FOR VARIOUS GAINS

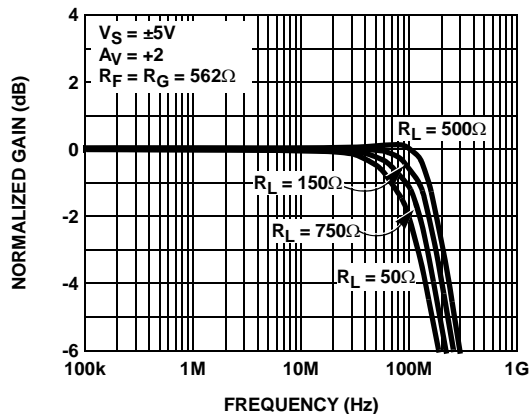

FIGURE 3. SMALL SIGNAL FREQUENCY RESPONSE FOR VARIOUS R_L

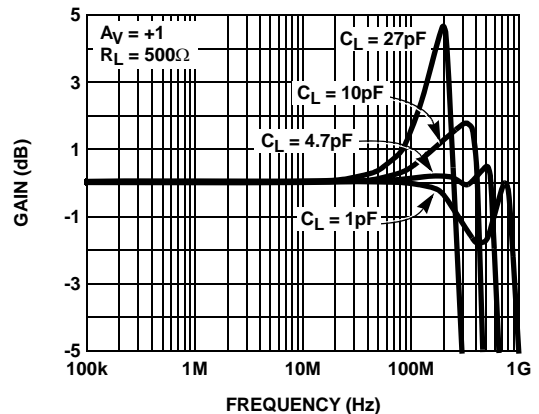

FIGURE 4. SMALL SIGNAL FREQUENCY RESPONSE FOR VARIOUS C_L

Typical Performance Curves (Continued)

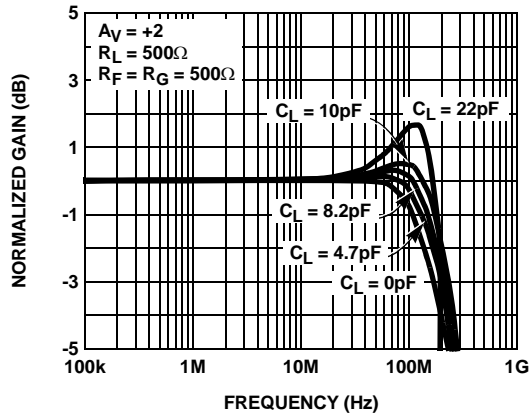

FIGURE 5. SMALL SIGNAL FREQUENCY RESPONSE FOR VARIOUS C_L

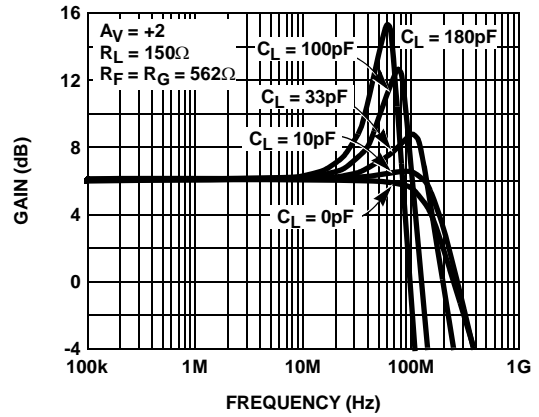

FIGURE 6. SMALL SIGNAL FREQUENCY RESPONSE FOR VARIOUS C_L

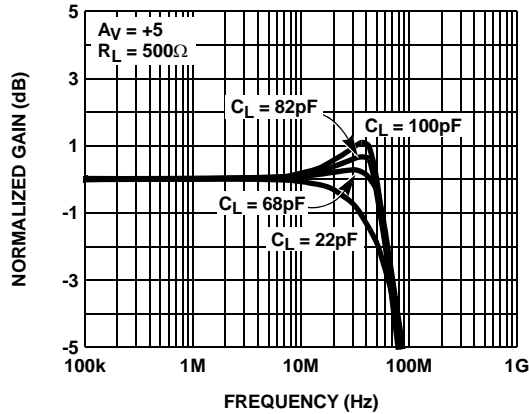

FIGURE 7. SMALL SIGNAL FREQUENCY RESPONSE FOR VARIOUS C_L

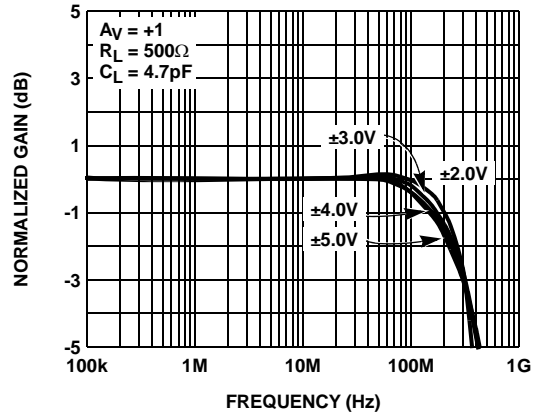

FIGURE 8. FREQUENCY RESPONSE vs POWER SUPPLY

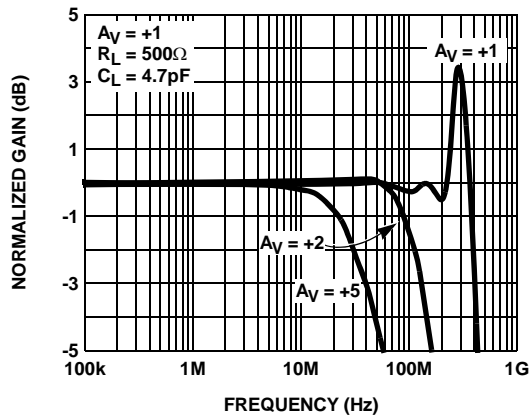

FIGURE 9. EL5256 SMALL SIGNAL FREQUENCY RESPONSE FOR VARIOUS GAINS

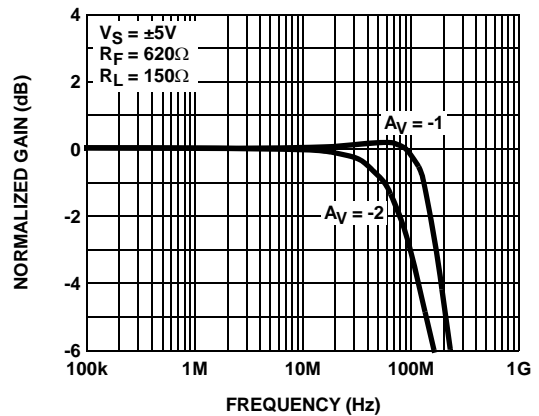

FIGURE 10. SMALL SIGNAL INVERTING FREQUENCY RESPONSE FOR VARIOUS GAINS

Typical Performance Curves (Continued)

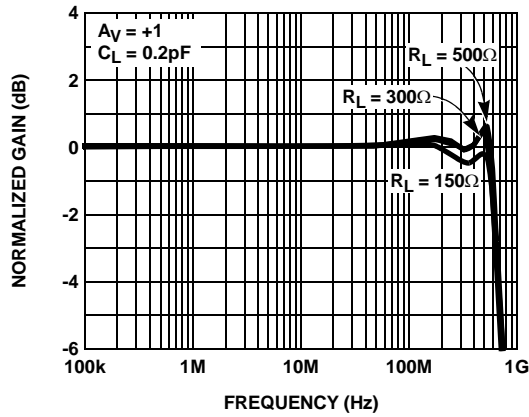

FIGURE 11. SMALL SIGNAL FREQUENCY RESPONSE FOR VARIOUS R_L

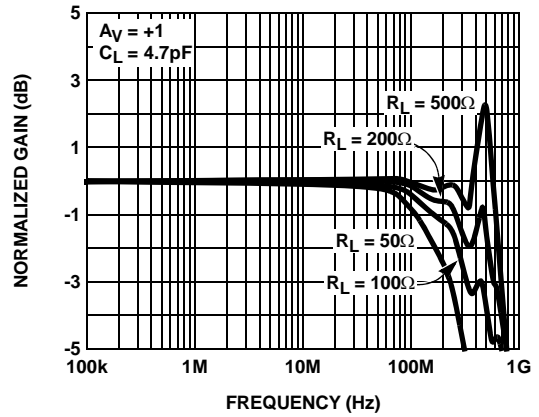

FIGURE 12. EL5256 SMALL SIGNAL FREQUENCY RESPONSE FOR VARIOUS R_L

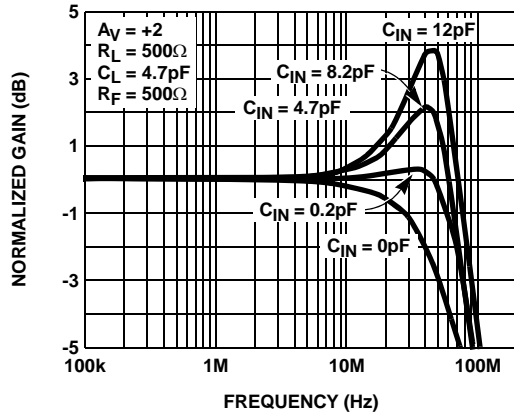

FIGURE 13. SMALL SIGNAL FREQUENCY RESPONSE FOR VARIOUS C_{IN}

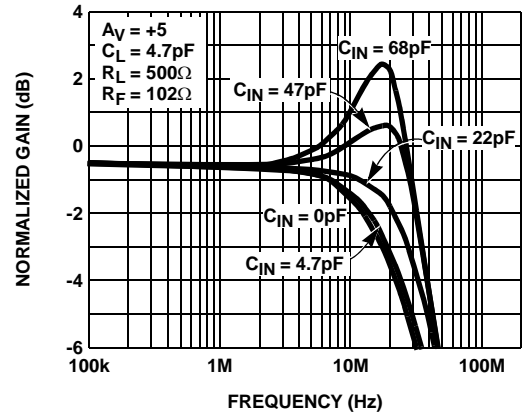

FIGURE 14. SMALL SIGNAL FREQUENCY RESPONSE FOR VARIOUS C_{IN}

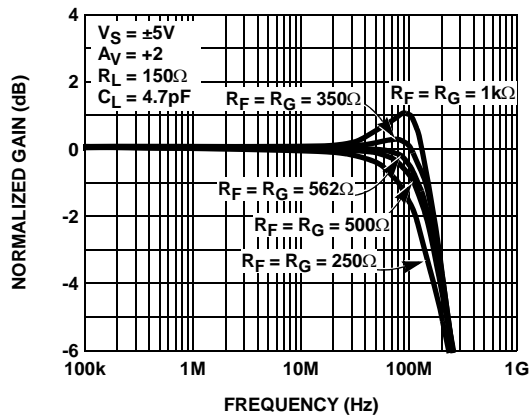

FIGURE 15. SMALL SIGNAL FREQUENCY RESPONSE FOR VARIOUS R_F AND R_G

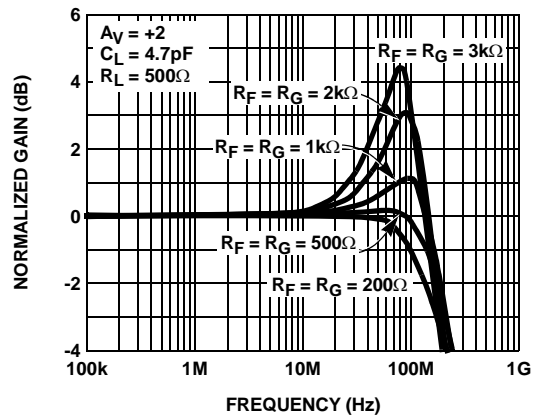

FIGURE 16. EL5256 SMALL SIGNAL FREQUENCY RESPONSE FOR VARIOUS R_F AND R_G

Typical Performance Curves (Continued)

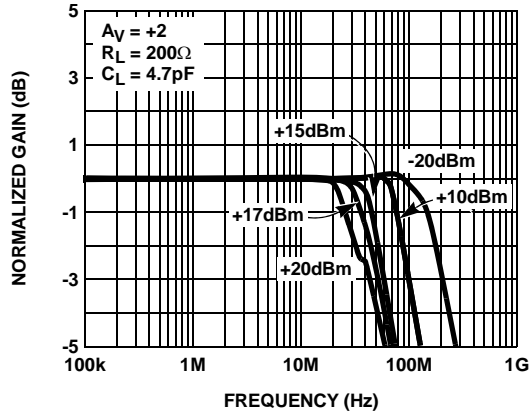

FIGURE 17. LARGE SIGNAL FREQUENCY RESPONSE FOR VARIOUS INPUT AMPLITUDES

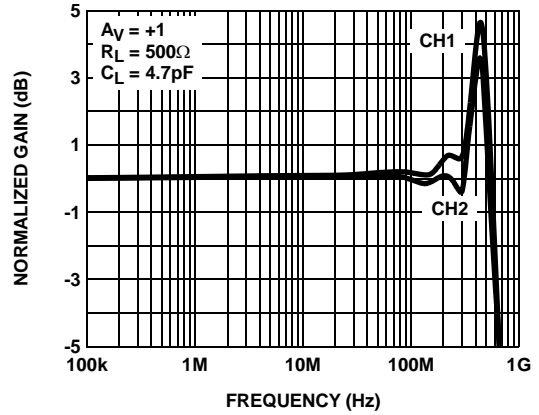

FIGURE 18. CHANNEL TO CHANNEL FREQUENCY RESPONSE

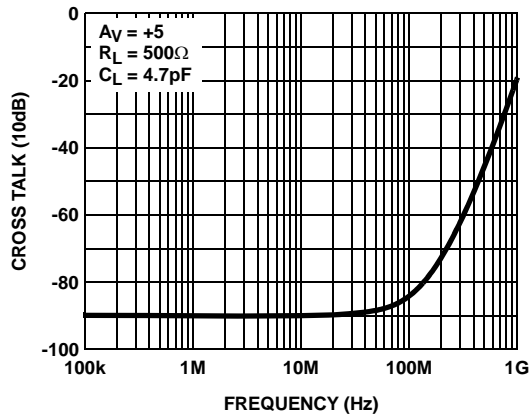

FIGURE 19. EL5256 CROSSTALK vs FREQUENCY CHANNEL A TO B AND B TO A

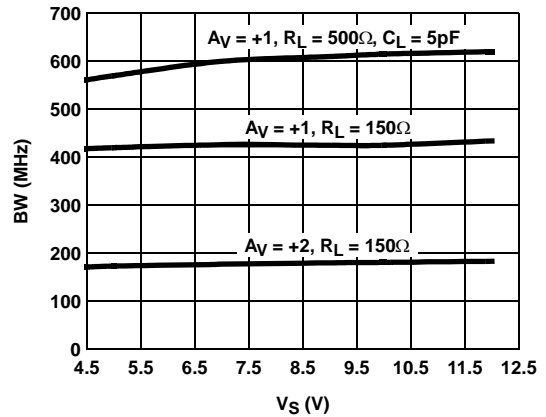

FIGURE 20. BANDWIDTH vs SUPPLY VOLTAGE

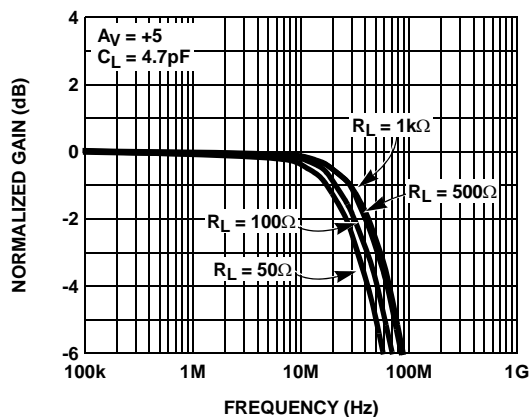

FIGURE 21. SMALL SIGNAL FREQUENCY RESPONSE FOR VARIOUS R_L

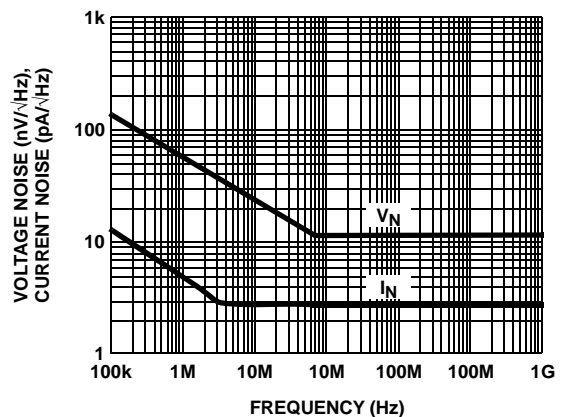

FIGURE 22. VOLTAGE AND CURRENT NOISE vs FREQUENCY

Typical Performance Curves (Continued)

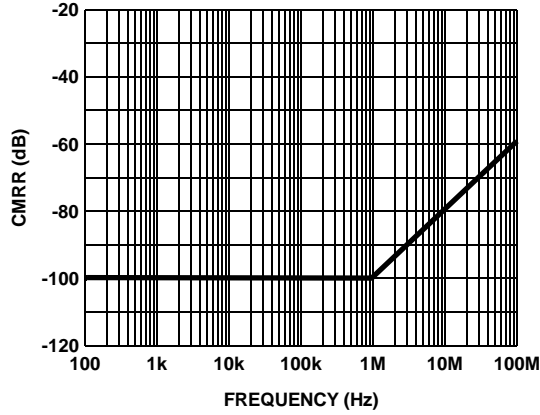

FIGURE 23. CMRR

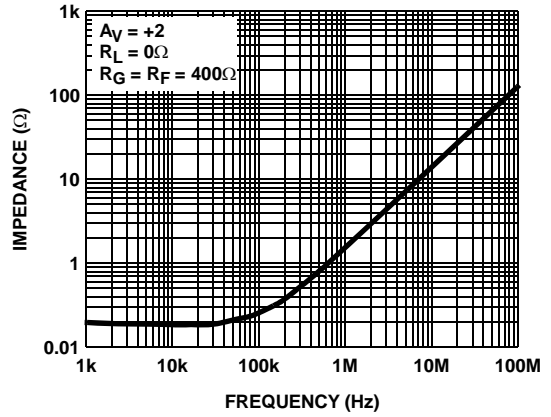

FIGURE 24. OUTPUT IMPEDANCE

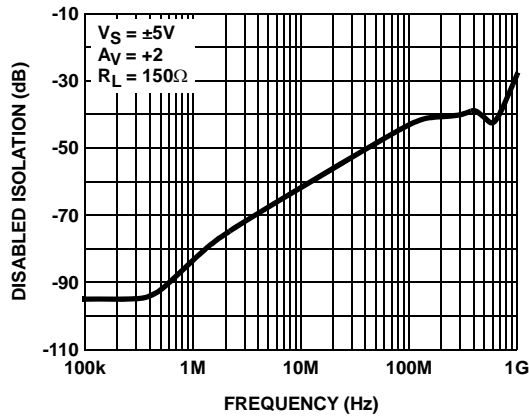

FIGURE 25. INPUT TO OUTPUT ISOLATION vs FREQUENCY - DISABLE

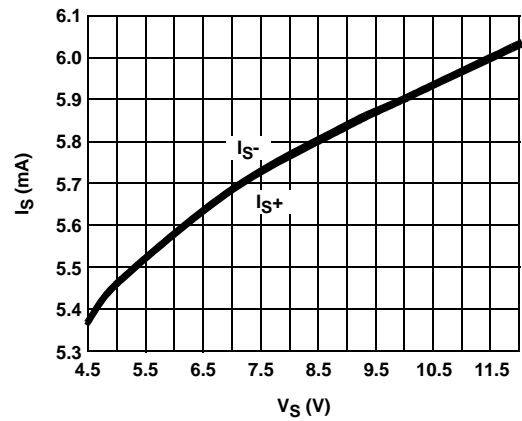

FIGURE 26. SUPPLY CURRENT vs SUPPLY VOLTAGE

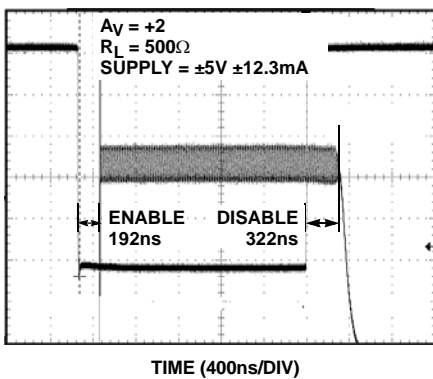

FIGURE 27. ENABLE/DISABLE RESPONSE

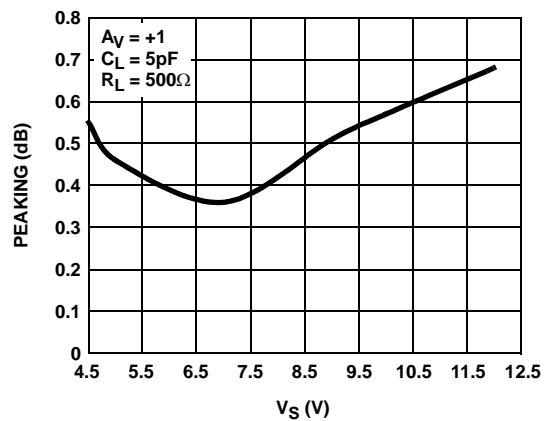

FIGURE 28. PEAKING vs SUPPLY VOLTAGE

Typical Performance Curves (Continued)

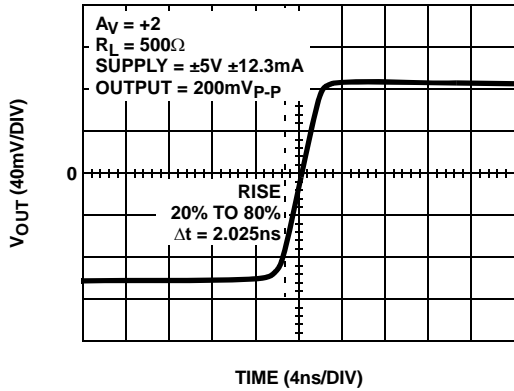

FIGURE 29. SMALL SIGNAL RISE TIME

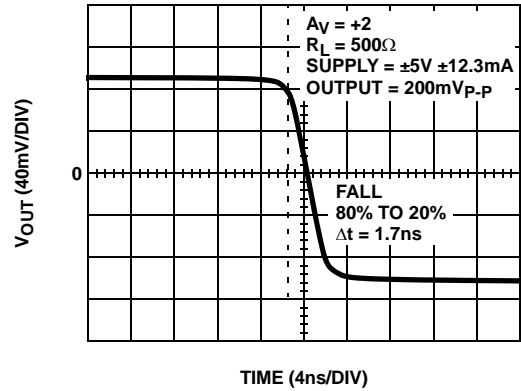

FIGURE 30. SMALL SIGNAL FALL TIME

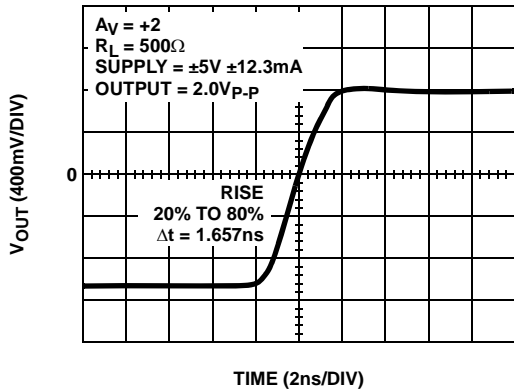

FIGURE 31. LARGE SIGNAL RISE TIME

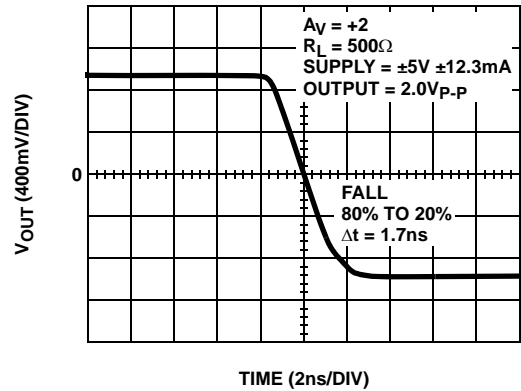

FIGURE 32. LARGE SIGNAL FALL TIME

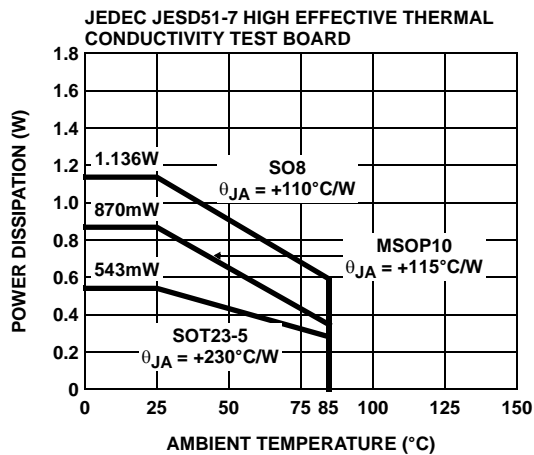

FIGURE 33. PACKAGE POWER DISSIPATION vs AMBIENT TEMPERATURE

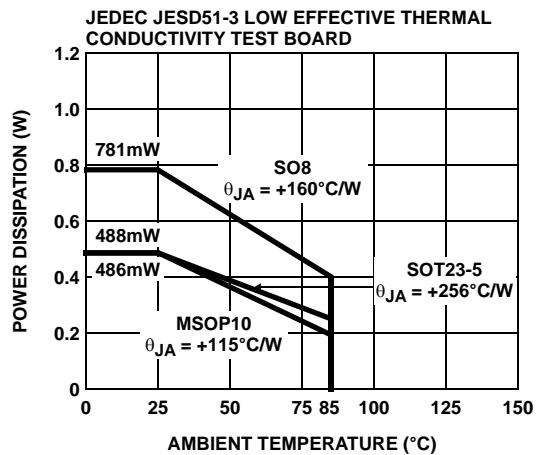

FIGURE 34. PACKAGE POWER DISSIPATION vs AMBIENT TEMPERATURE

EL5156 Product Description

The EL5156, EL5157, EL5256, and EL5257 are wide bandwidth, single or dual supply, low power and low offset voltage feedback operational amplifiers. Both amplifiers are internally compensated for closed loop gain of +1 or greater. Connected in voltage follower mode and driving a 500Ω load, the -3dB bandwidth is about 610MHz. Driving a 150Ω load and a gain of 2, the bandwidth is about 180MHz while maintaining a 600V/μs slew rate. The EL5156 and EL5256 are available with a power-down pin to reduce power to 17μA typically while the amplifier is disabled.

Input, Output and Supply Voltage Range

The EL5156 and EL5157 families have been designed to operate with supply voltage from 5V to 12V. That means for single supply application, the supply voltage is from 5V to 12V. For split supplies application, the supply voltage is from ±2.5V to ±5V. The amplifiers have an input common mode voltage range from 1.5V above the negative supply (VS- pin) to 1.5V below the positive supply (VS+ pin). If the input signal is outside the above specified range, it will cause the output signal to be distorted.

The outputs of the EL5156 and EL5157 families can swing from -4V to 4V for $V_S = \pm 5V$. As the load resistance becomes lower, the output swing is lower. If the load resistor is 500Ω, the output swing is about -4V at a 4V supply. If the load resistor is 150Ω, the output swing is from -3.5V to 3.5V.

Choice of Feedback Resistor and Gain Bandwidth Product

For applications that require a gain of +1, no feedback resistor is required. Just short the output pin to the inverting input pin. For gains greater than +1, the feedback resistor forms a pole with the parasitic capacitance at the inverting input. As this pole becomes smaller, the amplifier's phase margin is reduced. This causes ringing in the time domain and peaking in the frequency domain. Therefore, R_F can't be very big for optimum performance. If a large value of R_F must be used, a small capacitor in the few Pico farad range in parallel with R_F can help to reduce the ringing and peaking at the expense of reducing the bandwidth.

For gain of +1, $R_F = 0$ is optimum. For the gains other than +1, optimum response is obtained with R_F between 500Ω to 750Ω.

The EL5156 and EL5157 families have a gain bandwidth product of 210MHz. For gains ≥ 5 , its bandwidth can be predicted by Equation 1:

$$\text{Gain} \times \text{BW} = 210\text{MHz} \quad (\text{EQ. 1})$$

Video Performance

For good video performance, an amplifier is required to maintain the same output impedance and the same frequency response as DC levels are changed at the output.

This is especially difficult when driving a standard video load of 150Ω, because of the change in output current with DC level. The dG and dP for these families are about 0.006% and 0.04%, while driving 150Ω at a gain of 2. Driving high impedance loads would give a similar or better dG and dP performance.

Driving Capacitive Loads and Cables

The EL5156 and EL5157 families can drive 27pF loads in parallel with 500Ω with less than 5dB of peaking at gain of +1. If less peaking is desired in applications, a small series resistor (usually between 5Ω to 50Ω) can be placed in series with the output to eliminate most peaking. However, this will reduce the gain slightly. If the gain setting is greater than 1, the gain resistor R_G can then be chosen to make up for any gain loss which may be created by the additional series resistor at the output.

When used as a cable driver, double termination is always recommended for reflection-free performance. For those applications, a back-termination series resistor at the amplifier's output will isolate the amplifier from the cable and allow extensive capacitive drive. However, other applications may have high capacitive loads without a back-termination resistor. Again, a small series resistor at the output can help to reduce peaking.

Disable/Power-Down

The EL5156 and EL5256 can be disabled and their output placed in a high impedance state. The turn-off time is about 330ns and the turn-on time is about 130ns. When disabled, the amplifier's supply current is reduced to 17μA typically, thereby effectively eliminating the power consumption. The amplifier's power-down can be controlled by standard TTL or CMOS signal levels at the ENABLE pin. The applied logic signal is relative to VS- pin. Letting the ENABLE pin float or applying a signal that is less than 0.8V above VS- will enable the amplifier. The amplifier will be disabled when the signal at ENABLE pin is above $V_{S+} - 1.5V$.

Output Drive Capability

The EL5156 and EL5157 families do not have internal short circuit protection circuitry. They have a typical short circuit current of 95mA and 70mA. If the output is shorted indefinitely, the power dissipation could easily overheat the die or the current could eventually compromise metal integrity. Maximum reliability is maintained if the output current never exceeds ±40mA. This limit is set by the design of the internal metal interconnect. Note that in transient applications, the part is robust.

Power Dissipation

With the high output drive capability of the EL5152 and EL5153 families, it is possible to exceed the +125°C absolute maximum junction temperature under certain load current conditions. Therefore, it is important to calculate the maximum junction temperature for an application to

determine if load conditions or package types need to be modified to assure operation of the amplifier in a safe operating area.

The maximum power dissipation allowed in a package is determined according to Equation 2:

$$PD_{MAX} = \frac{T_{JMAX} - T_{AMAX}}{\theta_{JA}} \quad (\text{EQ. 2})$$

Where:

T_{JMAX} = Maximum junction temperature

T_{AMAX} = Maximum ambient temperature

θ_{JA} = Thermal resistance of the package

The maximum power dissipation actually produced by an IC is the total quiescent supply current times the total power supply voltage, plus the power in the IC due to the load, or:

For sourcing:

$$PD_{MAX} = V_S \times I_{SMAX} + \sum_{i=1}^n (V_S - V_{OUTi}) \times \frac{V_{OUTi}}{R_{Li}} \quad (\text{EQ. 3})$$

For sinking:

$$PD_{MAX} = V_S \times I_{SMAX} + \sum_{i=1}^n (V_{OUTi} - V_S) \times I_{LOADi} \quad (\text{EQ. 4})$$

Where:

V_S = Supply voltage

I_{SMAX} = Maximum quiescent supply current

V_{OUT} = Maximum output voltage of the application

R_{LOAD} = Load resistance tied to ground

I_{LOAD} = Load current

N = number of amplifiers (max = 2)

By setting the two PD_{MAX} equations equal to each other, we can solve the output current and R_{LOAD} to avoid the device overheat.

Power Supply Bypassing Printed Circuit Board Layout

As with any high frequency device, a good printed circuit board layout is necessary for optimum performance. Lead lengths should be as short as possible. The power supply pin must be well bypassed to reduce the risk of oscillation. For normal single supply operation, where the V_S- pin is connected to the ground plane, a single 4.7 μ F tantalum capacitor in parallel with a 0.1 μ F ceramic capacitor from V_S+ to GND will suffice. This same capacitor combination should be placed at each supply pin to ground if split supplies are to be used. In this case, the V_S- pin becomes the negative supply rail. See Figure 37 for a complete tuned power supply bypass methodology.

Printed Circuit Board Layout

For good AC performance, parasitic capacitance should be kept to a minimum. Use of wire wound resistors should be avoided because of their additional series inductance. Use of sockets should also be avoided if possible. Sockets add parasitic inductance and capacitance that can result in compromised performance. Minimizing parasitic capacitance at the amplifier's inverting input pin is very important. The feedback resistor should be placed very close to the inverting input pin. Strip line design techniques are recommended for the signal traces.

Application Circuits

Sallen Key Low Pass Filter

A common and easy to implement filter taking advantage of the wide bandwidth, low offset and low power demands of the EL5152. A derivation of the transfer function is provided for convenience (See Figure 35).

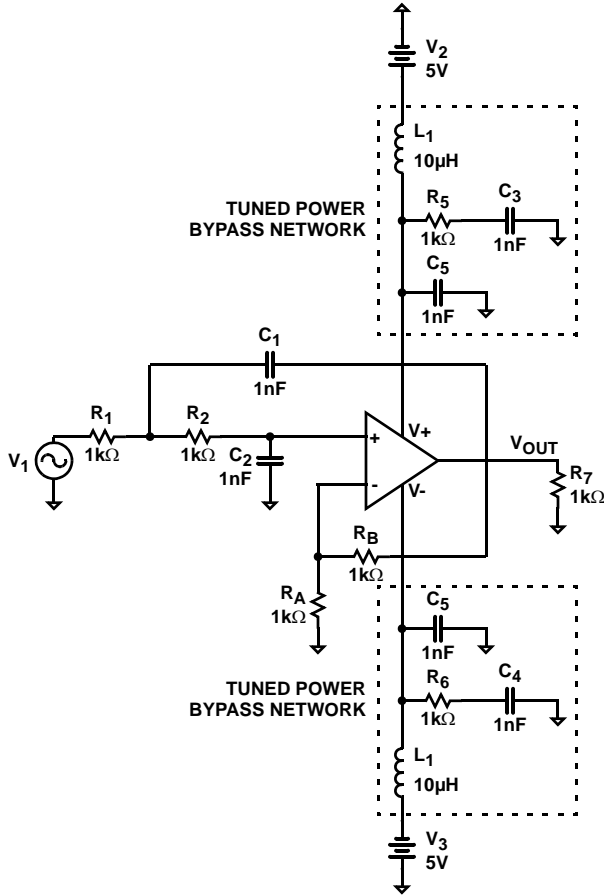

FIGURE 35. SALLEN KEY LOW PASS FILTER

Sallen Key High Pass Filter

Again this useful filter benefits from the characteristics of the EL5152. The transfer function is very similar to the low pass so only the results are presented (See Figure 36).

$$K = 1 + \frac{R_B}{R_A}$$

$$V_O = K \cdot \frac{1}{R_2 \cdot C_2 s + 1} \cdot V_i$$

$$\frac{V_1 - V_i}{R_1} + \frac{K - V_1}{R_2} + \frac{V_O - V_i}{C_1 s} = 0$$

$$H(s) = \frac{K}{R_1 C_1 R_2 C_2 s^2 + ((1 - K)R_1 C_1 + R_1 C_2 + R_2 C_2) s + 1}$$

$$H(j\omega) = \frac{1}{1 - \omega^2 R_1 C_1 R_2 C_2 + j\omega((1 - K)R_1 C_1 + R_1 C_2 + R_2 C_2)}$$

$$H_{olp} = K$$

$$\omega_o = \frac{1}{\sqrt{R_1 C_1 R_2 C_2}}$$

$$Q = \frac{1}{(1 - K) \sqrt{\frac{R_1 C_1}{R_2 C_2}} + \sqrt{\frac{R_1 C_2}{R_2 C_1}} + \sqrt{\frac{R_2 C_2}{R_1 C_1}}}$$

$$H_{olp} = K$$

$$\omega_o = \frac{1}{RC}$$

$$Q = \frac{1}{3 - K}$$

Equations simplify if we let all components be equal to R = C

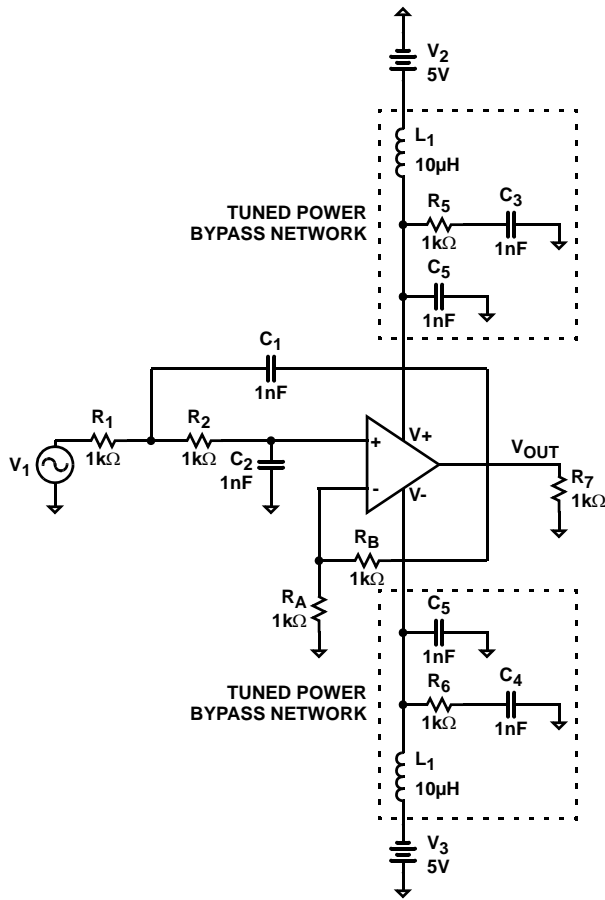

$$H_{olp} = K$$

$$\omega_0 = \frac{1}{\sqrt{R_1 C_1 R_2 C_2}}$$

$$Q = \frac{1}{(1-K) \sqrt{\frac{R_1 C_1}{R_2 C_2} + \sqrt{\frac{R_1 C_2}{R_2 C_1} + \sqrt{\frac{R_2 C_2}{R_1 C_1}}}}$$

$$H_{olp} = \frac{K}{4-K}$$

$$\omega_0 = \frac{\sqrt{2}}{RC}$$

$$Q = \frac{\sqrt{2}}{4-K}$$

Equations simplify if we let all components be equal to $R = C$

FIGURE 36. SALLEN KEY HIGH PASS FILTER

Differential Output Instrumentation Amplifier

The addition of a third amplifier to the conventional three amplifier instrumentation amplifier introduces the benefits of differential signal realization, specifically the advantage of using common mode rejection to remove coupled noise and ground potential errors inherent in remote transmission. This configuration also provides enhanced bandwidth, wider output swing and faster slew rate than conventional three amplifier solutions with only the cost of an additional amplifier and a few resistors.

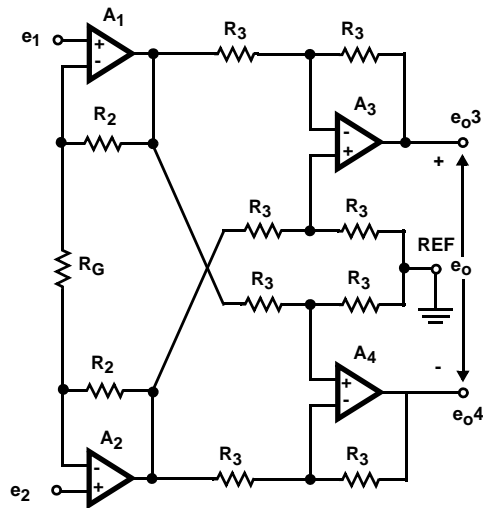

$$e_{o3} = -(1 + 2R_2/R_G)(e_1 - e_2) \quad e_{o4} = (1 + 2R_2/R_G)(e_1 - e_2)$$

$$e_o = -2(1 + 2R_2/R_G)(e_1 - e_2)$$

$$BW = \frac{2f_{C1,2}}{|A_{Di}|} \quad A_{Di} = -2(1 + 2R_2/R_G)$$

Strain Gauge

The strain gauge is an ideal application to take advantage of the moderate bandwidth and high accuracy of the EL5152. The operation of the circuit is very straightforward. As the strain variable component resistor in the balanced bridge is subjected to increasing strain, its resistance changes,

resulting in an imbalance in the bridge. A voltage variation from the referenced high accuracy source is generated and translated to the difference amplifier through the buffer stage. This voltage difference as a function of the strain is converted into an output voltage.

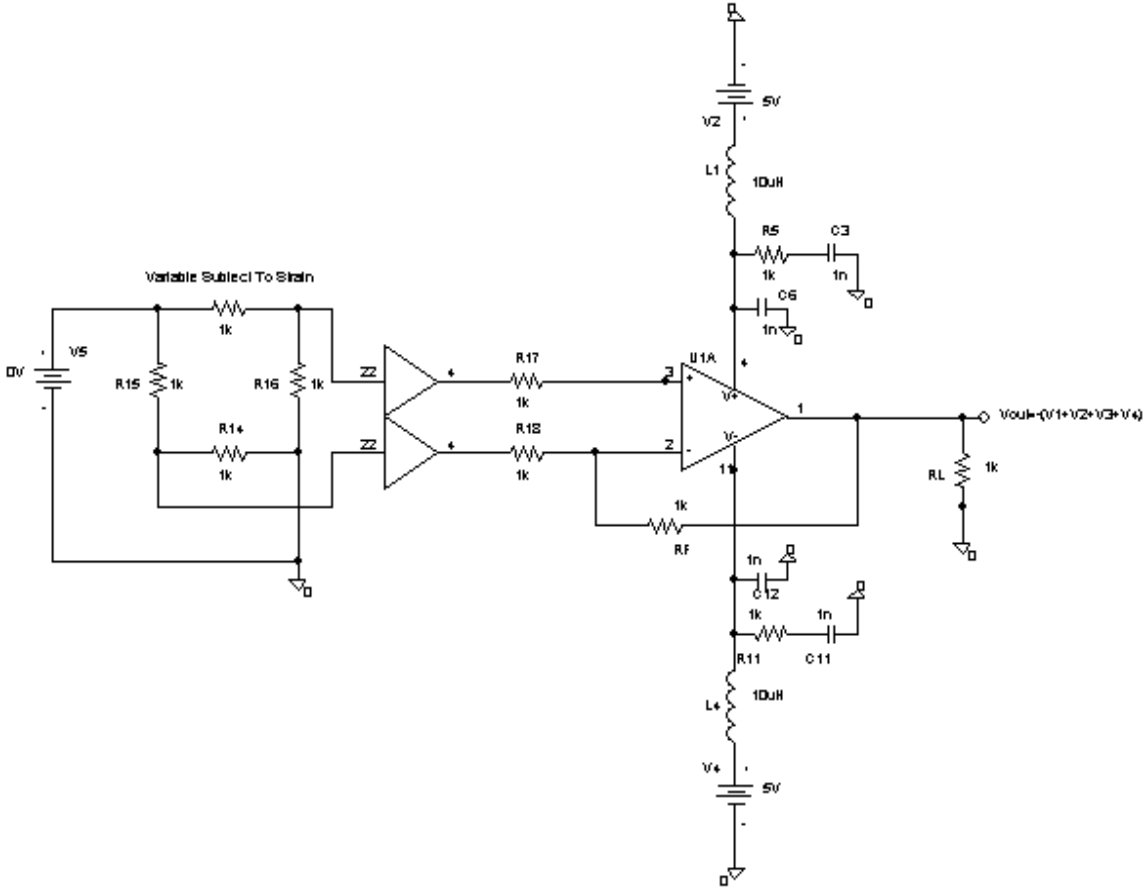
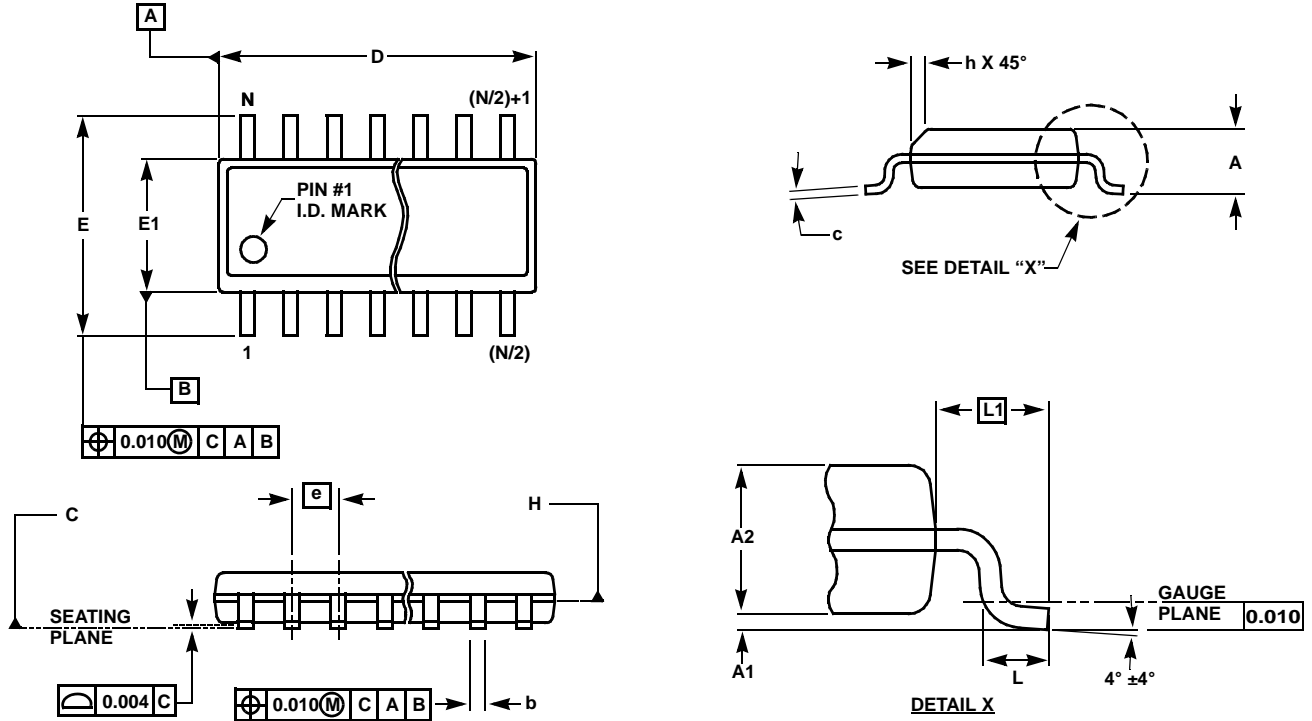

FIGURE 37. STRAIN GAUGE OPERATIONAL CIRCUIT

Small Outline Package Family (SO)



MDP0027

SMALL OUTLINE PACKAGE FAMILY (SO)

SYMBOL	INCHES							TOLERANCE	NOTES
	SO-8	SO-14	SO16 (0.150")	SO16 (0.300") (SOL-16)	SO20 (SOL-20)	SO24 (SOL-24)	SO28 (SOL-28)		
A	0.068	0.068	0.068	0.104	0.104	0.104	0.104	MAX	-
A1	0.006	0.006	0.006	0.007	0.007	0.007	0.007	± 0.003	-
A2	0.057	0.057	0.057	0.092	0.092	0.092	0.092	± 0.002	-
b	0.017	0.017	0.017	0.017	0.017	0.017	0.017	± 0.003	-
c	0.009	0.009	0.009	0.011	0.011	0.011	0.011	± 0.001	-
D	0.193	0.341	0.390	0.406	0.504	0.606	0.704	± 0.004	1, 3
E	0.236	0.236	0.236	0.406	0.406	0.406	0.406	± 0.008	-
E1	0.154	0.154	0.154	0.295	0.295	0.295	0.295	± 0.004	2, 3
e	0.050	0.050	0.050	0.050	0.050	0.050	0.050	Basic	-
L	0.025	0.025	0.025	0.030	0.030	0.030	0.030	± 0.009	-
L1	0.041	0.041	0.041	0.056	0.056	0.056	0.056	Basic	-
h	0.013	0.013	0.013	0.020	0.020	0.020	0.020	Reference	-
N	8	14	16	16	20	24	28	Reference	-

Rev. M 2/07

NOTES:

1. Plastic or metal protrusions of 0.006" maximum per side are not included.
2. Plastic interlead protrusions of 0.010" maximum per side are not included.
3. Dimensions "D" and "E1" are measured at Datum Plane "H".
4. Dimensioning and tolerancing per ASME Y14.5M-1994

SOT-23 Package Family

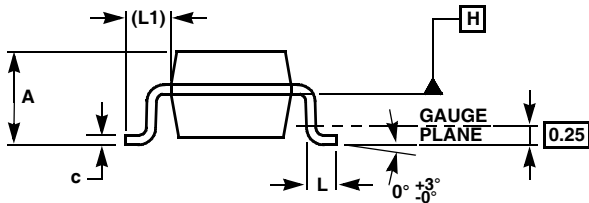
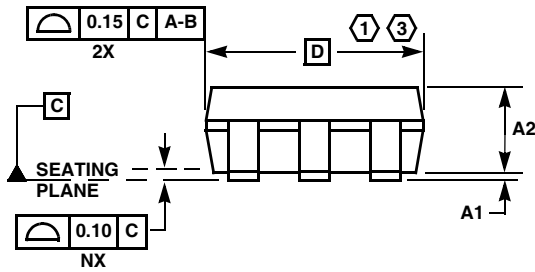
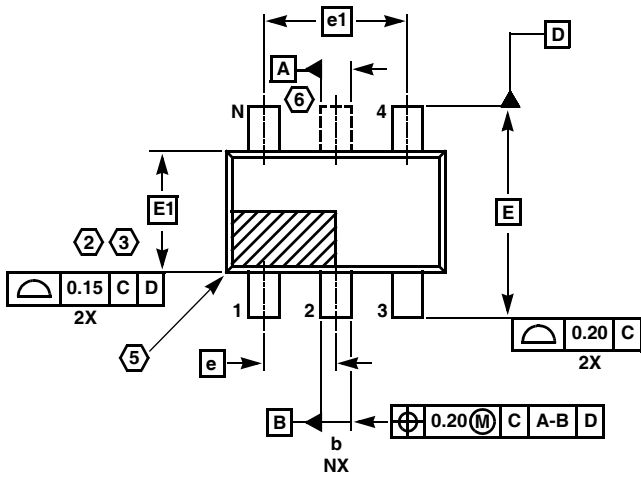

MDP0038

SOT-23 PACKAGE FAMILY

SYMBOL	MILLIMETERS		TOLERANCE
	SOT23-5	SOT23-6	
A	1.45	1.45	MAX
A1	0.10	0.10	±0.05
A2	1.14	1.14	±0.15
b	0.40	0.40	±0.05
c	0.14	0.14	±0.06
D	2.90	2.90	Basic
E	2.80	2.80	Basic
E1	1.60	1.60	Basic
e	0.95	0.95	Basic
e1	1.90	1.90	Basic
L	0.45	0.45	±0.10
L1	0.60	0.60	Reference
N	5	6	Reference

Rev. F 2/07

NOTES:

1. Plastic or metal protrusions of 0.25mm maximum per side are not included.
2. Plastic interlead protrusions of 0.25mm maximum per side are not included.
3. This dimension is measured at Datum Plane "H".
4. Dimensioning and tolerancing per ASME Y14.5M-1994.
5. Index area - Pin #1 I.D. will be located within the indicated zone (SOT23-6 only).
6. SOT23-5 version has no center lead (shown as a dashed line).

Mini SO Package Family (MSOP)

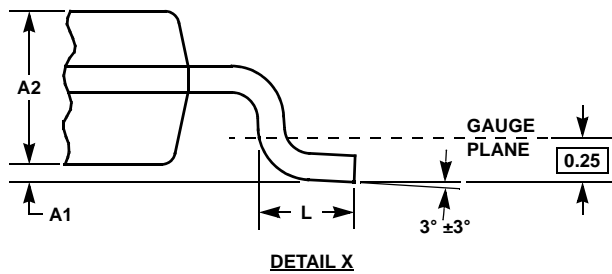
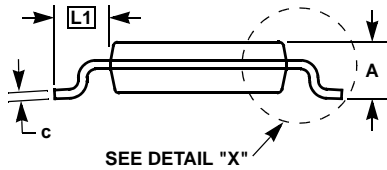
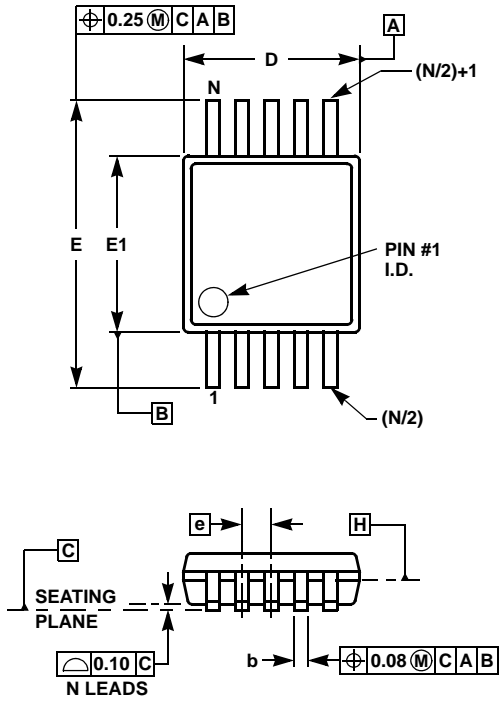

MDP0043
MINI SO PACKAGE FAMILY

SYMBOL	MILLIMETERS		TOLERANCE	NOTES
	MSOP8	MSOP10		
A	1.10	1.10	Max.	-
A1	0.10	0.10	±0.05	-
A2	0.86	0.86	±0.09	-
b	0.33	0.23	+0.07/-0.08	-
c	0.18	0.18	±0.05	-
D	3.00	3.00	±0.10	1, 3
E	4.90	4.90	±0.15	-
E1	3.00	3.00	±0.10	2, 3
e	0.65	0.50	Basic	-
L	0.55	0.55	±0.15	-
L1	0.95	0.95	Basic	-
N	8	10	Reference	-

Rev. D 2/07

NOTES:

1. Plastic or metal protrusions of 0.15mm maximum per side are not included.
2. Plastic interlead protrusions of 0.25mm maximum per side are not included.
3. Dimensions "D" and "E1" are measured at Datum Plane "H".
4. Dimensioning and tolerancing per ASME Y14.5M-1994.

All Intersil U.S. products are manufactured, assembled and tested utilizing ISO9000 quality systems.
Intersil Corporation's quality certifications can be viewed at www.intersil.com/design/quality

Intersil products are sold by description only. Intersil Corporation reserves the right to make changes in circuit design, software and/or specifications at any time without notice. Accordingly, the reader is cautioned to verify that data sheets are current before placing orders. Information furnished by Intersil is believed to be accurate and reliable. However, no responsibility is assumed by Intersil or its subsidiaries for its use; nor for any infringements of patents or other rights of third parties which may result from its use. No license is granted by implication or otherwise under any patent or patent rights of Intersil or its subsidiaries.

For information regarding Intersil Corporation and its products, see www.intersil.com