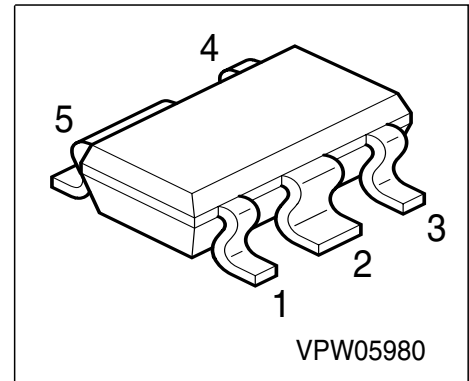

NPN Silicon Germanium RF Transistor

Preliminary data

- For medium power amplifiers
- Maxim. available Gain $G_{ma} = 17$ dB at 1.8 GHz
- Gold metallization for high reliability
- 70 GHz f_T - Silicon Germanium technology

ESD: Electrostatic discharge sensitive device, observe handling precaution!

Type	Marking	Pin Configuration						Package
BFP690	R9s	1=B	2=E	3=C	4=C	5=E	-	SCT595

Maximum Ratings

Parameter	Symbol	Value	Unit
Collector-emitter voltage	V_{CEO}	4	V
Collector-emitter voltage	V_{CES}	13	
Collector-base voltage	V_{CBO}	13	
Emitter-base voltage	V_{EBO}	1.2	
Collector current	I_C	350	mA
Base current	I_B	20	
Total power dissipation ¹⁾ $T_S \leq 80^\circ\text{C}$	P_{tot}	1000	mW
Junction temperature	T_j	150	°C
Ambient temperature	T_A	-65 ... 150	
Storage temperature	T_{stg}	-65 ... 150	

Thermal Resistance

Parameter	Symbol	Value	Unit
Junction - soldering point ²⁾	R_{thJS}	≤ 60	K/W

¹⁾ T_S is measured on the collector lead at the soldering point to the pcb

²⁾ For calculation of R_{thJA} please refer to Application Note Thermal Resistance

Electrical Characteristics at $T_A = 25^\circ\text{C}$, unless otherwise specified

Parameter	Symbol	Values			Unit
		min.	typ.	max.	
DC Characteristics					
Collector-emitter breakdown voltage $I_C = 1 \text{ mA}, I_B = 0 \text{ A}$	$V_{(BR)CEO}$	4	4.5	-	V
Collector-base cutoff current $V_{CB} = 5 \text{ V}, I_E = 0 \text{ A}$	I_{CBO}	-	-	100	nA
Emitter-base cutoff current $V_{EB} = 0.5 \text{ V}, I_C = 0 \text{ A}$	I_{EBO}	-	-	10	μA
DC current gain $I_C = 200 \text{ mA}, V_{CE} = 3 \text{ V}$	h_{FE}	100	180	250	-

Electrical Characteristics at $T_A = 25^\circ\text{C}$, unless otherwise specified

Parameter	Symbol	Values			Unit
		min.	typ.	max.	
AC Characteristics (verified by random sampling)					
Transition frequency $I_C = 200\text{ mA}$, $V_{CE} = 3\text{ V}$, $f = 0.5\text{ GHz}$	f_T	-	37	-	GHz
Collector-base capacitance $V_{CB} = 3\text{ V}$, $f = 1\text{ MHz}$	C_{cb}	-	0.6	-	pF
Collector emitter capacitance $V_{CE} = 3\text{ V}$, $f = 1\text{ MHz}$	C_{ce}	-	1.25	-	
Emitter-base capacitance $V_{EB} = 0.5\text{ V}$, $f = 1\text{ MHz}$	C_{eb}	-	3	-	
Noise figure $I_C = 35\text{ mA}$, $V_{CE} = 3\text{ V}$, $f = 1.8\text{ GHz}$, $Z_S = Z_{Sopt}$ $I_C = 35\text{ mA}$, $V_{CE} = 3\text{ V}$, $f = 3\text{ GHz}$, $Z_S = Z_{Sopt}$	F	-	1 1.2	-	dB
Power gain, maximum available ¹⁾ $I_C = 200\text{ mA}$, $V_{CE} = 3\text{ V}$, $Z_S = Z_{Sopt}$, $Z_L = Z_{Lopt}$, $f = 1.8\text{ GHz}$ $I_C = 200\text{ mA}$, $V_{CE} = 3\text{ V}$, $Z_S = Z_{Sopt}$, $Z_L = Z_{Lopt}$, $f = 3\text{ GHz}$	G_{ma}	-	17.5 13	-	
Transducer gain $I_C = 200\text{ mA}$, $V_{CE} = 3\text{ V}$, $Z_S = Z_L = 50\ \Omega$, $f = 1.8\text{ GHz}$ $I_C = 200\text{ mA}$, $V_{CE} = 3\text{ V}$, $Z_S = Z_L = 50\ \Omega$, $f = 3\text{ GHz}$	$ S_{21e} ^2$	-	11 6.5	-	dB
Third order intercept point at output ²⁾ $V_{CE} = 3\text{ V}$, $I_C = 200\text{ mA}$, $f = 1.8\text{ GHz}$, $Z_S = Z_L = 50\ \Omega$	IP_3	-	29	-	dBm
1dB Compression point at output $I_C = 200\text{ mA}$, $V_{CE} = 3\text{ V}$, $Z_S = Z_L = 50\ \Omega$, $f = 1.8\text{ GHz}$	P_{-1dB}	-	19.5	-	

$$^1G_{ma} = |S_{21} / S_{12}| (k - (k^2 - 1)^{1/2})$$

²⁾IP3 value depends on termination of all intermodulation frequency components.
Termination used for this measurement is 50Ω from 0.1 MHz to 6 GHz

SPICE Parameter (Gummel-Poon Model, Berkley-SPICE 2G.6 Syntax):
Transistor Chip Data:

IS =	1.41	fA	BF =	450	-	NF =	1.025	-
VAF =	1000	-	IKF =	0.9	A	ISE =	145	fA
NE =	2	-	BR =	40	-	NR =	1	-
VAR =	2	V	IKR =	45	mA	ISC =	1.2	pA
NC =	1.8	-	RB =	0.4442	Ω	IRB =	10.61	mA
RBM =	0.3836	Ω	RE =	0.14	-	RC =	0.4312	Ω
CJE =	1.592	fF	VJE =	0.8	V	MJE =	0.3	-
TF =	1.9	ps	XTF =	5	-	VTF =	0.6	V
ITF =	2.9	A	PTF =	0	deg	CJC =	477.5	fF
VJC =	0.6	V	MJC =	0.5	-	XCJC =	1	-
TR =	0.2	ns	CJS =	688.1	fF	VJS =	0.6	V
MJS =	0.27	-	NK =	-1.42	-	EG =	1.078	eV
XTI =	3	-	FC =	0.8	-	TNOM	298	K
AF =	2	-	KF =	1.046E-11	-			
TITF1	-0.0065	-	TITF2	1.0E-5	-			

All parameters are ready to use, no scaling is necessary. Extracted on behalf of Infineon Technologies AG by: Institut für Mobil- und Satellitentechnik (IMST)

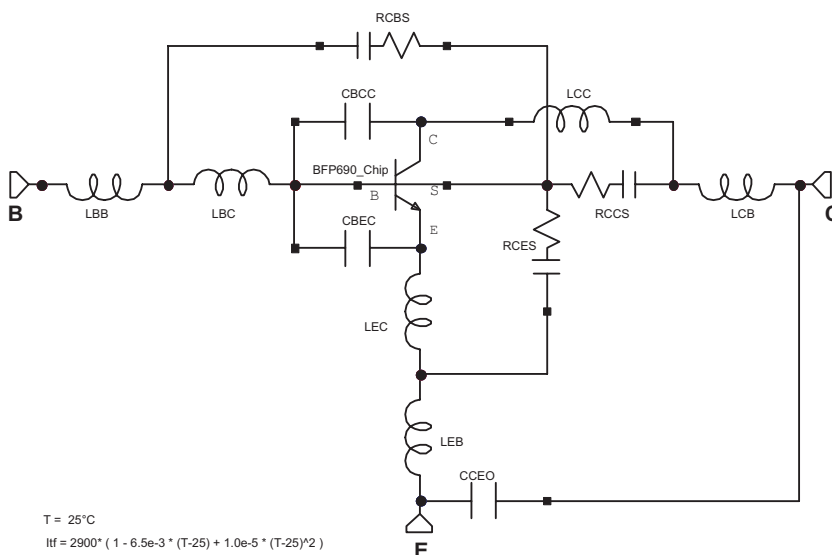
Package Equivalent Circuit:

LBC =	15	pH
LCC =	4	pH
LEC =	4	pH
LBB =	900	pH
LCB =	700	pH
LEB =	130	pH
CBEC =	864.4	fF
CBCC =	399.9	fF
CES =	450	fF
CBS =	535	fF
CCS =	135	fF
CCEO =	130	fF
RBS =	190	Ω
RCS =	340	Ω
RES =	340	Ω

Valid up to 6GHz

For examples and ready to use parameters please contact your local Infineon Technologies distributor or sales office to obtain a Infineon Technologies CD-ROM or see Internet: <http://www.infineon.com/silicondiscretres>

Total power dissipation $P_{tot} = f(T_S)$

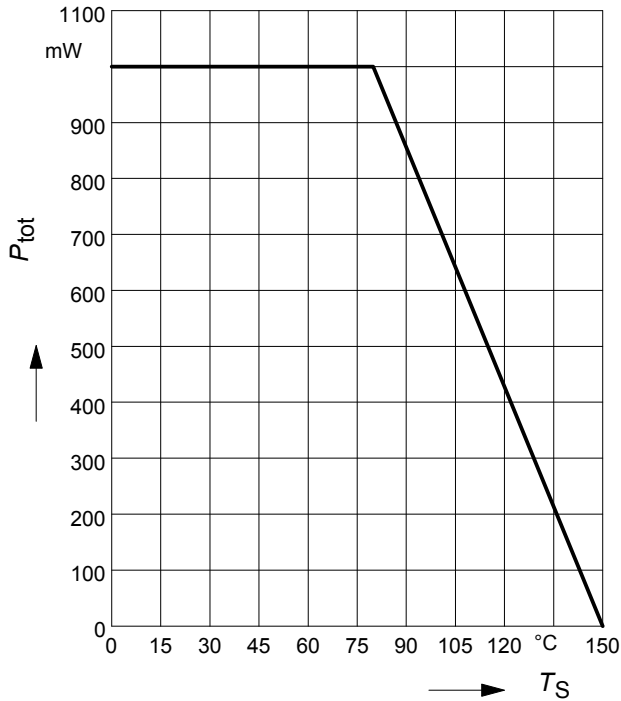

Permissible Pulse Load $R_{thJS} = f(t_p)$

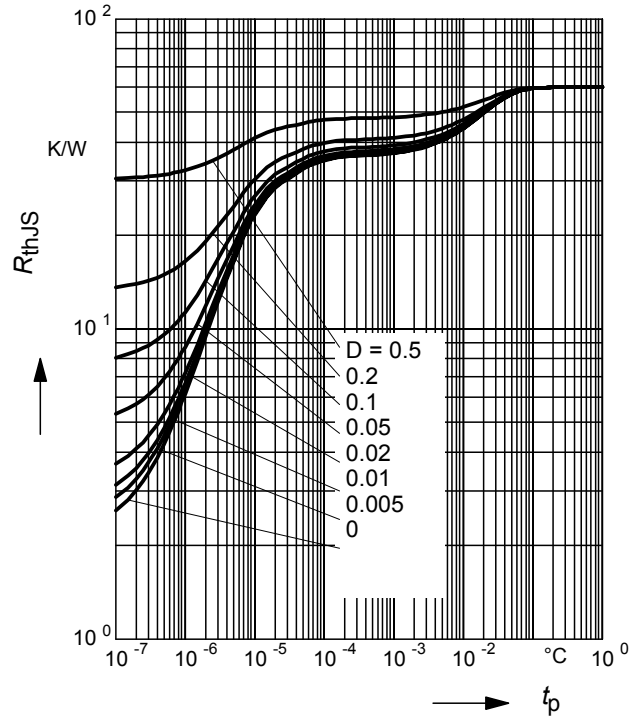

Permissible Pulse Load

$P_{totmax}/P_{totDC} = f(t_p)$

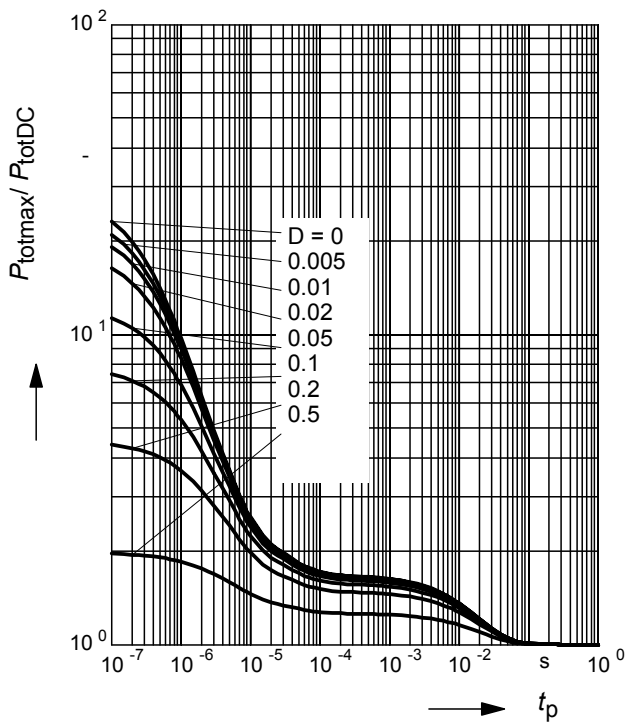

Collector-base capacitance $C_{cb} = f(V_{CB})$

$f = 1\text{MHz}$

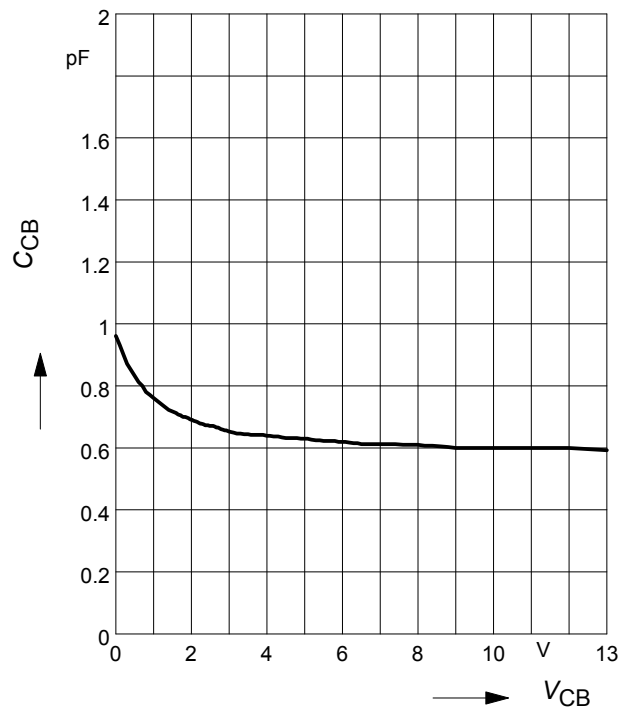

Transition frequency $f_T = f(I_C)$

$f = 0.5\text{GHz}$

$V_{CE} = \text{parameter in V}$

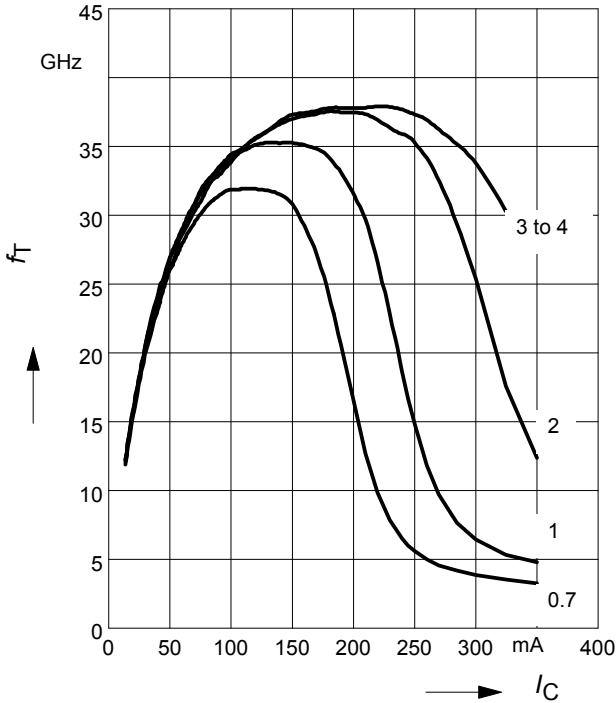

Power Gain $G_{ma}, G_{ms} = f(f)$

$|S_{21}|^2 = f(f)$

$V_{CE} = 3\text{V}, I_C = 200\text{mA}$

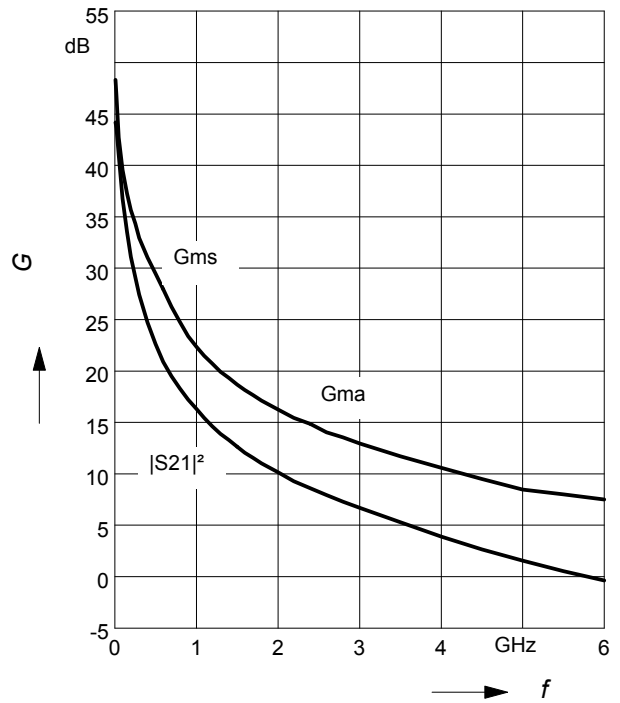

Power gain $G_{ma}, G_{ms} = f(I_C)$

$V_{CE} = 3\text{V}$

$f = \text{parameter}$

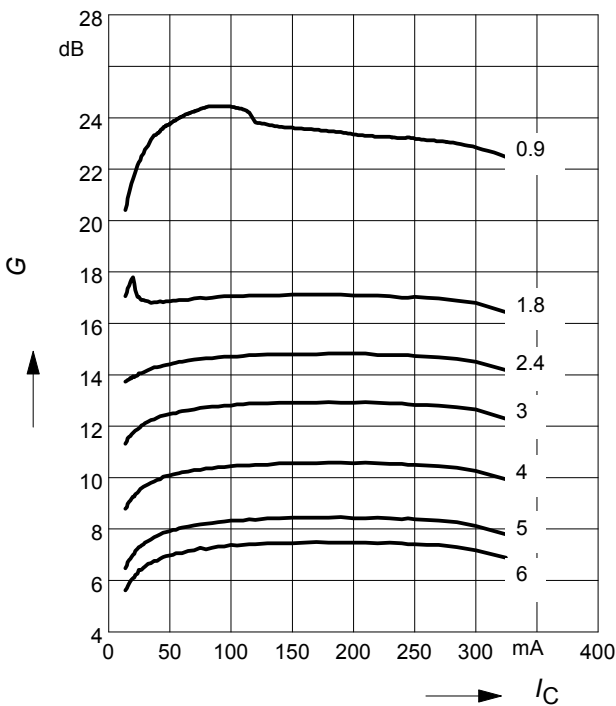

Power gain $G_{ma}, G_{ms} = f(V_{CE})$

$I_C = 200\text{mA}$

$f = \text{parameter in GHz}$

