

50 ohm nominal input / conjugate match balun for STLC2690, with integrated harmonic filter

Datasheet – production data

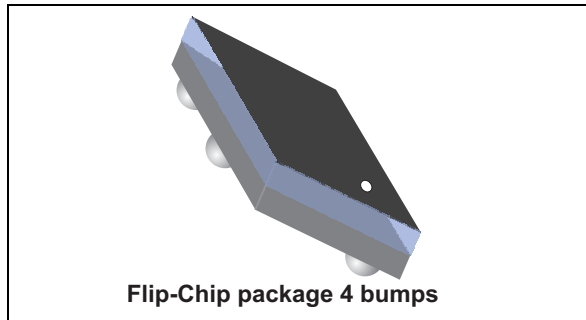

Features

- 50 Ω nominal input / matched output differential impedance
- Integrated harmonic filter
- Low insertion loss
- Low amplitude imbalance
- Low phase imbalance
- Small footprint < 1.54 mm²

Benefits

- Very low profile (< 560 μm after reflow)
- High RF performance
- RF BOM and area reduction

Applications

- Bluetooth STLC2690 application
- Mobile phone application

Description

STMicroelectronics BALF-2690-02D3 is a balun design to transform single ended signal to differential signals in Bluetooth applications. This BALF-2690-02D3 has been customized for STLC2690 Bluetooth transceiver with less than 1.2 dB insertion losses in the bandwidth (2400 MHz-2500 MHz).

The BALF-2690-02D3 has been designed using STMicroelectronics IPD (integrated passive device) technology on non-conductive glass substrate which optimize RF performances.

Figure 1. Device configuration (top view)

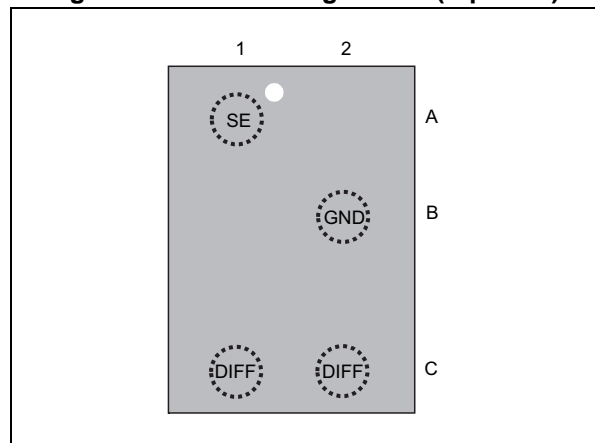
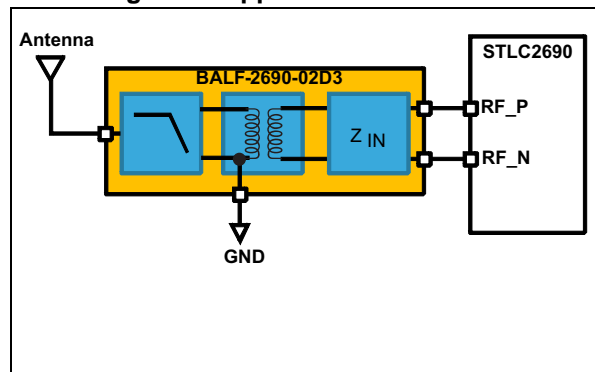

Figure 2. Application schematic



1 Characteristics

Table 1. Absolute maximum ratings (limiting values)

Symbol	Parameter	Value			Unit
		Min.	Typ.	Max.	
P_{IN}	Input power RFIN		10	13	dBm
V_{ESD}	ESD rating, human body model (JESD22-A114-C) all I/O one at a time while others connected to GND	2000			V
	ESD rating, machine model, all I/O	200			
T_{OP}	Operating temperature range	-40		+85	°C

Table 2. Impedances ($T_{amb} = 25\text{ °C}$)

Symbol	Parameter	Value			Unit
		Min.	Typ.	Max.	
Z_{DIFF}	Nominal differential impedance		matched to STLC2690		Ω
Z_{SE}	Nominal single-ended impedance		50		

Table 3. RF performance ($T_{amb} = 25\text{ °C}$)

Symbol	Parameter	Test condition	Value			Unit
			Min.	Typ.	Max.	
f	Frequency range (bandwidth)		2400		2500	MHz
I_L	Insertion loss in bandwidth			+1.2		dB
R_{L_SE}	Return loss in bandwidth		15	21		dB
Φ_{imb}	Output phase imbalance (single ended)		-10		+10	°
A_{imb}	Output amplitude imbalance		-1	0.5	1	dB
CMRR	Common mode rejection (S_{SC12})		20			dB
Att_{2f_0}	2nd harmonic S21 attenuation	4800-5000 MHz	31			dB
Att_{3f_0}	3rd harmonic S21 attenuation	7200-7500 MHz	36			

1.1 Measurements

Figure 3. Return loss ($T_{amb} = 25\text{ }^{\circ}\text{C}$)

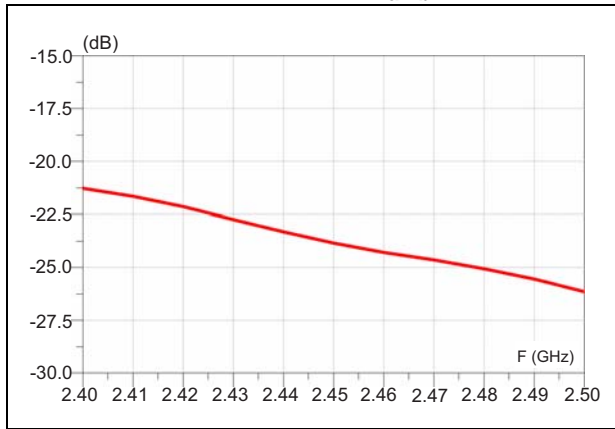

Figure 4. Insertion loss ($T_{amb} = 25\text{ }^{\circ}\text{C}$)

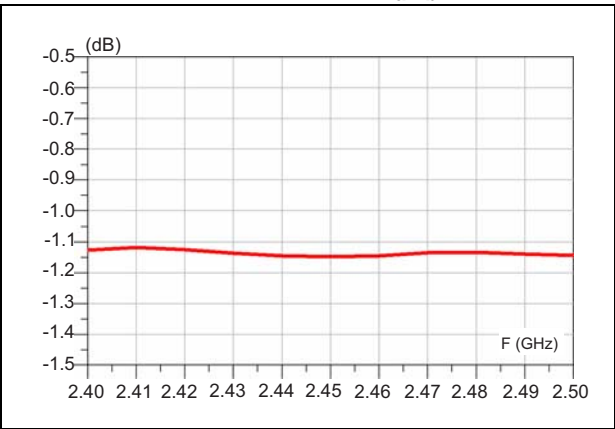

Figure 5. Phase imbalance ($T_{amb} = 25\text{ }^{\circ}\text{C}$)

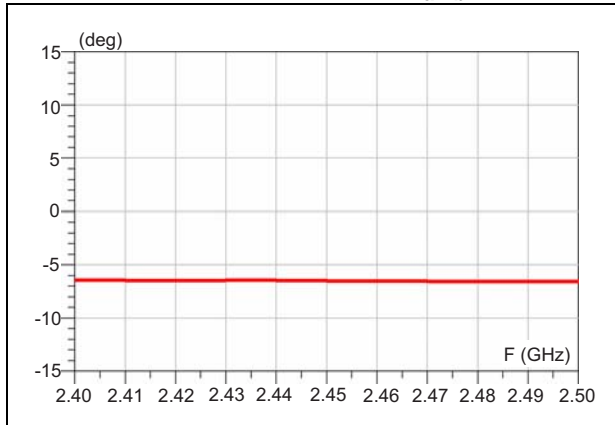

Figure 6. Amplitude imbalance ($T_{amb} = 25\text{ }^{\circ}\text{C}$)

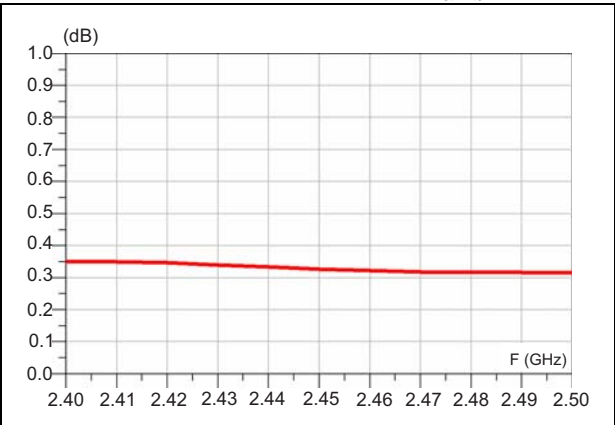

Figure 7. Transmission: 2nd harmonic (dB) ($T_{amb} = 25\text{ }^{\circ}\text{C}$)

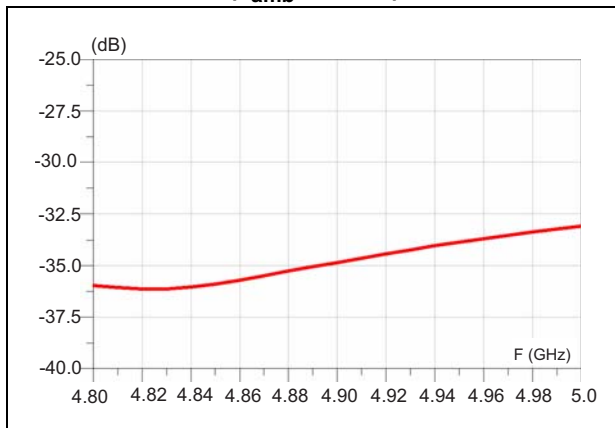

Figure 8. Transmission: 3rd harmonic (dB) ($T_{amb} = 25\text{ }^{\circ}\text{C}$)

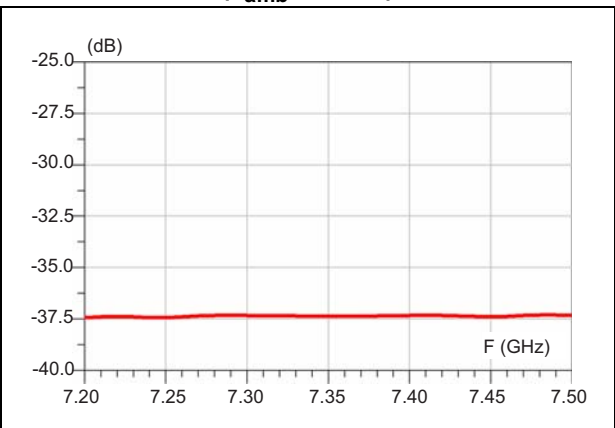
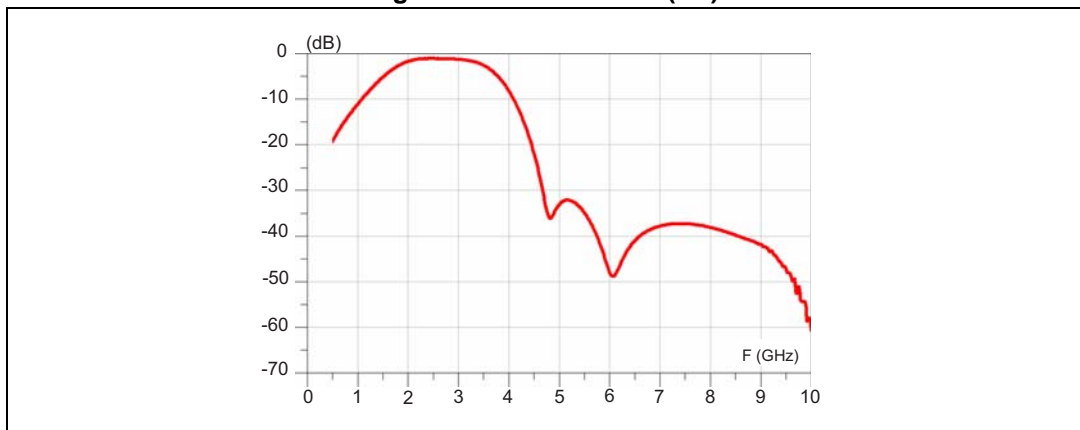

Figure 9. Transmission (dB)



2 Package information

- Epoxy meets UL94, V0
- Lead-free package

In order to meet environmental requirements, ST offers these devices in different grades of ECOPACK® packages, depending on their level of environmental compliance. ECOPACK® specifications, grade definitions and product status are available at: www.st.com. ECOPACK® is an ST trademark.

Figure 10. Package dimensions

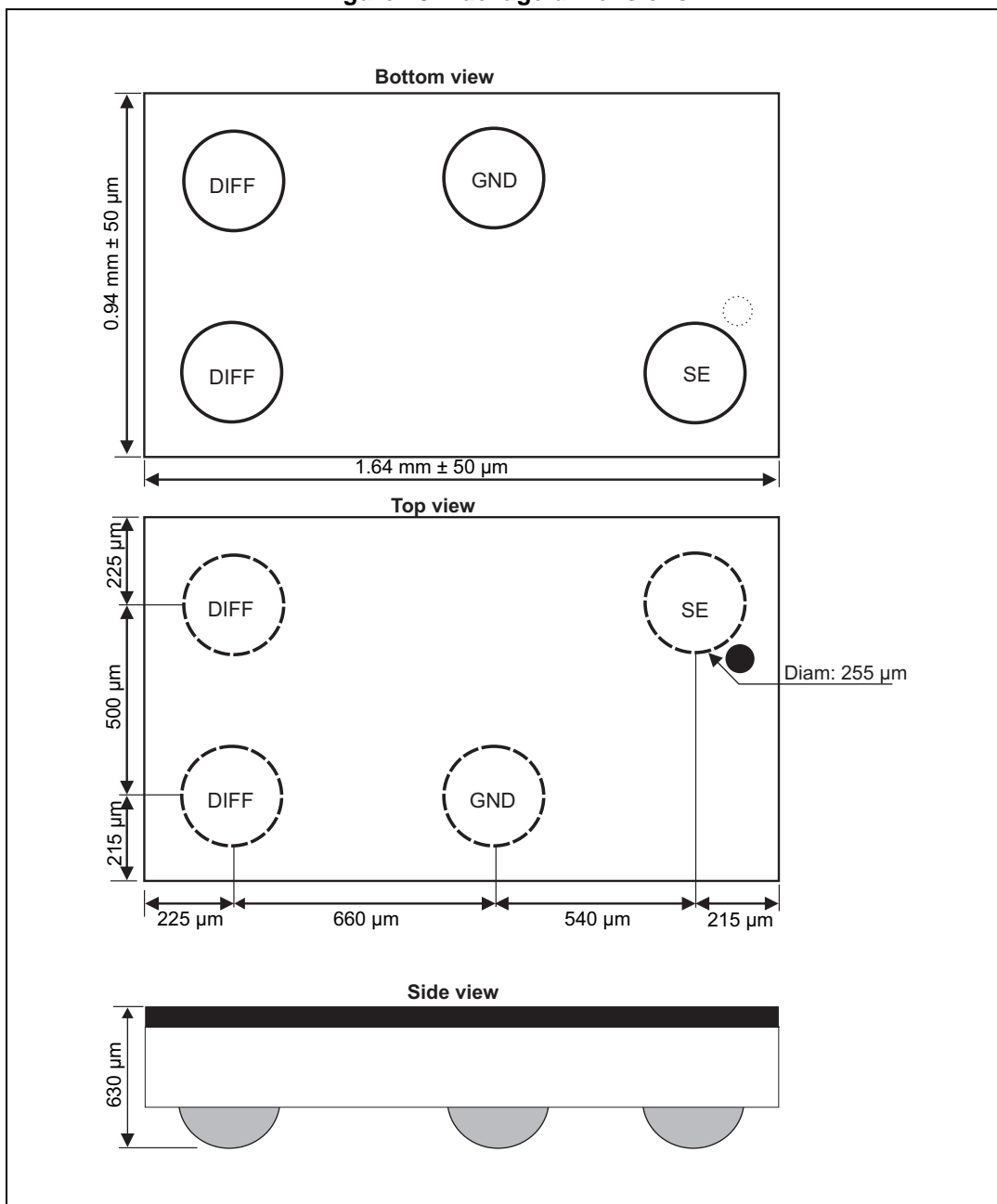

Figure 11. Footprint - non solder mask defined

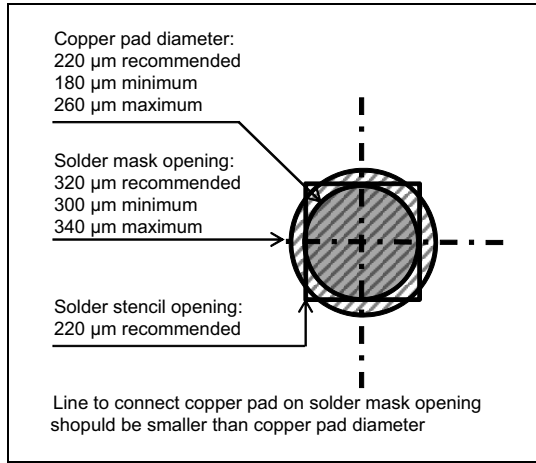

Figure 12. Footprint - solder mask defined

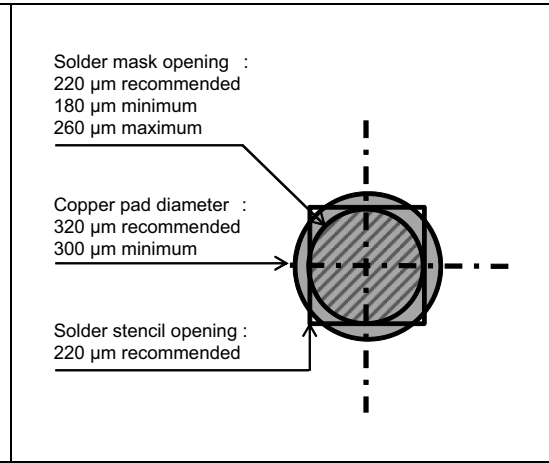

Figure 13. Marking

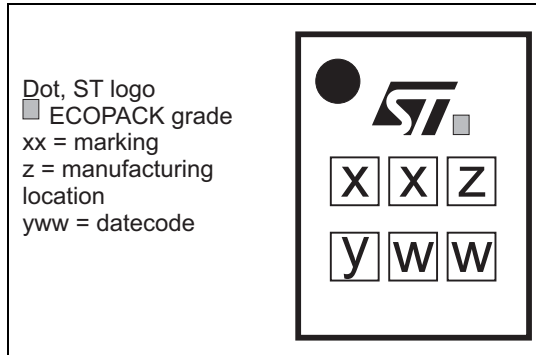

Figure 14. Recommended land pattern

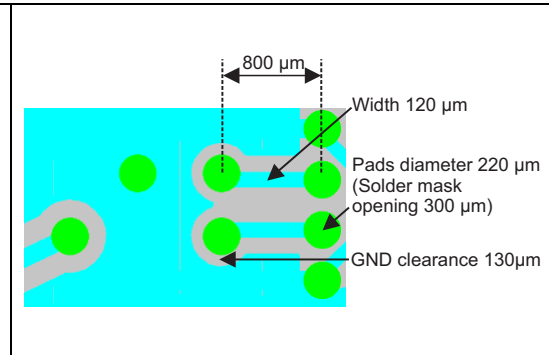
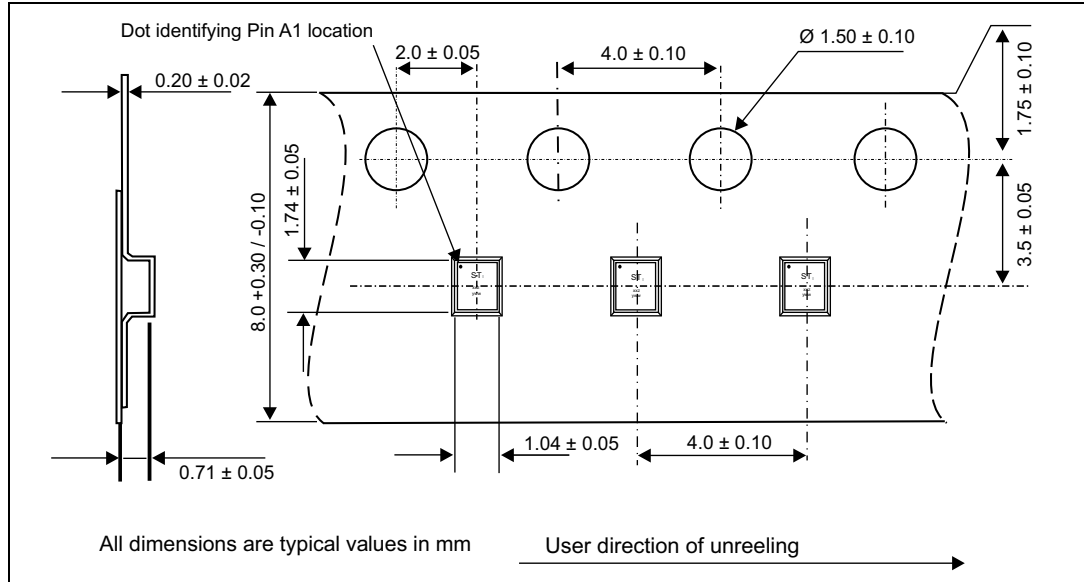

Figure 15. Flip Chip tape and reel specifications



Note: More information is available in the STMicroelectronics application notes: AN2348 Flip-Chip: "Package description and recommendations for use"

3 Ordering information

Table 4. Ordering information

Order code	Marking	Weight	Base Qty	Delivery mode
BALF-2690-02D3	SP	1.81 mg	5000	Tape and Reel

4 Revision history

Table 5. Document revision history

Date	Revision	Changes
27-Sep-2013	1	Initial release
19-Dec-2013	2	Added product weight in Table 4 and updated Table 1 .
19-Nov-2014	3	Added tape and reel dimensions.

IMPORTANT NOTICE – PLEASE READ CAREFULLY

STMicroelectronics NV and its subsidiaries ("ST") reserve the right to make changes, corrections, enhancements, modifications, and improvements to ST products and/or to this document at any time without notice. Purchasers should obtain the latest relevant information on ST products before placing orders. ST products are sold pursuant to ST's terms and conditions of sale in place at the time of order acknowledgement.

Purchasers are solely responsible for the choice, selection, and use of ST products and ST assumes no liability for application assistance or the design of Purchasers' products.

No license, express or implied, to any intellectual property right is granted by ST herein.

Resale of ST products with provisions different from the information set forth herein shall void any warranty granted by ST for such product.

ST and the ST logo are trademarks of ST. All other product or service names are the property of their respective owners.

Information in this document supersedes and replaces information previously supplied in any prior versions of this document.

© 2014 STMicroelectronics – All rights reserved