

4855452 INTERNATIONAL RECTIFIER

55C 04843 D

Data Sheet No. PD-3.176

T-25-15

INTERNATIONAL RECTIFIER 

**10RIF, 16RIF, 20RIF SERIES**  
**16A, 25A, 32A RMS Medium Power**  
**Fast Turn-off Thyristors**

Major Ratings and Characteristics

	10RIF	16RIF	20RIF	Units
$I_T(AV)$ @	10	16	20	A
$T_C$	85	85	85	°C
$I_{TSM}$	50Hz	100	200	A
	60Hz	105	209	A
$I^2t$	50Hz	50	200	A <sup>2</sup> s
	60Hz	46	183	A <sup>2</sup> s
$I^2\sqrt{t}$	707	2828	4412	A <sup>2</sup> √s
Max. $t_q$ range	10 to 40			μs
$V_{RRM}$ range	100 to 1200			V
$T_J$	-40 to 125			°C

Description/Features

The 10RIF, 16RIF and 20RIF series of fast turn-off thyristors are suitable for applications such as inverters, switch mode power supplies and choppers.

- Fully characterised data.
- High surge capability.
- Available up to 1200V  $V_{DRM}$ ,  $V_{RRM}$ .
- Turn-off time as short as 10μs.



CASE STYLES AND DIMENSIONS

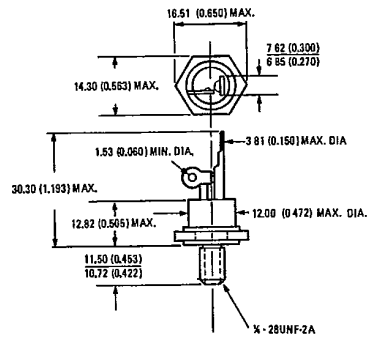
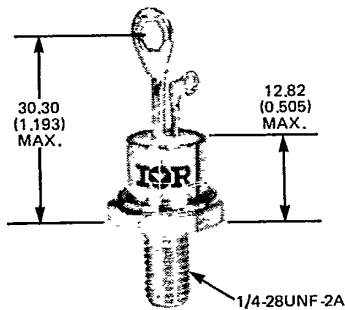

Conforms to JEDEC outline TO-208AA (TO-48)  
 Dimensions in Millimetres and (Inches)

4855452 INTERNATIONAL RECTIFIER  
10RIF, 16RIF, 20RIF Series

55C 04844 D  
INTERNATIONAL RECTIFIER 

T-25-15

Voltage ratings

Part number	V <sub>RRM</sub> , max. repetitive peak reverse voltage V <sub>g</sub> ≤ 0	V <sub>RSM</sub> , max. non-repetitive peak reverse voltage	V <sub>DRM</sub> , max. repetitive peak off-state voltage, gate open circuit	I <sub>RM</sub> , I <sub>DM</sub> , max. peak reverse and off-state leakage current at V <sub>RRM</sub> , V <sub>DRM</sub> , T <sub>J</sub> = 125°C, gate open circuit
				mA
10RIF10W..	100	150	100	10
10RIF20W..	200	300	200	10
10RIF40W..	400	500	400	10
10RIF60W..	600	700	600	10
10RIF80W..	800	900	800	10
10RIF100W..	1000	1100	1000	10
10RIF120W..	1200	1300	1200	10

Forward Conduction

	10RIF	16RIF	20RIF	Units	Conditions	
					180° conduction, half-sine wave, T <sub>C</sub> = 85°C	
I <sub>T(AV)</sub> Max. average on-state current	10	16	20	A		
I <sub>T(RMS)</sub> Max. continuous RMS on-state current	16	25	32	A		
I <sub>TSM</sub> Max. peak, one cycle non-repetitive on-state current	100	200	250	A	t = 10ms	100% V <sub>RRM</sub> reapplied Sinusoidal half-wave, T <sub>J</sub> = 125°C
	105	209	261	A	t = 8.3ms	
	119	238	297	A	t = 10ms	
	124	249	311	A	t = 8.3ms	
I <sup>2</sup> <sub>t</sub> Max. I <sup>2</sup> <sub>t</sub> capability for fusing	50	200	312	A <sup>2</sup> <sub>s</sub>	t = 10ms	100% V <sub>RRM</sub> reapplied Initial T <sub>J</sub> = 125°C
	46	183	285	A <sup>2</sup> <sub>s</sub>	t = 8.3ms	
	71	283	441	A <sup>2</sup> <sub>s</sub>	t = 10ms	
	65	268	403	A <sup>2</sup> <sub>s</sub>	t = 8.3ms	
I <sup>2</sup> √t Max. I <sup>2</sup> √t capability, for individual device fusing	707	2828	4412	A <sup>2</sup> √s	t = 0.1 – 10ms, no voltage reapplied	
					T <sub>J</sub> = 25°C, 180° conduction, I <sub>TM</sub> = π × I <sub>T(AV)</sub>	
V <sub>TM</sub> Max. peak on-state voltage	2.0	2.0	2.0	V	T <sub>J</sub> = 125°C, V <sub>DM</sub> = 0.67 rated V <sub>DRM</sub> , I <sub>TM</sub> = 2 × rated di/dt, I <sub>g</sub> = 250mA, t <sub>r</sub> ≤ 0.5 μs. For repetitive value use 40% non-repetitive. Per JEDEC Standard RS-397, 5.2.2.6.	
di/dt Max. non-repetitive rate-of-rise of turned on current	200			A/μs	600V	
	180			A/μs	800V	
	160			A/μs	1000V	
	150			A/μs	1200V	
V <sub>T(TO)</sub> Max. value of threshold voltage	1.310	1.240	1.180	V	T <sub>J</sub> = 125°C	
r <sub>T</sub> Max. value of on-state slope resistance	15.89	13.63	11.84	mΩ		
I <sub>H</sub> Max. holding current	100			mA	T <sub>J</sub> = 25°C, anode supply = 6V, resistive load, gate open circuited	
I <sub>L</sub> Max. latching current	200			mA	T <sub>J</sub> = 25°C, anode supply = 6V, resistive load	

Triggering

P <sub>GM</sub> Max. peak gate power	8	W	
P <sub>G(AV)</sub> Max. average gate power	2.0	W	
I <sub>GM</sub> Max. peak gate current	1.5	A	
-V <sub>GM</sub> Max. peak negative gate voltage	10	V	
V <sub>GT</sub> Max. gate voltage required to trigger	3	V	T <sub>J</sub> = -40°C
	2	V	T <sub>J</sub> = 25°C
	1	V	T <sub>J</sub> = 125°C
I <sub>GT</sub> Max. gate current required to trigger	90	mA	T <sub>J</sub> = -40°C
	60	mA	T <sub>J</sub> = 25°C
	35	mA	T <sub>J</sub> = 125°C

4855452 INTERNATIONAL RECTIFIER

55C 04845 D



10RIF, 16RIF, 20RIF Series

T-25-15

Triggering (continued)

V <sub>GD</sub>	Max. gate voltage that will not trigger	0.2	V	T <sub>J</sub> = 125°C, rated V <sub>DRM</sub> applied
I <sub>GD</sub>	Max. gate current that will not trigger	2.0	mA	T <sub>J</sub> = 125°C, rated V <sub>DRM</sub> applied

Switching

t <sub>d</sub> + t <sub>r</sub>	Typical turn-on time	0.9	μs	T <sub>J</sub> = 25°C, V <sub>D</sub> = 0.8 V <sub>DRM</sub> , I <sub>TM</sub> = I <sub>T(AV)</sub> , resistive load I <sub>g</sub> = 250mA, t <sub>r</sub> < 0.5 μs, t <sub>p</sub> > 6 μs
t <sub>q</sub>	Max. turn-off time	see separate table		See Page A-51.

Blocking

dv/dt	Min. critical rate-of-rise of off-state voltage	500	V/μs	T <sub>J</sub> = 125°C, exponential to 0.67 rated V <sub>DRM</sub> , gate open circuited
-------	---	-----	------	--

THERMAL AND MECHANICAL SPECIFICATIONS

		10RIF	16RIF	20RIF	Units	Conditions
T <sub>J</sub>	Junction operating temperature range	-40 to 125			°C	
T <sub>stg</sub>	Storage temperature range	-40 to 150			°C	
R <sub>thJC</sub>	Max. thermal resistance, junction-to-case	1.95	1.15	0.92	K/W	DC Operation
R <sub>thCS</sub>	Max. thermal resistance, case-to-heatsink	0.35			K/W	Mounting surface flat, smooth and greased.
T	Mounting torque ± 10% to nut	20(27.5)			lbf.in	Lubricated threads
		0.23(0.32)			kgf.m	
		2.3(3.1)			Nm	(Non-lubricated threads)
	to device	25			lbf.in	Lubricated threads
		0.29			kgf.m	
		2.8			Nm	
wt	Approximate weight	0.49			oz	
		14			g	
	Case style	TO-208AA (TO-48)				JEDEC



MAXIMUM TURN-OFF TIME TABLE

t <sub>q</sub>	Units	t <sub>q</sub> code	max. V <sub>DRM</sub> , V <sub>RRM</sub>	Conditions
10	μs	10	600V	T <sub>J</sub> = 125°C, I <sub>TM</sub> = rated I <sub>T(AV)</sub> for > 200 μs, -di/dt = 10 A/μs, V <sub>R</sub> = 100V, reapplied dv/dt = 200 V/μs exponential to 0.67 V <sub>DRM</sub>
15	μs	15	600V	
20	μs	20	1000V	
40	μs	40	1200V	

4855452 INTERNATIONAL RECTIFIER



55C 04846 D

10RIF, 16RIF, 20RIF Series

T-25-15

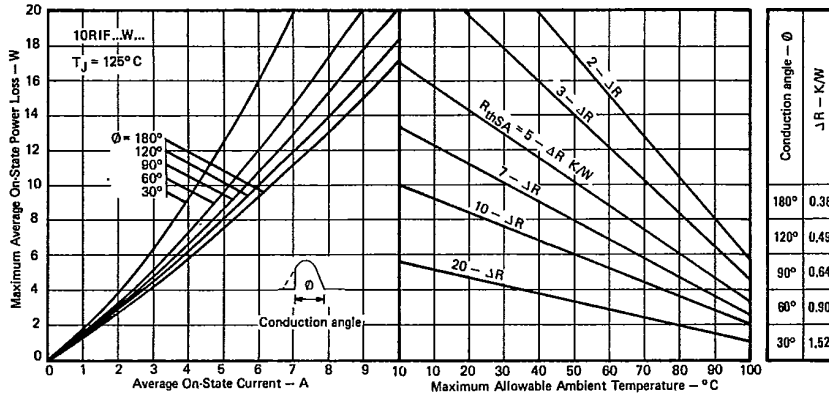

Fig. 1 — Current Ratings (Sinusoidal Waveforms, 50–400 Hz), 10RIF Series.

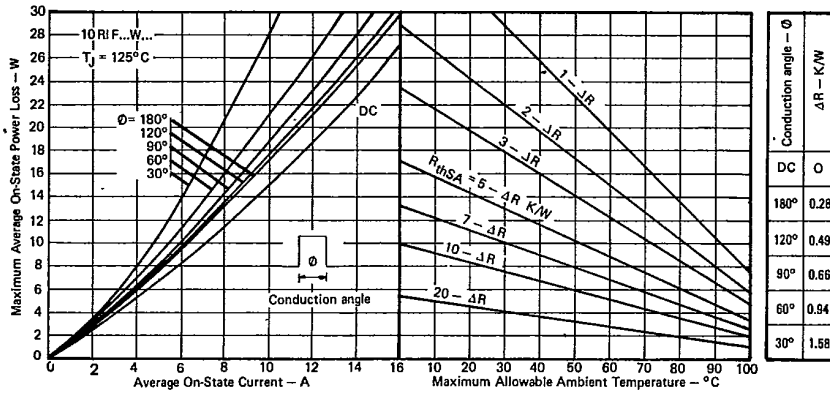

Fig. 2 — Current Ratings (Sinusoidal Waveforms, 50–400 Hz), 10RIF Series.



4855452 INTERNATIONAL RECTIFIER  
10RIF, 16RIF, 20RIF Series

55C 04847 D  
INTERNATIONAL RECTIFIER **IR**

T-25-15

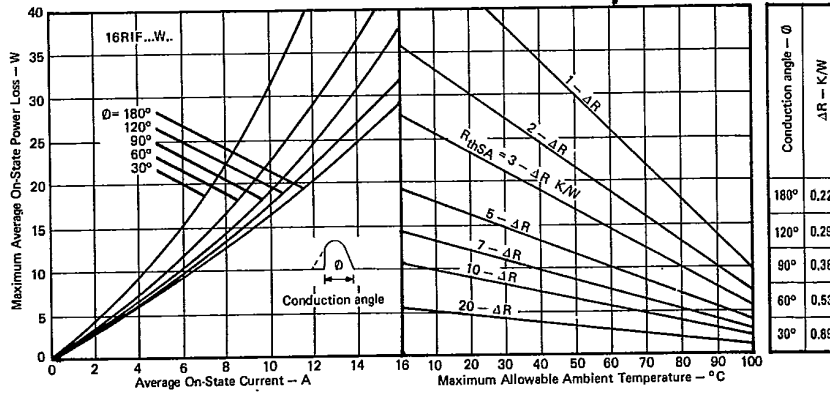

Fig. 3 - Current Ratings (Sinusoidal Waveforms, 50-400 Hz), 16RIF Series.

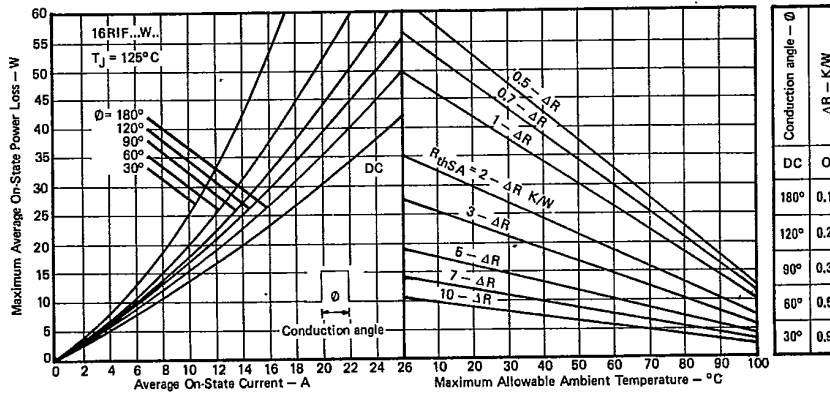

Fig. 4 - Current Ratings (Rectangular Waveforms, 50-400 Hz), 16RIF Series.

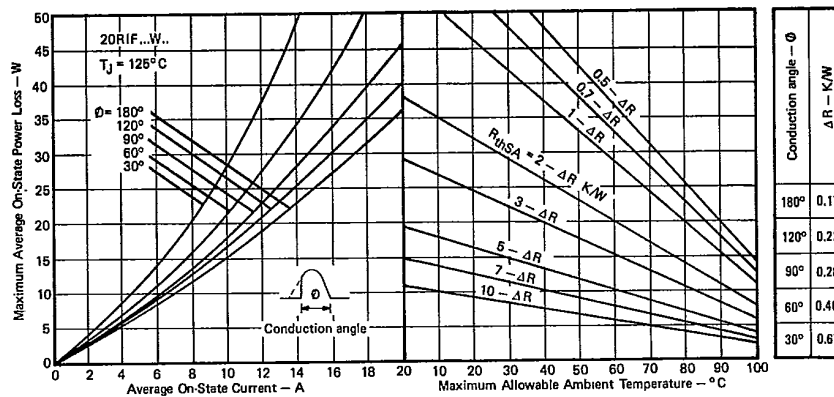

Fig. 5 - Current Ratings (Sinusoidal Waveforms, 50-400 Hz), 20RIF Series.

4855452 INTERNATIONAL RECTIFIER

55C 04848 D



10RIF, 16RIF, 20RIF Series

T-25-15

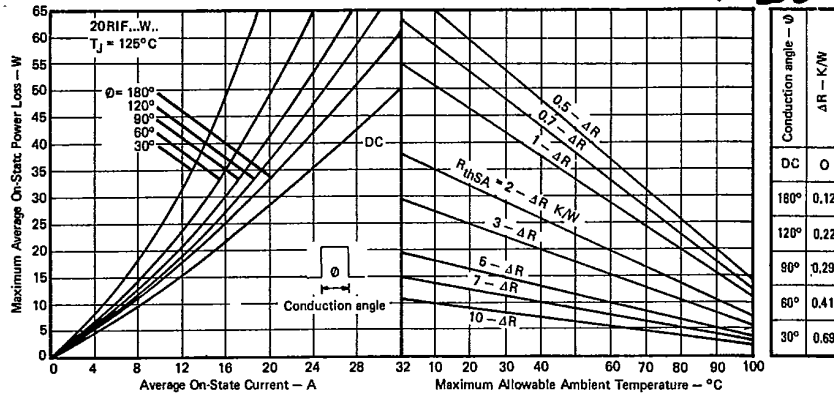

Fig. 6 - Current Ratings (Rectangular Waveforms, 50-400 Hz), 20RIF Series.

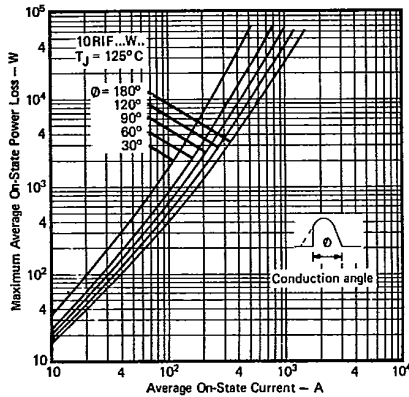

Fig. 7 - High Level Power Loss Characteristics - (Sinusoidal Current Waveform), 10RIF Series.

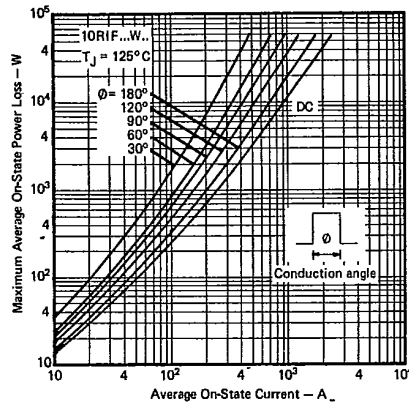

Fig. 8 - High Level Power Loss Characteristics - (Rectangular Current Waveform), 10RIF Series.

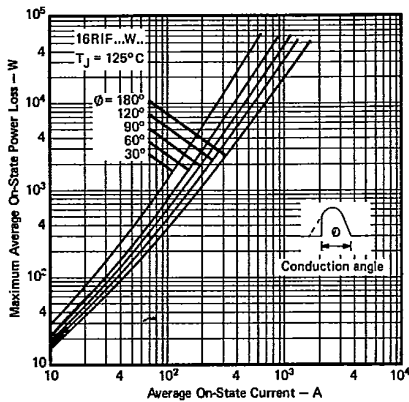

Fig. 9 - High Level Power Loss Characteristics - (Sinusoidal Current Waveform), 16RIF Series.

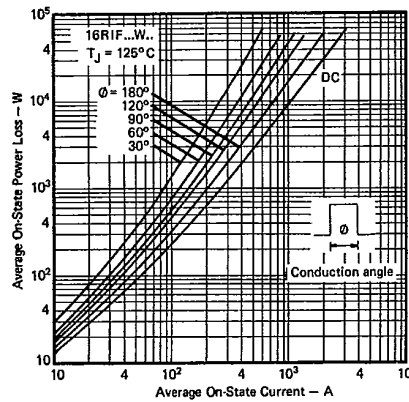

Fig. 10 - High Level Power Loss Characteristics - (Rectangular Current Waveform), 16RIF Series.

A

4855452 INTERNATIONAL RECTIFIER  
10RIF, 16RIF, 20RIF Series

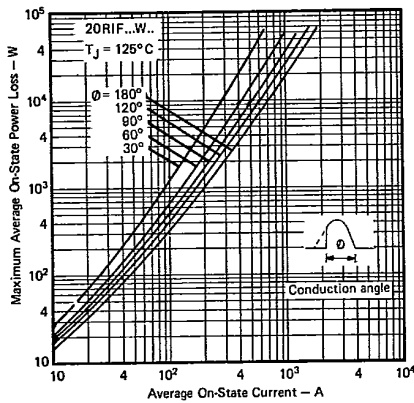

Fig. 11 - High Level Power Loss Characteristics - (Sinusoidal Current Waveform), 20RIF Series.

55C 04849 D  
INTERNATIONAL RECTIFIER IOR

T-25-15

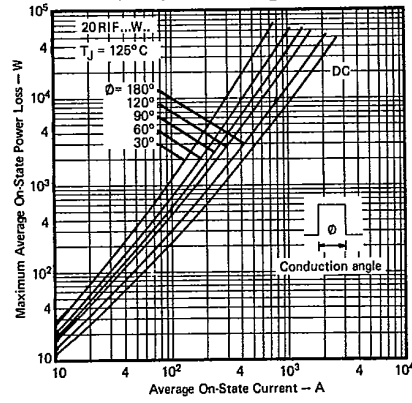

Fig. 12 - High Level Power Loss Characteristics - (Rectangular Current Waveform), 20RIF Series.

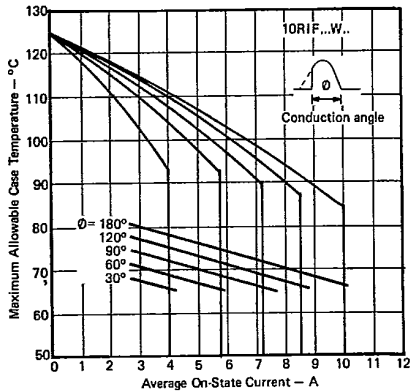

Fig. 13 - Case Temperature Ratings - (Sinusoidal Current Waveform), 10RIF Series.

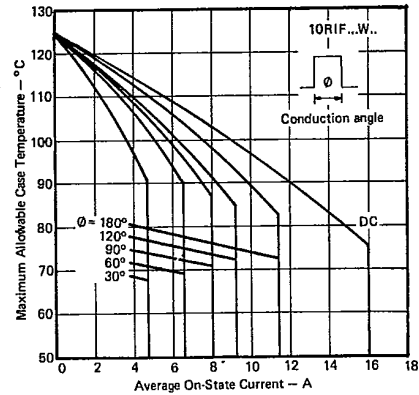

Fig. 14 - Case Temperature Ratings - (Rectangular Current Waveform), 10RIF Series.

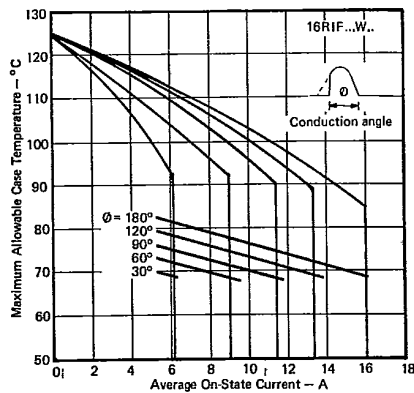

Fig. 15 - Case Temperature Ratings - (Sinusoidal Current Waveform), 16RIF Series.

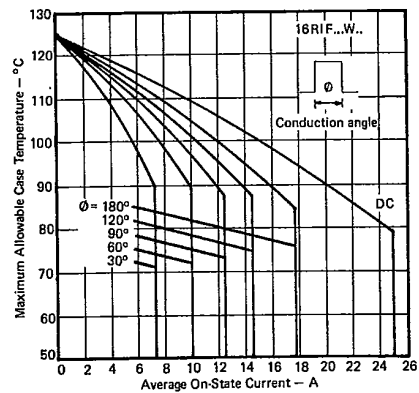

Fig. 16 - Case Temperature Ratings - (Rectangular Current Waveform), 16RIF Series.

4855452 INTERNATIONAL RECTIFIER

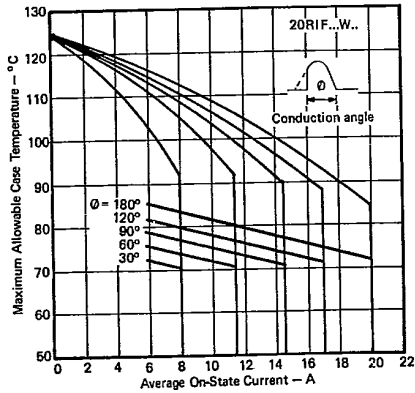

Fig. 17 - Case Temperature Ratings - (Sinusoidal Current Waveform), 20RIF Series.

55C 04850 D

10RIF, 16RIF, 20RIF Series

T-25-15

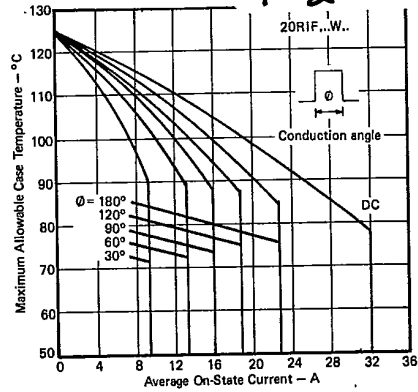

Fig. 18 - Case Temperature Ratings - (Rectangular Current Waveform), 20RIF Series.

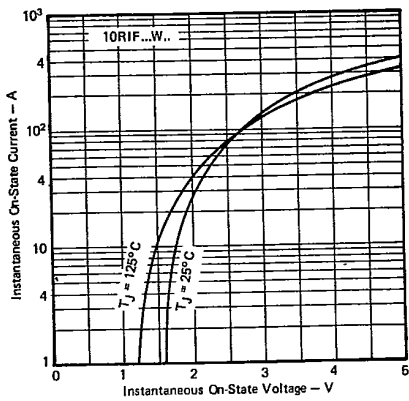

Fig. 19 - On-State Characteristics, 10RIF Series.

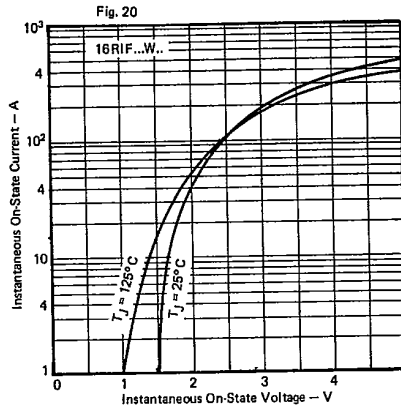

Fig. 20 - On-State Characteristics, 16RIF Series.

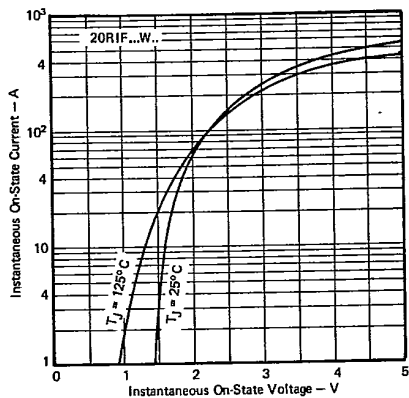

Fig. 21 - On-State Characteristics, 20RIF Series.

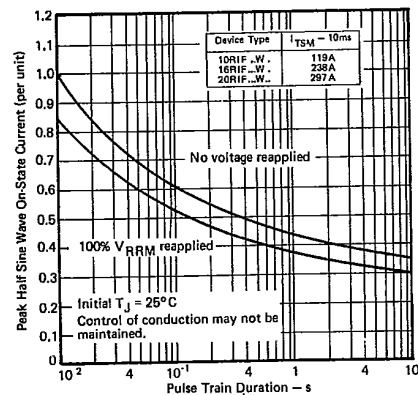

Fig. 22 - Non-Repetitive Surge Ratings, All Series.

A



4855452 INTERNATIONAL RECTIFIER

55C 04851 D

10RIF, 16RIF, 20RIF Series

INTERNATIONAL RECTIFIER **IR**

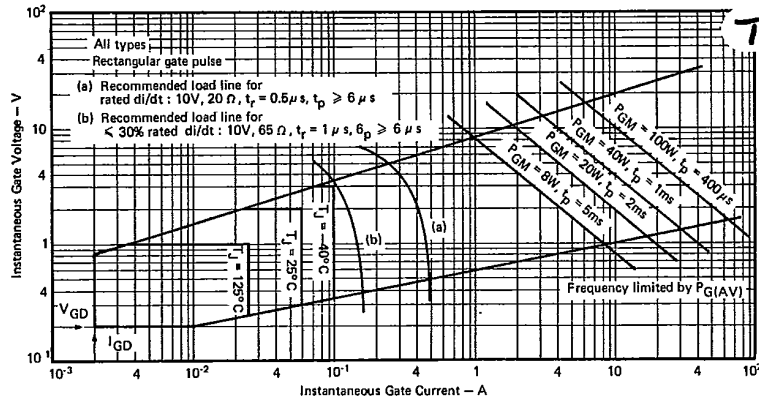

Fig. 23 - Gate Characteristics, All Series.

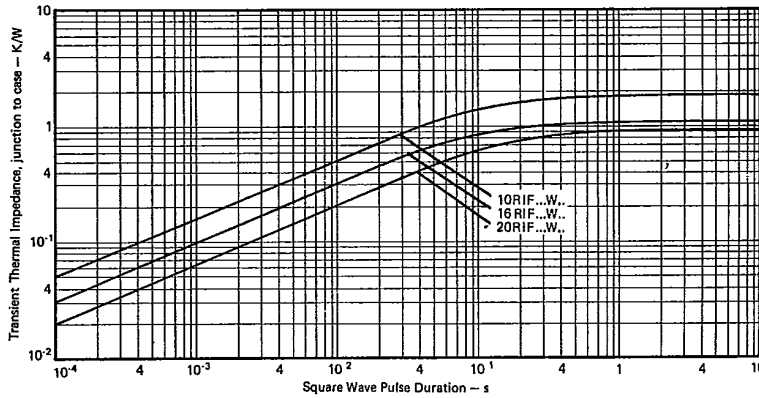

Fig. 24 - Transient Thermal Impedance Characteristics, All Series.

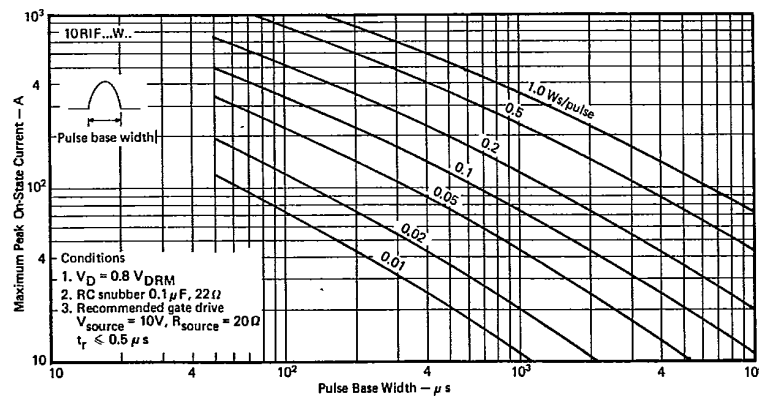

Fig. 25 - Energy Loss per Pulse Characteristics - (Sinusoidal Current Waveform), 10RIF Series.

4855452 INTERNATIONAL RECTIFIER

55C 04852 D  
10RIF, 16RIF, 20RIF Series



T-25-15

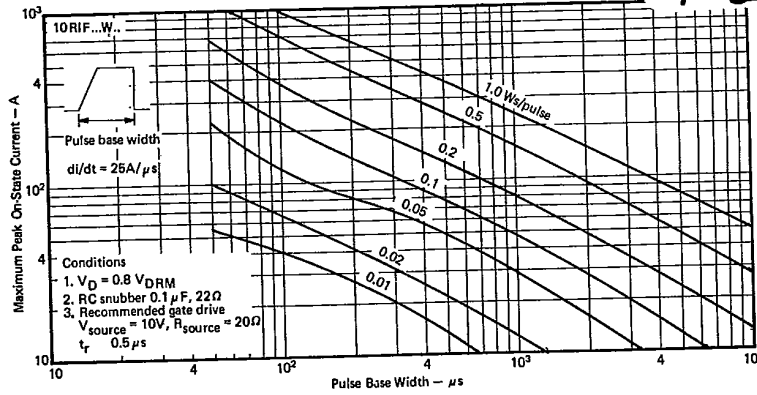

Fig. 26 - Energy Loss per Pulse Characteristics - (Trapezoidal Current Waveform)  $di/dt = 25 A/\mu s$ , 10RIF Series.

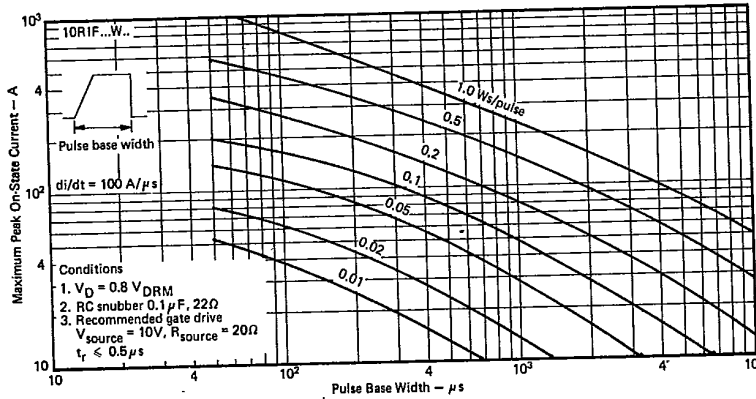

Fig. 27 - Energy Loss per Pulse Characteristics - (Trapezoidal Current Waveform)  $di/dt = 100 A/\mu s$ , 10RIF Series.

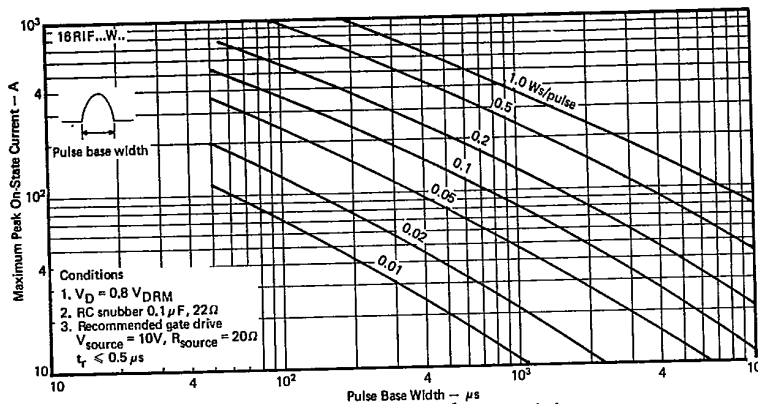

Fig. 28 - Energy Loss per Pulse Characteristics - (Sinusoidal Current Waveform), 16RIF Series.

A

4855452 INTERNATIONAL RECTIFIER  
10RIF, 16RIF, 20RIF Series

55C 04853 D  
INTERNATIONAL RECTIFIER **IR**

T-25-15

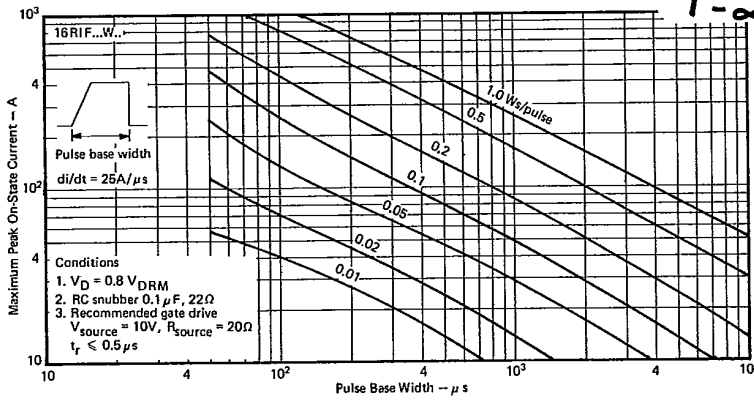

Fig. 29 - Energy Loss per Pulse Characteristics -  
(Trapezoidal Current Waveform)  $di/dt = 25 A/\mu s$ ,  
16RIF Series.

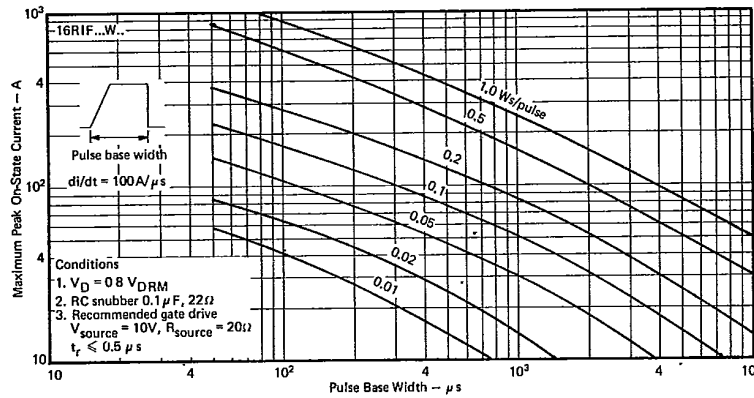

Fig. 30 - Energy Loss per Pulse Characteristics -  
(Trapezoidal Current Waveform)  $di/dt = 100 A/\mu s$ ,  
16RIF Series.

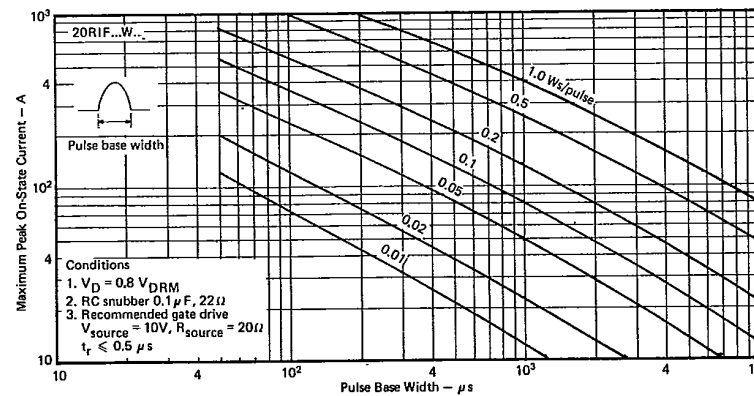

Fig. 31 - Energy Loss per Pulse Characteristics -  
(Sinusoidal Current Waveform), 20RIF Series.

4855452 INTERNATIONAL RECTIFIER



55C 04854 D

10RIF, 16RIF, 20RIF Series

T-25-15

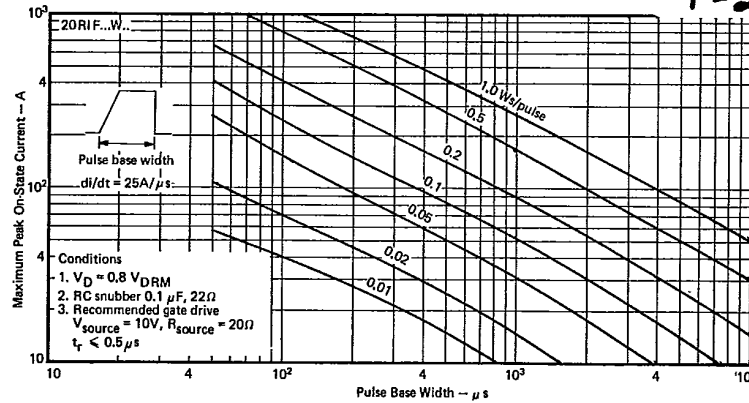

Fig. 32 - Energy Loss per Pulse Characteristics - (Trapezoidal Current Waveform)  $di/dt = 25 A/\mu s$ , 20RIF Series.

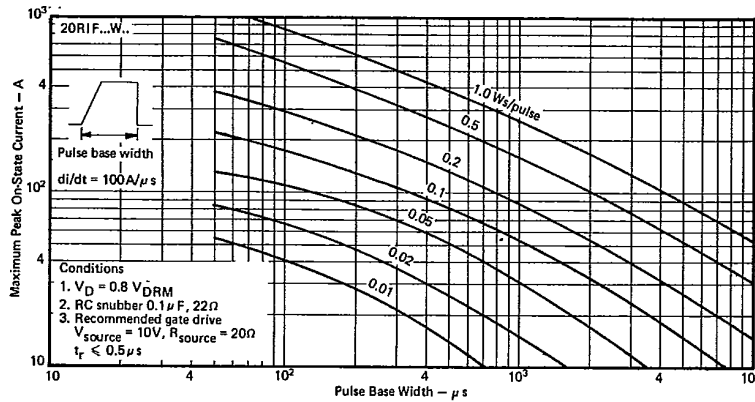

Fig. 33 - Energy Loss per Pulse Characteristics - (Trapezoidal Current Waveform)  $di/dt = 100 A/\mu s$ , 20RIF Series.

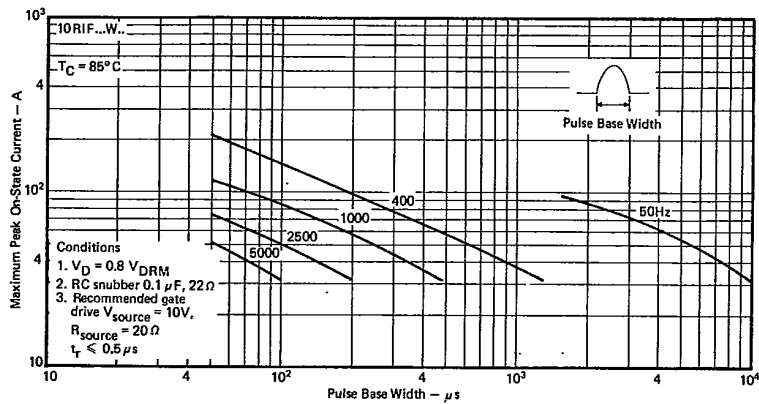

Fig. 34 - Peak On-State Current Vs. Pulse Width - (Sinusoidal Current Waveform), 10RIF Series.

A

4855452 INTERNATIONAL RECTIFIER

55C 04855 D

10RIF, 16RIF, 20RIF Series

INTERNATIONAL RECTIFIER **IOR**

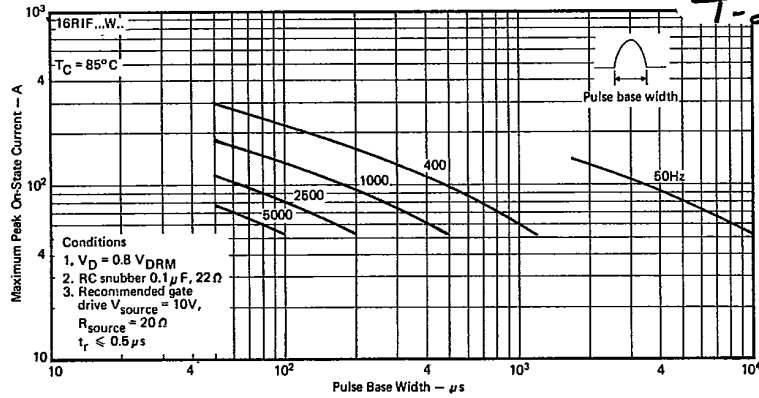

Fig. 35 - Peak On-State Current Vs. Pulse Width - (Sinusoidal Current Waveform), 16RIF Series.

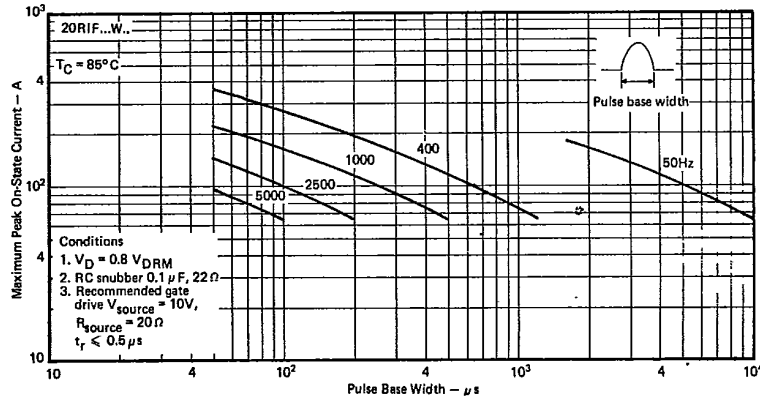

Fig. 36 - Peak On-State Current Vs. Pulse Width - (Sinusoidal Current Waveform), 20RIF Series.

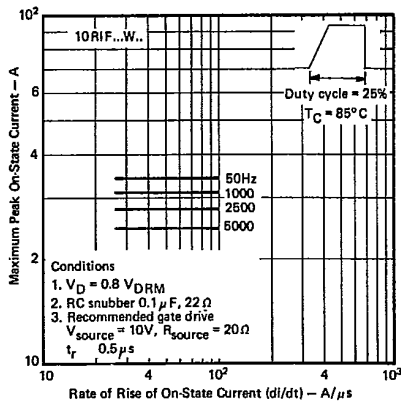

Fig. 37 - Peak On-State Current Vs. di/dt (Trapezoidal Current Waveform) Duty Cycle = 25%, 10RIF Series.

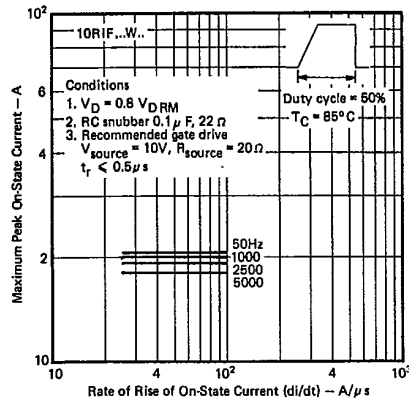

Fig. 38 - Peak On-State Current Vs. di/dt (Trapezoidal Current Waveform) Duty Cycle = 50%, 10RIF Series.

4855452 INTERNATIONAL RECTIFIER



55C 04856 D

10RIF, 16RIF, 20RIF Series

T-25-15

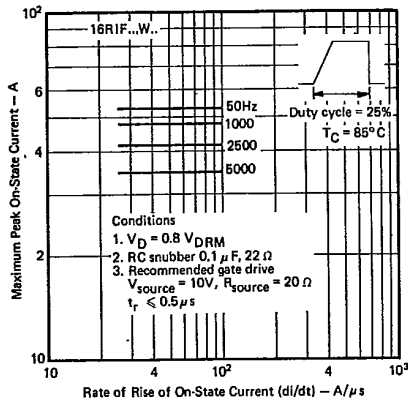

Fig. 39 - Peak On-State Current Vs. di/dt (Trapezoidal Current Waveform) Duty Cycle = 25%, 16RIF Series.

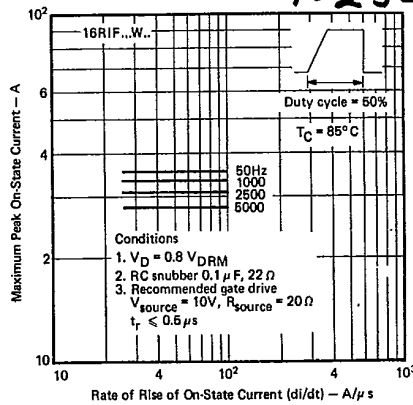

Fig. 40 - Peak On-State Current Vs. di/dt (Trapezoidal Current Waveform) Duty Cycle = 50%, 16RIF Series.

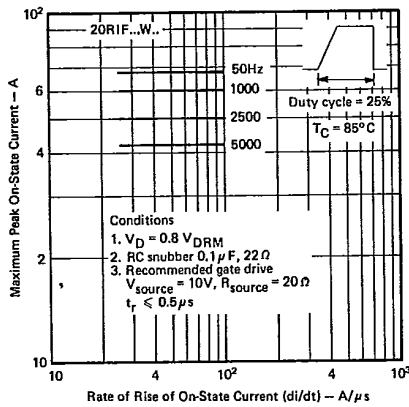

Fig. 41 - Peak On-State Current Vs. di/dt (Trapezoidal Current Waveform) Duty Cycle = 25%, 20RIF Series.

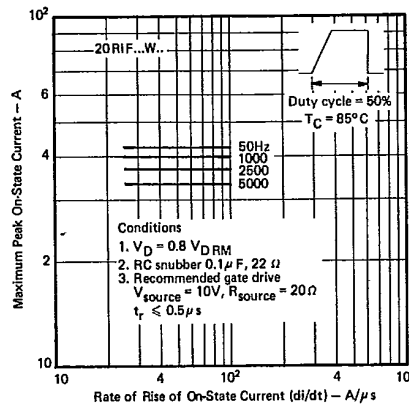

Fig. 42 - Peak On-State Current Vs. di/dt (Trapezoidal Current Waveform) Duty Cycle = 50%, 20RIF Series.

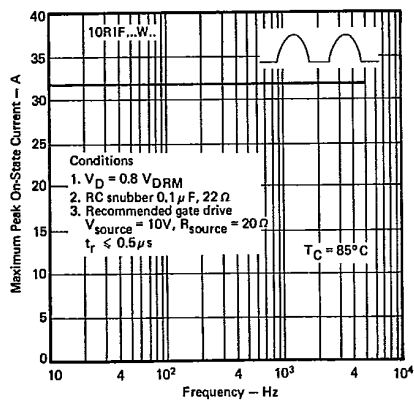

Fig. 43 - Peak On-State Current Vs. Frequency (Sinusoidal Current Waveform), 10RIF Series.

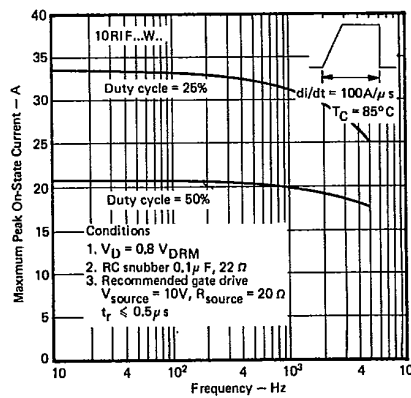

Fig. 44 - Peak On-State Current Vs. Frequency (Trapezoidal Current Waveform), 10RIF Series.

A

4855452 INTERNATIONAL RECTIFIER

55C 04857 D

10RIF, 16RIF, 20RIF Series

INTERNATIONAL RECTIFIER 

T-25-15

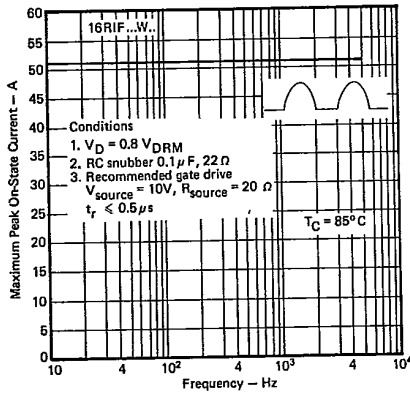

Fig. 45 — Peak On-State Current Vs. Frequency (Sinusoidal Current Waveform), 16RIF Series.

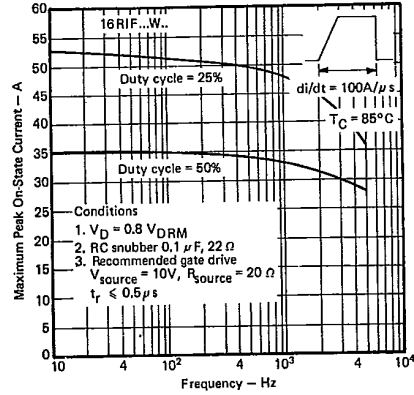

Fig. 46 — Peak On-State Current Vs. Frequency (Trapezoidal Current Waveform), 16RIF Series.

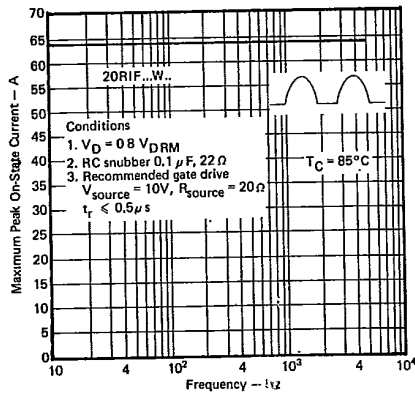

Fig. 47 — Peak On-State Current Vs. Frequency (Sinusoidal Current Waveform), 20RIF Series.

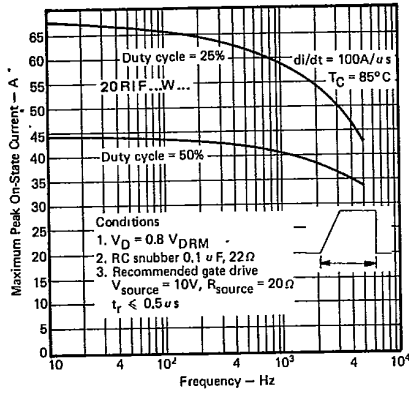

Fig. 48 — Peak On-State Current Vs. Frequency (Trapezoidal Current Waveform), 20RIF Series.