

### Features

- On-state rms current,  $I_{T(RMS)}$  25 A
- Repetitive peak off-state voltage,  $V_{DRM}/V_{RRM}$  600 to 1200 V
- Triggering gate current,  $I_{GT}$  40 mA
- Insulated package TO-220AB ins
  - Insulating voltage 2500 V rms
  - UL1557 certified (file ref. E81734)

### Description

These standard 25 A SCRs are suitable for general purpose applications.

Using clip assembly technology, they provide a superior performance in surge current capabilities.

TXN625RG is packaged in TO-220AB ins.

Table 1. Device summary

| Order code     | Voltage $V_{DRM}/V_{RRM}$ |       |        | Sensitivity<br>$I_{GT}$ | Package            |
|----------------|---------------------------|-------|--------|-------------------------|--------------------|
|                | 600 V                     | 800 V | 1200 V |                         |                    |
| TN2540-600G-TR | Y                         |       |        | 40 mA                   | D <sup>2</sup> PAK |
| TN2540-800G-TR |                           | Y     |        | 40 mA                   | D <sup>2</sup> PAK |
| TXN625RG       | Y                         |       |        | 40 mA                   | TO-220AB ins       |
| TYN625RG       | Y                         |       |        | 40 mA                   | TO-220AB           |
| TYN825RG       |                           | Y     |        | 40 mA                   | TO-220AB           |
| TYN1225RG      |                           |       | Y      | 40 mA                   | TO-220AB           |

# 1 Characteristics

**Table 2. Absolute ratings (limiting values)**

| Symbol             | Parameter   |                              | Value                 | Unit                           |                  |
|--------------------|---|------------------------------|-----------------------|--------------------------------|------------------|
| $I_{T(RMS)}$       | On-state rms current (180 °Conduction angle)  | TO-220AB, D <sup>2</sup> PAK | $T_c = 100\text{ °C}$ | 25                             | A                |
|                    |   | TO-220AB ins                 | $T_c = 83\text{ °C}$  |                                |                  |
| $I_{T(AV)}$        | Average on-state current (180 °Conduction angle)  |                              | $T_c = 100\text{ °C}$ | 16                             | A                |
| $I_{TSM}$          | Non repetitive surge peak on-state current  | $t_p = 8.3\text{ ms}$        | $T_j = 25\text{ °C}$  | 314                            | A                |
|                    |   | $t_p = 10\text{ ms}$         |                       | 300                            |                  |
| $I^2t$             | $I^2t$ Value for fusing   | $t_p = 10\text{ ms}$         | $T_j = 25\text{ °C}$  | 450                            | A <sup>2</sup> s |
| dI/dt              | Critical rate of rise of on-state current<br>$I_G = 2 \times I_{GT}$ , $t_r \leq 100\text{ ns}$ | F = 60 Hz                    | $T_j = 125\text{ °C}$ | 50                             | A/ $\mu$ s       |
| $I_{GM}$           | Peak gate current   | $t_p = 20\text{ }\mu$ s      | $T_j = 125\text{ °C}$ | 4                              | A                |
| $P_{G(AV)}$        | Average gate power dissipation  |                              | $T_j = 125\text{ °C}$ | 1                              | W                |
| $T_{stg}$<br>$T_j$ | Storage junction temperature range<br>Operating junction temperature range                      |                              |                       | - 40 to + 150<br>- 40 to + 125 | °C               |
| $V_{RGM}$          | Maximum peak reverse gate voltage   |                              |                       | 5                              | V                |

**Table 3. Electrical Characteristics ( $T_j = 25\text{ °C}$ , unless otherwise specified)**

| Symbol                 | Test conditions                                 |                       | Value | Unit |            |
|------------------------|---|-----------------------|-------|------|------------|
| $I_{GT}$               | $V_D = 12\text{ V}$ $R_L = 33\text{ }\Omega$    | MIN.                  | 4     | mA   |            |
|                        |   | MAX.                  | 40    |      |            |
| $V_{GT}$               |   | MAX.                  | 1.3   | V    |            |
| $V_{GD}$               | $V_D = V_{DRM}$ $R_L = 3.3\text{ k}\Omega$      | $T_j = 125\text{ °C}$ | MIN.  | 0.2  | V          |
| $I_H$                  | $I_T = 500\text{ mA}$ Gate open                 |                       | MAX.  | 50   | mA         |
| $I_L$                  | $I_G = 1.2 \times I_{GT}$                       |                       | MAX.  | 90   | mA         |
| dV/dt                  | $V_D = 67\% V_{DRM}$ Gate open                  | $T_j = 125\text{ °C}$ | MIN.  | 1500 | V/ $\mu$ s |
| $V_{TM}$               | $I_{TM} = 50\text{ A}$ $t_p = 380\text{ }\mu$ s | $T_j = 25\text{ °C}$  | MAX.  | 1.6  | V          |
| $V_{t0}$               | Threshold voltage                               | $T_j = 125\text{ °C}$ | MAX.  | 0.77 | V          |
| $R_d$                  | Dynamic resistance                              | $T_j = 125\text{ °C}$ | MAX.  | 14   | m $\Omega$ |
| $I_{DRM}$<br>$I_{RRM}$ | $V_{DRM} = V_{RRM}$                             | $T_j = 25\text{ °C}$  | MAX.  | 5    | $\mu$ A    |
|                        |   | $T_j = 125\text{ °C}$ |       | 4    | mA         |

Table 4. Thermal resistances

| Symbol        | Parameter                |                              | Value                  | Unit |      |
|---------------|--------------------------|------------------------------|------------------------|------|------|
| $R_{th(j-c)}$ | Junction to case (DC)    | D <sup>2</sup> PAK, TO-220AB | 1.0                    | °C/W |      |
|               |                          | TO-220AB ins                 | 2.0                    |      |      |
| $R_{th(j-a)}$ | Junction to ambient (DC) | $S^{(1)} = 1 \text{ cm}^2$   | D <sup>2</sup> PAK     | 45   | °C/W |
|               |                          |                              | TO-220AB, TO-220AB ins | 60   |      |

1. S = Copper surface under tab.

Figure 1. Maximum average power dissipation versus average on-state current

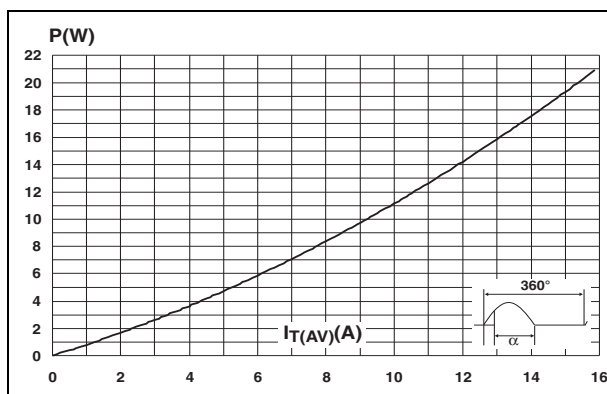

Figure 2. Average and DC on-state current versus case temperature

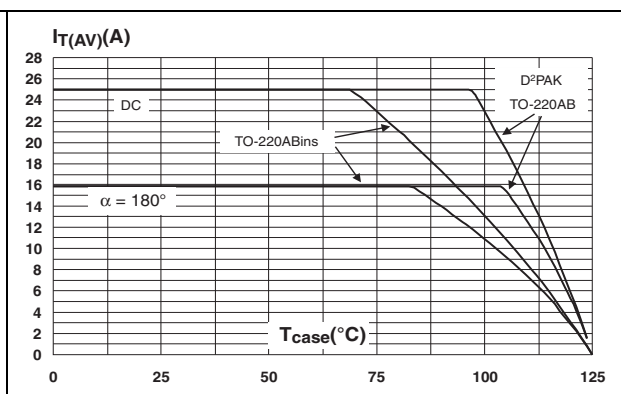

Figure 3. Average and DC on-state current versus ambient temperature

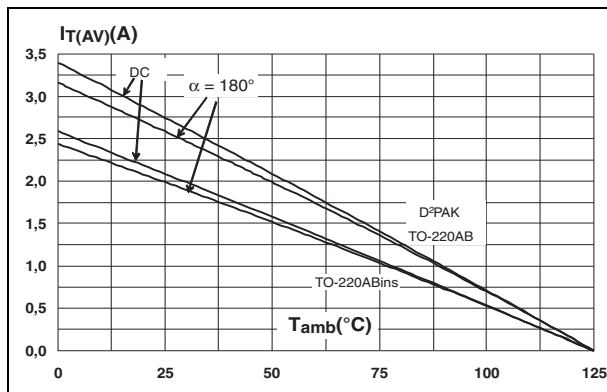

Figure 4. Relative variation of thermal impedance versus pulse duration (D<sup>2</sup>PAK, and TO-220AB)

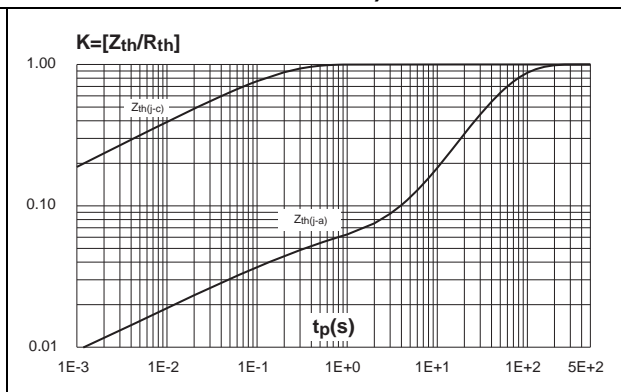

Figure 5. Relative variation of thermal impedance versus pulse duration (TO-220AB ins)

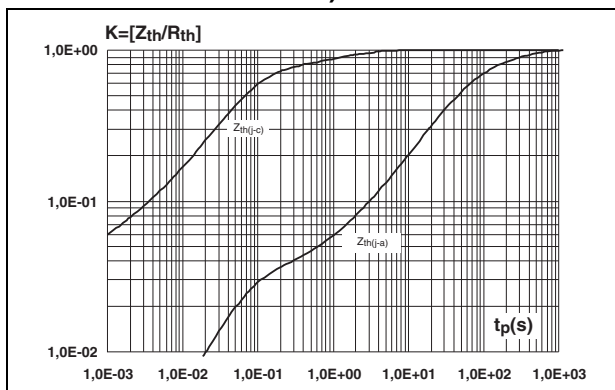

Figure 6. Relative variation of gate trigger, holding, and latching currents versus junction temperature

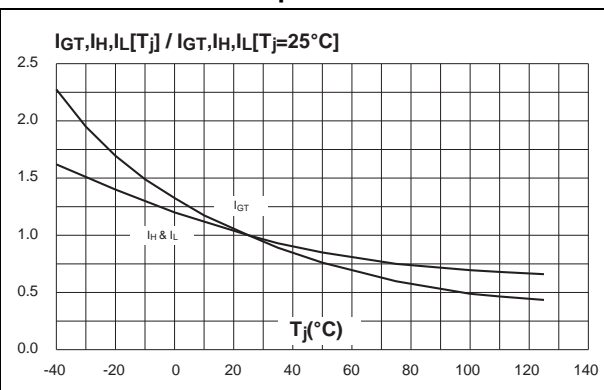

Figure 7. Surge peak on-state current versus number of cycles

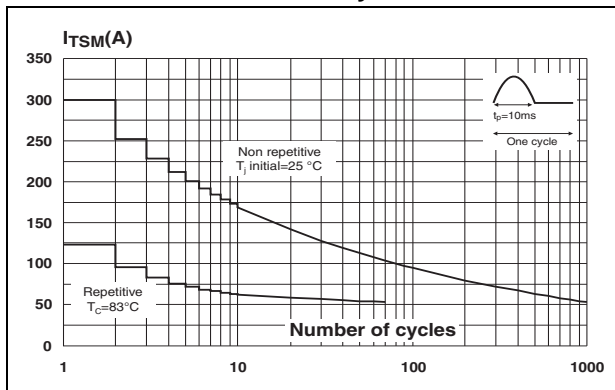

Figure 8. Non-repetitive surge peak on-state current, and corresponding values of I²t

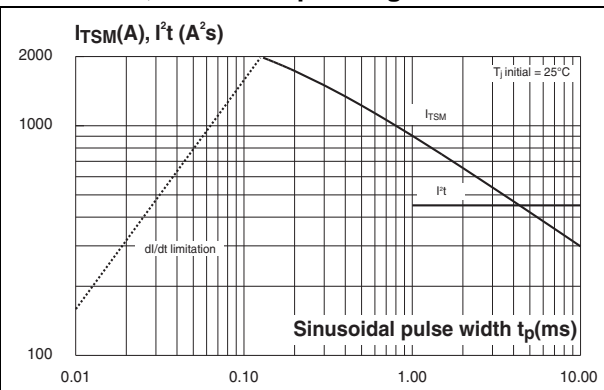

Figure 9. On-state characteristics (maximum values)

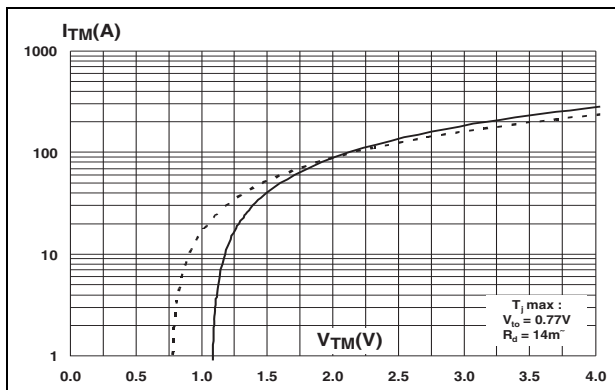
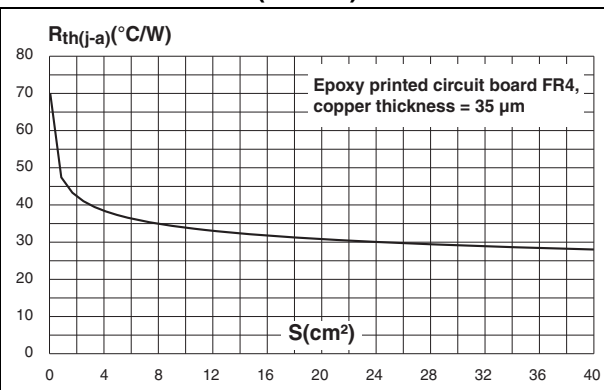

Figure 10. Thermal resistance junction to ambient versus copper surface under tab (D²PAK)



## 2 Ordering information schemes

Figure 11. TN2540-x00G ordering information scheme

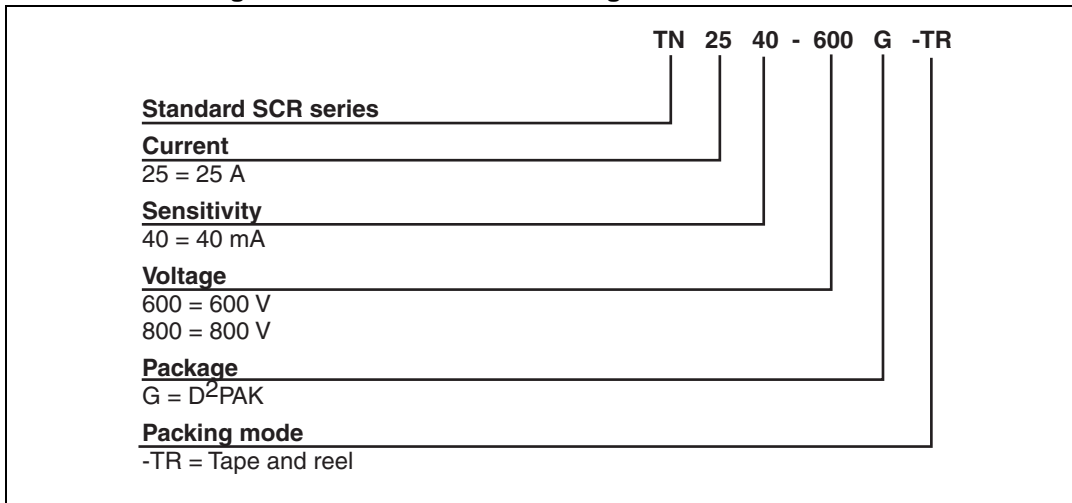

Figure 12. TXN625RG ordering information scheme

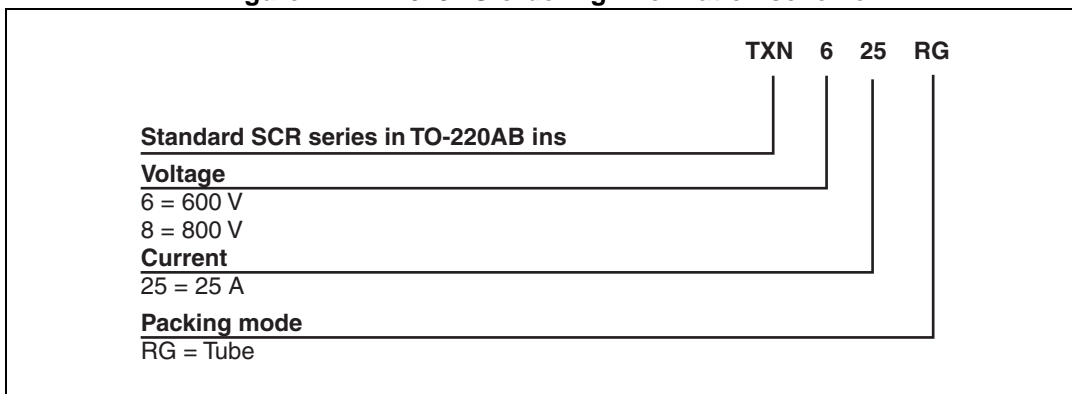
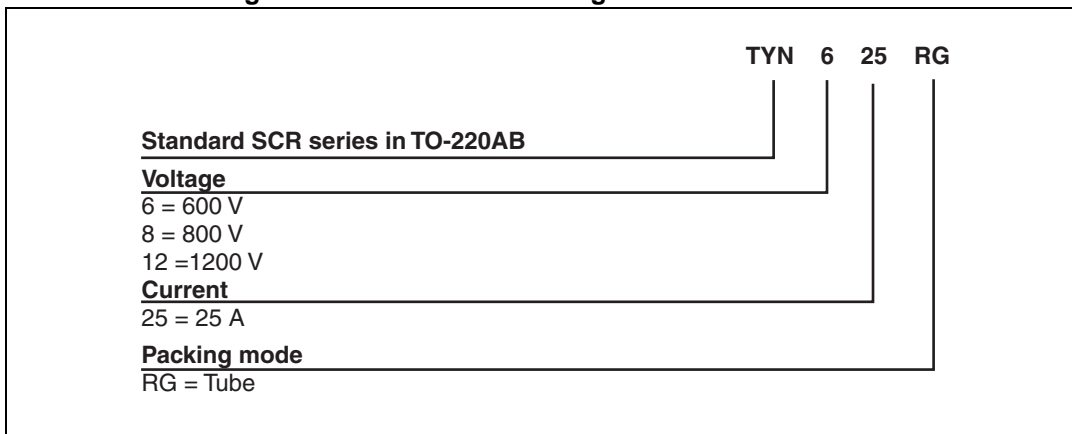

Figure 13. TYNx25RG ordering information scheme



### 3 Package information

- Epoxy meets UL94, V0
- Lead-free package
- Recommended torque values (TO-220AB, and TO220AB ins): 0.4 to 0.6 N·m

In order to meet environmental requirements, ST offers these devices in different grades of ECOPACK® packages, depending on their level of environmental compliance. ECOPACK® specifications, grade definitions and product status are available at: [www.st.com](http://www.st.com). ECOPACK® is an ST trademark.

Figure 14. TO-220AB (Nlns. & Ins. 20-up) dimension definitions

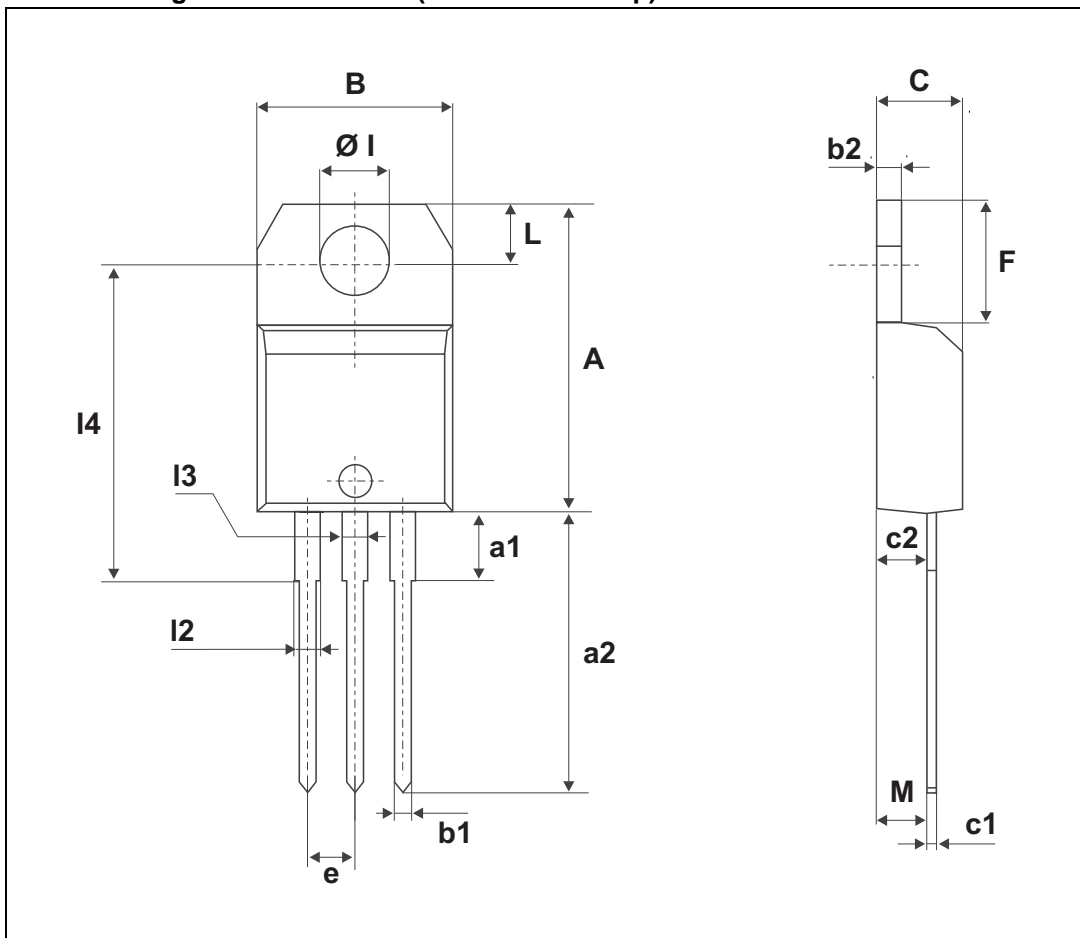

Table 5. TO-220AB (Nlns. &amp; Ins. 20-up) dimension values

| Ref. | Dimensions  |       |       |        |       |       |
|------|-------------|-------|-------|--------|-------|-------|
|      | Millimeters |       |       | Inches |       |       |
|      | Min.        | Typ.  | Max.  | Min.   | Typ.  | Max.  |
| A    | 15.20       |       | 15.90 | 0.598  |       | 0.625 |
| a1   |             | 3.75  |       |        | 0.147 |       |
| a2   | 13.00       |       | 14.00 | 0.511  |       | 0.551 |
| B    | 10.00       |       | 10.40 | 0.393  |       | 0.409 |
| b1   | 0.61        |       | 0.88  | 0.024  |       | 0.034 |
| b2   | 1.23        |       | 1.32  | 0.048  |       | 0.051 |
| C    | 4.40        |       | 4.60  | 0.173  |       | 0.181 |
| c1   | 0.49        |       | 0.70  | 0.019  |       | 0.027 |
| c2   | 2.40        |       | 2.70  | 0.094  |       | 0.107 |
| e    | 2.40        |       | 2.70  | 0.094  |       | 0.106 |
| F    | 6.20        |       | 6.60  | 0.244  |       | 0.259 |
| ØI   | 3.75        |       | 3.85  | 0.147  |       | 0.151 |
| l4   | 15.80       | 16.40 | 16.80 | 0.622  | 0.646 | 0.661 |
| L    | 2.65        |       | 2.95  | 0.104  |       | 0.116 |
| l2   | 1.14        |       | 1.70  | 0.044  |       | 0.066 |
| l3   | 1.14        |       | 1.70  | 0.044  |       | 0.066 |
| M    |             | 2.60  |       |        | 0.102 |       |

Figure 15. D<sup>2</sup>PAK dimensions definitions

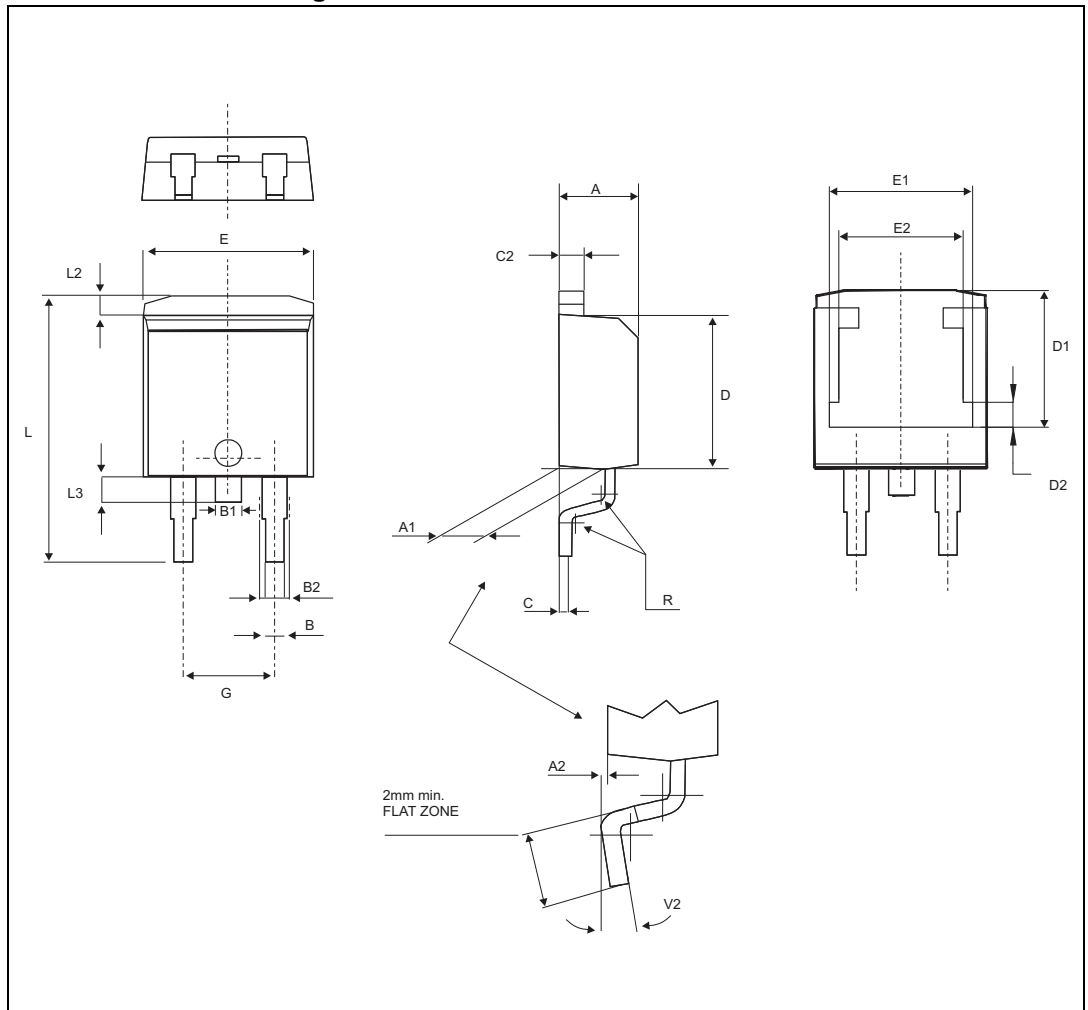
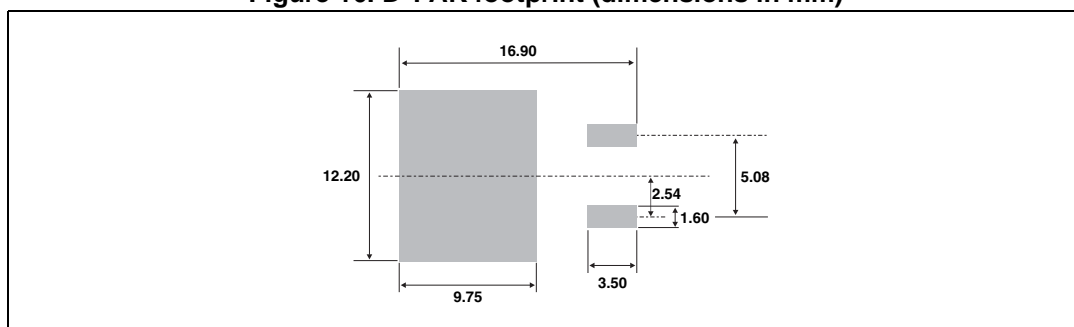



Table 6. D<sup>2</sup>PAK dimensions values

| Ref. | Dimensions  |      |       |        |       |       |
|------|-------------|------|-------|--------|-------|-------|
|      | Millimeters |      |       | Inches |       |       |
|      | Min.        | Typ. | Max.  | Min.   | Typ.  | Max.  |
| A    | 4.30        |      | 4.60  | 0.169  |       | 0.181 |
| A1   | 2.49        |      | 2.69  | 0.098  |       | 0.106 |
| A2   | 0.03        |      | 0.23  | 0.001  |       | 0.009 |
| B    | 0.70        |      | 0.93  | 0.027  |       | 0.037 |
| B1   | 1.20        |      | 1.38  | 0.047  |       | 0.054 |
| B2   | 1.25        | 1.40 |       | 0.048  | 0.055 |       |
| C    | 0.45        |      | 0.60  | 0.017  |       | 0.024 |
| C2   | 1.21        |      | 1.36  | 0.047  |       | 0.054 |
| D    | 8.95        |      | 9.35  | 0.352  |       | 0.368 |
| D1   | 7.5         |      | 8.0   | 0.295  |       | 0.314 |
| D2   | 1.3         |      | 1.7   | 0.051  |       | 0.067 |
| E    | 10.00       |      | 10.28 | 0.393  |       | 0.405 |
| E1   | 8.3         |      | 8.7   | 0.326  |       | 0.342 |
| E2   | 6.85        |      | 7.25  | 0.269  |       | 0.285 |
| G    | 4.88        |      | 5.28  | 0.192  |       | 0.208 |
| L    | 15.00       |      | 15.85 | 0.590  |       | 0.624 |
| L2   | 1.27        |      | 1.40  | 0.050  |       | 0.055 |
| R    | 0.40        |      |       | 0.016  |       |       |
| V2   | 0°          |      | 8°    | 0°     |       | 8°    |

Figure 16. D<sup>2</sup>PAK footprint (dimensions in mm)

## 4 Ordering information

Table 7. Ordering information

| Order code     | Voltage | Sensitivity | Marking    | Package            | Weight | Base qty | Delivery mode |
|----------------|---------|-------------|------------|--------------------|--------|----------|---------------|
| TN2540-600G-TR | 600 V   | 40 mA       | TN2540600G | D <sup>2</sup> PAK | 1.5 g  | 1000     | Tape & reel   |
| TN2540-800G-TR | 800 V   | 40 mA       | TN2540800G | D <sup>2</sup> PAK | 1.5 g  | 1000     | Tape & reel   |
| TXN625RG       | 600 V   | 40 mA       | TXN625     | TO-220AB<br>ins    | 2.3 g  | 50       | Tube          |
| TYN625RG       | 600 V   | 40 mA       | TYN625     | TO-220AB           | 2.3 g  | 50       | Tube          |
| TYN825RG       | 800 V   | 40 mA       | TYN825     | TO-220AB           | 2.3 g  | 50       | Tube          |
| TYN1225RG      | 1200 V  | 40 mA       | TYN1225    | TO-220AB           | 2.3 g  | 50       | Tube          |

## 5 Revision history

Table 8. Document revision history

| Date        | Revision | Changes   |
|-------------|----------|---|
| Apr-2002    | 4A       | Previous update   |
| 13-Feb-2006 | 5        | TO-220AB delivery mode changed from bulk to tube.<br>ECOPACK statement added. |
| 17-Jun-2011 | 6        | Added TXN625.   |
| 13-Sep-2011 | 7        | Added UL certification in <a href="#">Features</a> .                          |
| 07-Feb-2012 | 8        | Added TYN1225.  |
| 20-Aug-2014 | 9        | Updated <a href="#">Section 3: Package information</a> .                      |

**IMPORTANT NOTICE – PLEASE READ CAREFULLY**

STMicroelectronics NV and its subsidiaries ("ST") reserve the right to make changes, corrections, enhancements, modifications, and improvements to ST products and/or to this document at any time without notice. Purchasers should obtain the latest relevant information on ST products before placing orders. ST products are sold pursuant to ST's terms and conditions of sale in place at the time of order acknowledgement.

Purchasers are solely responsible for the choice, selection, and use of ST products and ST assumes no liability for application assistance or the design of Purchasers' products.

No license, express or implied, to any intellectual property right is granted by ST herein.

Resale of ST products with provisions different from the information set forth herein shall void any warranty granted by ST for such product.

ST and the ST logo are trademarks of ST. All other product or service names are the property of their respective owners.

Information in this document supersedes and replaces information previously supplied in any prior versions of this document.

© 2014 STMicroelectronics – All rights reserved