

SPECIFICATION

Part No.	:	TG.22.0111W
Product Name	:	Penta-Band Cellular Connector Mount Monopole Helical Antenna GSM-DCS-PCS-UMTS-CDMA-GPRS-EDGE-HSPA 800MHz ~2200 MHz
Features	:	0dBi Gain Straight SMA Male, 50 Ohms White Housing RoHS Compliant



1. Introduction

The TG.22.0111W, Penta-band GSM-DCS-PCS-UMTS-CDMA-GPRS-EDGE-HSPA 800MHz to 2200MHz monopole helical antenna is a quality robust antenna with high gain in small form factor. Connection is made via straight SMA(M) connector. With a hardened waterproof PU casing, this antenna is the ideal GSM antenna for telematics devices.

2. Key Antenna Performance Indicators

Electrical Specifications

Parameter	Specification
Frequency range	800MHz to 2200MHz
Bands	GSM-DCS-PCS-UMTS-CDMA-GPRS-EDGE-HSPA
VSWR	≤ 2.3
Polarization	Linear
Power handling	20 W
Impedance	50 Ohms
Connector	Straight SMA(M)

Environmental & Mechanical Characteristics

Parameter	Specification
Temperature	-40°C to +85°C
Radome color	White
Radome material	Pu
Weight	6 g

3. Performance Measurements

3.1 Return Loss (dB)

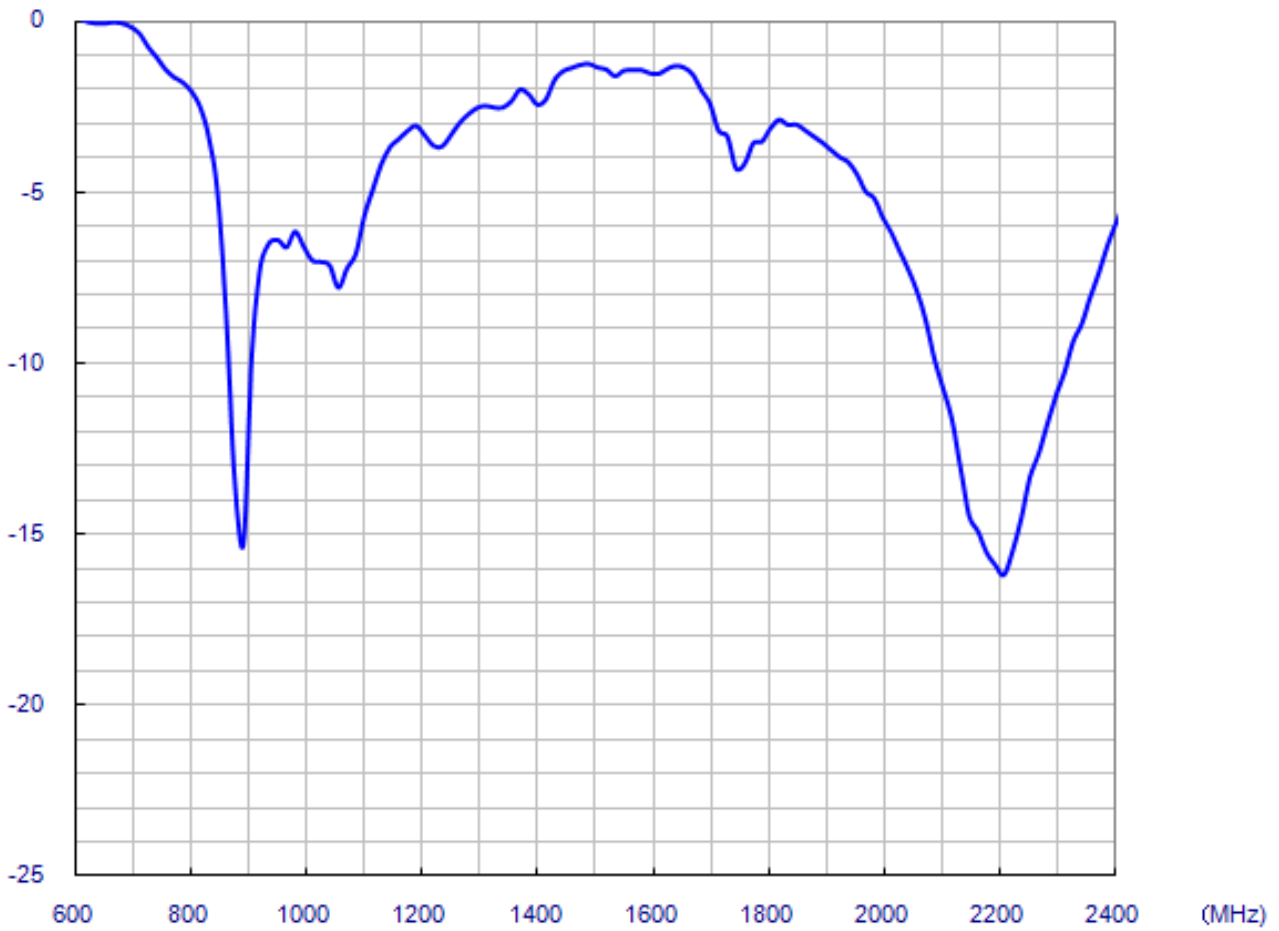

3.2 Efficiency (dB)

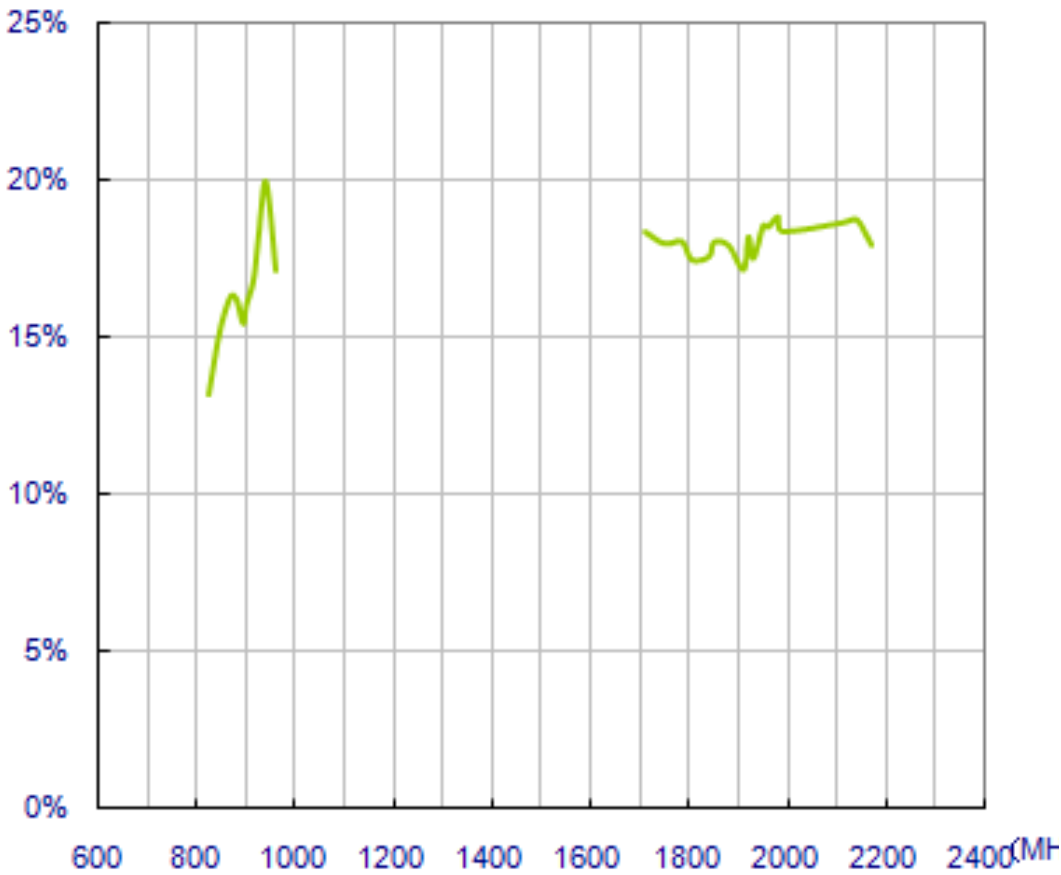

TG-22-0111	
Frequency	Efficiency
824	13.18%
836	14.31%
849	15.37%
869	16.30%
880	16.21%
894	15.43%
900	16.01%
915	16.83%
925	18.20%
940	19.92%
960	17.11%
1575	14.98%
1710	18.33%
1750	17.96%
1785	18.03%
1805	17.45%
1840	17.55%
1850	18.01%
1880	17.90%
1910	17.13%
1920	18.18%
1930	17.50%
1950	18.53%
1960	18.48%
1980	18.81%
1990	18.35%
2110	18.62%
2140	18.72%
2170	17.92%

3.3 Radiation Pattern Data



3.3.1 Radiation Pattern, Aligned at the Connector

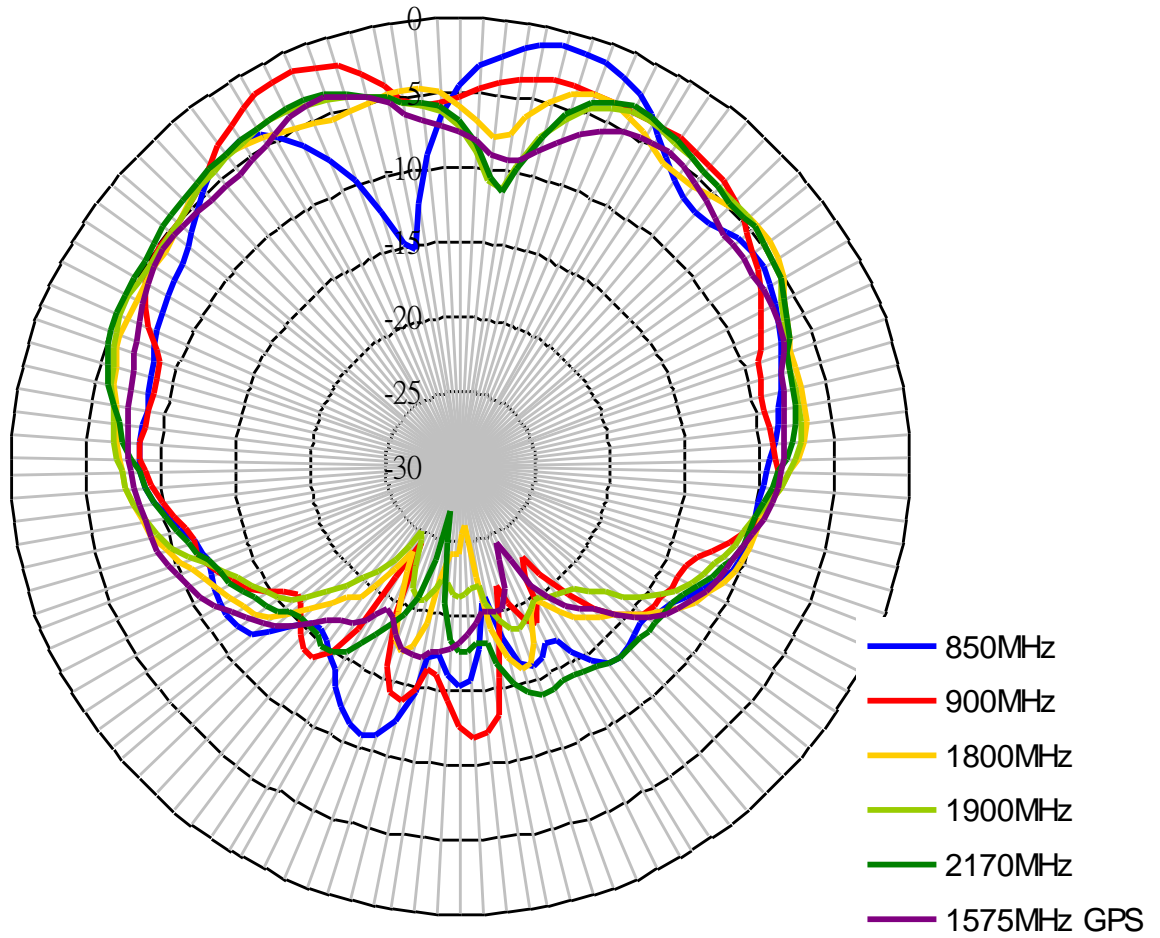

3.3.2 Radiation Pattern, Azimuth Plane (XY)

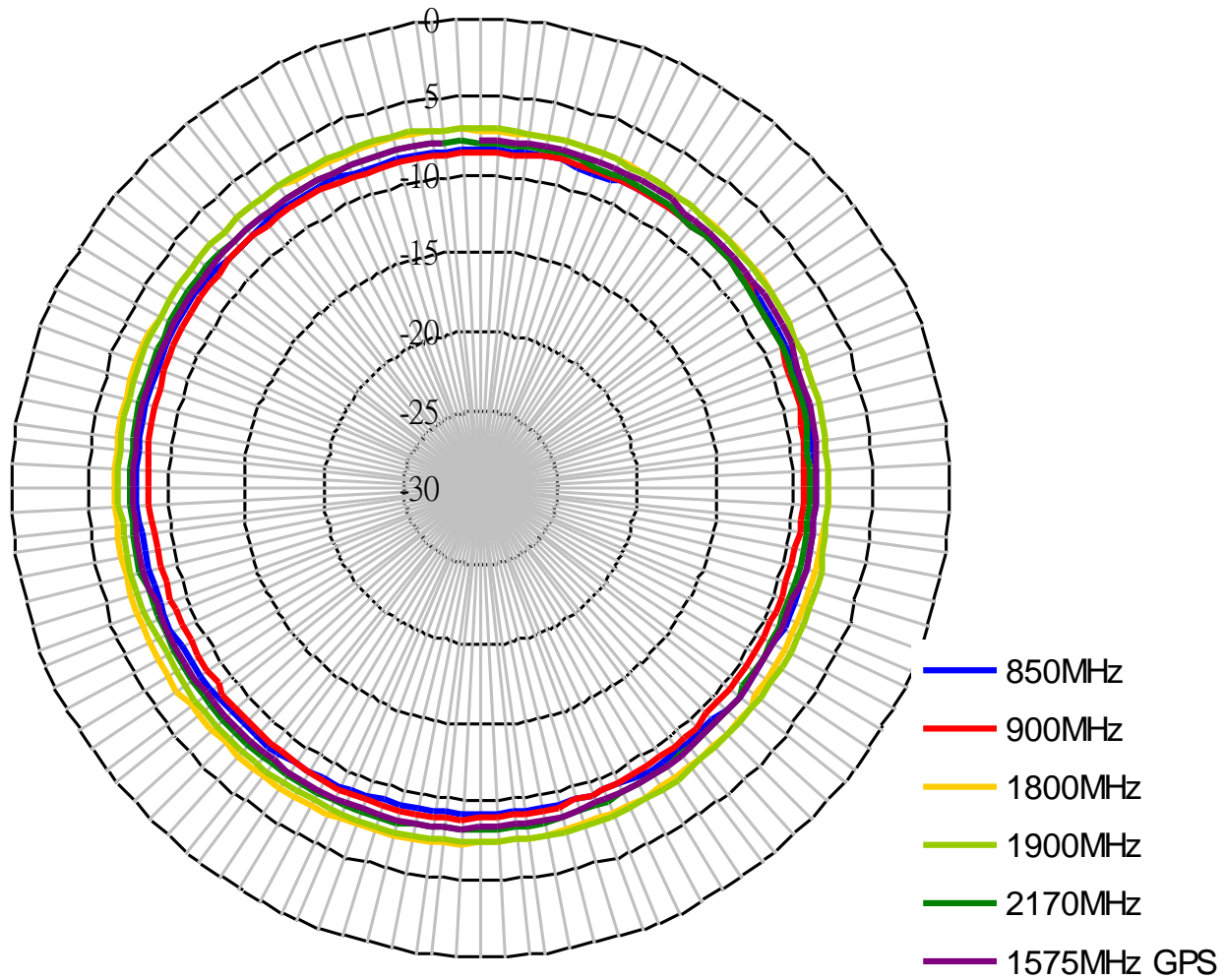

3.3.3 Radiation pattern – Aligned at the connector 1575MHz only

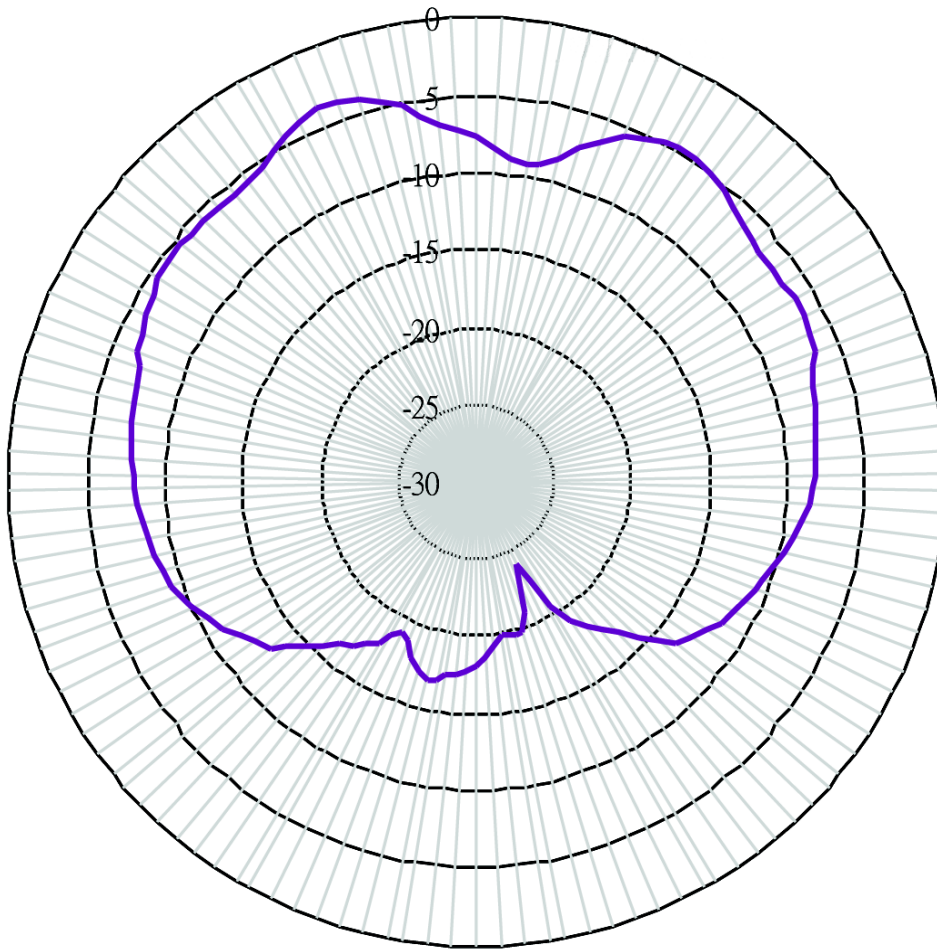

3.3.4 Radiation Pattern, Azimuth Plane (XY) – 1575MHz only

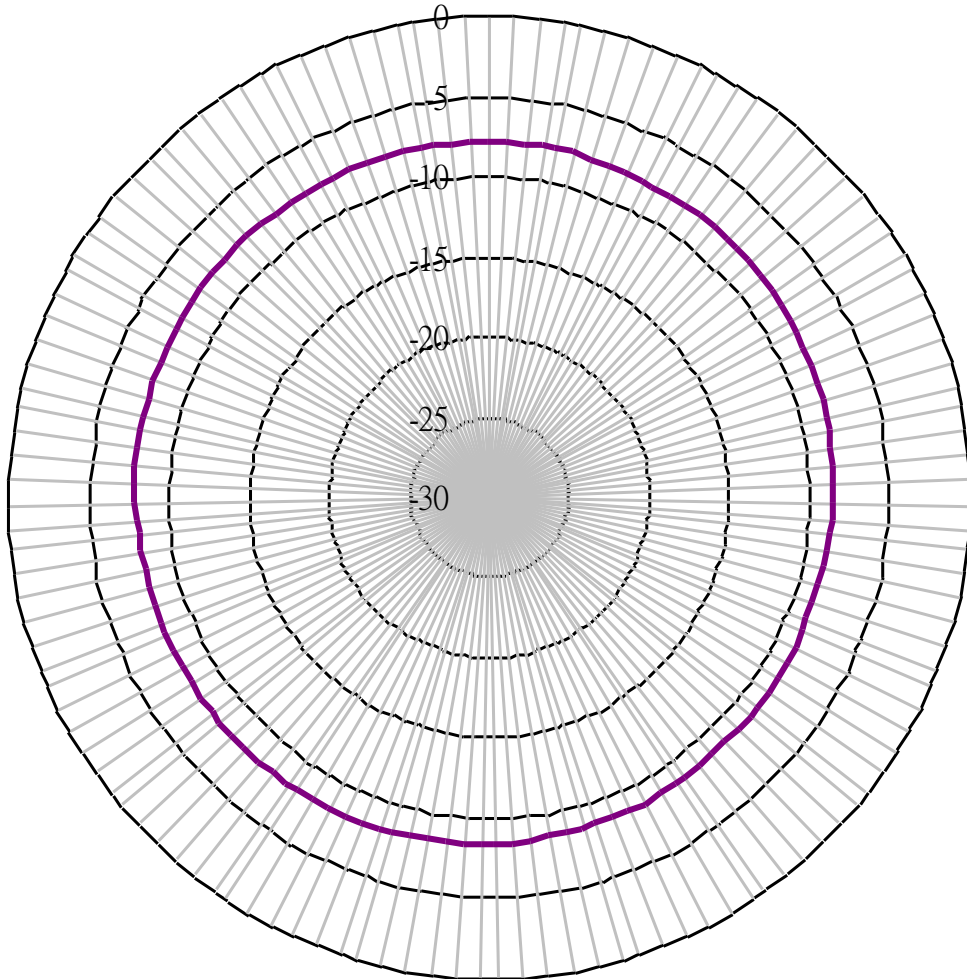

4. Drawing and Dimensions (unit: mm)

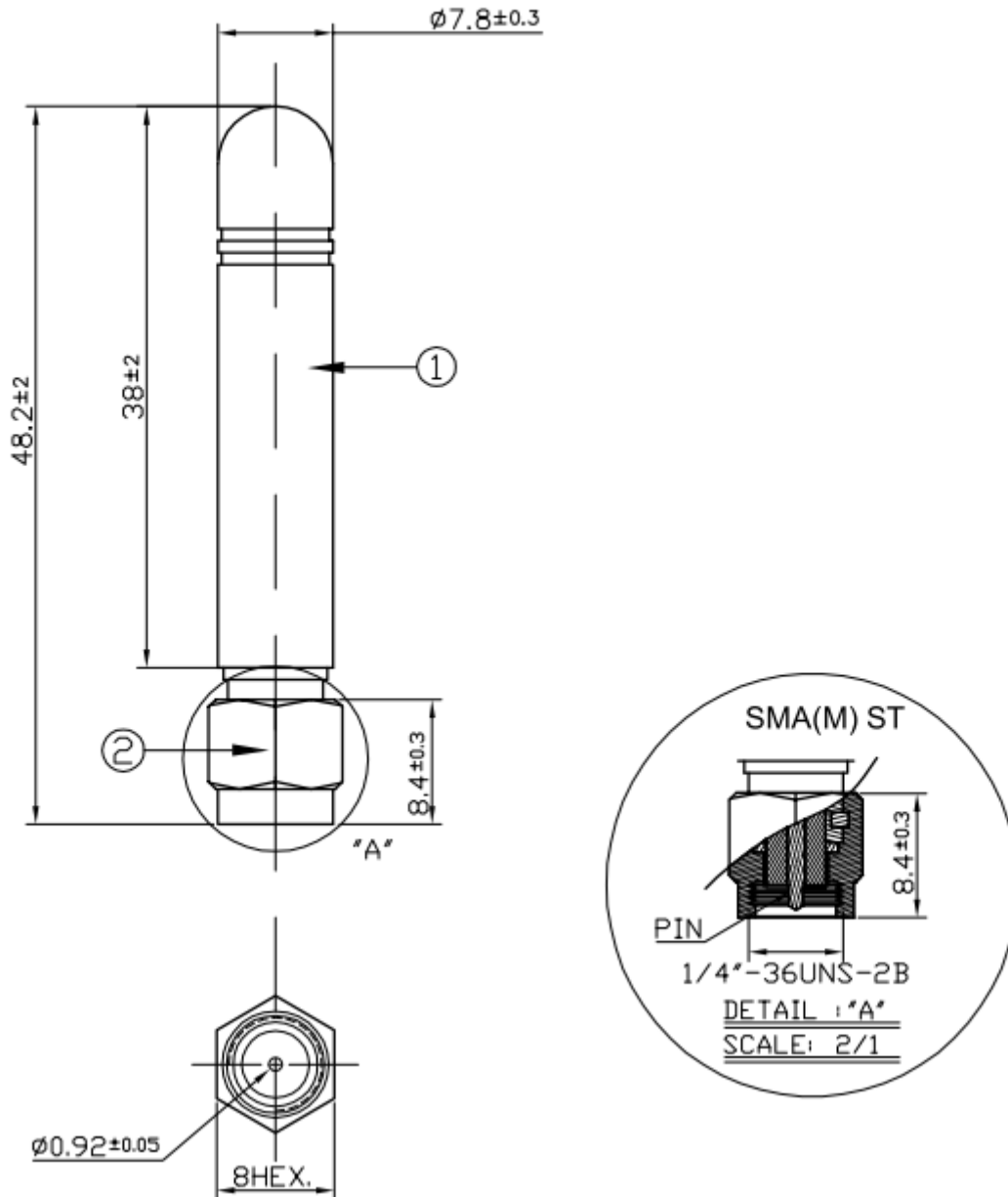

	Name	Material	Finish	Quantity
1	Antenna Housing	TPEE	White	1
2	SMA(M) ST	Brass	Gold	1

5. Packaging

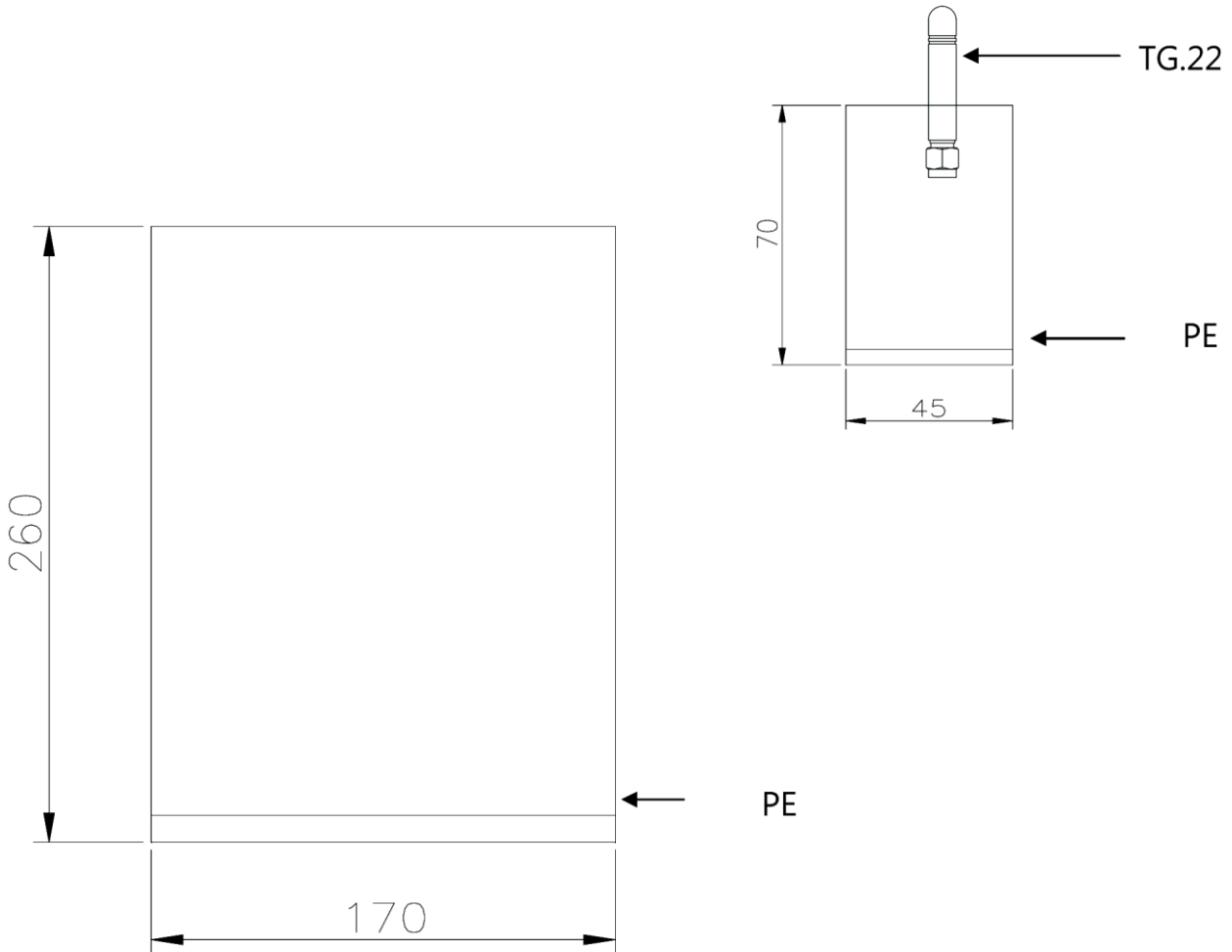

1pcs antennas per small PE bag.

100 small PE bags per big PE bag.

100pcs antennas per big sealed PE bag.

6. Installation

- 1) Use hand to screw the SMA connector.
Tighten it until it feels a little tight.



- 2) Use torque wrench which has 0.9 Nm torque limit to tighten it.



- 3) Do not use normal wrench.

