

MAX44241/MAX44243/MAX44246

36V, Low-Noise, Precision, Single/Quad/Dual Op Amps

General Description

The MAX44241/MAX44243/MAX44246 are 36V, ultra-precision, low-noise, low-drift, single/quad/dual operational amplifiers that offer near-zero DC offset and drift through the use of patented chopper stabilized and auto-zeroing techniques. This method constantly measures and compensates the input offset, eliminating drift over time and temperature and the effect of $1/f$ noise. These single/quad/dual devices feature rail-to-rail outputs, operate from a single 2.7V to 36V supply or dual $\pm 1.35V$ to $\pm 18V$ supplies, and consume only 0.42mA per channel, with only $9nV/\sqrt{Hz}$ input-referred voltage noise.

The ICs are unity-gain stable with a gain-bandwidth product of 5MHz. With excellent specifications such as offset voltage of $5\mu V$ (max), drift of $20nV/^\circ C$ (max), and $117nV_{p-p}$ noise in 0.1Hz to 10Hz, these ICs are ideally suited for applications requiring ultra-low noise, and DC precision such as interfacing with pressure sensors, strain gauges, precision weight scales, and medical instrumentation.

The ICs are available in 8-pin μMAX ® or SO packages and are rated over the $-40^\circ C$ to $+125^\circ C$ temperature range.

Applications

| | |
|---------------------------|---------------------------|
| Transducer Amplifiers | Battery-Powered Equipment |
| Load Cell Amplifiers | PLC Analog I/O Modules |
| Precision Instrumentation | |

- ◆ 2.7V to 36V Power-Supply Range
- ◆ Ultra-Low Input V_{OS} : $5\mu V$ (max)
- ◆ Low $20nV/^\circ C$ (max) of Offset Drift
- ◆ Low $9nV/\sqrt{Hz}$ noise at 1kHz
- ◆ $1\mu s$ Fast Settling Time
- ◆ 5MHz Gain-Bandwidth Product
- ◆ Rail-to-Rail Output
- ◆ Integrated EMI Filter
- ◆ Low 0.55mA Per Channel (max) Quiescent Current
- ◆ 8-Pin $\mu MAX/SO$ Package

Ordering Information appears at end of data sheet.

For related parts and recommended products to use with this part, refer to www.maximintegrated.com/MAX44246.related.

μMAX is a registered trademark of Maxim Integrated Products, Inc.

Typical Operating Circuit

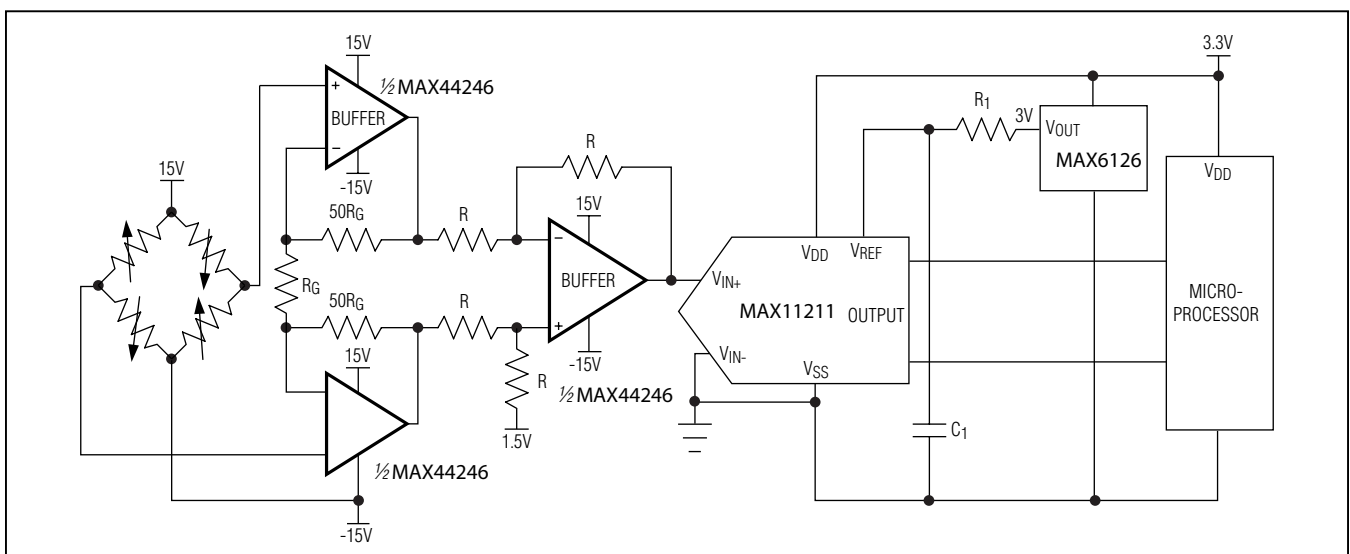

For pricing, delivery, and ordering information, please contact Maxim Direct at 1-888-629-4642, or visit Maxim's website at www.maximintegrated.com.

MAX44241/MAX44243/MAX44246

36V, Low-Noise, Precision, Single/Quad/Dual Op Amps

ABSOLUTE MAXIMUM RATINGS

| | | | |
|--|------------------------------------|--|-----------------|
| Supply Voltage (V_{DD} to GND) | -0.3V to +40V | 8-Pin SO (derate 7.60mW/°C above +70°C)..... | 606.1mW |
| All Other Pins..... | (GND - 0.3V) to (V_{DD} + 0.3V) | 14-Pin SO (derate 12.30mW/°C above +70°C)..... | 987.7mW |
| Short-Circuit Duration, OUTA, OUTB to Either Supply Rail..... | 1s | 14-Pin TSSOP (derate 10mW/°C above +70°C)..... | 796.8mW |
| Continuous Input Current (Any Pin) | 20mA | Operating Temperature Range | -40°C to +125°C |
| Differential Input Current..... | ±20mA | Junction Temperature | +150°C |
| Differential Input Voltage (Note 1)..... | ±6V | Storage Temperature Range..... | -65°C to +150°C |
| Continuous Power Dissipation (T_A = +70°C) | | Lead Temperature (soldering, 10s) | +300°C |
| 5-Pin SOT23 (derate 3.9mW/°C above +70°C)..... | 312.6mW | Soldering Temperature (reflow) | +260°C |
| 8-Pin μ MAX (derate 4.8mW/°C above +70°C)..... | 387.8mW | | |

Note 1: The amplifier inputs are connected by internal back-to-back clamp diodes. In order to minimize noise in the input stage, current-limiting resistors are not used. If differential input voltages exceeding $\pm 1V$ are applied, limit input current to 20mA.

Stresses beyond those listed under "Absolute Maximum Ratings" may cause permanent damage to the device. These are stress ratings only, and functional operation of the device at these or any other conditions beyond those indicated in the operational sections of the specifications is not implied. Exposure to absolute maximum rating conditions for extended periods may affect device reliability.

PACKAGE THERMAL CHARACTERISTICS (Note 2)

| | | | |
|--|-----------|--|-----------|
| μ MAX | SOT23 | | |
| Junction-to-Ambient Thermal Resistance (θ_{JA}) | 206.3°C/W | Junction-to-Ambient Thermal Resistance (θ_{JA}) | 255.9°C/W |
| Junction-to-Case Thermal Resistance (θ_{JC}) | 42°C/W | Junction-to-Case Thermal Resistance (θ_{JC}) | 81°C/W |
| SO-8 | TSSOP | | |
| Junction-to-Ambient Thermal Resistance (θ_{JA}) | 132°C/W | Junction-to-Ambient Thermal Resistance (θ_{JA}) | 100.4°C/W |
| Junction-to-Case Thermal Resistance (θ_{JC}) | 38°C/W | Junction-to-Case Thermal Resistance (θ_{JC}) | 30°C/W |
| SO-14 | | | |
| Junction-to-Ambient Thermal Resistance (θ_{JA}) | 81°C/W | | |
| Junction-to-Case Thermal Resistance (θ_{JC}) | 32°C/W | | |

Note 2: Package thermal resistances were obtained using the method described in JEDEC specification JESD51-7, using a four-layer board. For detailed information on package thermal considerations, refer to www.maximintegrated.com/thermal-tutorial.

ELECTRICAL CHARACTERISTICS

(V_{DD} = 30V, V_{GND} = 0V, V_{IN+} = V_{IN-} = $V_{DD}/2$, R_L = 5k Ω to $V_{DD}/2$, T_A = -40°C to +125°C, unless otherwise noted. Typical values at T_A = +25°C.) (Note 3)

| PARAMETER | SYMBOL | CONDITIONS | MIN | TYP | MAX | UNITS |
|---------------------------------------|----------|---|------------------------|-----|-------------------|---------|
| Supply Voltage Range | V_{DD} | Guaranteed by PSRR | 2.7 | | 36 | V |
| Power-Supply Rejection Ratio (Note 4) | PSRR | V_{DD} = 2.7V to 36V, T_A = +25°C | 148 | 166 | | dB |
| | | V_{DD} = 2.7V to 36V, -40°C < T_A < +125°C | 146 | | | |
| Quiescent Current per Amplifier | I_{DD} | R_L = ∞ | T_A = +25°C | | 0.60 | mA |
| | | | -40°C < T_A < +125°C | | | |
| Power-Up Time | t_{ON} | | | 20 | | μ s |
| DC SPECIFICATIONS | | | | | | |
| Input Common-Mode Range | V_{CM} | Guaranteed by CMRR test | (V_{GND} - 0.05) | | (V_{DD} - 1.5) | V |
| Common-Mode Rejection Ratio (Note 4) | CMRR | V_{CM} = (V_{GND} - 0.05V) to (V_{DD} - 1.5V) | 146 | 166 | | dB |
| Input Offset Voltage (Note 4) | V_{OS} | | | 1 | 5 | μ V |

MAX44241/MAX44243/MAX44246

36V, Low-Noise, Precision, Single/Quad/Dual Op Amps

ELECTRICAL CHARACTERISTICS (continued)

($V_{DD} = 30V$, $V_{GND} = 0V$, $V_{IN+} = V_{IN-} = V_{DD}/2$, $R_L = 5k\Omega$ to $V_{DD}/2$, $T_A = -40^\circ C$ to $+125^\circ C$, unless otherwise noted. Typical values at $T_A = +25^\circ C$.) (Note 3)

| PARAMETER | SYMBOL | CONDITIONS | MIN | TYP | MAX | UNITS |
|-------------------------------------|-------------|--|-------------------|-------------------|------|-------|
| Input Offset Voltage Drift (Note 4) | $TC V_{OS}$ | | | 1 | 20 | nV/°C |
| Input Bias Current (Note 4) | I_B | $T_A = +25^\circ C$ | | 300 | 600 | pA |
| | | $-40^\circ C < T_A < +125^\circ C$ | | | 1250 | |
| Input Offset Current (Note 4) | I_{OS} | $T_A = +25^\circ C$ | | 600 | 1200 | pA |
| | | $-40^\circ C < T_A < +125^\circ C$ | | | 2500 | |
| Open-Loop Gain (Note 4) | A_{VOL} | $(V_{GND} + 0.5V) \leq V_{OUT} \leq (V_{DD} - 0.5V)$ | 154 | 168 | | dB |
| Output Short-Circuit Current | | Noncontinuous | Sinking | 40 | | mA |
| | | | Sourcing | 30 | | |
| Output Voltage Low | V_{OL} | $T_A = +25^\circ C$ | | 90 | 115 | mV |
| | | $-40^\circ C < T_A < +125^\circ C$ | | | 180 | |
| Output Voltage High | V_{OH} | $T_A = +25^\circ C$ | $(V_{DD} - 0.17)$ | $(V_{DD} - 0.13)$ | | V |
| | | $-40^\circ C < T_A < +125^\circ C$ | $(V_{DD} - 0.25)$ | | | |

AC SPECIFICATIONS

| | | | | | | |
|-----------------------------|----------|---|-------------|-----|--|-------------------|
| Input Voltage-Noise Density | e_N | $f = 1kHz$ | | 9 | | nV/ \sqrt{Hz} |
| Input Voltage Noise | | $0.1Hz < f < 10Hz$ | | 117 | | nV _{P-P} |
| Input Capacitance | C_{IN} | | | 2 | | pF |
| Gain-Bandwidth Product | GBW | | | 5 | | MHz |
| Phase Margin | PM | $C_L = 20pF$ | | 60 | | Degrees |
| Slew Rate | SR | $A_V = 1V/V$, $V_{OUT} = 4V_{P-P}$ | | 3.8 | | V/ μs |
| Capacitive Loading | C_L | No sustained oscillation, $A_V = 1V/V$ | | 300 | | pF |
| Total Harmonic Distortion | THD | $V_{OUT} = 4V_{P-P}$, $A_V = +1V/V$ | $f = 1kHz$ | -96 | | dB |
| | | | $f = 20kHz$ | -77 | | |
| | | $V_{OUT} = 2V_{P-P}$, $A_V = +1V/V$ | $f = 1kHz$ | -91 | | dB |
| | | | $f = 20kHz$ | -76 | | |

ELECTRICAL CHARACTERISTICS

($V_{DD} = 10V$, $V_{GND} = 0V$, $V_{IN+} = V_{IN-} = V_{DD}/2$, $R_L = 5k\Omega$ to $V_{DD}/2$, $T_A = -40^\circ C$ to $+125^\circ C$, unless otherwise noted. Typical values at $T_A = +25^\circ C$.) (Note 3)

| PARAMETER | SYMBOL | CONDITIONS | MIN | TYP | MAX | UNITS |
|---------------------------------|----------|----------------|------------------------------------|------|------|---------|
| POWER SUPPLY | | | | | | |
| Quiescent Current per Amplifier | I_{DD} | $R_L = \infty$ | $T_A = +25^\circ C$ | 0.42 | 0.55 | mA |
| | | | $-40^\circ C < T_A < +125^\circ C$ | | 0.60 | |
| Power-Up Time | t_{ON} | | | 20 | | μs |

MAX44241/MAX44243/MAX44246

36V, Low-Noise, Precision, Single/Quad/Dual Op Amps

ELECTRICAL CHARACTERISTICS (continued)

($V_{DD} = 10V$, $V_{GND} = 0V$, $V_{IN+} = V_{IN-} = V_{DD}/2$, $R_L = 5k\Omega$ to $V_{DD}/2$, $T_A = -40^\circ C$ to $+125^\circ C$, unless otherwise noted. Typical values at $T_A = +25^\circ C$.) (Note 3)

| PARAMETER | SYMBOL | CONDITIONS | MIN | TYP | MAX | UNITS |
|--------------------------------------|-------------|--|--------------------|-------------------|------------------|-------------------|
| DC SPECIFICATIONS | | | | | | |
| Input Common-Mode Range | V_{CM} | Guaranteed by CMRR test | $(V_{GND} - 0.05)$ | | $(V_{DD} - 1.5)$ | V |
| Common-Mode Rejection Ratio (Note 4) | CMRR | $V_{CM} = (V_{GND} - 0.05V)$ to $(V_{DD} - 1.5V)$ | 140 | 158 | | dB |
| Input Offset Voltage (Note 4) | V_{OS} | | | 1 | 5 | μV |
| Input Offset Voltage Drift (Note 4) | TC V_{OS} | | | 2.4 | 20 | nV/ $^\circ C$ |
| Input Bias Current (Note 4) | I_B | $T_A = +25^\circ C$ | | 300 | 600 | pA |
| | | $-40^\circ C < T_A < +125^\circ C$ | | | 1100 | |
| Input Offset Current (Note 4) | I_{OS} | $T_A = +25^\circ C$ | | 600 | 1200 | pA |
| | | $-40^\circ C < T_A < +125^\circ C$ | | | 2200 | |
| Open-Loop Gain (Note 4) | A_{VOL} | $(V_{GND} + 0.5V) \leq V_{OUT} \leq (V_{DD} - 0.5V)$ | 144 | 164 | | dB |
| Output Short-Circuit Current | | Noncontinuous | Sinking | 40 | | mA |
| | | | Sourcing | 30 | | |
| Output Voltage Low | V_{OL} | $T_A = +25^\circ C$ | | 30 | 40 | mV |
| | | $-40^\circ C < T_A < +125^\circ C$ | | | 60 | |
| Output Voltage High | V_{OH} | $T_A = +25^\circ C$ | $(V_{DD} - 0.06)$ | $(V_{DD} - 0.05)$ | | V |
| | | $-40^\circ C < T_A < +125^\circ C$ | $(V_{DD} - 0.09)$ | | | |
| AC SPECIFICATIONS | | | | | | |
| Input Voltage-Noise Density | e_N | $f = 1kHz$ | | 9 | | nV/ \sqrt{Hz} |
| Input Voltage Noise | | $0.1Hz < f < 10Hz$ | | 117 | | nV _{P-P} |
| Input Capacitance | C_{IN} | | | 2 | | pF |
| Gain-Bandwidth Product | GBW | | | 5 | | MHz |
| Phase Margin | PM | $C_L = 20pF$ | | 60 | | Degrees |
| Slew Rate | SR | $A_V = +1V/V$, $V_{OUT} = 2V_{P-P}$, 10% to 90% | | 3.8 | | V/ μs |
| Capacitive Loading | C_L | No sustained oscillation, $A_V = 1V/V$ | | 300 | | pF |
| Total Harmonic Distortion | THD | $V_{OUT} = 2V_{P-P}$, $A_V = 1V/V$ | $f = 1kHz$ | -92 | | dB |
| | | | $f = 20kHz$ | -76 | | |
| Settling Time | | To 0.01%, $V_{OUT} = 2V$ step, $A_V = 1V/V$ | | 1 | | μs |

Note 3: All devices are 100% production tested at $T_A = +25^\circ C$. Temperature limits are guaranteed by design.

Note 4: Guaranteed by design.

MAX44241/MAX44243/MAX44246

36V, Low-Noise, Precision, Single/Quad/Dual Op Amps

Typical Operating Characteristics

($V_{DD} = 10V$, $V_{GND} = 0V$, $V_{IN+} = V_{IN-} = V_{DD}/2$, $R_L = 5k\Omega$ to $V_{DD}/2$, $T_A = -40^\circ C$ to $+125^\circ C$, unless otherwise noted. Typical values are at $T_A = +25^\circ C$.) (Note 3)

INPUT OFFSET VOLTAGE HISTOGRAM

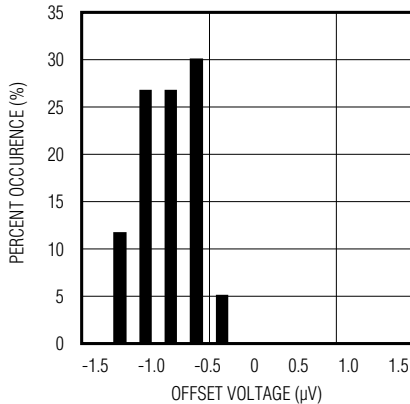

INPUT OFFSET VOLTAGE DRIFT HISTOGRAM

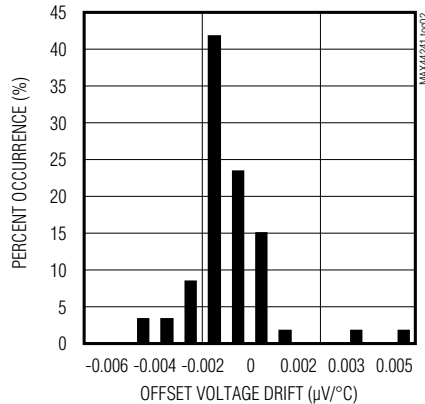

SUPPLY CURRENT PER AMPLIFIER vs. SUPPLY VOLTAGE

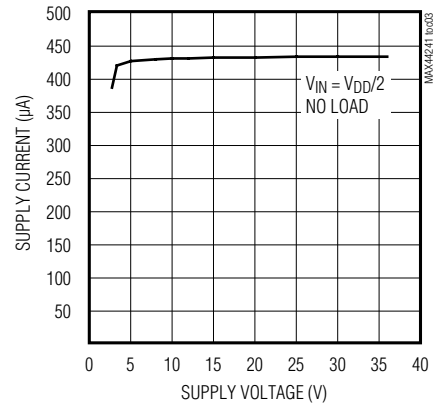

SUPPLY CURRENT PER AMPLIFIER vs. TEMPERATURE

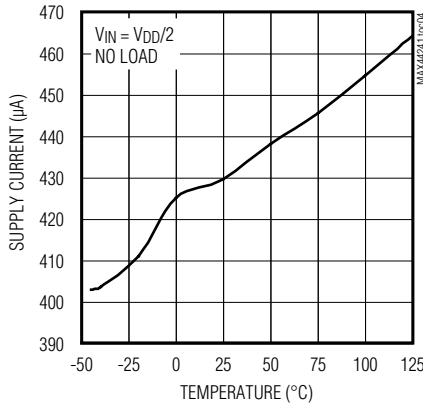

INPUT OFFSET VOLTAGE vs. INPUT COMMON-MODE VOLTAGE

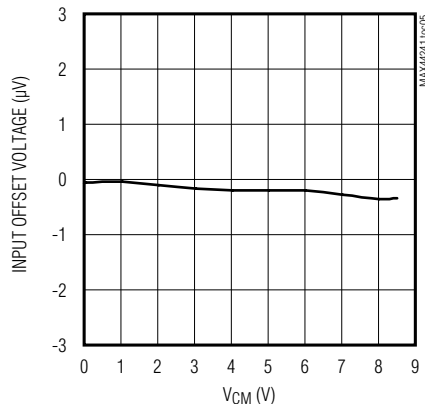

INPUT OFFSET VOLTAGE vs. TEMPERATURE

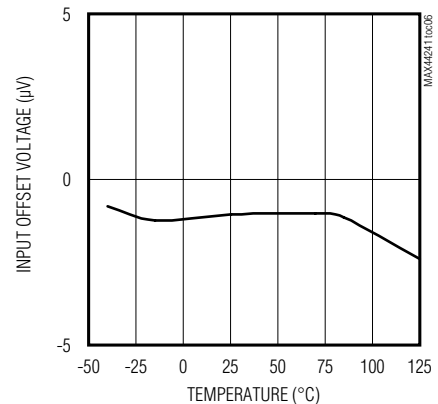

INPUT BIAS CURRENT vs. V_CM vs. TEMPERATURE

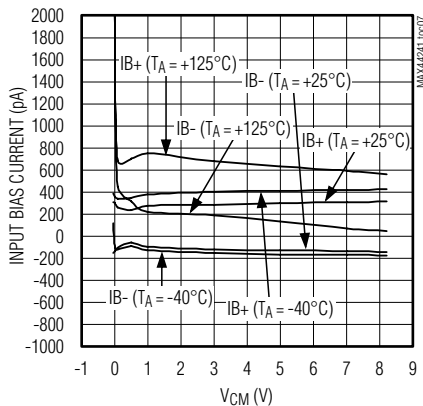

INPUT BIAS CURRENT vs. TEMPERATURE

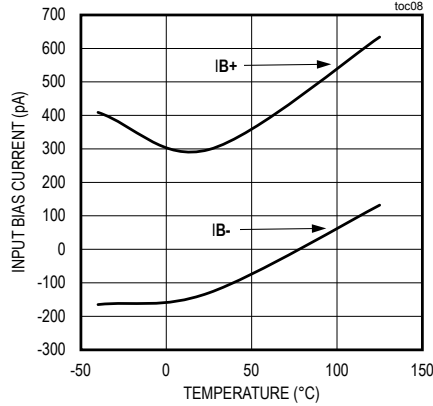

COMMON-MODE REJECTION RATIO vs. TEMPERATURE

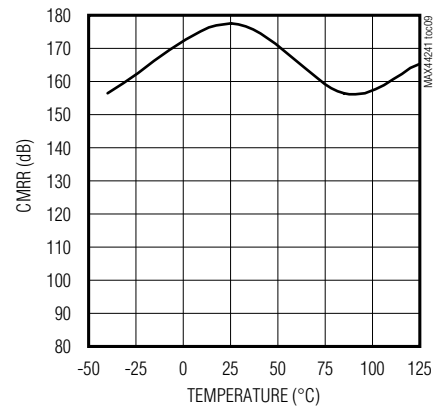

MAX44241/MAX44243/MAX44246

36V, Low-Noise, Precision, Single/Quad/Dual Op Amps

Typical Operating Characteristics (continued)

($V_{DD} = 10V$, $V_{GND} = 0V$, $V_{IN+} = V_{IN-} = V_{DD}/2$, $R_L = 5k\Omega$ to $V_{DD}/2$, $T_A = -40^\circ C$ to $+125^\circ C$, unless otherwise noted. Typical values are at $T_A = +25^\circ C$.) (Note 3)

COMMON-MODE REJECTION RATIO vs. FREQUENCY

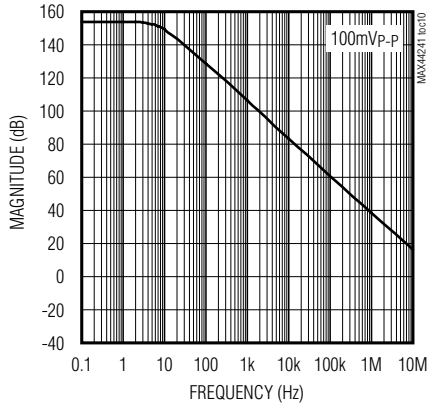

POWER-SUPPLY REJECTION RATIO vs. TEMPERATURE

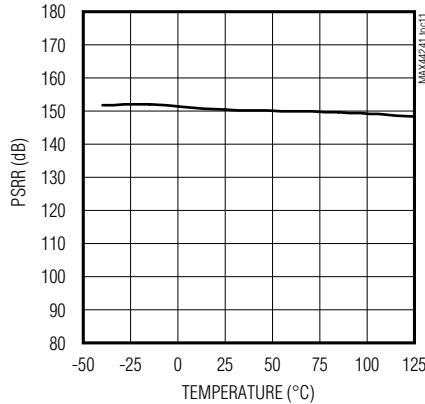

OPEN-LOOP GAIN vs. FREQUENCY

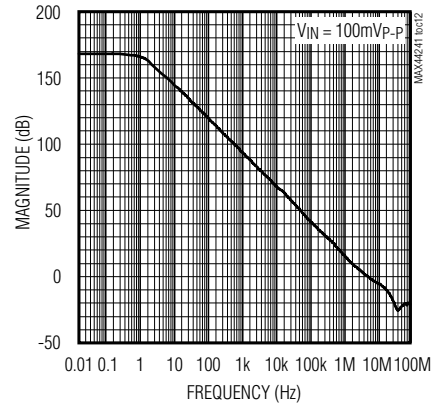

OUTPUT VOLTAGE LOW vs. OUTPUT SINK CURRENT

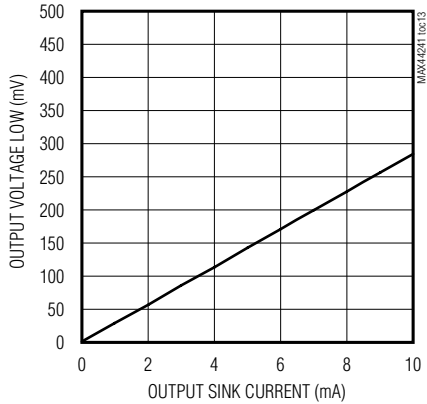

OUTPUT VOLTAGE HIGH vs. OUTPUT SOURCE CURRENT



OUTPUT VOLTAGE LOW vs. TEMPERATURE



OUTPUT VOLTAGE HIGH vs. TEMPERATURE

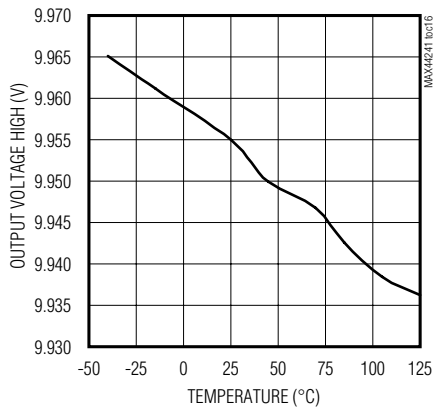

SMALL-SIGNAL GAIN vs. FREQUENCY

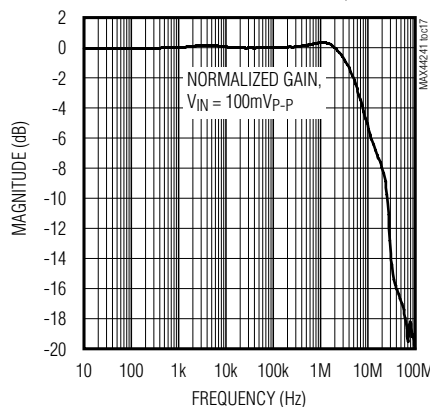

LARGE-SIGNAL GAIN vs. FREQUENCY

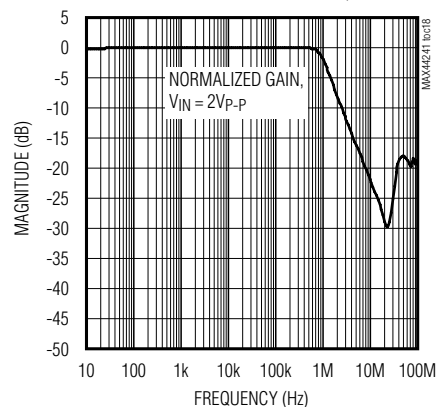

MAX44241/MAX44243/MAX44246

36V, Low-Noise, Precision, Single/Quad/Dual Op Amps

Typical Operating Characteristics (continued)

($V_{DD} = 10V$, $V_{GND} = 0V$, $V_{IN+} = V_{IN-} = V_{DD}/2$, $R_L = 5k\Omega$ to $V_{DD}/2$, $T_A = -40^\circ C$ to $+125^\circ C$, unless otherwise noted. Typical values are at $T_A = +25^\circ C$.) (Note 3)

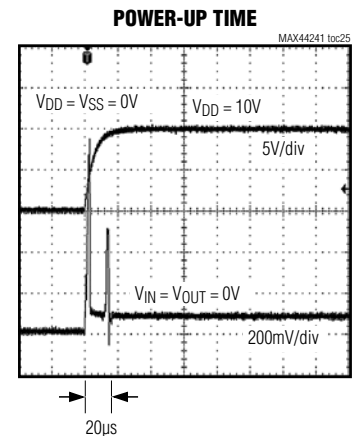
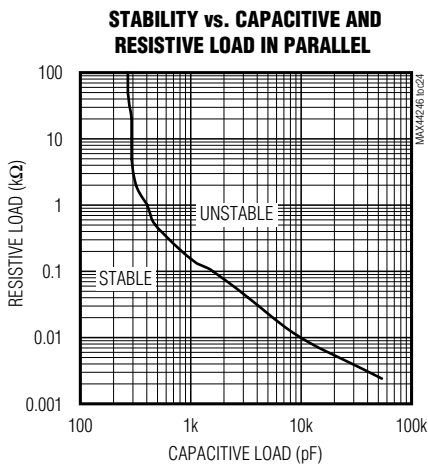
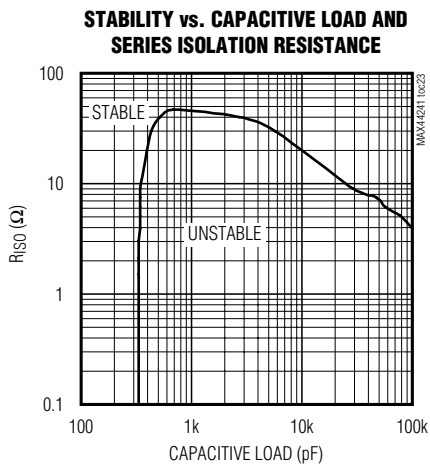
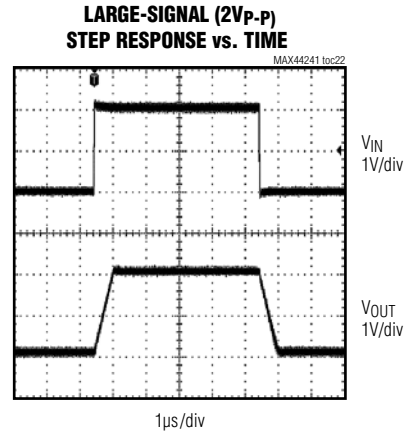
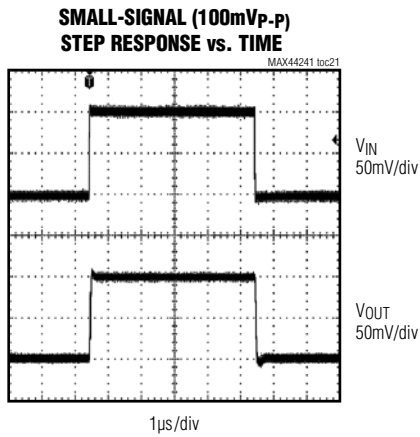
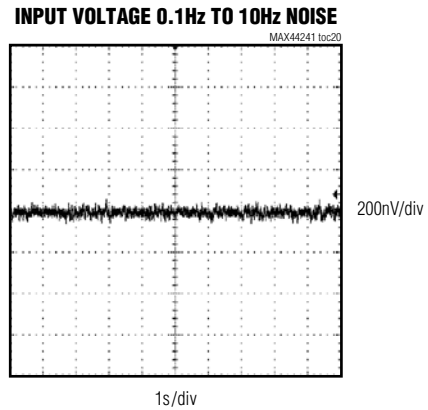
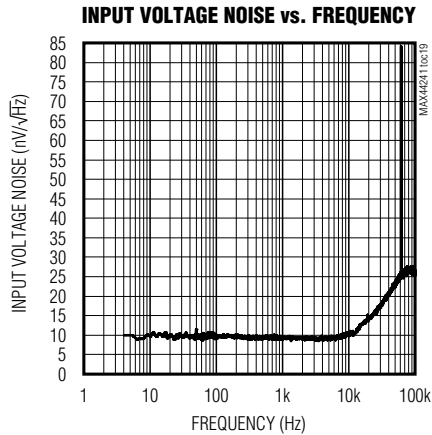

MAX44241/MAX44243/MAX44246

36V, Low-Noise, Precision, Single/Quad/Dual Op Amps

Typical Operating Characteristics (continued)

($V_{DD} = 10V$, $V_{GND} = 0V$, $V_{IN+} = V_{IN-} = V_{DD}/2$, $R_L = 5k\Omega$ to $V_{DD}/2$, $T_A = -40^\circ C$ to $+125^\circ C$, unless otherwise noted. Typical values are at $T_A = +25^\circ C$.) (Note 3)

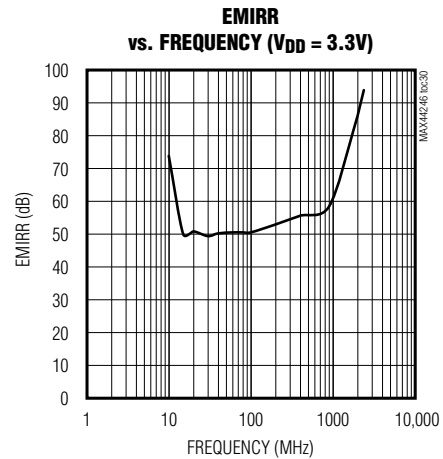
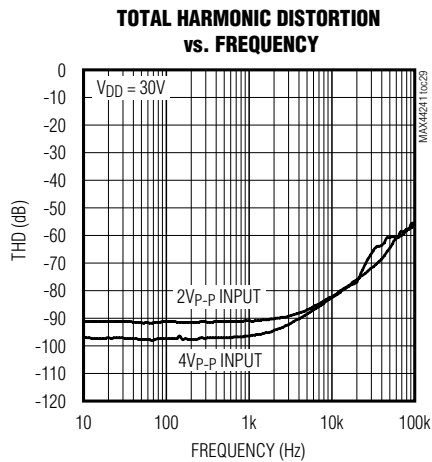
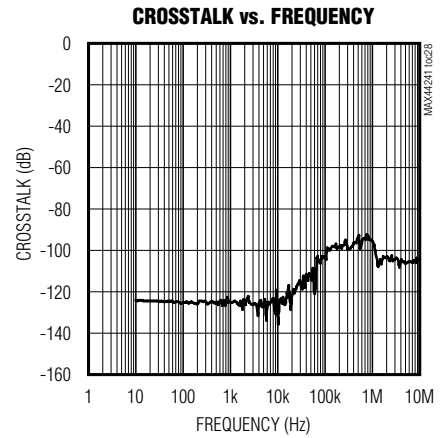
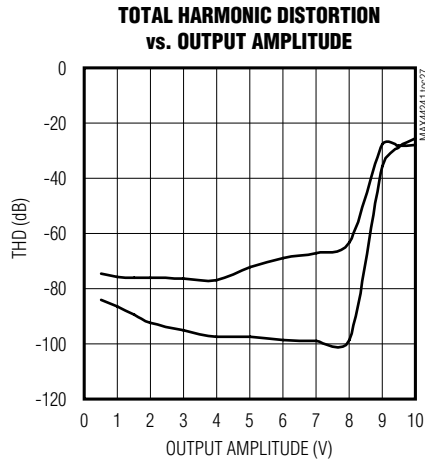
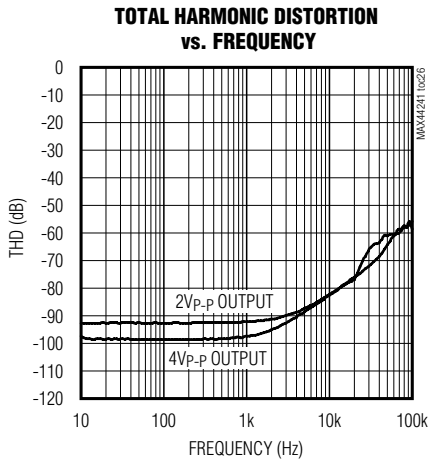

MAX44241/MAX44243/MAX44246

36V, Low-Noise, Precision, Single/Quad/Dual Op Amps

Pin Configurations

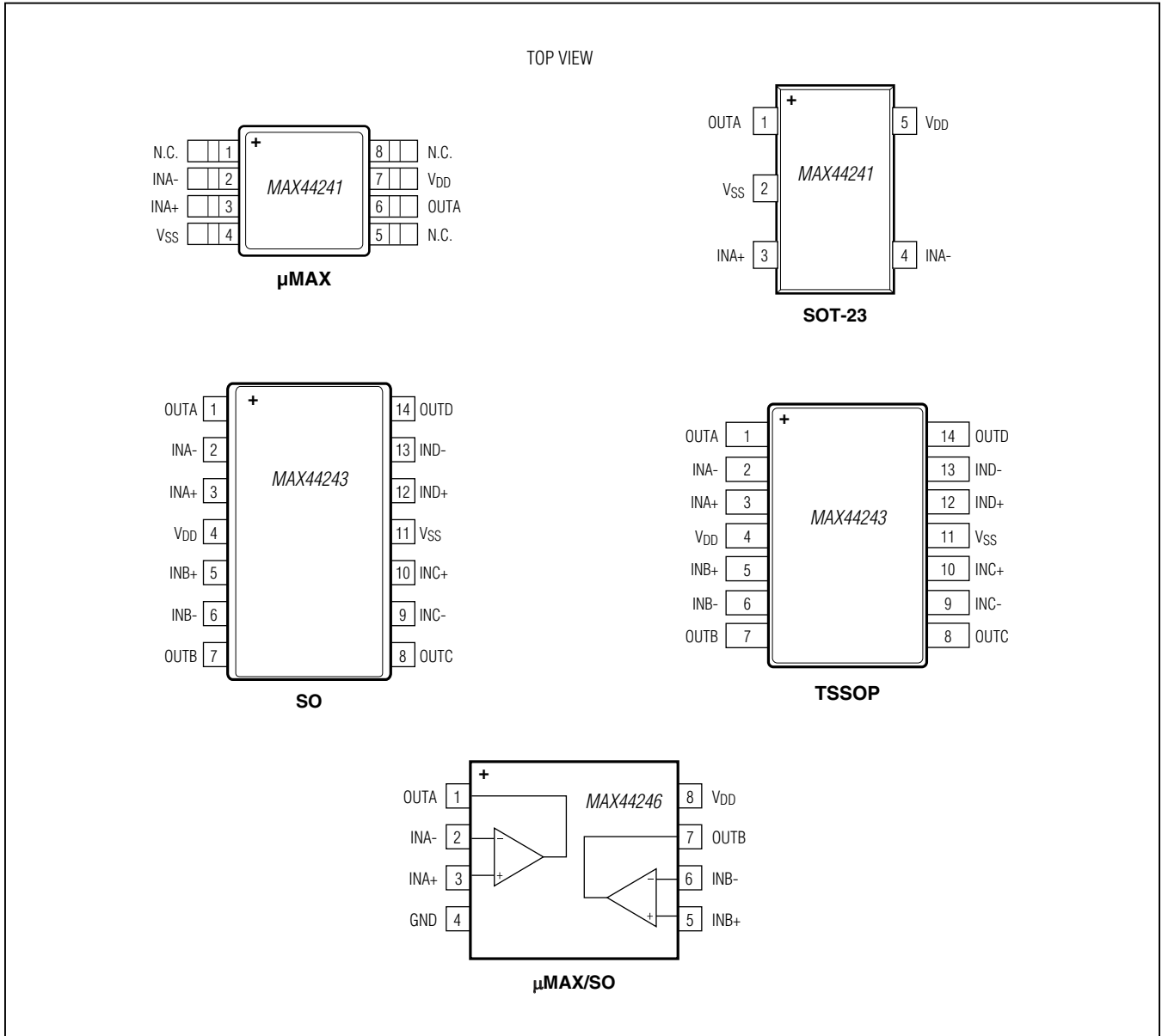

MAX44241/MAX44243/MAX44246

36V, Low-Noise, Precision, Single/Quad/Dual Op Amps

Pin Descriptions

| PIN | | | | | | NAME | FUNCTION |
|----------|---------|----------|----------|----------|--------|-----------------|--|
| MAX44241 | | MAX44243 | | MAX44246 | | | |
| SOT23-5 | μMAX-8 | SO-14 | TSSOP-14 | SO-8 | μMAX-8 | | |
| 1 | 6 | 1 | 1 | 1 | 1 | OUTA | Channel A Output |
| 2 | 4 | 11 | 11 | 4 | 4 | V _{SS} | Negative Supply Voltage |
| 3 | 3 | 3 | 3 | 3 | 3 | INA+ | Channel A Positive Input |
| 4 | 2 | 2 | 2 | 2 | 2 | INA- | Channel A Negative Input |
| 5 | 7 | 4 | 4 | 8 | 8 | V _{DD} | Positive Supply Voltage |
| — | — | 5 | 5 | 5 | 5 | INB+ | Channel B Positive Input |
| — | — | 6 | 6 | 6 | 6 | INB- | Channel B Negative Input |
| — | — | 7 | 7 | 7 | 7 | OUTB | Channel B Output |
| — | — | 8 | 8 | — | — | OUTC | Channel C Output |
| — | — | 9 | 9 | — | — | INC- | Channel C Negative Input |
| — | — | 10 | 10 | — | — | INC+ | Channel C Positive Input |
| — | — | 12 | 12 | — | — | IND+ | Channel D Positive Input |
| — | — | 13 | 13 | — | — | IND- | Channel D Negative Input |
| — | — | 14 | 14 | — | — | OUTD | Channel D Output |
| — | 1, 5, 8 | — | — | — | — | N.C. | No Connection. Not internally connected. |

MAX44241/MAX44243/MAX44246

36V, Low-Noise, Precision, Single/Quad/Dual Op Amps

Detailed Description

The MAX44241/MAX44243/MAX44246 are high-precision amplifiers that provide below 5 μ V of maximum input-referred offset and low flicker noise. These characteristics are achieved by using a combination of proprietary auto-zeroing and chopper stabilized techniques. This combination of auto-zeroing and chopping ensures that these amplifiers give all the benefits of zero-drift amplifiers, while still ensuring low noise, minimizing chopper spikes, and providing wide bandwidth. Offset voltages due to power ripple/spikes as well as common-mode variation, are corrected resulting in excellent PSRR and CMRR specifications.

Noise Suppression

Flicker noise, inherent in all active devices, is inversely proportional to frequency present. Charges at the oxide-silicon interface that are trapped-and-released by MOSFET oxide occurs at low frequency more often. For this reason, flicker noise is also called 1/f noise. The MAX44241/MAX44243/MAX44246 eliminate the 1/f noise internally, thus making them ideal choices for DC or sub-Hz precision applications. The 1/f noise appears as a slow varying offset voltage and is eliminated by the chopping technique used.

Electromagnetic interference (EMI) noise occurs at higher frequency, resulting in malfunction or degradation of electrical equipment. The ICs have an input EMI filter to avoid the output being affected by radio frequency interference. The EMI filter composed of passive devices, presents significant higher impedance to higher frequency.

Applications Information

ADC Buffer Amplifier

The MAX44241/MAX44243/MAX44246 have low input offset voltage, low noise, and fast settling time that make these amplifiers ideal for ADC buffers. Weight scales are one application that often requires a low-noise, high-voltage amplifier in front of an ADC. The *Typical Operating*

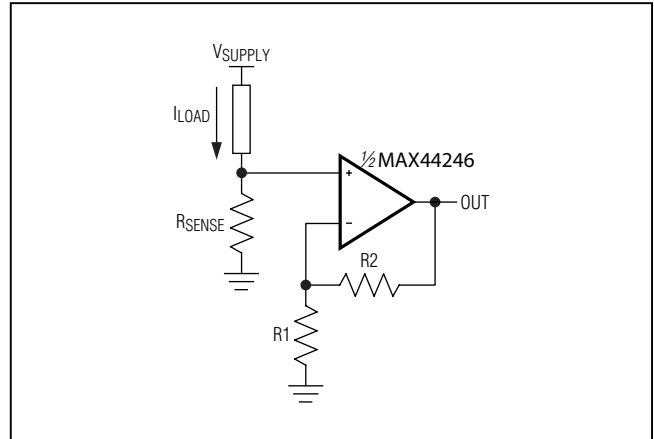

Figure 1. Low-Side Current Sensing

Circuit details an example of a load cell and amplifier driven from the same ± 10 V supplies, along with the MAX11211 18-bit delta sigma ADC. Load cells produce a very small voltage change at their outputs; therefore driving the excitation source with a higher voltage produces a wider dynamic range that can be measured at the ADC inputs.

The MAX11211 ADC operates from a single 2.7V to 3.6V analog supply, offers 18-bit noise-free resolution and 0.86mW power dissipation. The MAX11211 also offers > 100dB rejection at 50Hz and 60Hz. This ADC is part of a family of 16-, 18-, 20-, and 24-bit delta sigma ADCs with high precision and < 1mW power dissipation.

The low input offset voltage and low noise of MAX44241/MAX44243/MAX44246 allow a gain circuit to precede the MAX11211 without losing any dynamic range at the ADC. See the *Typical Operating Circuit*.

Precision Low-Side Current Sensing

The ICs' ultra-low offset voltage and drift make them ideal for precision current-sensing applications. Figure 1 shows the ICs in a low-side current-sense configuration. This circuit produces an accurate output voltage, V_{OUT} equal to $I_{LOAD} \times R_{SENSE} \times (1 + R_2/R_1)$.

MAX44241/MAX44243/MAX44246

36V, Low-Noise, Precision, Single/Quad/Dual Op Amps

Layout Guidelines

The MAX44241/MAX44243/MAX44246 feature ultra-low offset voltage and noise. Therefore, to get optimum performance follow the following layout guidelines.

Avoid temperature gradients at the junction of two dissimilar metals. The most common dissimilar metals used on a PCB are solder-to-component lead and solder-to-board trace. Dissimilar metals create a local thermocouple. A variation in temperature across the board can cause an additional offset due to Seebeck effect at the solder junctions. To minimize the Seebeck effect, place the amplifier away from potential heat sources on the board, if possible. Orient the resistors such that both the ends are heated equally. It is a good practice to match the input signal path to ensure that the type and number of thermoelectric junctions remain the same. For example, consider using dummy 0Ω resistors oriented in such a way that the thermoelectric sources, due to the real resistors in the signal path, are cancelled. It is recommended to flood the PCB with ground plane. The ground plane ensures that heat is distributed uniformly reducing the potential offset voltage degradation due to Seebeck effect.

Ordering Information

| PART | TEMP RANGE | PIN-PACKAGE | TOP MARK |
|----------------------|-----------------|-------------|----------|
| MAX44241 AUA+ | -40°C to +125°C | 8 μMAX | — |
| MAX44241AUK+ | -40°C to +125°C | 5 SOT23 | AFMR |
| MAX44243 ASD+ | -40°C to +125°C | 14 SO | — |
| MAX44243AUD+ | -40°C to +125°C | 14 TSSOP | — |
| MAX44246 ASA+ | -40°C to +125°C | 8 SO | — |
| MAX44246AUA+ | -40°C to +125°C | 8 μMAX | — |

+Denotes a lead(Pb)-free/RoHS-compliant package.

Chip Information

PROCESS: BiCMOS

Package Information

For the latest package outline information and land patterns (footprints), go to www.maximintegrated.com/packages. Note that a "+", "#", or "-" in the package code indicates RoHS status only. Package drawings may show a different suffix character, but the drawing pertains to the package regardless of RoHS status.

| PACKAGE TYPE | PACKAGE CODE | OUTLINE NO. | LAND PATTERN NO. |
|--------------|--------------|-------------------------|-------------------------|
| 5 SOT23 | U5+1 | 21-0057 | 90-0174 |
| 8 SO | S8+4 | 21-0041 | 90-0096 |
| 8 μMAX | U8+1 | 21-0036 | 90-0092 |
| 14 SO | S14M+4 | 21-0041 | 90-0112 |
| 14 TSSOP | U14M+1 | 21-0066 | 90-0113 |

MAX44241/MAX44243/MAX44246

36V, Low-Noise, Precision, Single/Quad/Dual Op Amps

Revision History

| REVISION NUMBER | REVISION DATE | DESCRIPTION | PAGES CHANGED |
|-----------------|---------------|--|---------------|
| 0 | 7/12 | Initial release | — |
| 1 | 9/12 | Revised the <i>Electrical Characteristics</i> and the <i>Typical Operating Characteristics</i> . | 1, 2, 3, 5 |
| 2 | 2/13 | Revised the <i>Typical Operating Characteristics</i> . | 8 |
| 3 | 5/13 | Updated <i>General Description</i> , <i>Typical Application Circuit</i> , and <i>Pin Description</i> . | 1, 9 |
| 4 | 9/13 | Added the MAX44241/MAX44243 to the data sheet. Revised the <i>Typical Operating Circuit</i> . | 1–13 |
| 5 | 1/14 | Revised <i>Electrical Characteristics</i> and the <i>Typical Operating Characteristics</i> . | 2, 5 |



Maxim Integrated cannot assume responsibility for use of any circuitry other than circuitry entirely embodied in a Maxim Integrated product. No circuit patent licenses are implied. Maxim Integrated reserves the right to change the circuitry and specifications without notice at any time. The parametric values (min and max limits) shown in the Electrical Characteristics table are guaranteed. Other parametric values quoted in this data sheet are provided for guidance.