



8/16-bit Atmel XMEGA B1 Microcontroller

ATxmega128B1 / ATxmega64B1

Features

- High-performance, low-power Atmel® AVR® XMEGA® 8/16-bit Microcontroller
- Nonvolatile program and data memories
 - 64K - 128KBytes of in-system self-programmable flash
 - 4K - 8KBytes boot section
 - 2KBytes EEPROM
 - 4K - 8KBytes internal SRAM
- Peripheral Features
 - Two-channel DMA controller
 - Four-channel event system
 - Three 16-bit timer/counters
 - Two timer/counters with 4 output compare or input capture channels
 - One timer/counter with 2 output compare or input capture channels
 - High resolution extensions one timer/counter
 - Advanced waveform extension (AWeX) on one timer/counter
 - Split mode on two timer/counters
 - One USB device interface
 - USB 2.0 full speed (12Mbps) and low speed (1.5Mbps) device compliant
 - 32 Endpoints with full configuration flexibility
 - Two USARTs with IrDA support for one USART
 - AES and DES crypto engine
 - CRC-16 (CRC-CCITT) and CRC-32 (IEEE® 802.3) generator
 - One two-wire interface with dual address match (I²C and SMBus compatible)
 - One serial peripheral interface (SPI)
 - 16-bit Real Time Counter (RTC) with separate oscillator
 - Liquid Crystal Display
 - Up to 4x40 segment driver
 - Built in contrast control
 - ASCII character mapping
 - Flexible SWAP of segment and common terminals buses
 - Two eight-channel, 12-bit, 300 thousand SPS Analog to Digital Converters
 - Four Analog Comparators with window compare function, and current source feature
 - External interrupts on all General Purpose I/O pins
 - Programmable watchdog timer with separate on-chip ultra low power oscillator
 - QTouch® library support
 - Capacitive touch buttons, sliders and wheels
- Special microcontroller features
 - Power-on reset and programmable brown-out detection
 - Internal and external clock options with PLL
 - Programmable multilevel interrupt controller
 - Five sleep modes
 - Programming and debug interfaces
 - JTAG (IEEE 1149.1 Compliant) interface, including boundary scan
 - PDI (Program and Debug Interface)
- I/O and Packages
 - 53 Programmable I/O pins
 - 100-lead TQFP, 100-ball VFBGA
- Operating Voltage
 - 1.6 – 3.6V
- Operating frequency
 - 0 – 12MHz from 1.6V
 - 0 – 32MHz from 2.7V

1. Ordering Information

Ordering Code	Flash (Bytes)	EEPROM (Bytes)	SRAM (Bytes)	Speed (MHz)	Power Supply	Package ⁽¹⁾⁽²⁾⁽³⁾	Temp
ATxmega128B1-AU	128K + 8K	2K	8K	32	1.6 - 3.6V	100A	-40°C - 85°C
ATxmega128B1-AUR ⁽⁴⁾	128K + 8K	2K	8K			7A1	
ATxmega128B1-CU	128K + 8K	2K	8K				
ATxmega128B1-CUR ⁽⁴⁾	128K + 8K	2K	8K				
ATxmega64B1-AU	64K + 4K	2K	4K	32	1.6 - 3.6V	100A	-40°C - 85°C
ATxmega64B1-AUR ⁽⁴⁾	64K + 4K	2K	4K			7A1	
ATxmega64B1-CU	64K + 4K	2K	4K				
ATxmega64B1-CUR ⁽⁴⁾	64K + 4K	2K	4K				

- Notes:
1. This device can also be supplied in wafer form. Please contact your local Atmel sales office for detailed ordering information.
 2. Pb-free packaging, complies to the European Directive for Restriction of Hazardous Substances (RoHS directive). Also Halide free and fully Green.
 3. For packaging information, see "[Errata](#)" on page 134.
 4. Tape and Reel.

Package Type	
100A	100-lead, 14 x 14mm body size, 1.0mm body thickness, 0.5mm lead pitch, thin profile plastic quad flat package (TQFP)
7A1	100-ball (10x10 array), 7 x 7 x 1.0mm body, ball pitch 0.65mm, very thin fine-pitch ball grid array (VFBGA)

Typical Applications

Industrial control	Climate control	Low power battery applications
Factory automation	RF and ZigBee®	Power tools
Building control	USB connectivity	HVAC
Board control	Sensor control	Utility metering
White goods	Optical	Medical applications

2. Pinout/Block Diagram

Figure 2-1. Block diagram and pinout

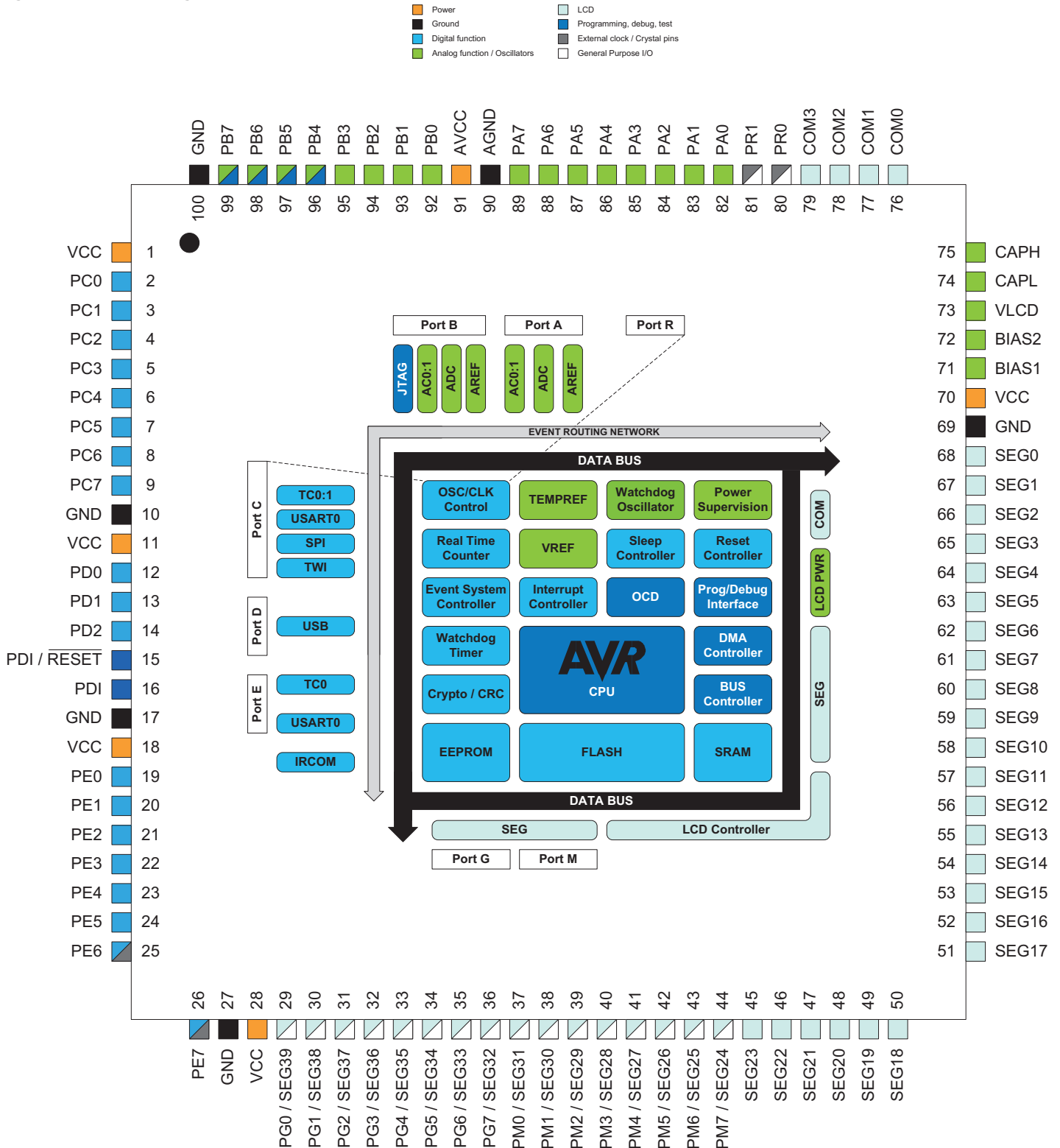

Note: 1. For full details on pinout and alternate pin functions refer to "Pinout and Pin Functions" on page 54.

Figure 2-2. VFBGA-pinout

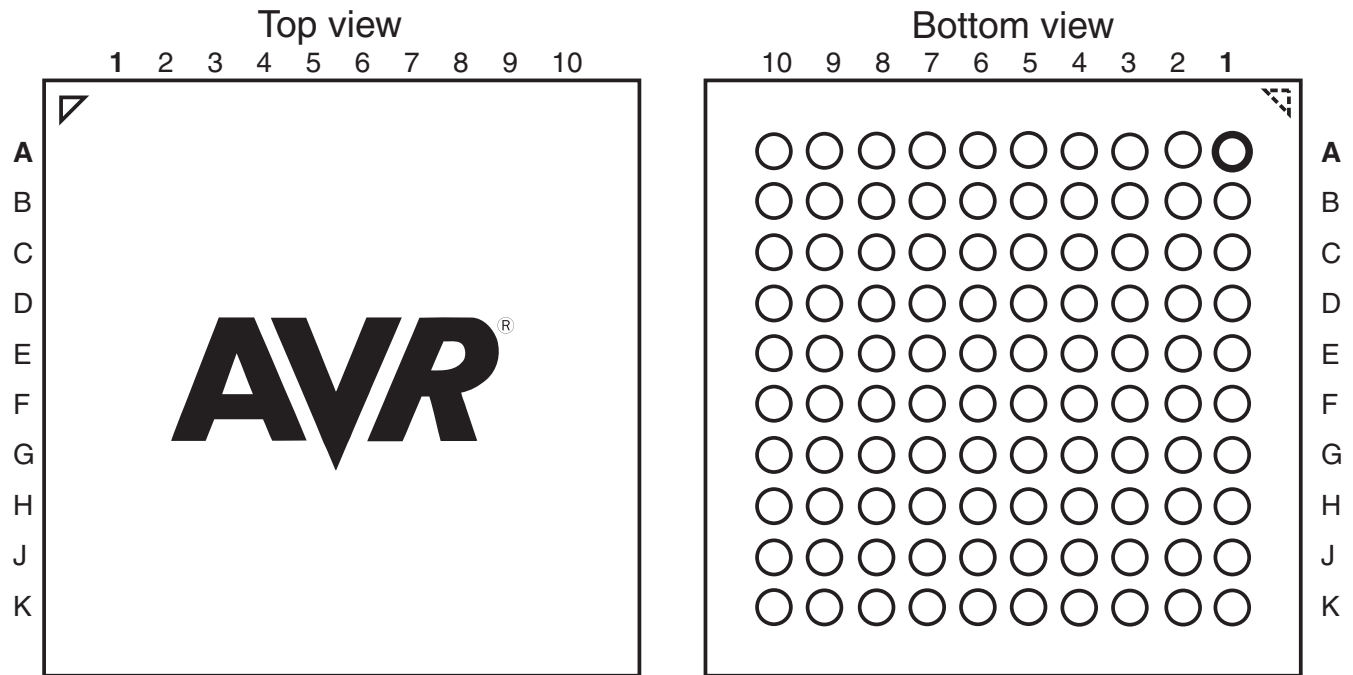

Table 2-1. VFBGA-pinout

	1	2	3	4	5	6	7	8	9	10
A	PC0	VCC	PB6	PB2	AVCC	PA5	PA1	PR1	COM2	CAPH
B	PC3	GND	PB7	PB4	AGND	PA4	PA0	PR0	COM1	CAPL
C	PC5	PC4	PC1	PB5	PA7	PA3	COM3	COM0	VBIAS2	VBIAS1
D	VCC1	GND1	PD0/ UDM	PC2	PB0	PA6	SEG0	VLCD	LGND1	LVCC1
E	PD2	RESET	PD1/ UDP	PC6	PB1	PA2	SEG1	SEG4	SEG3	SEG2
F	VCC	VCC	D2W_D	PC7	PB3	PM2	SEG10	SEG7	SEG6	SEG5
G	PE2	PE1	PE3	PE0	PE4	SEG23	SEG15	SEG13	SEG9	SEG8
H	PE5	PE6	PG1	PG4	PG7	PM5	SEG21	SEG18	SEG12	SEG11
J	PE7	PG0	PG3	PG6	PM1	PM4	PM7	SEG20	SEG16	SEG14
K	LGND01	LVCC01	PG2	PG5	PM0	PM3	PM6	SEG22	SEG19	SEG17

3. Overview

The Atmel® AVR® XMEGA® is a family of low power, high performance, and peripheral rich 8/16-bit microcontrollers based on the AVR enhanced RISC architecture. By executing instructions in a single clock cycle, the Atmel AVR XMEGA devices achieve CPU throughput approaching one million instructions per second (MIPS) per megahertz, allowing the system designer to optimize power consumption versus processing speed.

The AVR CPU combines a rich instruction set with 32 general purpose working registers. All 32 registers are directly connected to the arithmetic logic unit (ALU), allowing two independent registers to be accessed in a single instruction, executed in one clock cycle. The resulting architecture is more code efficient while achieving throughputs many times faster than conventional single-accumulator or CISC based microcontrollers.

The Atmel AVR XMEGA B1 devices provide the following features: in-system programmable flash with read-while-write capabilities; internal EEPROM and SRAM; two-channel DMA controller, four-channel event system and programmable multilevel interrupt controller, 53 general purpose I/O lines, real-time counter (RTC); Liquid Crystal Display supporting up to 4x40 segment driver, ASCII character mapping and built-in contrast control (LCD); three flexible, 16-bit timer/counters with compare and PWM channels; two USARTs; one two-wire serial interface (TWI); one full speed USB 2.0 interface; one serial peripheral interface (SPI); AES and DES cryptographic engine; two 8-channel, 12-bit ADCs with programmable gain; four analog comparators (ACs) with window mode; programmable watchdog timer with separate internal oscillator; accurate internal oscillators with PLL and prescaler; and programmable brown-out detection.

The program and debug interface (PDI), a fast, two-pin interface for programming and debugging, is available. The devices also have an IEEE std. 1149.1 compliant JTAG interface, and this can also be used for on-chip debug and programming.

The ATx devices have five software selectable power saving modes. The idle mode stops the CPU while allowing the SRAM, DMA controller, event system, interrupt controller, and all peripherals to continue functioning. The power-down mode saves the SRAM and register contents, but stops the oscillators, disabling all other functions until the next TWI, USB resume, or pin-change interrupt, or reset. In power-save mode, the asynchronous real-time counter continues to run, allowing the application to maintain a timer base while the rest of the device is sleeping. In power-save mode, the LCD controller is allowed to refresh data to the panel. In standby mode, the external crystal oscillator keeps running while the rest of the device is sleeping. This allows very fast startup from the external crystal, combined with low power consumption. In extended standby mode, both the main oscillator and the asynchronous timer continue to run, and the LCD controller is allowed to refresh data to the panel. To further reduce power consumption, the peripheral clock to each individual peripheral can optionally be stopped in active mode and idle sleep mode.

Atmel offers a free QTouch® library for embedding capacitive touch buttons, sliders and wheels functionality into AVR microcontrollers.

The devices are manufactured using Atmel high-density, nonvolatile memory technology. The program flash memory can be reprogrammed in-system through the PDI or JTAG interfaces. A boot loader running in the device can use any interface to download the application program to the flash memory. The boot loader software in the boot flash section will continue to run while the application flash section is updated, providing true read-while-write operation. By combining an 8/16-bit RISC CPU with in-system, self-programmable flash, the Atmel XMEGA B1 is a powerful microcontroller family that provides a highly flexible and cost effective solution for many embedded applications.

The atmel AVR ATx devices are supported with a full suite of program and system development tools, including C compilers, macro assemblers, program debugger/simulators, programmers, and evaluation kits.

3.1 Block Diagram

Figure 3-1. XMEGA B1 Block Diagram

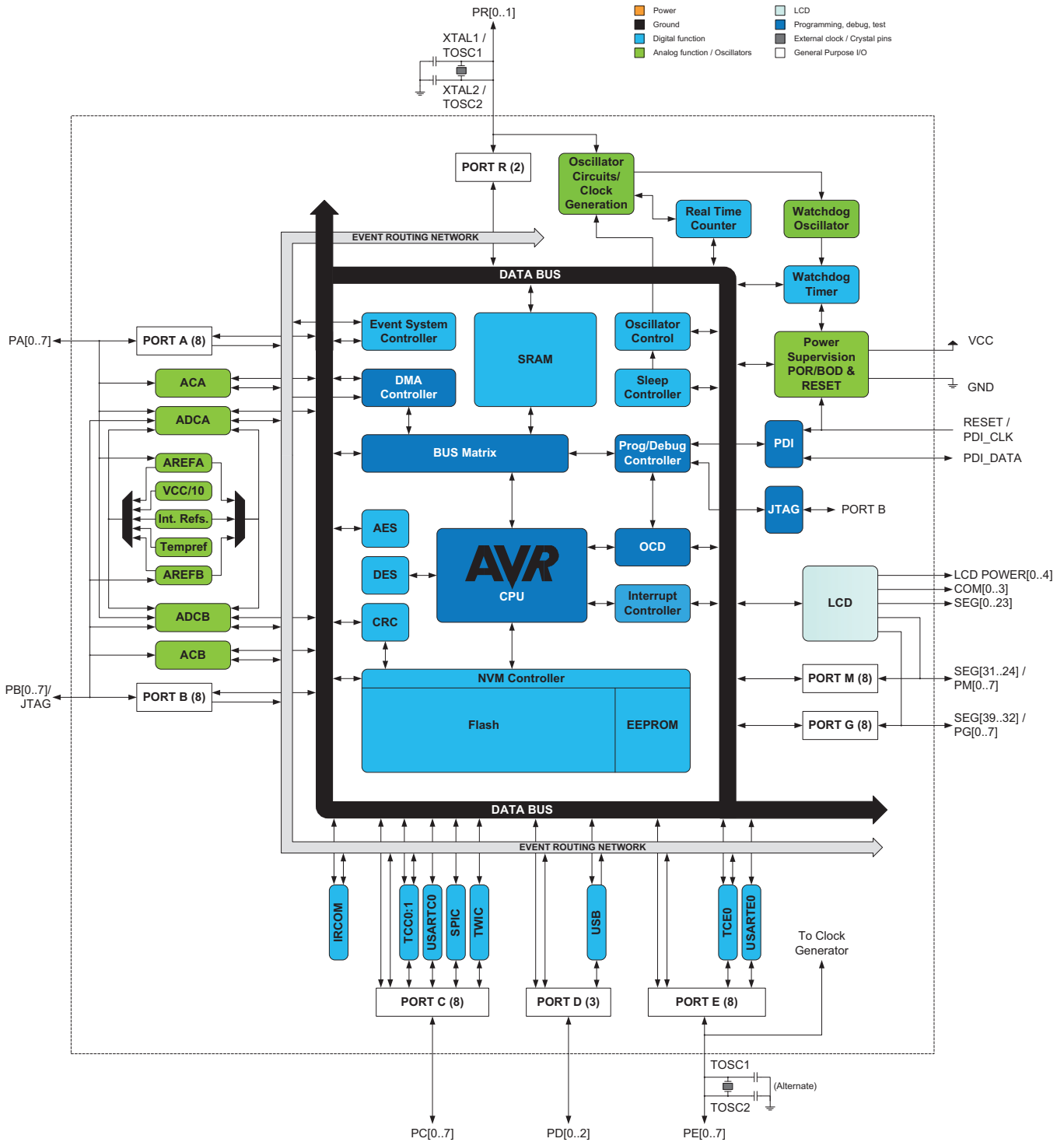

4. Resources

A comprehensive set of development tools, application notes and datasheets are available for download on <http://www.atmel.com/avr>.

4.1 Recommended reading

- XMEGA B Manual
- XMEGA Application Notes

This device data sheet only contains part specific information with a short description of each peripheral and module. The XMEGA B Manual describes the modules and peripherals in depth. The XMEGA application notes contain example code and show applied use of the modules and peripherals.

All documentations are available from www.atmel.com/avr.

5. Capacitive touch sensing

The Atmel QTouch[®] library provides a simple to use solution to realize touch sensitive interfaces on most Atmel AVR microcontrollers. The patented charge-transfer signal acquisition offers robust sensing and includes fully debounced reporting of touch keys and includes Adjacent key suppression[®] (AKS[®]) technology for unambiguous detection of key events. The QTouch library includes support for the QTouch and QMatrix acquisition methods.

Touch sensing can be added to any application by linking the appropriate Atmel QTouch library for the AVR Microcontroller. This is done by using a simple set of APIs to define the touch channels and sensors, and then calling the touch sensing API's to retrieve the channel information and determine the touch sensor states.

The QTouch library is FREE and downloadable from the Atmel website at the following location: www.atmel.com/qtouchlibrary. For implementation details and other information, refer to the [Atmel QTouch library user guide](#) - also available for download from the Atmel website.

6. AVR CPU

6.1 Features

- 8/16-bit, high-performance Atmel AVR RISC CPU
 - 142 instructions
 - Hardware multiplier
- 32x8-bit registers directly connected to the ALU
- Stack in RAM
- Stack pointer accessible in I/O memory space
- Direct addressing of up to 16MB of program memory and 16MB of data memory
- True 16/24-bit access to 16/24-bit I/O registers
- Efficient support for 8-, 16-, and 32-bit arithmetic
- Configuration change protection of system-critical features

6.2 Overview

All AVR XMEGA devices use the 8/16-bit AVR CPU. The main function of the CPU is to execute the code and perform all calculations. The CPU is able to access memories, perform calculations, control peripherals, and execute the program in the flash memory. Interrupt handling is described in a separate section, refer to “[Interrupts and Programmable Multilevel Interrupt Controller](#)” on page 28.

6.3 Architectural Overview

In order to maximize performance and parallelism, the AVR CPU uses a Harvard architecture with separate memories and buses for program and data. Instructions in the program memory are executed with single-level pipelining. While one instruction is being executed, the next instruction is pre-fetched from the program memory. This enables instructions to be executed on every clock cycle. For details of all AVR instructions, refer to <http://www.atmel.com/avr>.

Figure 6-1. Block Diagram of the AVR CPU architecture.

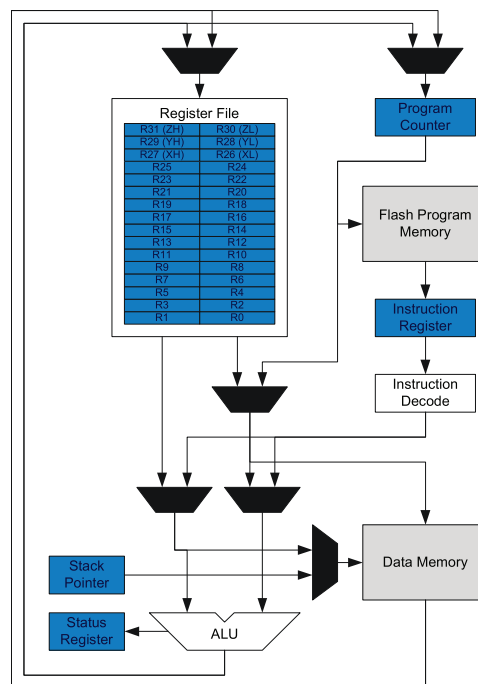

The arithmetic logic unit (ALU) supports arithmetic and logic operations between registers or between a constant and a register. Single-register operations can also be executed in the ALU. After an arithmetic operation, the status register is updated to reflect information about the result of the operation.

The ALU is directly connected to the fast-access register file. The 32 x 8-bit general purpose working registers all have single clock cycle access time allowing single-cycle arithmetic logic unit (ALU) operation between registers or between a register and an immediate. Six of the 32 registers can be used as three 16-bit address pointers for program and data space addressing, enabling efficient address calculations.

The memory spaces are linear. The data memory space and the program memory space are two different memory spaces.

The data memory space is divided into I/O registers and SRAM. In addition, the EEPROM can be memory mapped in the data memory.

All I/O status and control registers reside in the lowest 4KB addresses of the data memory. This is referred to as the I/O memory space. The lowest 64 addresses can be accessed directly, or as the data space locations from 0x00 to 0x3F. The rest is the extended I/O memory space, ranging from 0x0040 to 0x0FFF. I/O registers here must be accessed as data space locations using load (LD/LDS/LDD) and store (ST/STS/STD) instructions.

The SRAM holds data. Code execution from SRAM is not supported. It can easily be accessed through the five different addressing modes supported in the AVR architecture. The first SRAM address is 0x2000.

Data addresses 0x1000 to 0x1FFF are reserved for memory mapping of EEPROM.

The program memory is divided in two sections, the application program section and the boot program section. Both sections have dedicated lock bits for write and read/write protection. The SPM instruction that is used for self-programming of the application flash memory must reside in the boot program section. The application section contains an application table section with separate lock bits for write and read/write protection. The application table section can be used for save storing of nonvolatile data in the program memory.

6.4 ALU - Arithmetic Logic Unit

The arithmetic logic unit (ALU) supports arithmetic and logic operations between registers or between a constant and a register. Single-register operations can also be executed. The ALU operates in direct connection with all 32 general purpose registers. In a single clock cycle, arithmetic operations between general purpose registers or between a register and an immediate are executed and the result is stored in the register file. After an arithmetic or logic operation, the status register is updated to reflect information about the result of the operation.

ALU operations are divided into three main categories – arithmetic, logical, and bit functions. Both 8- and 16-bit arithmetic is supported, and the instruction set allows for efficient implementation of 32-bit arithmetic. The hardware multiplier supports signed and unsigned multiplication and fractional format.

6.4.1 Hardware Multiplier

The multiplier is capable of multiplying two 8-bit numbers into a 16-bit result. The hardware multiplier supports different variations of signed and unsigned integer and fractional numbers:

- Multiplication of unsigned integers
- Multiplication of signed integers
- Multiplication of a signed integer with an unsigned integer
- Multiplication of unsigned fractional numbers
- Multiplication of signed fractional numbers
- Multiplication of a signed fractional number with an unsigned one

A multiplication takes two CPU clock cycles.

6.5 Program Flow

After reset, the CPU starts to execute instructions from the lowest address in the flash program memory '0.' The program counter (PC) addresses the next instruction to be fetched.

Program flow is provided by conditional and unconditional jump and call instructions capable of addressing the whole address space directly. Most AVR instructions use a 16-bit word format, while a limited number use a 32-bit format.

During interrupts and subroutine calls, the return address PC is stored on the stack. The stack is allocated in the general data SRAM, and consequently the stack size is only limited by the total SRAM size and the usage of the SRAM. After reset, the stack pointer (SP) points to the highest address in the internal SRAM. The SP is read/write accessible in the I/O memory space, enabling easy implementation of multiple stacks or stack areas. The data SRAM can easily be accessed through the five different addressing modes supported in the AVR CPU.

6.6 Status Register

The status register (SREG) contains information about the result of the most recently executed arithmetic or logic instruction. This information can be used for altering program flow in order to perform conditional operations. Note that the status register is updated after all ALU operations, as specified in the instruction set reference. This will in many cases remove the need for using the dedicated compare instructions, resulting in faster and more compact code.

The status register is not automatically stored when entering an interrupt routine nor restored when returning from an interrupt. This must be handled by software.

The status register is accessible in the I/O memory space.

6.7 Stack and Stack Pointer

The stack is used for storing return addresses after interrupts and subroutine calls. It can also be used for storing temporary data. The stack pointer (SP) register always points to the top of the stack. It is implemented as two 8-bit registers that are accessible in the I/O memory space. Data are pushed and popped from the stack using the PUSH and POP instructions. The stack grows from a higher memory location to a lower memory location. This implies that pushing data onto the stack decreases the SP, and popping data off the stack increases the SP. The SP is automatically loaded after reset, and the initial value is the highest address of the internal SRAM. If the SP is changed, it must be set to point above address 0x2000, and it must be defined before any subroutine calls are executed or before interrupts are enabled.

During interrupts or subroutine calls, the return address is automatically pushed on the stack. The return address can be two or three bytes, depending on program memory size of the device. For devices with 128KB or less of program memory, the return address is two bytes, and hence the stack pointer is decremented/incremented by two. For devices with more than 128KB of program memory, the return address is three bytes, and hence the SP is decremented/incremented by three. The return address is popped off the stack when returning from interrupts using the RETI instruction, and from subroutine calls using the RET instruction.

The SP is decremented by one when data are pushed on the stack with the PUSH instruction, and incremented by one when data is popped off the stack using the POP instruction.

To prevent corruption when updating the stack pointer from software, a write to SPL will automatically disable interrupts for up to four instructions or until the next I/O memory write.

6.8 Register File

The register file consists of 32 x 8-bit general purpose working registers with single clock cycle access time. The register file supports the following input/output schemes:

- One 8-bit output operand and one 8-bit result input
- Two 8-bit output operands and one 8-bit result input
- Two 8-bit output operands and one 16-bit result input
- One 16-bit output operand and one 16-bit result input

Six of the 32 registers can be used as three 16-bit address register pointers for data space addressing, enabling efficient address calculations. One of these address pointers can also be used as an address pointer for lookup tables in flash program memory.

7. Memories

7.1 Features

- Flash program memory
 - One linear address space
 - In-system programmable
 - Self-programming and boot loader support
 - Application section for application code
 - Application table section for application code or data storage
 - Boot section for application code or boot loader code
 - Separate read/write protection lock bits for all sections
 - Built in fast CRC check of a selectable flash program memory section
- Data memory
 - One linear address space
 - Single-cycle access from CPU
 - SRAM
 - EEPROM
 - Byte and page accessible
 - Optional memory mapping for direct load and store
 - I/O memory
 - Configuration and status registers for all peripherals and modules
 - 4 bit-accessible general purpose registers for global variables or flags
 - Bus arbitration
 - Safe and deterministic handling of priority between CPU, DMA controller, and other bus masters
 - Separate buses for SRAM, EEPROM and I/O memory
 - Simultaneous bus access for CPU and DMA controller
- Production signature row memory for factory programmed data
 - ID for each microcontroller device type
 - Serial number for each device
 - Calibration bytes for factory calibrated peripherals
- User signature row
 - One flash page in size
 - Can be read and written from software
 - Content is kept after chip erase

7.2 Overview

The Atmel AVR architecture has two main memory spaces, the program memory and the data memory. Executable code can reside only in the program memory, while data can be stored in the program memory and the data memory. The data memory includes the internal SRAM, and EEPROM for nonvolatile data storage. All memory spaces are linear and require no memory bank switching. Nonvolatile memory (NVM) spaces can be locked for further write and read/write operations. This prevents unrestricted access to the application software.

A separate memory section contains the fuse bytes. These are used for configuring important system functions, and can only be written by an external programmer.

The available memory size configurations are shown in [“Ordering Information” on page 2](#). In addition, each device has a Flash memory signature row for calibration data, device identification, serial number etc.

7.3 Flash Program Memory

The Atmel AVR XMEGA devices contain on-chip, in-system reprogrammable flash memory for program storage. The flash memory can be accessed for read and write from an external programmer through the PDI or from application software running in the device.

All AVR CPU instructions are 16 or 32 bits wide, and each flash location is 16 bits wide. The flash memory is organized in two main sections, the application section and the boot loader section. The sizes of the different sections are fixed, but device-dependent. These two sections have separate lock bits, and can have different levels of protection. The store program memory (SPM) instruction, which is used to write to the flash from the application software, will only operate when executed from the boot loader section.

The application section contains an application table section with separate lock settings. This enables safe storage of nonvolatile data in the program memory.

Figure 7-1. Flash program memory (Hexadecimal address).

Word Address		
ATxmega128B1	ATxmega64B1	
0	0	Application section (bytes) (128K/64K)
		...
EFFF /	77FF	
F000 /	7800	Application table section (bytes) (8K/4K)
FFFF /	7FFF	
10000 /	8000	Boot section (bytes) (8K/4K)
10FFF /	87FF	

7.3.1 Application Section

The Application section is the section of the flash that is used for storing the executable application code. The protection level for the application section can be selected by the boot lock bits for this section. The application section can not store any boot loader code since the SPM instruction cannot be executed from the application section.

7.3.2 Application Table Section

The application table section is a part of the application section of the flash memory that can be used for storing data. The size is identical to the boot loader section. The protection level for the application table section can be selected by the boot lock bits for this section. The possibilities for different protection levels on the application section and the application table section enable safe parameter storage in the program memory. If this section is not used for data, application code can reside here.

7.3.3 Boot Loader Section

While the application section is used for storing the application code, the boot loader software must be located in the boot loader section because the SPM instruction can only initiate programming when executing from this section. The SPM instruction can access the entire flash, including the boot loader section itself. The protection level for the boot loader section can be selected by the boot loader lock bits. If this section is not used for boot loader software, application code can be stored here.

7.3.4 Production Signature Row

The production signature row is a separate memory section for factory programmed data. It contains calibration data for functions such as oscillators and analog modules. Some of the calibration values will be automatically loaded to the corresponding module or peripheral unit during reset. Other values must be loaded from the signature row and written to the corresponding peripheral registers from software. For details on calibration conditions, refer to “[Electrical Characteristics](#)” on page 70.

The production signature row also contains an ID that identifies each microcontroller device type and a serial number for each manufactured device. The serial number consists of the production lot number, wafer number, and wafer coordinates for the device. The device ID for the available devices is shown in [Table 7-1 on page 14](#).

The production signature row cannot be written or erased, but it can be read from application software and external programmers.

Table 7-1. Device ID bytes for XMEGA B1 devices.

Device	Device ID bytes		
	Byte 2	Byte 1	Byte 0
ATxmega64B1	52	96	1E
ATxmega128B1	4D	97	1E

7.3.5 User Signature Row

The user signature row is a separate memory section that is fully accessible (read and write) from application software and external programmers. It is one flash page in size, and is meant for static user parameter storage, such as calibration data, custom serial number, identification numbers, random number seeds, etc. This section is not erased by chip erase commands that erase the flash, and requires a dedicated erase command. This ensures parameter storage during multiple program/erase operations and on-chip debug sessions.

7.4 Fuses and Lock bits

The fuses are used to configure important system functions, and can only be written from an external programmer. The application software can read the fuses. The fuses are used to configure reset sources such as brownout detector and watchdog, startup configuration, JTAG enable, and JTAG user ID.

The lock bits are used to set protection levels for the different flash sections (i.e., if read and/or write access should be blocked). Lock bits can be written by external programmers and application software, but only to stricter protection levels. Chip erase is the only way to erase the lock bits. To ensure that flash contents are protected even during chip erase, the lock bits are erased after the rest of the flash memory has been erased.

An unprogrammed fuse or lock bit will have the value one, while a programmed fuse or lock bit will have the value zero. Both fuses and lock bits are reprogrammable like the flash program memory.

7.5 Data Memory

The data memory contains the I/O memory, internal SRAM and optionally memory mapped EEPROM. The data memory is organized as one continuous memory section, see [Figure 7-2 on page 15](#). To simplify development, I/O Memory, EEPROM and SRAM will always have the same start addresses for all XMEGA devices.

Figure 7-2. Data memory map (hexadecimal address).

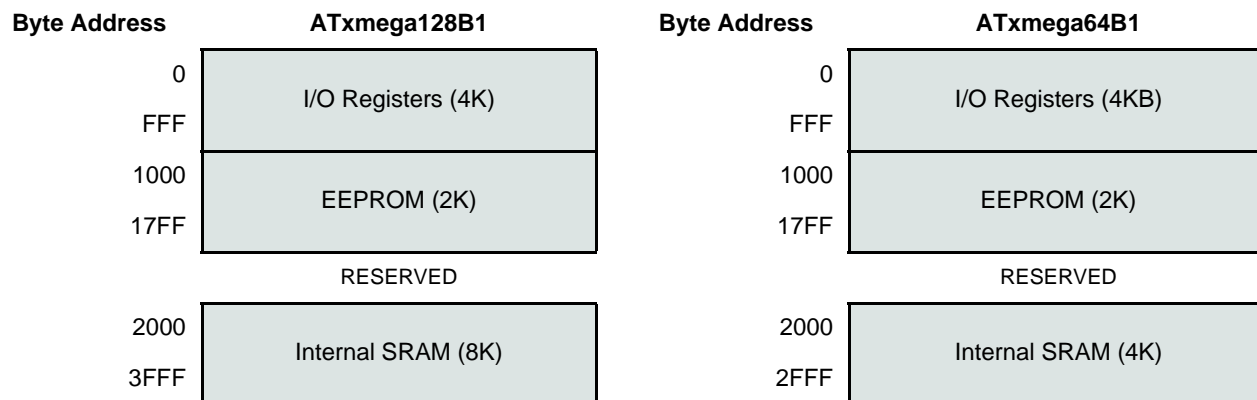

7.6 EEPROM

XMEGA B1 devices have EEPROM for nonvolatile data storage. It is either addressable in a separate data space (default) or memory mapped and accessed in normal data space. The EEPROM supports both byte and page access. Memory mapped EEPROM allows highly efficient EEPROM reading and EEPROM buffer loading. When doing this, EEPROM is accessible using load and store instructions. Memory mapped EEPROM will always start at hexadecimal address 0x1000.

7.7 I/O Memory

The status and configuration registers for peripherals and modules, including the CPU, are addressable through I/O memory locations. All I/O locations can be accessed by the load (LD/LDS/LDD) and store (ST/STS/STD) instructions, which are used to transfer data between the 32 registers in the register file and the I/O memory. The IN and OUT instructions can address I/O memory locations in the range of 0x00 to 0x3F directly. In the address range 0x00 - 0x1F, single-cycle instructions for manipulation and checking of individual bits are available.

The I/O memory address for all peripherals and modules in XMEGA B1 is shown in the [“Peripheral Module Address Map” on page 61](#).

7.7.1 General Purpose I/O Registers

The lowest 4 I/O memory addresses are reserved as general purpose I/O registers. These registers can be used for storing global variables and flags, as they are directly bit-accessible using the SBI, CBI, SBIS, and SBIC instructions.

7.8 Data Memory and Bus Arbitration

Since the data memory is organized as four separate sets of memories, the different bus masters (CPU, DMA controller read and DMA controller write, etc.) can access different memory sections at the same time.

7.9 Memory Timing

Read and write access to the I/O memory takes one CPU clock cycle. A write to SRAM takes one cycle, and a read from SRAM takes two cycles. For burst read (DMA), new data are available every cycle. EEPROM page load (write) takes one cycle, and three cycles are required for read. For burst read, new data are available every second cycle. Refer to the instruction summary for more details on instructions and instruction timing.

7.10 Device ID and Revision

Each device has a three-byte device ID. This ID identifies Atmel as the manufacturer of the device and the device type. A separate register contains the revision number of the device.

7.11 JTAG Disable

It is possible to disable the JTAG interface from the application software. This will prevent all external JTAG access to the device until the next device reset or until JTAG is enabled again from the application software. As long as JTAG is disabled, the I/O pins required for JTAG can be used as normal I/O pins.

7.12 I/O Memory Protection

Some features in the device are regarded as critical for safety in some applications. Due to this, it is possible to lock the I/O register related to the clock system, the event system, and the advanced waveform extensions. As long as the lock is enabled, all related I/O registers are locked and they can not be written from the application software. The lock registers themselves are protected by the configuration change protection mechanism.

7.13 Flash and EEPROM Page Size

The flash program memory and EEPROM data memory are organized in pages. The pages are word accessible for the flash and byte accessible for the EEPROM.

Table 7-2 on page 16 shows the Flash Program Memory organization. Flash write and erase operations are performed on one page at a time, while reading the Flash is done one byte at a time. For Flash access the Z-pointer (Z[m:n]) is used for addressing. The most significant bits in the address (FPAGE) give the page number and the least significant address bits (FWORD) give the word in the page.

Table 7-2. Number of words and Pages in the Flash.

Devices	PC size	Flash	Page Size	FWORD	FPAGE	Application		Boot	
	bits	bytes	words			Size	No of pages	Size	No of pages
ATxmega64B1	16	64K + 4K	128	Z[7:1]	Z[16:8]	64K	256	4K	16
ATxmega128B1	17	128K + 8K	128	Z[8:1]	Z[17:9]	128K	512	8K	32

Table 7-3 on page 16 shows EEPROM memory organization for the XMEGA B1 devices. EEPROM write and erase operations can be performed one page or one byte at a time, while reading the EEPROM is done one byte at a time. For EEPROM access the NVM address register (ADDR[m:n]) is used for addressing. The most significant bits in the address (E2PAGE) give the page number and the least significant address bits (E2BYTE) give the byte in the page.

Table 7-3. Number of Bytes and Pages in the EEPROM.

Devices	EEPROM	Page Size	E2BYTE	E2PAGE	No of Pages
	Size	bytes			
ATxmega64B1	2K	32	ADDR[4:0]	ADDR[10:5]	64
ATxmega128B1	2K	32	ADDR[4:0]	ADDR[10:5]	64

8. DMAC – Direct Memory Access Controller

8.1 Features

- Allows high speed data transfers with minimal CPU intervention
 - from data memory to data memory
 - from data memory to peripheral
 - from peripheral to data memory
 - from peripheral to peripheral
- Two DMA channels with separate
 - transfer triggers
 - interrupt vectors
 - addressing modes
- Programmable channel priority
- From 1 byte to 16MB of data in a single transaction
 - Up to 64KB block transfers with repeat
 - 1, 2, 4, or 8 byte burst transfers
- Multiple addressing modes
 - Static
 - Incremental
 - Decremental
- Optional reload of source and destination addresses at the end of each
 - Burst
 - Block
 - Transaction
- Optional interrupt on end of transaction
- Optional connection to CRC generator for CRC on DMA data

8.2 Overview

The two-channel direct memory access (DMA) controller can transfer data between memories and peripherals, and thus offload these tasks from the CPU. It enables high data transfer rates with minimum CPU intervention, and frees up CPU time. The four DMA channels enable up to four independent and parallel transfers.

The DMA controller can move data between SRAM and peripherals, between SRAM locations and directly between peripheral registers. With access to all peripherals, the DMA controller can handle automatic transfer of data to/from communication modules. The DMA controller can also read from memory mapped EEPROM.

Data transfers are done in continuous bursts of 1, 2, 4, or 8 bytes. They build block transfers of configurable size from 1 byte to 64KB. A repeat counter can be used to repeat each block transfer for single transactions up to 16MB. Source and destination addressing can be static, incremental or decremental. Automatic reload of source and/or destination addresses can be done after each burst or block transfer, or when a transaction is complete. Application software, peripherals, and events can trigger DMA transfers.

The two DMA channels have individual configuration and control settings. This include source, destination, transfer triggers, and transaction sizes. They have individual interrupt settings. Interrupt requests can be generated when a transaction is complete or when the DMA controller detects an error on a DMA channel.

To allow for continuous transfers, the channels can be interlinked so that the second takes over the transfer when the first is finished, and vice versa.

9. Event System

9.1 Features

- System for direct peripheral-to-peripheral communication and signaling
- Peripherals can directly send, receive, and react to peripheral events
 - CPU and DMA controller independent operation
 - 100% predictable signal timing
 - Short and guaranteed response time
- Four event channels for up to four different and parallel signal routings and configurations
- Events can be sent and/or used by most peripherals, clock system, and software
- Additional functions include
 - Quadrature decoders
 - Digital filtering of I/O pin state
- Works in active mode and idle sleep mode

9.2 Overview

The event system enables direct peripheral-to-peripheral communication and signaling. It allows a change in one peripheral's state to automatically trigger actions in other peripherals. It is designed to provide a predictable system for short and predictable response times between peripherals. It allows for autonomous peripheral control and interaction without the use of interrupts, CPU, or DMA controller resources, and is thus a powerful tool for reducing the complexity, size and execution time of application code. It also allows for synchronized timing of actions in several peripheral modules.

A change in a peripheral's state is referred to as an event, and usually corresponds to the peripheral's interrupt conditions. Events can be directly passed to other peripherals using a dedicated routing network called the event routing network. How events are routed and used by the peripherals is configured in software.

[Figure 9-1 on page 19](#) shows a basic diagram of all connected peripherals. The event system can directly connect together analog and digital converters, analog comparators, I/O port pins, the real-time counter, timer/counters, IR communication module (IRCOM), and USB interface. It can also be used to trigger DMA transactions (DMA controller). Events can also be generated from software and the peripheral clock.

Figure 9-1. Event system overview and connected peripherals.

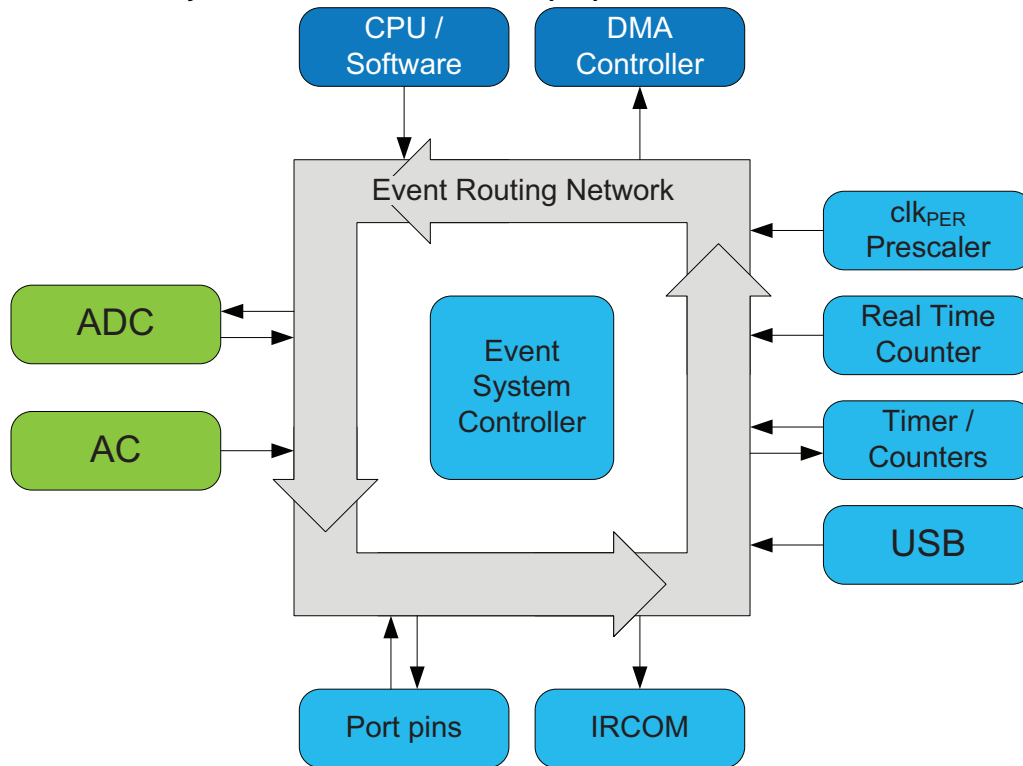

The event routing network consists of four software-configurable multiplexers that control how events are routed and used. These are called event channels, and allow for up to four parallel event configurations and routings. The maximum routing latency is two peripheral clock cycles. The event system works in both active mode and idle sleep mode.

10. System Clock and Clock options

10.1 Features

- Fast start-up time
- Safe run-time clock switching
- Internal oscillators:
 - 32MHz run-time calibrated oscillator
 - 2MHz run-time calibrated oscillator
 - 32.768kHz calibrated oscillator
 - 32kHz ultra low power (ULP) oscillator with 1kHz output
- External clock options
 - 0.4MHz - 16MHz crystal oscillator
 - 32.768kHz crystal oscillator
 - External clock
- PLL with 20MHz - 128MHz output frequency
 - Internal and external clock options and 1x to 31x multiplication
 - Lock detector
- Clock prescalers with 1x to 2048x division
- Fast peripheral clocks running at 2 and 4 times the CPU clock
- Automatic run-time calibration of internal oscillators
- External oscillator and PLL lock failure detection with optional non-maskable interrupt

10.2 Overview

Atmel AVR XMEGA devices have a flexible clock system supporting a large number of clock sources. It incorporates both accurate internal oscillators and external crystal oscillator and resonator support. A high-frequency phase locked loop (PLL) and clock prescalers can be used to generate a wide range of clock frequencies. A calibration feature (DFLL) is available, and can be used for automatic run-time calibration of the internal oscillators to remove frequency drift over voltage and temperature. An oscillator failure monitor can be enabled to issue a non-maskable interrupt and switch to the internal oscillator if the external oscillator or PLL fails.

When a reset occurs, all clock sources except the 32kHz ultra low power oscillator are disabled. After reset, the device will always start up running from the 2MHz internal oscillator. During normal operation, the system clock source and prescalers can be changed from software at any time.

[Figure 10-1 on page 21](#) presents the principal clock system in the XMEGA B1 family of devices. Not all of the clocks need to be active at a given time. The clocks for the CPU and peripherals can be stopped using sleep modes and power reduction registers, as described in [“Power Management and Sleep Modes” on page 23](#).

Figure 10-1. The Clock system, clock sources and clock distribution.

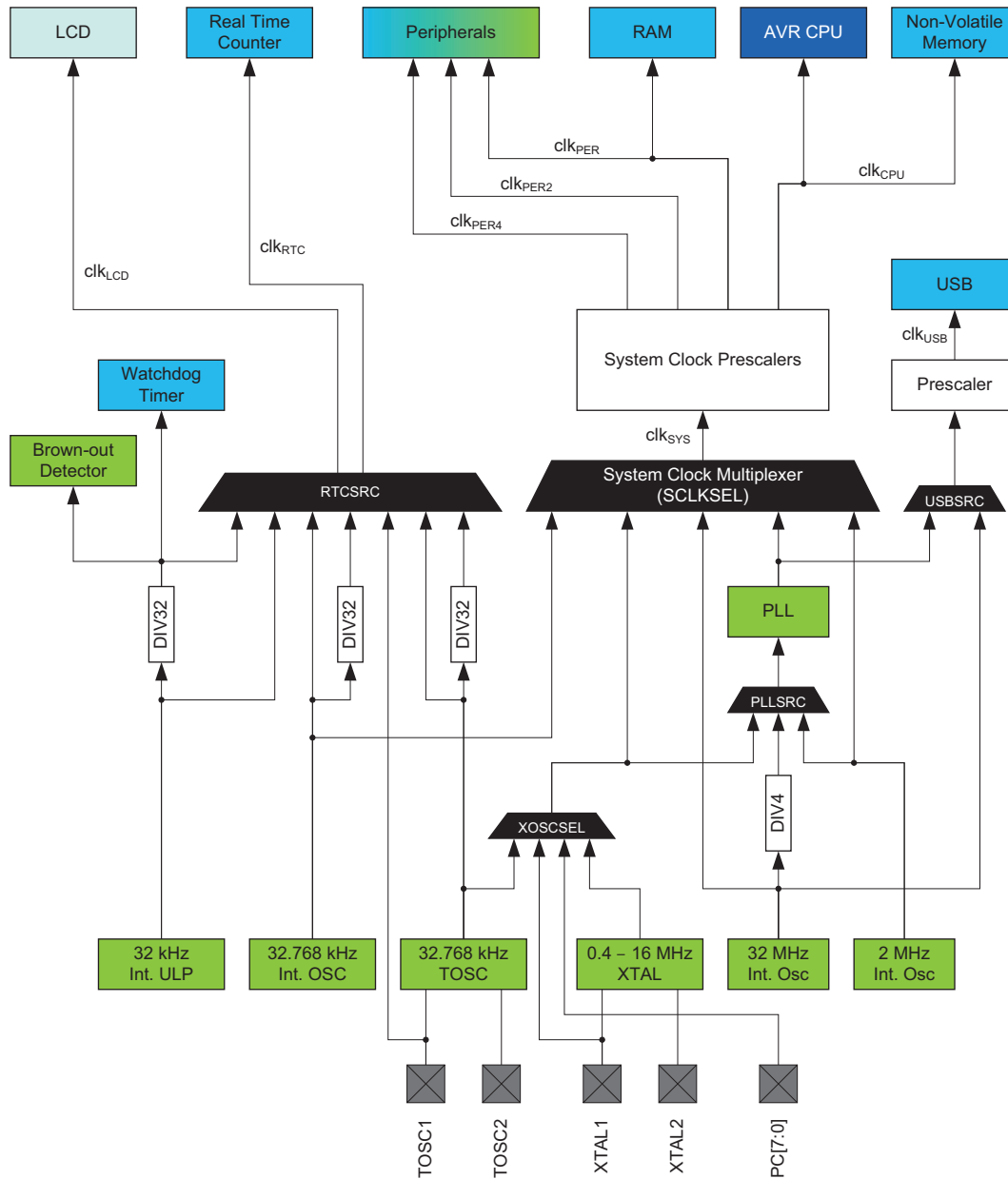

10.3 Clock Sources

The clock sources are divided in two main groups: internal oscillators and external clock sources. Most of the clock sources can be directly enabled and disabled from software, while others are automatically enabled or disabled, depending on peripheral settings. After reset, the device starts up running from the 2MHz internal oscillator. The other clock sources, DFLLs and PLL, are turned off by default.

The internal oscillators do not require any external components to run. For details on characteristics and accuracy of the internal oscillators, refer to the device datasheet.

10.3.1 32kHz Ultra Low Power Internal Oscillator

This oscillator provides an approximate 32kHz clock. The 32kHz ultra low power (ULP) internal oscillator is a very low power clock source, and it is not designed for high accuracy. The oscillator employs a built-in prescaler that provides a

1kHz output. The oscillator is automatically enabled/disabled when it is used as clock source for any part of the device. This oscillator can be selected as the clock source for the RTC and for LCD.

10.3.2 32.768kHz Calibrated Internal Oscillator

This oscillator provides an approximate 32.768kHz clock. It is calibrated during production to provide a default frequency close to its nominal frequency. The calibration register can also be written from software for run-time calibration of the oscillator frequency. The oscillator employs a built-in prescaler, which provides both a 32.768kHz output and a 1.024kHz output. This oscillator can be used as a clock source for the system clock, RTC and LCD, and as the DFLL reference clock.

10.3.3 32.768kHz Crystal Oscillator

A 32.768kHz crystal oscillator can be connected between the TOSC1 and TOSC2 pins and enables a dedicated low frequency oscillator input circuit. A low power mode with reduced voltage swing on TOSC2 is available. This oscillator can be used as a clock source for the system clock, RTC and LCD, and as the DFLL reference clock.

10.3.4 0.4 - 16MHz Crystal Oscillator

This oscillator can operate in four different modes optimized for different frequency ranges, all within 0.4MHz - 16MHz.

10.3.5 2MHz Run-time Calibrated Internal Oscillator

The 2MHz run-time calibrated internal oscillator is the default system clock source after reset. It is calibrated during production to provide a default frequency close to its nominal frequency. A DFLL can be enabled for automatic run-time calibration of the oscillator to compensate for temperature and voltage drift and optimize the oscillator accuracy.

10.3.6 32MHz Run-time Calibrated Internal Oscillator

The 32MHz run-time calibrated internal oscillator is a high-frequency oscillator. It is calibrated during production to provide a default frequency close to its nominal frequency. A digital frequency locked loop (DFLL) can be enabled for automatic run-time calibration of the oscillator to compensate for temperature and voltage drift and optimize the oscillator accuracy. This oscillator can also be adjusted and calibrated to any frequency between 30MHz and 55MHz. The production signature row contains 48 MHz calibration values intended used when the oscillator is used a full-speed USB clock source.

10.3.7 External Clock Sources

The XTAL1 and XTAL2 pins can be used to drive an external oscillator, either a quartz crystal or a ceramic resonator. XTAL1 or each pin of port C can be used as input for an external clock signal. The TOSC1 and TOSC2 pins is dedicated to driving a 32.768kHz crystal oscillator.

10.3.8 PLL with 1x-31x Multiplication Factor

The built-in phase locked loop (PLL) can be used to generate a high-frequency system clock. The PLL has a user-selectable multiplication factor of from 1 to 31. In combination with the prescalers, this gives a wide range of output frequencies from all clock sources.

11. Power Management and Sleep Modes

11.1 Features

- Power management for adjusting power consumption and functions
- Five sleep modes
 - Idle
 - Power down
 - Power save
 - Standby
 - Extended standby
- Power reduction register to disable clock and turn off unused peripherals in active and idle modes

11.2 Overview

Various sleep modes and clock gating are provided in order to tailor power consumption to application requirements. This enables the XMEGA microcontroller to stop unused modules to save power.

All sleep modes are available and can be entered from active mode. In active mode, the CPU is executing application code. When the device enters sleep mode, program execution is stopped and interrupts or a reset is used to wake the device again. The application code decides which sleep mode to enter and when. Interrupts from enabled peripherals and all enabled reset sources can restore the microcontroller from sleep to active mode.

In addition, power reduction registers provide a method to stop the clock to individual peripherals from software. When this is done, the current state of the peripheral is frozen, and there is no power consumption from that peripheral. This reduces the power consumption in active mode and idle sleep modes and enables much more fine-tuned power management than sleep modes alone.

11.3 Sleep Modes

Sleep modes are used to shut down modules and clock domains in the microcontroller in order to save power. XMEGA microcontrollers have five different sleep modes tuned to match the typical functional stages during application execution. A dedicated sleep instruction (SLEEP) is available to enter sleep mode. Interrupts are used to wake the device from sleep, and the available interrupt wake-up sources are dependent on the configured sleep mode. When an enabled interrupt occurs, the device will wake up and execute the interrupt service routine before continuing normal program execution from the first instruction after the SLEEP instruction. If other, higher priority interrupts are pending when the wake-up occurs, their interrupt service routines will be executed according to their priority before the interrupt service routine for the wake-up interrupt is executed. After wake-up, the CPU is halted for four cycles before execution starts.

The content of the register file, SRAM and registers are kept during sleep. If a reset occurs during sleep, the device will reset, start up, and execute from the reset vector.

11.3.1 Idle Mode

In idle mode the CPU and nonvolatile memory are stopped (note that any ongoing programming will be completed), but all peripherals, including the interrupt controller, event system and DMA controller are kept running. Any enabled interrupt will wake the device.

11.3.2 Power-down Mode

In power-down mode, all clocks, including the real-time counter clock source, are stopped. This allows operation only of asynchronous modules that do not require a running clock. The only interrupts that can wake up the MCU are the two-wire interface address match interrupt, asynchronous port interrupts, and the USB resume interrupt.

11.3.3 Power-save Mode

Power-save mode is identical to power down, with two exceptions:

1. If the real-time counter (RTC) is enabled, it will keep running during sleep, and the device can also wake up from either an RTC overflow or compare match interrupt.
2. If the liquid crystal display controller (LCD) is enabled, it will keep running during sleep, and the device can wake up from LCD frame completed interrupt.

11.3.4 Standby Mode

Standby mode is identical to power down, with the exception that the enabled system clock sources are kept running while the CPU, peripheral, RTC and LCD clocks are stopped. This reduces the wake-up time.

11.3.5 Extended Standby Mode

Extended standby mode is identical to power-save mode, with the exception that the enabled system clock sources are kept running while the CPU and peripheral clocks are stopped. This reduces the wake-up time.

12. System Control and Reset

12.1 Features

- Reset the microcontroller and set it to initial state when a reset source goes active
- Multiple reset sources that cover different situations
 - Power-on reset
 - External reset
 - Watchdog reset
 - Brownout reset
 - PDI reset
 - Software reset
- Asynchronous operation
 - No running system clock in the device is required for reset
- Reset status register for reading the reset source from the application code

12.2 Overview

The reset system issues a microcontroller reset and sets the device to its initial state. This is for situations where operation should not start or continue, such as when the microcontroller operates below its power supply rating. If a reset source goes active, the device enters and is kept in reset until all reset sources have released their reset. The I/O pins are immediately tri-stated. The program counter is set to the reset vector location, and all I/O registers are set to their initial values. The SRAM content is kept. However, if the device accesses the SRAM when a reset occurs, the content of the accessed location can not be guaranteed.

After reset is released from all reset sources, the default oscillator is started and calibrated before the device starts running from the reset vector address. By default, this is the lowest program memory address, 0, but it is possible to move the reset vector to the lowest address in the boot section.

The reset functionality is asynchronous, and so no running system clock is required to reset the device. The software reset feature makes it possible to issue a controlled system reset from the user software.

The reset status register has individual status flags for each reset source. It is cleared at power-on reset, and shows which sources have issued a reset since the last power-on.

12.3 Reset Sequence

A reset request from any reset source will immediately reset the device and keep it in reset as long as the request is active. When all reset requests are released, the device will go through three stages before the device starts running again:

- Reset counter delay
- Oscillator startup
- Oscillator calibration

If another reset requests occurs during this process, the reset sequence will start over again.

12.4 Reset Sources

12.4.1 Power-on Reset

A power-on reset (POR) is generated by an on-chip detection circuit. The POR is activated when the V_{CC} rises and reaches the POR threshold voltage (V_{POT}), and this will start the reset sequence.

The POR is also activated to power down the device properly when the V_{CC} falls and drops below the V_{POT} level.

The V_{POT} level is higher for falling V_{CC} than for rising V_{CC} . Consult the datasheet for POR characteristics data.

12.4.2 Brownout Detection

The on-chip brownout detection (BOD) circuit monitors the V_{CC} level during operation by comparing it to a fixed, programmable level that is selected by the BODLEVEL fuses. If disabled, BOD is forced on at the lowest level during chip erase and when the PDI is enabled.

12.4.3 External Reset

The external reset circuit is connected to the external $\overline{\text{RESET}}$ pin. The external reset will trigger when the $\overline{\text{RESET}}$ pin is driven below the $\overline{\text{RESET}}$ pin threshold voltage, V_{RST} , for longer than the minimum pulse period, t_{EXT} . The reset will be held as long as the pin is kept low. The $\overline{\text{RESET}}$ pin includes an internal pull-up resistor.

12.4.4 Watchdog Reset

The watchdog timer (WDT) is a system function for monitoring correct program operation. If the WDT is not reset from the software within a programmable timeout period, a watchdog reset will be given. The watchdog reset is active for one to two clock cycles of the 2MHz internal oscillator. For more details see [“WDT – Watchdog Timer” on page 27](#).

12.4.5 Software Reset

The software reset makes it possible to issue a system reset from software by writing to the software reset bit in the reset control register. The reset will be issued within two CPU clock cycles after writing the bit. It is not possible to execute any instruction from when a software reset is requested until it is issued.

12.4.6 Program and Debug Interface Reset

The program and debug interface reset contains a separate reset source that is used to reset the device during external programming and debugging. This reset source is accessible only from external debuggers and programmers.

13. WDT – Watchdog Timer

13.1 Features

- Issues a device reset if the timer is not reset before its timeout period
- Asynchronous operation from dedicated oscillator
- 1kHz output of the 32kHz ultra low power oscillator
- 11 selectable timeout periods, from 8ms to 8s
- Two operation modes:
 - Normal mode
 - Window mode
- Configuration lock to prevent unwanted changes

13.2 Overview

The watchdog timer (WDT) is a system function for monitoring correct program operation. It makes it possible to recover from error situations such as runaway or deadlocked code. The WDT is a timer, configured to a predefined timeout period, and is constantly running when enabled. If the WDT is not reset within the timeout period, it will issue a microcontroller reset. The WDT is reset by executing the WDR (watchdog timer reset) instruction from the application code.

The window mode makes it possible to define a time slot or window inside the total timeout period during which WDT must be reset. If the WDT is reset outside this window, either too early or too late, a system reset will be issued. Compared to the normal mode, this can also catch situations where a code error causes constant WDR execution.

The WDT will run in active mode and all sleep modes, if enabled. It is asynchronous, runs from a CPU-independent clock source, and will continue to operate to issue a system reset even if the main clocks fail.

The configuration change protection mechanism ensures that the WDT settings cannot be changed by accident. For increased safety, a fuse for locking the WDT settings is also available.

14. Interrupts and Programmable Multilevel Interrupt Controller

14.1 Features

- Short and predictable interrupt response time
- Separate interrupt configuration and vector address for each interrupt
- Programmable multilevel interrupt controller
 - Interrupt prioritizing according to level and vector address
 - Three selectable interrupt levels for all interrupts: low, medium and high
 - Selectable, round-robin priority scheme within low-level interrupts
 - Non-maskable interrupts for critical functions
- Interrupt vectors optionally placed in the application section or the boot loader section

14.2 Overview

Interrupts signal a change of state in peripherals, and this can be used to alter program execution. Peripherals can have one or more interrupts, and all are individually enabled and configured. When an interrupt is enabled and configured, it will generate an interrupt request when the interrupt condition is present. The programmable multilevel interrupt controller (PMIC) controls the handling and prioritizing of interrupt requests. When an interrupt request is acknowledged by the PMIC, the program counter is set to point to the interrupt vector, and the interrupt handler can be executed.

All peripherals can select between three different priority levels for their interrupts: low, medium, and high. Interrupts are prioritized according to their level and their interrupt vector address. Medium-level interrupts will interrupt low-level interrupt handlers. High-level interrupts will interrupt both medium- and low-level interrupt handlers. Within each level, the interrupt priority is decided from the interrupt vector address, where the lowest interrupt vector address has the highest interrupt priority. Low-level interrupts have an optional round-robin scheduling scheme to ensure that all interrupts are serviced within a certain amount of time.

Non-maskable interrupts (NMI) are also supported, and can be used for system critical functions.

14.3 Interrupt vectors

The interrupt vector is the sum of the peripheral's base interrupt address and the offset address for specific interrupts in each peripheral. The base addresses for the XMEGA B1 devices are shown in [Table 14-1](#). Offset addresses for each interrupt available in the peripheral are described for each peripheral in the XMEGA B manual. For peripherals or modules that have only one interrupt, the interrupt vector is shown in [Table 14-1](#). The program address is the word address.

Table 14-1. Reset and Interrupt Vectors.

Program Address (Base Address)	Source	Interrupt Description
0x000	RESET	
0x002	OSCF_INT_vect	Crystal Oscillator Failure Interrupt vector (NMI)
0x004	PORTC_INT_base	Port C Interrupt base
0x008	PORTR_INT_base	Port R Interrupt base
0x00C	DMA_INT_base	DMA Controller Interrupt base
0x014	RTC_INT_base	Real Time Counter Interrupt base
0x018	TWIC_INT_base	Two-Wire Interface on Port C Interrupt base
0x01C	TCC0_INT_base	Timer/Counter 0 on port C Interrupt base

Program Address (Base Address)	Source	Interrupt Description
0x028	TCC1_INT_base	Timer/Counter 1 on port C Interrupt base
0x030	SPIC_INT_vect	SPI on port C Interrupt vector
0x032	USARTC0_INT_base	USART 0 on port C Interrupt base
0x03E	USB_INT_base	USB on port D Interrupt base
0x046	LCD_INT_base	LCD Interrupt base
0x048	AES_INT_vect	AES Interrupt vector
0x04A	NVM_INT_base	Non-Volatile Memory Interrupt base
0x04E	PORTB_INT_base	Port B Interrupt base
0x052	ACB_INT_base	Analog Comparator on Port B Interrupt base
0x058	ADCB_INT_base	Analog to Digital Converter on Port B Interrupt base
0x060	PORTD_INT_base	Port D Interrupt base
0x064	PORTG_INT_base	Port G Interrupt base
0x068	PORTM_INT_base	Port M Interrupt base
0x06C	PORTE_INT_base	Port E Interrupt base
0x074	TCE0_INT_base	Timer/Counter 0 on port E Interrupt base
0x08A	USARTE0_INT_base	USART 0 on port E Interrupt base
0x096	PORTA_INT_base	Port A Interrupt base
0x09A	ACA_INT_base	Analog Comparator on Port A Interrupt base
0x0A0	ADCA_INT_base	Analog to Digital Converter on Port A Interrupt base

15. I/O Ports

15.1 Features

- 53 General purpose input and output pins with individual configuration
- Output driver with configurable driver and pull settings:
 - Totem-pole
 - Wired-AND
 - Wired-OR
 - Bus-keeper
 - Inverted I/O
- Input with synchronous and/or asynchronous sensing with interrupts and events
 - Sense both edges
 - Sense rising edges
 - Sense falling edges
 - Sense low level
- Optional pull-up and pull-down resistor on input and Wired-OR/AND configurations
- Optional slew rate control
- Asynchronous pin change sensing that can wake the device from all sleep modes
- Two port interrupts with pin masking per I/O port
- Efficient and safe access to port pins
 - Hardware read-modify-write through dedicated toggle/clear/set registers
 - Configuration of multiple pins in a single operation
 - Mapping of port registers into bit-accessible I/O memory space
- Peripheral clocks output on port pin
- Real-time counter clock output to port pin
- Event channels can be output on port pin
- Remapping of digital peripheral pin functions
 - Selectable USART, SPI, and timer/counter input/output pin locations

15.2 Overview

One port consists of up to eight port pins: pin 0 to 7. Each port pin can be configured as input or output with configurable driver and pull settings. They also implement synchronous and asynchronous input sensing with interrupts and events for selectable pin change conditions. Asynchronous pin-change sensing means that a pin change can wake the device from all sleep modes, included the modes where no clocks are running.

All functions are individual and configurable per pin, but several pins can be configured in a single operation. The pins have hardware read-modify-write (RMW) functionality for safe and correct change of drive value and/or pull resistor configuration. The direction of one port pin can be changed without unintentionally changing the direction of any other pin.

The port pin configuration also controls input and output selection of other device functions. It is possible to have both the peripheral clock and the real-time clock output to a port pin, and available for external use. The same applies to events from the event system that can be used to synchronize and control external functions. Other digital peripherals, such as USART, SPI, and timer/counters, can be remapped to selectable pin locations in order to optimize pin-out versus application needs.

The notation of the ports are PORTA, PORTB, PORTC, PORTD, PORTE, PORTG, PORTM and PORTR.

15.3 Output Driver

All port pins (P_n) have programmable output configuration. The port pins also have configurable slew rate limitation to reduce electromagnetic emission.

15.3.1 Push-pull

Figure 15-1. I/O configuration - Totem-pole

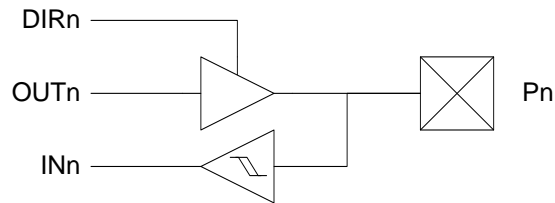

15.3.2 Pull-down

Figure 15-2. I/O configuration - Totem-pole with pull-down (on input)

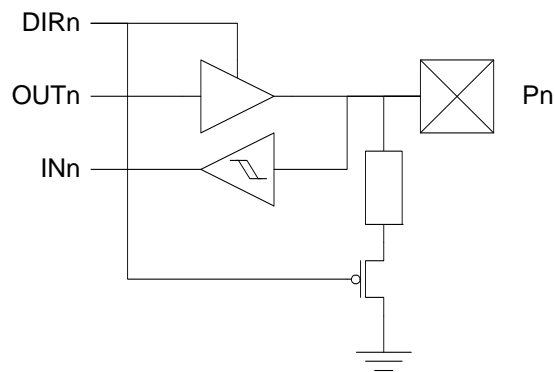

15.3.3 Pull-up

Figure 15-3. I/O configuration - Totem-pole with pull-up (on input)

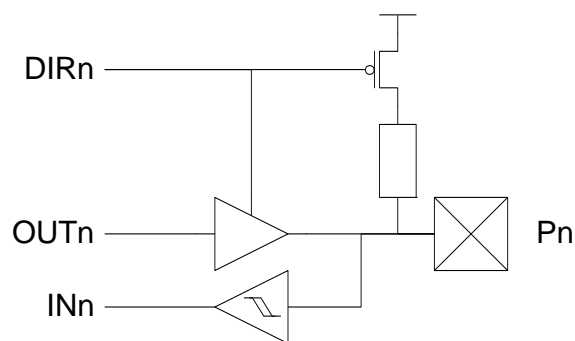

15.3.4 Bus-keeper

The bus-keeper's weak output produces the same logical level as the last output level. It acts as a pull-up if the last level was '1', and pull-down if the last level was '0'.

Figure 15-4. I/O configuration - Totem-pole with bus-keeper

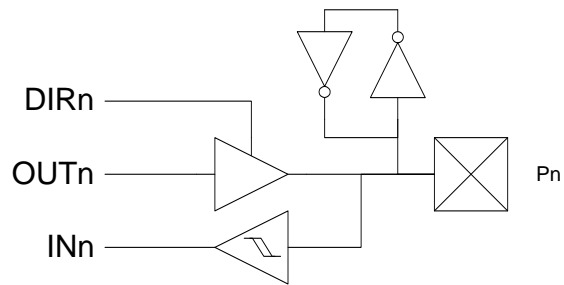

15.3.5 Others

Figure 15-5. Output configuration - Wired-OR with optional pull-down

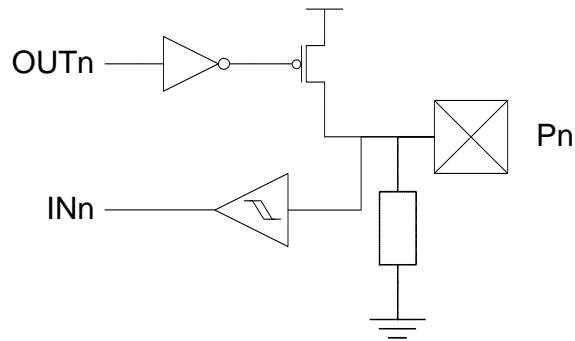
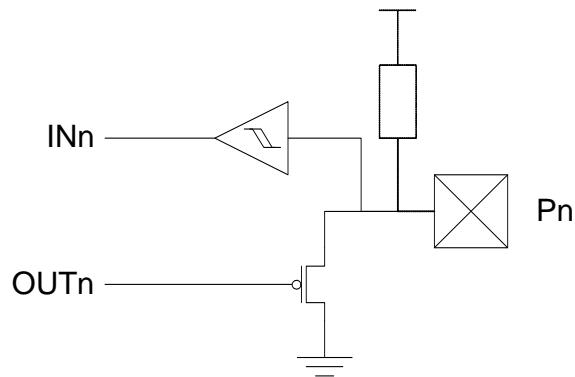

Figure 15-6. I/O configuration - Wired-AND with optional pull-up



15.4 Input sensing

Input sensing is synchronous or asynchronous depending on the enabled clock for the ports, and the configuration is shown in [Figure 15-7 on page 33](#).

Figure 15-7. Input sensing system overview

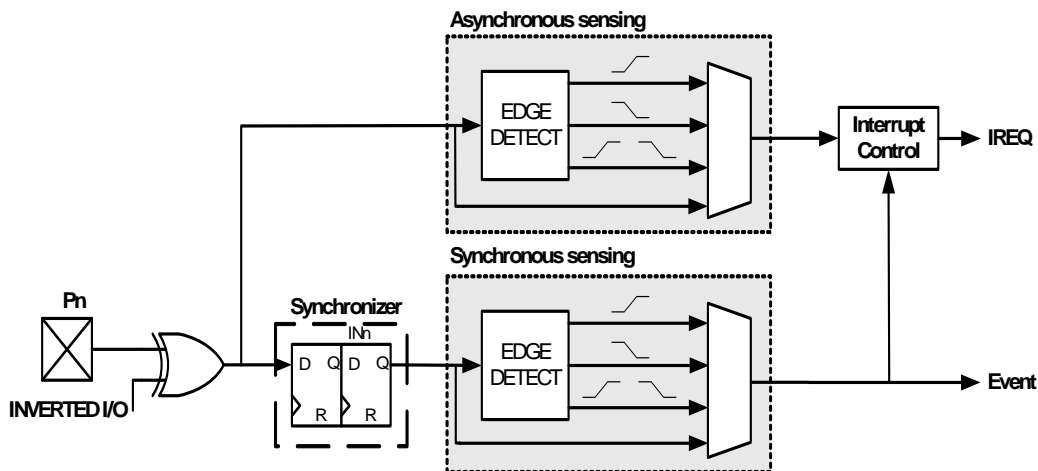

When a pin is configured with inverted I/O, the pin value is inverted before the input sensing.

15.5 Alternate Port Functions

Most port pins have alternate pin functions in addition to being a general purpose I/O pin. When an alternate function is enabled, it might override the normal port pin function or pin value. This happens when other peripherals that require pins are enabled or configured to use pins. If and how a peripheral will override and use pins is described in the section for that peripheral. ["Pinout and Pin Functions" on page 54](#) shows which modules on peripherals that enable alternate functions on a pin, and which alternate functions that are available on a pin.

16. T/C – 16-bit Timer/Counter Type 0 and 1

16.1 Features

- Three 16-bit timer/counters
 - Two timer/counters of type 0
 - One timer/counters of type 1
- 32-bit Timer/Counter support by cascading two timer/counters
- Up to four compare or capture (CC) channels
 - Four CC channels for timer/counters of type 0
 - Two CC channels for timer/counters of type 1
- Double buffered timer period setting
- Double buffered capture or compare channels
- Waveform generation:
 - Frequency generation
 - Single-slope pulse width modulation
 - Dual-slope pulse width modulation
- Input capture:
 - Input capture with noise cancelling
 - Frequency capture
 - Pulse width capture
 - 32-bit input capture
- Timer overflow and error interrupts/events
- One compare match or input capture interrupt/event per CC channel
- Can be used with event system for:
 - Quadrature decoding
 - Count and direction control
 - Capture
- Can be used with DMA and to trigger DMA transactions
- High-resolution extension
 - Increases frequency and waveform resolution by 4x (2-bit) or 8x (3-bit)
- Advanced waveform extension:
 - Low- and high-side output with programmable dead-time insertion (DTI)
- Event controlled fault protection for safe disabling of drivers

16.2 Overview

Atmel AVR XMEGA devices have a set of three flexible 16-bit Timer/Counters (TC). Their capabilities include accurate program execution timing, frequency and waveform generation, and input capture with time and frequency measurement of digital signals. Two timer/counters can be cascaded to create a 32-bit timer/counter with optional 32-bit capture.

A timer/counter consists of a base counter and a set of compare or capture (CC) channels. The base counter can be used to count clock cycles or events. It has direction control and period setting that can be used for timing. The CC channels can be used together with the base counter to do compare match control, frequency generation, and pulse width waveform modulation, as well as various input capture operations. A timer/counter can be configured for either capture or compare functions, but cannot perform both at the same time.

A timer/counter can be clocked and timed from the peripheral clock with optional prescaling or from the event system. The event system can also be used for direction control and capture trigger or to synchronize operations.

There are two differences between timer/counter type 0 and type 1. Timer/counter 0 has four CC channels, and timer/counter 1 has two CC channels. All information related to CC channels 3 and 4 is valid only for timer/counter 0. Only Timer/Counter 0 has the split mode feature that split it into 2 8-bit Timer/Counters with four compare channels each.

Some timer/counters have extensions to enable more specialized waveform and frequency generation. The advanced waveform extension (AWeX) is intended for motor control and other power control applications. It enables low- and high-side output with dead-time insertion, as well as fault protection for disabling and shutting down external drivers. It can also generate a synchronized bit pattern across the port pins.

The Advanced Waveform Extension can be enabled to provide extra and more advanced features for the Timer/Counter. This are only available for Timer/Counter 0. See “TC2 –16-bit Timer/Counter Type 2” on page 36 for more details.

The high-resolution (hi-res) extension can be used to increase the waveform output resolution by four or eight times by using an internal clock source running up to four times faster than the peripheral clock. See “Hi-Res – High Resolution Extension” on page 38 for more details.

Figure 16-1. Overview of a Timer/Counter and closely related peripherals

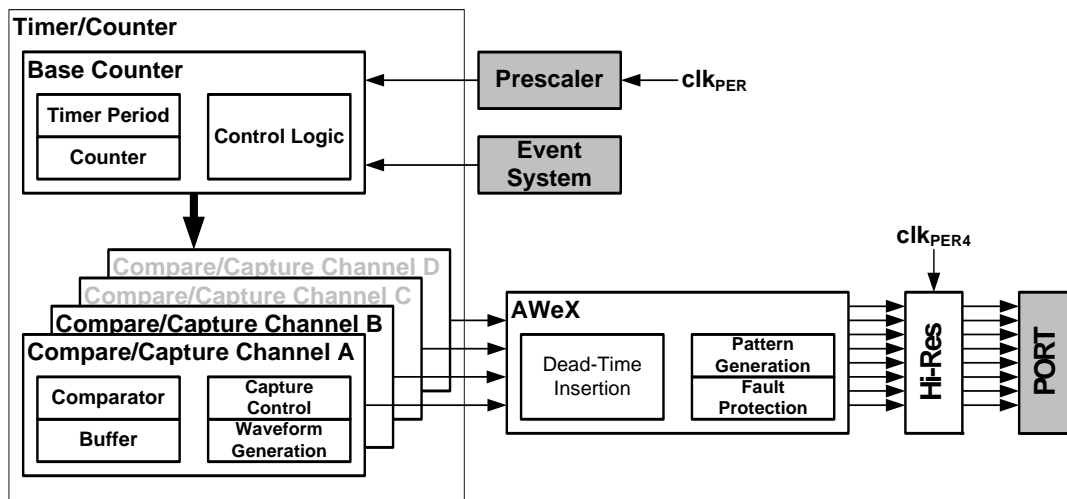

PORTC has one Timer/Counter 0 and one Timer/Counter1. PORTE has one Timer/Counter 0. Notation of these are TCC0 (Time/Counter C0), TCC1, and TCE0, respectively.

17. TC2 –16-bit Timer/Counter Type 2

17.1 Features

- A system of two eight-bit timer/counters
 - Low-byte timer/counter
 - High-byte timer/counter
- Eight compare channels
 - Four compare channels for the low-byte timer/counter
 - Four compare channels for the high-byte timer/counter
- Waveform generation
 - Single slope pulse width modulation
- Timer underflow interrupts/events
- One compare match interrupt/event per compare channel for the low-byte timer/counter
- Can be used with the event system for count control
- Can be used to trigger DMA transactions
- High-resolution extension increases frequency and waveform resolution by 4x or 8x

17.2 Overview

A timer/counter 2 is realized when a timer/counter 0 is set in split mode. It is a system of two eight-bit timer/counters, each with four compare channels. This results in eight configurable pulse width modulation (PWM) channels with individually controlled duty cycles, and is intended for applications that require a high number of PWM channels.

The two eight-bit timer/counters in this system are referred to as the low-byte timer/counter and high-byte timer/counter, respectively. The difference between them is that only the low-byte timer/counter can be used to generate compare match interrupts, events and DMA triggers.

The two eight-bit timer/counters have a shared clock source and separate period and compare settings. They can be clocked and timed from the peripheral clock, with optional prescaling, or from the event system. The counters are always counting down.

The timer/counter 2 is set back to timer/counter 0 by setting it in normal mode; hence, one timer/counter can exist only as either type 0 or type 2.

PORTC and PORTE each has one Timer/Counter 2. Notation of these are TCC2 (Time/Counter C2) and TCE2 respectively.

18. AWeX – Advanced Waveform Extension

18.1 Features

- Waveform output with complementary output from each compare channel
- Four dead-time insertion (DTI) units
 - 8-bit resolution
 - Separate high and low side dead-time setting
 - Double buffered dead time
 - Optionally halts timer during dead-time insertion
- Pattern generation unit creating synchronised bit pattern across the port pins
 - Double buffered pattern generation
 - Optional distribution of one compare channel output across the port pins
- Event controlled fault protection for instant and predictable fault triggering

18.2 Overview

The advanced waveform extension (AWeX) provides extra functions to the timer/counter in waveform generation (WG) modes. It is primarily intended for use with different types of motor control and other power control applications. It enables low- and high side output with dead-time insertion and fault protection for disabling and shutting down external drivers. It can also generate a synchronized bit pattern across the port pins.

Each of the waveform generator outputs from the timer/counter 0 are split into a complimentary pair of outputs when any AWeX features are enabled. These output pairs go through a dead-time insertion (DTI) unit that generates the non-inverted low side (LS) and inverted high side (HS) of the WG output with dead-time insertion between LS and HS switching. The DTI output will override the normal port value according to the port override setting.

The pattern generation unit can be used to generate a synchronized bit pattern on the port it is connected to. In addition, the WG output from compare channel A can be distributed to and override all the port pins. When the pattern generator unit is enabled, the DTI unit is bypassed.

The fault protection unit is connected to the event system, enabling any event to trigger a fault condition that will disable the AWeX output. The event system ensures predictable and instant fault reaction, and gives flexibility in the selection of fault triggers.

The AWEX is available for TCC0. The notation of this is AWEXC.

19. Hi-Res – High Resolution Extension

19.1 Features

- Increases waveform generator resolution up to 8x (3 bits)
- Supports frequency, single-slope PWM, and dual-slope PWM generation
- Supports the AWeX when this is used for the same timer/counter

19.2 Overview

The high-resolution (hi-res) extension can be used to increase the resolution of the waveform generation output from a timer/counter by four or eight. It can be used for a timer/counter doing frequency, single-slope PWM, or dual-slope PWM generation. It can also be used with the AWeX if this is used for the same timer/counter.

The hi-res extension uses the peripheral 4x clock (Clk_{PER4}). The system clock prescalers must be configured so the peripheral 4x clock frequency is four times higher than the peripheral and CPU clock frequency when the hi-res extension is enabled.

Atmel AVR XMEGA B1 devices have one Hi-Res Extension that can be enabled for the timer/counters pair on PORTC. The notation of this is HIRESC.

20. RTC – 16-bit Real-Time Counter

20.1 Features

- 16-bit resolution
- Selectable clock source
 - 32.768kHz external crystal
 - External clock
 - 32.768kHz internal oscillator
 - 32kHz internal ULP oscillator
- Programmable 10-bit clock prescaling
- One compare register
- One period register
- Clear counter on period overflow
- Optional interrupt/event on overflow and compare match

20.2 Overview

The 16-bit real-time counter (RTC) is a counter that typically runs continuously, including in low-power sleep modes, to keep track of time. It can wake up the device from sleep modes and/or interrupt the device at regular intervals.

The reference clock is typically the 1.024kHz output from a high-accuracy crystal of 32.768kHz, and this is the configuration most optimized for low power consumption. The faster 32.768kHz output can be selected if the RTC needs a resolution higher than 1ms. The RTC can also be clocked from an external clock signal, the 32.768kHz internal oscillator or the 32kHz internal ULP oscillator.

The RTC includes a 10-bit programmable prescaler that can scale down the reference clock before it reaches the counter. A wide range of resolutions and time-out periods can be configured. With a 32.768kHz clock source, the maximum resolution is 30.5 μ s, and time-out periods can range up to 2000 seconds. With a resolution of 1s, the maximum timeout period is more than 18 hours (65536 seconds). The RTC can give a compare interrupt and/or event when the counter equals the compare register value, and an overflow interrupt and/or event when it equals the period register value.

Figure 20-1. Real-time Counter overview

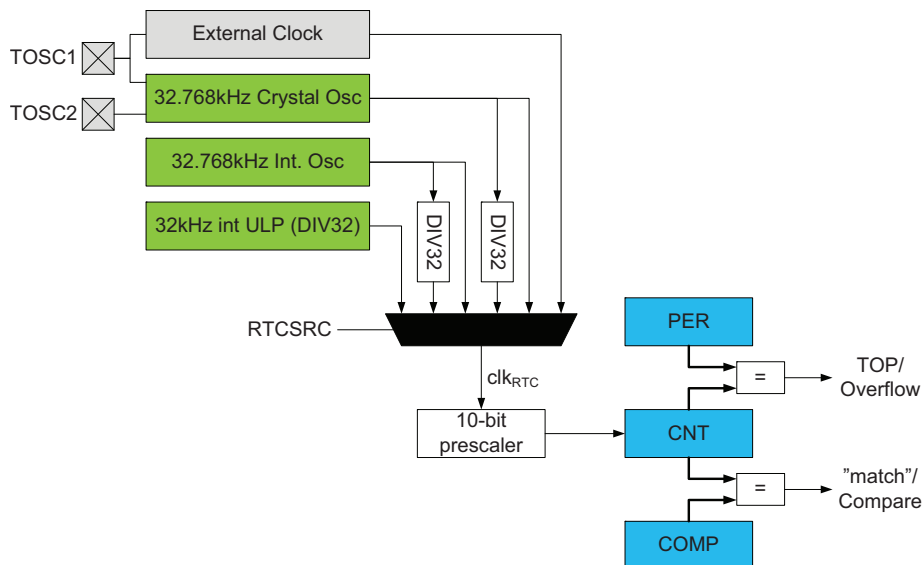

21. USB – Universal Serial Bus Interface

21.1 Features

- One USB 2.0 full speed (12Mbps) and low speed (1.5Mbps) device compliant interface
- Integrated on-chip USB transceiver, no external components needed
- 16 endpoint addresses with full endpoint flexibility for up to 31 endpoints
 - One input endpoint per endpoint address
 - One output endpoint per endpoint address
- Endpoint address transfer type selectable to
 - Control transfers
 - Interrupt transfers
 - Bulk transfers
 - Isochronous transfers
- Configurable data payload size per endpoint, up to 1023 bytes
- Endpoint configuration and data buffers located in internal SRAM
 - Configurable location for endpoint configuration data
 - Configurable location for each endpoint's data buffer
- Built-in direct memory access (DMA) to internal SRAM for:
 - Endpoint configurations
 - Reading and writing endpoint data
- Ping-pong operation for higher throughput and double buffered operation
 - Input and output endpoint data buffers used in a single direction
 - CPU/DMA controller can update data buffer during transfer
- Multipacket transfer for reduced interrupt load and software intervention
 - Data payload exceeding maximum packet size is transferred in one continuous transfer
 - No interrupts or software interaction on packet transaction level
- Transaction complete FIFO for workflow management when using multiple endpoints
 - Tracks all completed transactions in a first-come, first-served work queue
- Clock selection independent of system clock source and selection
- Minimum 1.5MHz CPU clock required for low speed USB operation
- Minimum 12MHz CPU clock required for full speed operation
- Connection to event system
- On chip debug possibilities during USB transactions

21.2 Overview

The USB module is a USB 2.0 full speed (12Mbps) and low speed (1.5Mbps) device compliant interface.

The USB supports 16 endpoint addresses. All endpoint addresses have one input and one output endpoint, for a total of 31 configurable endpoints and one control endpoint. Each endpoint address is fully configurable and can be configured for any of the four transfer types: control, interrupt, bulk, or isochronous. The data payload size is also selectable, and it supports data payloads up to 1023 bytes.

No dedicated memory is allocated for or included in the USB module. Internal SRAM is used to keep the configuration for each endpoint address and the data buffer for each endpoint. The memory locations used for endpoint configurations and data buffers are fully configurable. The amount of memory allocated is fully dynamic, according to the number of endpoints in use and the configuration of these. The USB module has built-in direct memory access (DMA), and will read/write data from/to the SRAM when a USB transaction takes place.

To maximize throughput, an endpoint address can be configured for ping-pong operation. When done, the input and output endpoints are both used in the same direction. The CPU or DMA controller can then read/write one data buffer while the USB module writes/reads the others, and vice versa. This gives double buffered communication.

Multipacket transfer enables a data payload exceeding the maximum packet size of an endpoint to be transferred as multiple packets without software intervention. This reduces the CPU intervention and the interrupts needed for USB transfers.

For low-power operation, the USB module can put the microcontroller into any sleep mode when the USB bus is idle and a suspend condition is given. Upon bus resumes, the USB module can wake up the microcontroller from any sleep mode.

PORTD has one USB. Notation of this is USB.

22. TWI – Two Wire Interface

22.1 Features

- One two-wire interface peripheral
- Bidirectional, two-wire communication interface
 - Phillips I²C compatible
 - System Management Bus (SMBus) compatible
- Bus master and slave operation supported
 - Slave operation
 - Single bus master operation
 - Bus master in multi-master bus environment
 - Multi-master arbitration
- Flexible slave address match functions
 - 7-bit and general call address recognition in hardware
 - 10-bit addressing supported
 - Address mask register for dual address match or address range masking
 - Optional software address recognition for unlimited number of addresses
- Slave can operate in all sleep modes, including power-down
- Slave address match can wake device from all sleep modes
- 100kHz and 400kHz bus frequency support
- Slew-rate limited output drivers
- Input filter for bus noise and spike suppression
- Support arbitration between start/repeated start and data bit (SMBus)
- Slave arbitration allows support for address resolve protocol (ARP) (SMBus)

22.2 Overview

The two-wire interface (TWI) is a bidirectional, two-wire communication interface. It is I²C and System Management Bus (SMBus) compatible. The only external hardware needed to implement the bus is one pull-up resistor on each bus line.

A device connected to the bus must act as a master or a slave. The master initiates a data transaction by addressing a slave on the bus and telling whether it wants to transmit or receive data. One bus can have many slaves and one or several masters that can take control of the bus. An arbitration process handles priority if more than one master tries to transmit data at the same time. Mechanisms for resolving bus contention are inherent in the protocol.

The TWI module supports master and slave functionality. The master and slave functionality are separated from each other, and can be enabled and configured separately. The master module supports multi-master bus operation and arbitration. It contains the baud rate generator. Both 100kHz and 400kHz bus frequency is supported. Quick command and smart mode can be enabled to auto-trigger operations and reduce software complexity.

The slave module implements 7-bit address match and general address call recognition in hardware. 10-bit addressing is also supported. A dedicated address mask register can act as a second address match register or as a register for address range masking. The slave continues to operate in all sleep modes, including power-down mode. This enables the slave to wake up the device from all sleep modes on TWI address match. It is possible to disable the address matching to let this be handled in software instead.

The TWI module will detect START and STOP conditions, bus collisions, and bus errors. Arbitration lost, errors, collision, and clock hold on the bus are also detected and indicated in separate status flags available in both master and slave modes.

It is possible to disable the TWI drivers in the device, and enable a four-wire digital interface for connecting to an external TWI bus driver. This can be used for applications where the device operates from a different V_{CC} voltage than used by the TWI bus.

PORTC has one TWI. Notation of this peripheral is TWIC.

23. SPI – Serial Peripheral Interface

23.1 Features

- One SPI peripheral
- Full-duplex, three-wire synchronous data transfer
- Master or slave operation
- Lsb first or msb first data transfer
- Eight programmable bit rates
- Interrupt flag at the end of transmission
- Write collision flag to indicate data collision
- Wake up from idle sleep mode
- Double speed master mode

23.2 Overview

The Serial Peripheral Interface (SPI) is a high-speed synchronous data transfer interface using three or four pins. It allows fast communication between an XMEGA device and peripheral devices or between several microcontrollers. The SPI supports full-duplex communication.

A device connected to the bus must act as a master or slave. The master initiates and controls all data transactions.

PORTC has one SPI. Notation of this peripheral is SPIC.

24. USART

24.1 Features

- Two Identical USART peripherals
- Full-duplex operation
- Asynchronous or synchronous operation
 - Synchronous clock rates up to 1/2 of the device clock frequency
 - Asynchronous clock rates up to 1/8 of the device clock frequency
- Supports serial frames with 5, 6, 7, 8, or 9 data bits and 1 or 2 stop bits
- Fractional baud rate generator
 - Can generate desired baud rate from any system clock frequency
 - No need for external oscillator with certain frequencies
- Built-in error detection and correction schemes
 - Odd or even parity generation and parity check
 - Data overrun and framing error detection
 - Noise filtering includes false start bit detection and digital low-pass filter
- Separate interrupts for
 - Transmit complete
 - Transmit data register empty
 - Receive complete
- Multiprocessor communication mode
 - Addressing scheme to address a specific devices on a multidevice bus
 - Enable unaddressed devices to automatically ignore all frames
- Master SPI mode
 - Double buffered operation
 - Configurable data order
 - Operation up to 1/2 of the peripheral clock frequency
- IRCOM module for IrDA compliant pulse modulation/demodulation

24.2 Overview

The universal synchronous and asynchronous serial receiver and transmitter (USART) is a fast and flexible serial communication module. The USART supports full-duplex communication and asynchronous and synchronous operation. The USART can be configured to operate in SPI master mode and used for SPI communication.

Communication is frame based, and the frame format can be customized to support a wide range of standards. The USART is buffered in both directions, enabling continued data transmission without any delay between frames. Separate interrupts for receive and transmit complete enable fully interrupt driven communication. Frame error and buffer overflow are detected in hardware and indicated with separate status flags. Even or odd parity generation and parity check can also be enabled.

The clock generator includes a fractional baud rate generator that is able to generate a wide range of USART baud rates from any system clock frequencies. This removes the need to use an external crystal oscillator with a specific frequency to achieve a required baud rate. It also supports external clock input in synchronous slave operation.

When the USART is set in master SPI mode, all USART-specific logic is disabled, leaving the transmit and receive buffers, shift registers, and baud rate generator enabled. Pin control and interrupt generation are identical in both modes. The registers are used in both modes, but their functionality differs for some control settings.

An IRCOM module can be enabled for one USART to support IrDA 1.4 physical compliant pulse modulation and demodulation for baud rates up to 115.2kbps.

PORTC and PORTE each has one USART. Notation of these peripherals are USARTC0 and USARTE0 respectively.

25. IRCOM – IR Communication Module

25.1 Features

- Pulse modulation/demodulation for infrared communication
- IrDA compatible for baud rates up to 115.2kbps
- Selectable pulse modulation scheme
 - 3/16 of the baud rate period
 - Fixed pulse period, 8-bit programmable
 - Pulse modulation disabled
- Built-in filtering
- Can be connected to and used by any USART

25.2 Overview

XMEGA devices contain an infrared communication module (IRCOM) that is IrDA compatible for baud rates up to 115.2kbps. It can be connected to any USART to enable infrared pulse encoding/decoding for that USART.

26. AES and DES Crypto Engine

26.1 Features

- Data Encryption Standard (DES) CPU instruction
- Advanced Encryption Standard (AES) crypto module
- DES Instruction
 - Encryption and decryption
 - DES supported
 - Encryption/decryption in 16 CPU clock cycles per 8-byte block
- AES crypto module
 - Encryption and decryption
 - Supports 128-bit keys
 - Supports XOR data load mode to the state memory
 - Encryption/decryption in 375 clock cycles per 16-byte block

26.2 Overview

The Advanced Encryption Standard (AES) and Data Encryption Standard (DES) are two commonly used standards for cryptography. These are supported through an AES peripheral module and a DES CPU instruction, and the communication interfaces and the CPU can use these for fast, encrypted communication and secure data storage.

DES is supported by an instruction in the AVR CPU. The 8-byte key and 8-byte data blocks must be loaded into the register file, and then the DES instruction must be executed 16 times to encrypt/decrypt the data block.

The AES crypto module encrypts and decrypts 128-bit data blocks with the use of a 128-bit key. The key and data must be loaded into the key and state memory in the module before encryption/decryption is started. It takes 375 peripheral clock cycles before the encryption/decryption is done. The encrypted/decrypted data can then be read out, and an optional interrupt can be generated. The AES crypto module also has DMA support with transfer triggers when encryption/decryption is done and optional auto-start of encryption/decryption when the state memory is fully loaded.

27. CRC – Cyclic Redundancy Check Generator

27.1 Features

- Cyclic redundancy check (CRC) generation and checking for
 - Communication data
 - Program or data in flash memory
 - Data in SRAM and I/O memory space
- Integrated with flash memory, DMA controller and CPU
 - Continuous CRC on data going through a DMA channel
 - Automatic CRC of the complete or a selectable range of the flash memory
 - CPU can load data to the CRC generator through the I/O interface
- CRC polynomial software selectable to
 - CRC-16 (CRC-CCITT)
 - CRC-32 (IEEE 802.3)
- Zero remainder detection

27.2 Overview

A cyclic redundancy check (CRC) is an error detection technique test algorithm used to find accidental errors in data, and it is commonly used to determine the correctness of a data transmission, and data present in the data and program memories. A CRC takes a data stream or a block of data as input and generates a 16- or 32-bit output that can be appended to the data and used as a checksum. When the same data are later received or read, the device or application repeats the calculation. If the new CRC result does not match the one calculated earlier, the block contains a data error. The application will then detect this and may take a corrective action, such as requesting the data to be sent again or simply not using the incorrect data.

Typically, an n-bit CRC applied to a data block of arbitrary length will detect any single error burst not longer than n bits (any single alteration that spans no more than n bits of the data), and will detect the fraction $1-2^{-n}$ of all longer error bursts. The CRC module in XMEGA devices supports two commonly used CRC polynomials; CRC-16 (CRC-CCITT) and CRC-32 (IEEE 802.3).

- **CRC-16:**

Polynomial:	$x^{16}+x^{12}+x^5+1$
-------------	-----------------------

Hex value:	0x1021
------------	--------

- **CRC-32:**

Polynomial:	$x^{32}+x^{26}+x^{23}+x^{22}+x^{16}+x^{12}+x^{11}+x^{10}+x^8+x^7+x^5+x^4+x^2+x+1$
-------------	---

Hex value:	0x04C11DB7
------------	------------

28. LCD - Liquid Crystal Display Controller

28.1 Features

- Display capacity up to 40 segment and up to 4 common terminals
- Supports up to 16 GPIO's
- Shadow display memory gives full freedom in segment update
- ASCII character mapping
- Swap capability option on segment and/or common terminal buses
- Supports from static up to 1/4 duty
- Supports static and 1/3 bias
- LCD driver active in power save mode for low power operation
- Software selectable low power waveform
- Flexible selection of frame frequency
- Programmable blink mode and frequency on two segment terminals
- Uses Only 32 kHz RTC clock source
- On-chip LCD power supply
- Software contrast adjustment control
- Equal source and sink capability to Increase glass life time
- Extended interrupt mode for display update or wake-up from sleep mode

28.2 Overview

The LCD controller is intended for monochrome passive liquid crystal display (LCD) with up to 4 Common terminals and up to 40 Segments terminals. If the application does not need all the LCD segments available on the XMEGA, up to 16 of the unused LCD pins can be used as general purpose I/O pins.

The LCD controller can be clocked by an internal or an external asynchronous 32kHz clock source. This 32kHz oscillator source selection is the same as for the real time counter (RTC).

Dedicated Low Power Waveform, Contrast Control, Extended Interrupt Mode, Selectable Frame Frequency and Blink functionality are supported to offload the CPU, reduce interrupts and reduce power consumption.

To reduce hardware design complexity, the LCD includes integrated LCD buffers, an integrated power supply voltage and an innovative SWAP mode. Using SWAP mode, the hardware designers have more flexibility during board layout as they can rearrange the pin sequence on Segment and/or Common Terminal Buses.

Figure 28-1. LCD overview

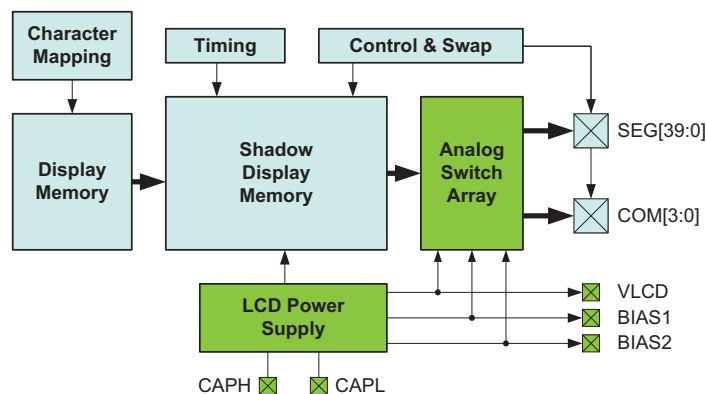

29. ADC – 12-bit Analog to Digital Converter

29.1 Features

- Two Analog to Digital Converters (ADCs)
- 12-bit resolution
- Up to 300 thousand samples per second
 - Down to 2.3 μ s conversion time with 8-bit resolution
 - Down to 3.35 μ s conversion time with 12-bit resolution
- Differential and single-ended input
 - Up to 16 single-ended inputs
 - 16x4 differential inputs without gain
 - 16x4 differential input with gain
- Built-in differential gain stage
 - 1/2x, 1x, 2x, 4x, 8x, 16x, 32x, and 64x gain options
- Single, continuous and scan conversion options
- Three internal inputs
 - Internal temperature sensor
 - V_{CC} voltage divided by 10
 - 1.1V bandgap voltage
- Internal and external reference options
- Compare function for accurate monitoring of user defined thresholds
- Optional event triggered conversion for accurate timing
- Optional DMA transfer of conversion results
- Optional interrupt/event on compare result

29.2 Overview

The ADC converts analog signals to digital values. The ADC has 12-bit resolution and is capable of converting up to 300 thousand samples per second (KSPS). The input selection is flexible, and both single-ended and differential measurements can be done. For differential measurements, an optional gain stage is available to increase the dynamic range. In addition, several internal signal inputs are available. The ADC can provide both signed and unsigned results.

The ADC measurements can either be started by application software or an incoming event from another peripheral in the device. The ADC measurements can be started with predictable timing, and without software intervention. It is possible to use DMA to move ADC results directly to memory or peripherals when conversions are done.

Both internal and external reference voltages can be used. An integrated temperature sensor is available for use with the ADC. The output from the $V_{CC}/10$ and the bandgap voltage can also be measured by the ADC.

The ADC has a compare function for accurate monitoring of user defined thresholds with minimum software intervention required.

Figure 29-1. ADC overview

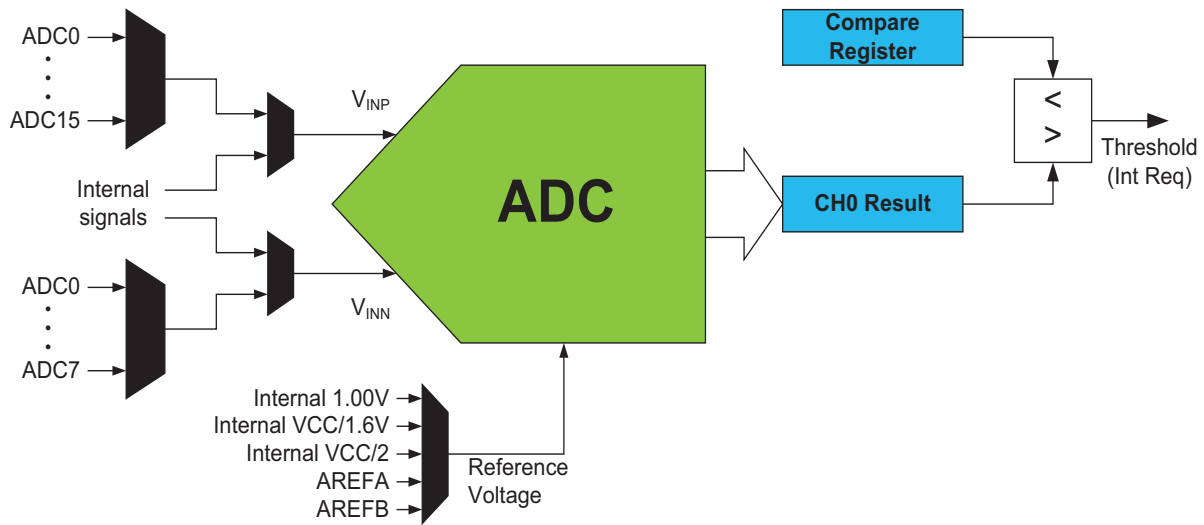

The ADC may be configured for 8- or 12-bit result, reducing the minimum conversion time (propagation delay) from 3.35 μ s for 12-bit to 2.3 μ s for 8-bit result.

ADC conversion results are provided left- or right adjusted with optional '1' or '0' padding. This eases calculation when the result is represented as a signed integer (signed 16-bit number).

PORTA and PORTB each has one ADC. Notation of these peripherals are ADCA and ADCB, respectively.

30. AC – Analog Comparator

30.1 Features

- Four Analog Comparators (AC)
- Selectable hysteresis
 - No
 - Small
 - Large
- Analog comparator output available on pin
- Flexible input selection
 - All pins on the port
 - Bandgap reference voltage
 - A 64-level programmable voltage scaler of the internal V_{CC} voltage
- Interrupt and event generation on:
 - Rising edge
 - Falling edge
 - Toggle
- Window function interrupt and event generation on:
 - Signal above window
 - Signal inside window
 - Signal below window
- Constant current source with configurable output pin selection

30.2 Overview

The analog comparator (AC) compares the voltage levels on two inputs and gives a digital output based on this comparison. The analog comparator may be configured to generate interrupt requests and/or events upon several different combinations of input change.

One important property of the analog comparator's dynamic behavior is the hysteresis. This parameter may be adjusted in order to achieve the optimal operation for each application.

The input selection includes analog port pins, several internal signals, and a 64-level programmable voltage scaler. The analog comparator output state can also be output on a pin for use by external devices.

A constant current source can be enabled and output on a selectable pin. This can be used to replace, for example, external resistors used to charge capacitors in capacitive touch sensing applications.

The analog comparators are always grouped in pairs on each port. These are called analog comparator 0 (AC0) and analog comparator 1 (AC1). They have identical behavior, but separate control registers. Used as pair, they can be set in window mode to compare a signal to a voltage range instead of a voltage level.

PORTA and PORTB each has one AC pair. Notations are ACA and ACB, respectively.

Figure 30-1. Analog comparator overview

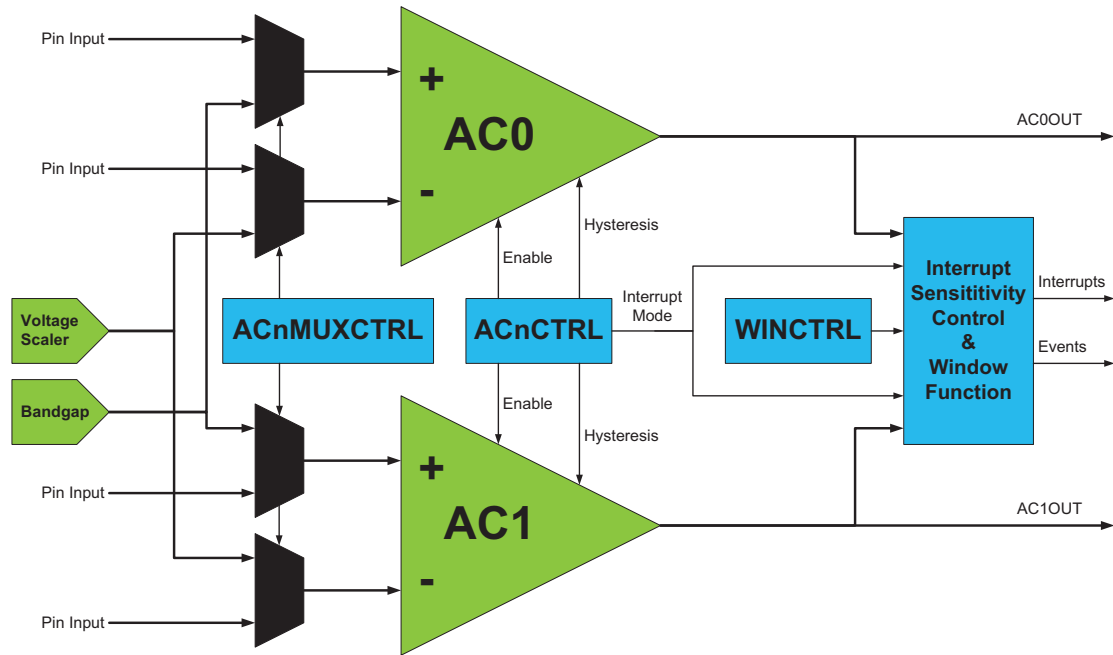

The window function is realized by connecting the external inputs of the two analog comparators in a pair as shown in [Figure 30-2..](#)

Figure 30-2. Analog comparator window function

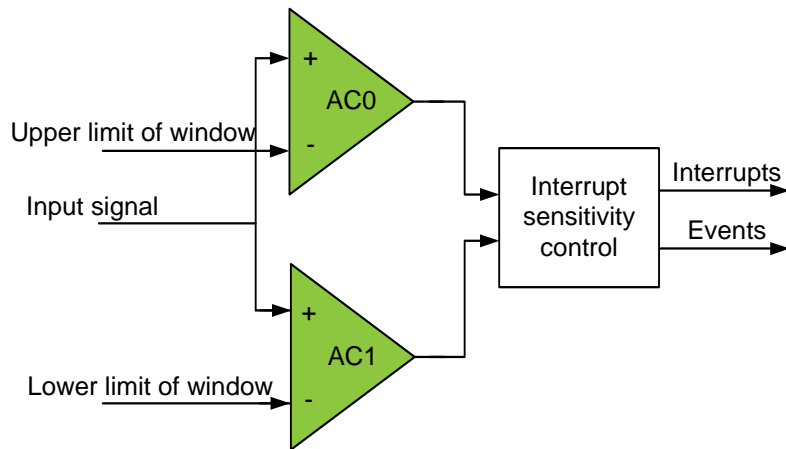

31. Programming and Debugging

31.1 Features

- Programming
 - External programming through PDI or JTAG interfaces
 - Minimal protocol overhead for fast operation
 - Built-in error detection and handling for reliable operation
 - Boot loader support for programming through any communication interface
- Debugging
 - Nonintrusive, real-time, on-chip debug system
 - No software or hardware resources required from device except pin connection
 - Program flow control
 - Go, Stop, Reset, Step Into, Step Over, Step Out, Run-to-Cursor
 - Unlimited number of user program breakpoints
 - Unlimited number of user data breakpoints, break on:
 - Data location read, write, or both read and write
 - Data location content equal or not equal to a value
 - Data location content is greater or smaller than a value
 - Data location content is within or outside a range
 - No limitation on device clock frequency
- Program and Debug Interface (PDI)
 - Two-pin interface for external programming and debugging
 - Uses the Reset pin and a dedicated pin
 - No I/O pins required during programming or debugging
- JTAG interface
 - Four-pin, IEEE Std. 1149.1 compliant interface for programming and debugging
 - Boundary scan capabilities according to IEEE Std. 1149.1 (JTAG)

31.2 Overview

The Program and Debug Interface (PDI) is an Atmel proprietary interface for external programming and on-chip debugging of a device.

The PDI supports fast programming of nonvolatile memory (NVM) spaces; flash, EEPROM, fuses, lock bits, and the user signature row.

Debug is supported through an on-chip debug system that offers nonintrusive, real-time debug. It does not require any software or hardware resources except for the device pin connection. Using the Atmel tool chain, it offers complete program flow control and support for an unlimited number of program and complex data breakpoints. Application debug can be done from a C or other high-level language source code level, as well as from an assembler and disassembler level.

Programming and debugging can be done through two physical interfaces. The primary one is the PDI physical layer, which is available on all devices. This is a two-pin interface that uses the Reset pin for the clock input (PDI_CLK) and one other dedicated pin for data input and output (PDI_DATA). A JTAG interface is also available on most devices, and this can be used for programming and debugging through the four-pin JTAG interface. The JTAG interface is IEEE Std. 1149.1 compliant, and supports boundary scan. Any external programmer or on-chip debugger/emulator can be directly connected to either of these interfaces. Unless otherwise stated, all references to the PDI assume access through the PDI physical layer.

32. Pinout and Pin Functions

The device pinout is shown in “[Pinout/Block Diagram](#)” on page 3. In addition to general purpose I/O functionality, each pin can have several alternate functions. This will depend on which peripheral is enabled and connected to the actual pin. Only one of the pin functions can be used at time.

32.1 Alternate Pin Function Description

The tables below show the notation for all pin functions available and describe its function.

32.1.1 Operation/Power Supply

VCC	Digital supply voltage
AVCC	Analog supply voltage
GND	Ground
AGND	Analog Ground

32.1.2 Port Interrupt functions

SYNC	Port pin with full synchronous and limited asynchronous interrupt function
ASYNC	Port pin with full synchronous and full asynchronous interrupt function

32.1.3 Analog functions

ACn	Analog Comparator input pin n
ACnOUT	Analog Comparator n Output
ADCn	Analog to Digital Converter input pin n
AREF	Analog Reference input pin

32.1.4 LCD functions

SEGn	LCD Segment Drive Output n
COMn	LCD Common Drive Output n
VLCD	LCD Voltage Multiplier Output
BIAS2	LCD Intermediate Voltage 2 Output ($VLCD * 2/3$)
BIAS1	LCD Intermediate Voltage 1 Output ($VLCD * 1/3$)
CAPH	LCD High End Of Flying Capacitor
CAPL	LCD Low End Of Flying Capacitor

32.1.5 Timer/Counter and AWEX functions

OCnxLS	Output Compare Channel x Low Side for Timer/Counter n
OCnxHS	Output Compare Channel x High Side for Timer/Counter n

32.1.6 Communication functions

SCL	Serial Clock for TWI
SDA	Serial Data for TWI
SCLIN	Serial Clock In for TWI when external driver interface is enabled
SCLOUT	Serial Clock Out for TWI when external driver interface is enabled
SDAIN	Serial Data In for TWI when external driver interface is enabled
SDAOUT	Serial Data Out for TWI when external driver interface is enabled
XCKn	Transfer Clock for USART n
RXDn	Receiver Data for USART n
TXDn	Transmitter Data for USART n
SS	Slave Select for SPI
MOSI	Master Out Slave In for SPI
MISO	Master In Slave Out for SPI
SCK	Serial Clock for SPI
D-	Data- for USB
D+	Data+ for USB

32.1.7 Oscillators, Clock and Event

TOSCn	Timer Oscillator pin n
XTALn	Input/Output for Oscillator pin n
CLKOUT	Peripheral Clock Output
EVOUT	Event Channel 0 Output
RTCOUT	RTC Clock Source Output

32.1.8 Debug/System functions

RESET	Reset pin
PDI_CLK	Program and Debug Interface Clock pin
PDI_DATA	Program and Debug Interface Data pin
TCK	JTAG Test Clock
TDI	JTAG Test Data In
TDO	JTAG Test Data Out
TMS	JTAG Test Mode Select

32.2 Alternate Pin Functions

The tables below show the primary/default function for each pin on a port in the first column, the pin number in the second column, and then all alternate pin functions in the remaining columns. The head row shows what peripheral that enable and use the alternate pin functions.

For better flexibility, some alternate functions also have selectable pin locations for their functions, this is noted under the the first table where this apply.

Table 32-1. Port A - Alternate functions

PORT A	PIN #	INTERRUPT	ADCA POS/GAIN POS	ADCB POS/GAIN POS	ADCA NEG	ADCA GAINNEG	ACA POS	ACA NEG	ACA OUT	REFA
PA0	82	SYNC	ADC0	ADC8	ADC0		AC0	AC0		AREF
PA1	83	SYNC	ADC1	ADC9	ADC1		AC1	AC1		
PA2	84	SYNC/ASYN C	ADC2	ADC10	ADC2		AC2			
PA3	85	SYNC	ADC3	ADC11	ADC3		AC3	AC3		
PA4	86	SYNC	ADC4	ADC12		ADC4	AC4			
PA5	87	SYNC	ADC5	ADC13		ADC5	AC5	AC5		
PA6	88	SYNC	ADC6	ADC14		ADC6	AC6		AC1OUT	
PA7	89	SYNC	ADC7	ADC15		ADC7		AC7	AC0OUT	

Table 32-2. Port B - Alternate functions

PORT B	PIN #	INTERRUPT	ADCA POS/GAIN POS	ADCB POS/GAIN POS	ADCB NEG	ADCB GAINNEG	ACB POS	ACB NEG	ACB OUT	REFB	JTAG
AGND	90										
AVDD	91										
PB0	92	SYNC	ADC8	ADC0	ADC0		AC0	AC0		AREF	
PB1	93	SYNC	ADC9	ADC1	ADC1		AC1	AC1			
PB2	94	SYNC/ASYN C	ADC10	ADC2	ADC2		AC2				
PB3	95	SYNC	ADC11	ADC3	ADC3		AC3	AC3			
PB4	96	SYNC	ADC12	ADC4		ADC4	AC4				TMS
PB5	97	SYNC	ADC13	ADC5		ADC5	AC5	AC5			TDI
PB6	98	SYNC	ADC14	ADC6		ADC6	AC6		AC1OUT		TCK
PB7	99	SYNC	ADC15	ADC7		ADC7		AC7	AC0OUT		TDO

Table 32-3. Port C - Alternate functions.

PORT C	PIN #	INTERRUPT	TCC0 ⁽¹⁾	AWEXC	TCC1	USARTC0 ⁽²⁾	SPIC ⁽³⁾	TWIC	EXTCLK	CLOCKOUT ⁽⁴⁾	EVENTOUT ⁽⁵⁾
GND	100										
VCC	1										
PC0	2	SYNC	OC0A	$\overline{OC0ALS}$				SDA	EXTCLKC0		
PC1	3	SYNC	OC0B	OC0AHS		XCK0		SCL	EXTCLKC1		
PC2	4	SYNC/ASYNC	OC0C	$\overline{OC0BLS}$		RXD0			EXTCLKC2		
PC3	5	SYNC	OC0D	OC0BHS		TXD0			EXTCLKC3		
PC4	6	SYNC		$\overline{OC0CLS}$	OC1A		\overline{SS}		EXTCLKC4		
PC5	7	SYNC		OC0CHS	OC1B		MOSI		EXTCLKC5		
PC6	8	SYNC		$\overline{OC0DLS}$			MISO		EXTCLKC6	RTCOUT	
PC7	9	SYNC		OC0DHS			SCK		EXTCLKC7	clk _{PER}	EVOUT

- Notes:
1. Pin mapping of all TC0 can optionally be moved to high nibble of port.
 2. Pin mapping of all USART0 can optionally be moved to high nibble of port.
 3. Pins MOSI and SCK for all SPI can optionally be swapped.
 4. CLKOUT can optionally be moved between port C and E and between pin 4 and 7.
 5. EVOUT can optionally be moved between port C and E and between pin 4 and 7.

Table 32-4. Port D - Alternate functions.

PORT D	PIN #	INTERRUPT	USB D
GND	10		
VCC	11		
PD0	12	SYNC	D-
PD1	13	SYNC	D+
PD2	14	SYNC/ASYNC	

Table 32-5. Program and Debug functions.

PROG	PIN #	INTERRUPT	PROG
RESET	15		PDI_CLK
PDI	16		PDI_DATA
GND	17		
VCC	18		

Table 32-6. Port E - Alternate functions.

PORT E	PIN #	INTERRUPT	TCE0 ⁽¹⁾	USARTE0 ⁽²⁾	CLOCKOUT ⁽⁴⁾	EVENTOUT ⁽⁵⁾	Alternate TOSC
PE0	19	SYNC	OC0A				
PE1	20	SYNC	OC0B	XCK0			
PE2	21	SYNC/ASYNC	OC0C	RXD0			
PE3	22	SYNC	OC0D	TXD0			
PE4	23	SYNC					
PE5	24	SYNC					
PE6	25	SYNC					TOSC2
PE7	26	SYNC			clk _{PER}	EVOUT	TOSC1

Table 32-7. LCD

LCD ⁽¹⁾⁽²⁾	PIN #	INTERRUPT ⁽¹⁾	GPIO ⁽¹⁾	BLINK ⁽¹⁾
GND	27			
VCC	28			
SEG39	29	SYNC	PG0	
SEG38	30	SYNC	PG1	
SEG37	31	SYNC/ASYNC	PG2	
SEG36	32	SYNC	PG3	
SEG35	33	SYNC	PG4	
SEG34	34	SYNC	PG5	
SEG33	35	SYNC	PG6	
SEG32	36	SYNC	PG7	
SEG31	37	SYNC	PM0	
SEG30	38	SYNC	PM1	
SEG29	39	SYNC/ASYNC	PM2	
SEG28	40	SYNC	PM3	
SEG27	41	SYNC	PM4	
SEG26	42	SYNC	PM5	
SEG25	43	SYNC	PM6	
SEG24	44	SYNC	PM7	
SEG23	45			
SEG22	46			
SEG21	47			
SEG20	48			
SEG19	49			

LCD ⁽¹⁾⁽²⁾	PIN #	INTERRUPT ⁽¹⁾	GPIO ⁽¹⁾	BLINK ⁽¹⁾
SEG18	50			
SEG17	51			
SEG16	52			
SEG15	53			
SEG14	54			
SEG13	55			
SEG12	56			
SEG11	57			
SEG10	58			
SEG9	59			
SEG8	60			
SEG7	61			
SEG6	62			
SEG5	63			
SEG4	64			
SEG3	65			
SEG2	66			
SEG1	67			BLINK
SEG0	68			BLINK
GND	69			
VCC	70			
BIAS1	71			
BIAS2	72			
VLCD	73			
CAPL	74			
CAPH	75			
COM0	76			
COM1	77			
COM2	78			
COM3	79			

- Notes:
1. Pin mapping of all Segment terminals (SEGn) can be optionnaly swapped. Interrupt, GPIO and Blink functions will be automatically swapped.
 2. Pin mapping of all Common terminals (COMn) can be optionnaly swapped.

Table 32-8. Port R- Alternate functions.

PORT R	PIN #	INTERRUPT	XTAL	TOSC
PR0	80	SYNC	XTAL2	TOSC2
PR1	81	SYNC	XTAL1	TOSC1

33. Peripheral Module Address Map

The address maps show the base address for each peripheral and module in XMEGA B1. For complete register description and summary for each peripheral module, refer to the XMEGA B Manual.

Table 33-1. Peripheral module address map.

Base address	Name	Description
0x0000	GPIO	General Purpose IO Registers
0x0010	VPORT0	Virtual Port 0
0x0014	VPORT1	Virtual Port 1
0x0018	VPORT2	Virtual Port 2
0x001C	VPORT3	Virtual Port 3
0x0030	CPU	CPU
0x0040	CLK	Clock Control
0x0048	SLEEP	Sleep Controller
0x0050	OSC	Oscillator Control
0x0060	DFLLRC32M	DFLL for the 32MHz Internal Oscillator
0x0068	DFLLRC2M	DFLL for the 2MHz Internal Oscillator
0x0070	PR	Power Reduction
0x0078	RST	Reset Controller
0x0080	WDT	Watch-Dog Timer
0x0090	MCU	MCU Control
0x00A0	PMIC	Programmable Multilevel Interrupt Controller
0x00B0	PORTCFG	Port Configuration
0x00C0	AES	AES Module
0x00D0	CRC	CRC Module
0x0100	DMA	DMA Controller
0x0180	EVSYS	Event System
0x01C0	NVM	Non Volatile Memory (NVM) Controller
0x0200	ADCA	Analog to Digital Converter on port A
0x0240	ADCB	Analog to Digital Converter on port B
0x0380	ACA	Analog Comparator pair on port A
0x0390	ACB	Analog Comparator pair on port B
0x0400	RTC	Real Time Counter
0x0480	TWIC	Two Wire Interface on port C
0x04C0	USB	USB Device
0x0600	PORTA	Port A
0x0620	PORTB	Port B

Base address	Name	Description
0x0640	PORTC	Port C
0x0660	PORTD	Port D
0x0680	PORTE	Port E
0x06C0	PORTG	Port G
0x0760	PORTM	Port M
0x07E0	PORTR	Port R
0x0800	TCC0	Timer/Counter 0 on port C
0x0840	TCC1	Timer/Counter 1 on port C
0x0880	AWEXC	Advanced Waveform Extension on port C
0x0890	HIRESC	High Resolution Extension on port C
0x08A0	USARTC0	USART 0 on port C
0x08C0	SPIC	Serial Peripheral Interface on port C
0x08F8	IRCOM	Infrared Communication Module
0x0A00	TCE0	Timer/Counter 0 on port E
0x0AA0	USARTE0	USART 0 on port E
0x0D00	LCD	Liquid Crystal Display

34. Instruction Set Summary

Mnemonics	Operands	Description	Operation	Flags	#Clocks
Arithmetic and Logic Instructions					
ADD	Rd, Rr	Add without Carry	$Rd \leftarrow Rd + Rr$	Z,C,N,V,S,H	1
ADC	Rd, Rr	Add with Carry	$Rd \leftarrow Rd + Rr + C$	Z,C,N,V,S,H	1
ADIW	Rd, K	Add Immediate to Word	$Rd \leftarrow Rd + 1:Rd + K$	Z,C,N,V,S	2
SUB	Rd, Rr	Subtract without Carry	$Rd \leftarrow Rd - Rr$	Z,C,N,V,S,H	1
SUBI	Rd, K	Subtract Immediate	$Rd \leftarrow Rd - K$	Z,C,N,V,S,H	1
SBC	Rd, Rr	Subtract with Carry	$Rd \leftarrow Rd - Rr - C$	Z,C,N,V,S,H	1
SBCI	Rd, K	Subtract Immediate with Carry	$Rd \leftarrow Rd - K - C$	Z,C,N,V,S,H	1
SBIW	Rd, K	Subtract Immediate from Word	$Rd + 1:Rd \leftarrow Rd + 1:Rd - K$	Z,C,N,V,S	2
AND	Rd, Rr	Logical AND	$Rd \leftarrow Rd \bullet Rr$	Z,N,V,S	1
ANDI	Rd, K	Logical AND with Immediate	$Rd \leftarrow Rd \bullet K$	Z,N,V,S	1
OR	Rd, Rr	Logical OR	$Rd \leftarrow Rd \vee Rr$	Z,N,V,S	1
ORI	Rd, K	Logical OR with Immediate	$Rd \leftarrow Rd \vee K$	Z,N,V,S	1
EOR	Rd, Rr	Exclusive OR	$Rd \leftarrow Rd \oplus Rr$	Z,N,V,S	1
COM	Rd	One's Complement	$Rd \leftarrow \$FF - Rd$	Z,C,N,V,S	1
NEG	Rd	Two's Complement	$Rd \leftarrow \$00 - Rd$	Z,C,N,V,S,H	1
SBR	Rd,K	Set Bit(s) in Register	$Rd \leftarrow Rd \vee K$	Z,N,V,S	1
CBR	Rd,K	Clear Bit(s) in Register	$Rd \leftarrow Rd \bullet (\$FFh - K)$	Z,N,V,S	1
INC	Rd	Increment	$Rd \leftarrow Rd + 1$	Z,N,V,S	1
DEC	Rd	Decrement	$Rd \leftarrow Rd - 1$	Z,N,V,S	1
TST	Rd	Test for Zero or Minus	$Rd \leftarrow Rd \bullet Rd$	Z,N,V,S	1
CLR	Rd	Clear Register	$Rd \leftarrow Rd \oplus Rd$	Z,N,V,S	1
SER	Rd	Set Register	$Rd \leftarrow \$FF$	None	1
MUL	Rd,Rr	Multiply Unsigned	$R1:R0 \leftarrow Rd \times Rr$ (UU)	Z,C	2
MULS	Rd,Rr	Multiply Signed	$R1:R0 \leftarrow Rd \times Rr$ (SS)	Z,C	2
MULSU	Rd,Rr	Multiply Signed with Unsigned	$R1:R0 \leftarrow Rd \times Rr$ (SU)	Z,C	2
FMUL	Rd,Rr	Fractional Multiply Unsigned	$R1:R0 \leftarrow Rd \times Rr \ll 1$ (UU)	Z,C	2
FMULS	Rd,Rr	Fractional Multiply Signed	$R1:R0 \leftarrow Rd \times Rr \ll 1$ (SS)	Z,C	2
FMULSU	Rd,Rr	Fractional Multiply Signed with Unsigned	$R1:R0 \leftarrow Rd \times Rr \ll 1$ (SU)	Z,C	2
DES	K	Data Encryption	if (H = 0) then R15:R0 \leftarrow Encrypt(R15:R0, K) else if (H = 1) then R15:R0 \leftarrow Decrypt(R15:R0, K)		1/2
Branch instructions					
RJMP	k	Relative Jump	$PC \leftarrow PC + k + 1$	None	2
IJMP		Indirect Jump to (Z)	$PC(15:0) \leftarrow Z,$ $PC(21:16) \leftarrow 0$	None	2
EIJMP		Extended Indirect Jump to (Z)	$PC(15:0) \leftarrow Z,$ $PC(21:16) \leftarrow EIND$	None	2
JMP	k	Jump	$PC \leftarrow k$	None	3
RCALL	k	Relative Call Subroutine	$PC \leftarrow PC + k + 1$	None	2 / 3 ⁽¹⁾

Mnemonics	Operands	Description	Operation	Flags	#Clocks
ICALL		Indirect Call to (Z)	PC(15:0) ← Z, PC(21:16) ← 0	None	2 / 3 ⁽¹⁾
EICALL		Extended Indirect Call to (Z)	PC(15:0) ← Z, PC(21:16) ← EIND	None	3 ⁽¹⁾
CALL	k	call Subroutine	PC ← k	None	3 / 4 ⁽¹⁾
RET		Subroutine Return	PC ← STACK	None	4 / 5 ⁽¹⁾
RETI		Interrupt Return	PC ← STACK	I	4 / 5 ⁽¹⁾
CPSE	Rd,Rr	Compare, Skip if Equal	if (Rd = Rr) PC ← PC + 2 or 3	None	1 / 2 / 3
CP	Rd,Rr	Compare	Rd - Rr	Z,C,N,V,S,H	1
CPC	Rd,Rr	Compare with Carry	Rd - Rr - C	Z,C,N,V,S,H	1
CPI	Rd,K	Compare with Immediate	Rd - K	Z,C,N,V,S,H	1
SBRC	Rr, b	Skip if Bit in Register Cleared	if (Rr(b) = 0) PC ← PC + 2 or 3	None	1 / 2 / 3
SBRS	Rr, b	Skip if Bit in Register Set	if (Rr(b) = 1) PC ← PC + 2 or 3	None	1 / 2 / 3
SBIC	A, b	Skip if Bit in I/O Register Cleared	if (I/O(A,b) = 0) PC ← PC + 2 or 3	None	2 / 3 / 4
SBIS	A, b	Skip if Bit in I/O Register Set	if (I/O(A,b) = 1) PC ← PC + 2 or 3	None	2 / 3 / 4
BRBS	s, k	Branch if Status Flag Set	if (SREG(s) = 1) then PC ← PC + k + 1	None	1 / 2
BRBC	s, k	Branch if Status Flag Cleared	if (SREG(s) = 0) then PC ← PC + k + 1	None	1 / 2
BREQ	k	Branch if Equal	if (Z = 1) then PC ← PC + k + 1	None	1 / 2
BRNE	k	Branch if Not Equal	if (Z = 0) then PC ← PC + k + 1	None	1 / 2
BRCS	k	Branch if Carry Set	if (C = 1) then PC ← PC + k + 1	None	1 / 2
BRCC	k	Branch if Carry Cleared	if (C = 0) then PC ← PC + k + 1	None	1 / 2
BRSH	k	Branch if Same or Higher	if (C = 0) then PC ← PC + k + 1	None	1 / 2
BRLO	k	Branch if Lower	if (C = 1) then PC ← PC + k + 1	None	1 / 2
BRMI	k	Branch if Minus	if (N = 1) then PC ← PC + k + 1	None	1 / 2
BRPL	k	Branch if Plus	if (N = 0) then PC ← PC + k + 1	None	1 / 2
BRGE	k	Branch if Greater or Equal, Signed	if (N ⊕ V = 0) then PC ← PC + k + 1	None	1 / 2
BRLT	k	Branch if Less Than, Signed	if (N ⊕ V = 1) then PC ← PC + k + 1	None	1 / 2
BRHS	k	Branch if Half Carry Flag Set	if (H = 1) then PC ← PC + k + 1	None	1 / 2
BRHC	k	Branch if Half Carry Flag Cleared	if (H = 0) then PC ← PC + k + 1	None	1 / 2
BRTS	k	Branch if T Flag Set	if (T = 1) then PC ← PC + k + 1	None	1 / 2
BRTC	k	Branch if T Flag Cleared	if (T = 0) then PC ← PC + k + 1	None	1 / 2
BRVS	k	Branch if Overflow Flag is Set	if (V = 1) then PC ← PC + k + 1	None	1 / 2
BRVC	k	Branch if Overflow Flag is Cleared	if (V = 0) then PC ← PC + k + 1	None	1 / 2
BRIE	k	Branch if Interrupt Enabled	if (I = 1) then PC ← PC + k + 1	None	1 / 2
BRID	k	Branch if Interrupt Disabled	if (I = 0) then PC ← PC + k + 1	None	1 / 2
Data transfer instructions					
MOV	Rd, Rr	Copy Register	Rd ← Rr	None	1
MOVW	Rd, Rr	Copy Register Pair	Rd+1:Rd ← Rr+1:Rr	None	1
LDI	Rd, K	Load Immediate	Rd ← K	None	1

Mnemonics	Operands	Description	Operation	Flags	#Clocks
LDS	Rd, k	Load Direct from data space	Rd ← (k)	None	2 ⁽¹⁾⁽²⁾
LD	Rd, X	Load Indirect	Rd ← (X)	None	1 ⁽¹⁾⁽²⁾
LD	Rd, X+	Load Indirect and Post-Increment	Rd ← (X) X ← X + 1	None	1 ⁽¹⁾⁽²⁾
LD	Rd, -X	Load Indirect and Pre-Decrement	X ← X - 1, Rd ← (X)	None	2 ⁽¹⁾⁽²⁾
LD	Rd, Y	Load Indirect	Rd ← (Y)	None	1 ⁽¹⁾⁽²⁾
LD	Rd, Y+	Load Indirect and Post-Increment	Rd ← (Y) Y ← Y + 1	None	1 ⁽¹⁾⁽²⁾
LD	Rd, -Y	Load Indirect and Pre-Decrement	Y ← Y - 1, Rd ← (Y)	None	2 ⁽¹⁾⁽²⁾
LDD	Rd, Y+q	Load Indirect with Displacement	Rd ← (Y + q)	None	2 ⁽¹⁾⁽²⁾
LD	Rd, Z	Load Indirect	Rd ← (Z)	None	1 ⁽¹⁾⁽²⁾
LD	Rd, Z+	Load Indirect and Post-Increment	Rd ← (Z), Z ← Z + 1	None	1 ⁽¹⁾⁽²⁾
LD	Rd, -Z	Load Indirect and Pre-Decrement	Z ← Z - 1, Rd ← (Z)	None	2 ⁽¹⁾⁽²⁾
LDD	Rd, Z+q	Load Indirect with Displacement	Rd ← (Z + q)	None	2 ⁽¹⁾⁽²⁾
STS	k, Rr	Store Direct to Data Space	(k) ← Rr	None	2 ⁽¹⁾
ST	X, Rr	Store Indirect	(X) ← Rr	None	1 ⁽¹⁾
ST	X+, Rr	Store Indirect and Post-Increment	(X) ← Rr, X ← X + 1	None	1 ⁽¹⁾
ST	-X, Rr	Store Indirect and Pre-Decrement	X ← X - 1, (X) ← Rr	None	2 ⁽¹⁾
ST	Y, Rr	Store Indirect	(Y) ← Rr	None	1 ⁽¹⁾
ST	Y+, Rr	Store Indirect and Post-Increment	(Y) ← Rr, Y ← Y + 1	None	1 ⁽¹⁾
ST	-Y, Rr	Store Indirect and Pre-Decrement	Y ← Y - 1, (Y) ← Rr	None	2 ⁽¹⁾
STD	Y+q, Rr	Store Indirect with Displacement	(Y + q) ← Rr	None	2 ⁽¹⁾
ST	Z, Rr	Store Indirect	(Z) ← Rr	None	1 ⁽¹⁾
ST	Z+, Rr	Store Indirect and Post-Increment	(Z) ← Rr, Z ← Z + 1	None	1 ⁽¹⁾
ST	-Z, Rr	Store Indirect and Pre-Decrement	Z ← Z - 1, (Z) ← Rr	None	2 ⁽¹⁾
STD	Z+q, Rr	Store Indirect with Displacement	(Z + q) ← Rr	None	2 ⁽¹⁾
LPM		Load Program Memory	R0 ← (Z)	None	3
LPM	Rd, Z	Load Program Memory	Rd ← (Z)	None	3
LPM	Rd, Z+	Load Program Memory and Post-Increment	Rd ← (Z), Z ← Z + 1	None	3
ELPM		Extended Load Program Memory	R0 ← (RAMPZ:Z)	None	3
ELPM	Rd, Z	Extended Load Program Memory	Rd ← (RAMPZ:Z)	None	3
ELPM	Rd, Z+	Extended Load Program Memory and Post-Increment	Rd ← (RAMPZ:Z), Z ← Z + 1	None	3
SPM		Store Program Memory	(RAMPZ:Z) ← R1:R0	None	-
SPM	Z+	Store Program Memory and Post-Increment by 2	(RAMPZ:Z) ← R1:R0, Z ← Z + 2	None	-

Mnemonics	Operands	Description	Operation	Flags	#Clocks
IN	Rd, A	In From I/O Location	Rd ← I/O(A)	None	1
OUT	A, Rr	Out To I/O Location	I/O(A) ← Rr	None	1
PUSH	Rr	Push Register on Stack	STACK ← Rr	None	1 ⁽¹⁾
POP	Rd	Pop Register from Stack	Rd ← STACK	None	2 ⁽¹⁾
XCH	Z, Rd	Exchange RAM location	Temp ← Rd, Rd ← (Z), Z ← Temp	None	2
LAS	Z, Rd	Load and Set RAM location	Temp ← Rd, Rd ← (Z), Z ← Temp v (Z)	None	2
LAC	Z, Rd	Load and Clear RAM location	Temp ← Rd, Rd ← (Z), Z ← (\$FFh – Rd) • (Z)	None	2
LAT	Z, Rd	Load and Toggle RAM location	Temp ← Rd, Rd ← (Z), Z ← Temp ⊕ (Z)	None	2
Bit and bit-test instructions					
LSL	Rd	Logical Shift Left	Rd(n+1) ← Rd(n), Rd(0) ← 0, C ← Rd(7)	Z,C,N,V,H	1
LSR	Rd	Logical Shift Right	Rd(n) ← Rd(n+1), Rd(7) ← 0, C ← Rd(0)	Z,C,N,V	1
ROL	Rd	Rotate Left Through Carry	Rd(0) ← C, Rd(n+1) ← Rd(n), C ← Rd(7)	Z,C,N,V,H	1
ROR	Rd	Rotate Right Through Carry	Rd(7) ← C, Rd(n) ← Rd(n+1), C ← Rd(0)	Z,C,N,V	1
ASR	Rd	Arithmetic Shift Right	Rd(n) ← Rd(n+1), n=0..6	Z,C,N,V	1
SWAP	Rd	Swap Nibbles	Rd(3..0) ↔ Rd(7..4)	None	1
BSET	s	Flag Set	SREG(s) ← 1	SREG(s)	1
BCLR	s	Flag Clear	SREG(s) ← 0	SREG(s)	1
SBI	A, b	Set Bit in I/O Register	I/O(A, b) ← 1	None	1
CBI	A, b	Clear Bit in I/O Register	I/O(A, b) ← 0	None	1
BST	Rr, b	Bit Store from Register to T	T ← Rr(b)	T	1
BLD	Rd, b	Bit load from T to Register	Rd(b) ← T	None	1
SEC		Set Carry	C ← 1	C	1
CLC		Clear Carry	C ← 0	C	1
SEN		Set Negative Flag	N ← 1	N	1
CLN		Clear Negative Flag	N ← 0	N	1
SEZ		Set Zero Flag	Z ← 1	Z	1
CLZ		Clear Zero Flag	Z ← 0	Z	1
SEI		Global Interrupt Enable	I ← 1	I	1
CLI		Global Interrupt Disable	I ← 0	I	1
SES		Set Signed Test Flag	S ← 1	S	1
CLS		Clear Signed Test Flag	S ← 0	S	1

Mnemonics	Operands	Description	Operation	Flags	#Clocks
SEV		Set Two's Complement Overflow	V ← 1	V	1
CLV		Clear Two's Complement Overflow	V ← 0	V	1
SET		Set T in SREG	T ← 1	T	1
CLT		Clear T in SREG	T ← 0	T	1
SEH		Set Half Carry Flag in SREG	H ← 1	H	1
CLH		Clear Half Carry Flag in SREG	H ← 0	H	1
MCU control instructions					
BREAK		Break	(See specific descr. for BREAK)	None	1
NOP		No Operation		None	1
SLEEP		Sleep	(see specific descr. for Sleep)	None	1
WDR		Watchdog Reset	(see specific descr. for WDR)	None	1

- Notes:
1. Cycle times for Data memory accesses assume internal memory accesses, and are not valid for accesses via the external RAM interface.
 2. One extra cycle must be added when accessing Internal SRAM.

35. Packaging information

35.1 100A

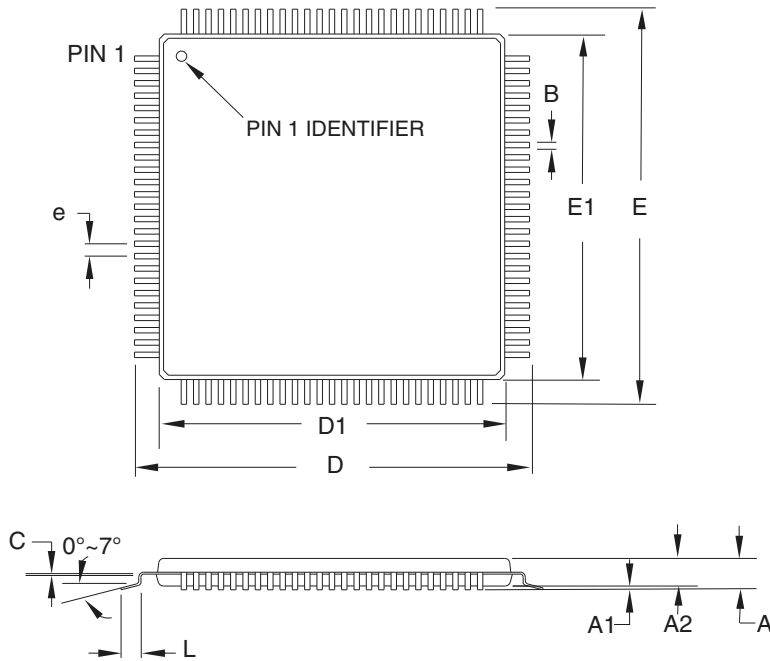

COMMON DIMENSIONS
(Unit of Measure = mm)

SYMBOL	MIN	NOM	MAX	NOTE
A	–	–	1.20	
A1	0.05	–	0.15	
A2	0.95	1.00	1.05	
D	15.75	16.00	16.25	
D1	13.90	14.00	14.10	Note 2
E	15.75	16.00	16.25	
E1	13.90	14.00	14.10	Note 2
B	0.17	–	0.27	
C	0.09	–	0.20	
L	0.45	–	0.75	
e	0.50 TYP			

Notes:

1. This package conforms to JEDEC reference MS-026, Variation AED.
2. Dimensions D1 and E1 do not include mold protrusion. Allowable protrusion is 0.25 mm per side. Dimensions D1 and E1 are maximum plastic body size dimensions including mold mismatch.
3. Lead coplanarity is 0.08 mm maximum.

2010-10-20

 Package Drawing Contact: packagedrawings@atmel.com	TITLE	DRAWING NO.	REV.
	100A , 100-lead, 14 x 14 mm Body Size, 1.0 mm Body Thickness, 0.5 mm Lead Pitch, Thin Profile Plastic Quad Flat Package (TQFP)	100A	D

35.2 7A1

DRAWINGS NOT SCALED

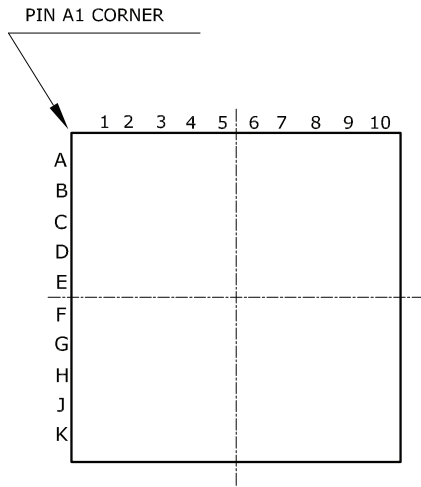

TOP VIEW

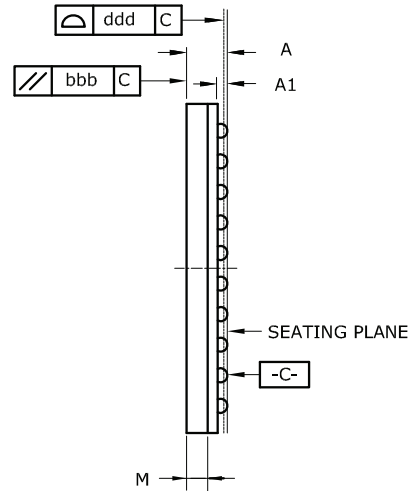

SIDE VIEW

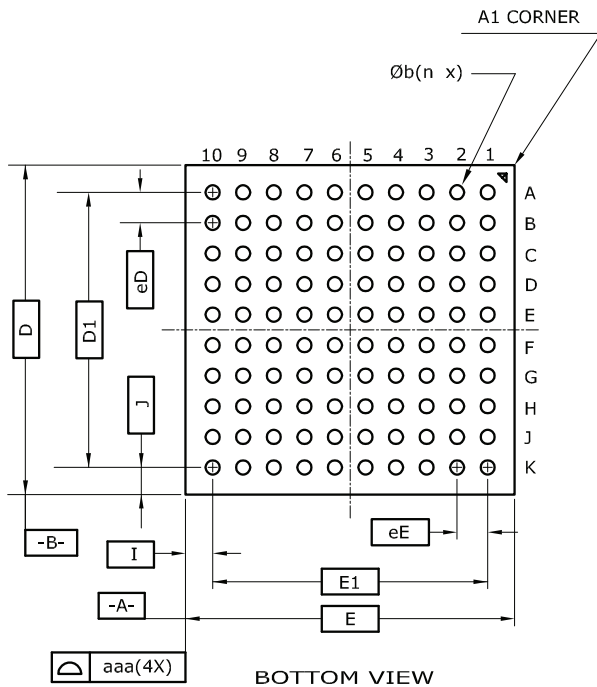

BOTTOM VIEW

COMMON DIMENSIONS
(Unit of Measure = mm)

SYMBOL	MIN	NOM	MAX	NOTE
A	-----	-----	1.00	
A1	0.160	-----	0.260	
E/D	7.00 / 7.00			
E1/D1	5.85 / 5.85			
I/J	0.575			
eD/eE	Ball pitch : 0.650			
b	0.270	-----	0.370	
M	Mold thickness : 0.450 ref			
aaa	Pack edge tolerance : 0.100			
bbb	Mold flatness : 0.100			
ddd	Copla : 0.080			
ball diam	0.300			
n	100			

- Notes :
1. No JEDEC Drawing Reference.
 2. Array as seen from the bottom of the package.
 3. Dimension A includes stand-off height A1, package body thickness, and lid height, but does not include attached features.
 4. Dimension b is measured at the maximum ball diameter, parallel to primary datum C.

12/21/2011

Atmel Package Drawing Contact:
packagedrawings@atmel.com

TITLE
7A, 100-ball (10x10 array), 0.65mm pitch, 7x7x1mm
Very Thin Fine-Pitch Ball Grid Array Package (VFPGA)

GPC	DRAWING NO.	REV.
CAF	7A	B

36. Electrical Characteristics

All typical values are measured at $T = 25^{\circ}\text{C}$ unless other temperature condition is given. All minimum and maximum values are valid across operating temperature and voltage unless other conditions are given.

36.1 Absolute Maximum Ratings

Stresses beyond those listed in [Table 36-1 on page 70](#) under may cause permanent damage to the device. This is a stress rating only and functional operation of the device at these or other conditions beyond those indicated in the operational sections of this specification is not implied. Exposure to absolute maximum rating conditions for extended periods may affect device reliability.

Table 36-1. Absolute maximum ratings.

Symbol	Parameter	Min.	Typ.	Max.	Units
VCC	Power supply voltage	-0.3		4	V
I _{VCC}	Current into a Vcc pin			200	mA
I _{GND}	Current out of a Gnd pin			200	mA
V _{PIN}	Pin voltage with respect to Gnd and VCC	-0.5		V _{cc} +0.5	V
I _{PIN}	I/O pin sink/source current	-25		25	mA
T _A	Storage temperature	-65		150	°C
T _J	Junction temperature			150	°C

36.2 General Operating Ratings

The device must operate within the ratings listed in [Table 36-2 on page 70](#) in order for all other electrical characteristics and typical characteristics of the device to be guaranteed and valid.

Table 36-2. General operating conditions.

Symbol	Parameter	Min.	Typ.	Max.	Units
VCC	Power supply voltage	1.60		3.6	V
AVCC	Power supply voltage	1.60		3.6	V
T _A	Temperature range	-40		85	°C
T _J	Junction temperature	-40		105	°C

Table 36-3. Operating voltage and frequency.

Symbol	Parameter	Condition	Min	Typ.	Max.	Units
Clk _{CPU}	CPU clock frequency	V _{CC} = 1.6V	0		12	MHz
		V _{CC} = 1.8V	0		12	
		V _{CC} = 2.7V	0		32	
		V _{CC} = 3.6V	0		32	

The maximum System clock frequency of the Atmel® AVR® XMEGA B1 devices is depending on V_{CC}. As shown in [Figure 36-1 on page 71](#) the Frequency vs. V_{CC} curve is linear between $1.8\text{V} < V_{CC} < 2.7\text{V}$.

Figure 36-1. Maximum Frequency vs. Vcc

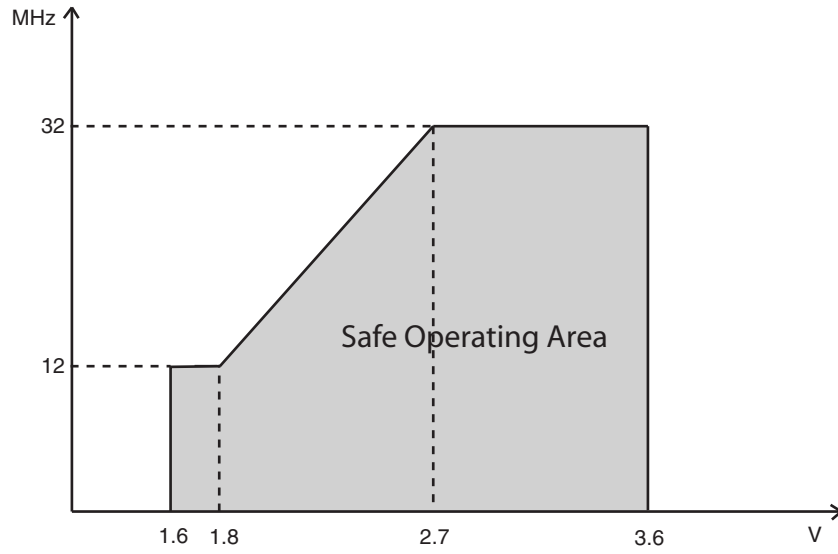

36.3 DC Characteristics

Table 36-4. Current Consumption for active and sleep modes.

Symbol	Parameter	Condition	Min	Typ	Max	Units	
I _{CC}	Active Power consumption ⁽¹⁾	32kHz, Ext. Clk	V _{CC} = 1.8V		150		μA
			V _{CC} = 3.0V		320		
		1MHz, Ext. Clk	V _{CC} = 1.8V		350		
			V _{CC} = 3.0V		700		
		2MHz, Ext. Clk	V _{CC} = 1.8V		650	800	
			V _{CC} = 3.0V		1.0	1.6	mA
	32MHz, Ext. Clk			10	15		
	Idle Power consumption ⁽¹⁾	32kHz, Ext. Clk	V _{CC} = 1.8V		4.0		μA
			V _{CC} = 3.0V		8.0		
		1MHz, Ext. Clk	V _{CC} = 1.8V		80		
			V _{CC} = 3.0V		150		
		2MHz, Ext. Clk	V _{CC} = 1.8V		160	250	
			V _{CC} = 3.0V		300	600	mA
	32MHz, Ext. Clk			4.7	7		
	Power-down power consumption	T = 25°C	V _{CC} = 3.0V		0.1	1.0	μA
				T = 85°C		2.1	
		WDT and Sampled BOD enabled, T = 25°C	V _{CC} = 1.8V		1.2	2.5	
		WDT and Sampled BOD enabled, T = 25°C	V _{CC} = 3.0V		1.3	3	
		WDT and Sampled BOD enabled, T=85°C			3.1	7	
	Power-save power consumption ⁽²⁾	RTC on ULP clock, WDT and sampled BOD enabled, T = 25°C	V _{CC} = 1.8V		1.2		μA
			V _{CC} = 3.0V		1.3		
		RTC on 1.024kHz low power 32.768kHz TOSC, T = 25°C	V _{CC} = 1.8V		0.8		
			V _{CC} = 3.0V		0.9		
		RTC from low power 32.768kHz TOSC, T = 25°C	V _{CC} = 1.8V		1.3		
V _{CC} = 3.0V				1.6			

Symbol	Parameter	Condition	Min	Typ	Max	Units	
I _{CC}	Power-save power consumption ⁽²⁾	RTC on ULP clock, WDT, sampled BOD and LCD enabled, and all pixels ON, T = 25°C	V _{CC} = 1.8V		4.6		μA
			V _{CC} = 3.0V		5.2		
		RTC on 1.024kHz low power 32.768kHz TOSC, LCD enabled and all pixels ON T = 25°C	V _{CC} = 1.8V		3.9		
			V _{CC} = 3.0V		4.3		
		RTC from low power 32.768kHz TOSC, LCD enabled and all pixels ON, T = 25°C	V _{CC} = 1.8V		4.0		
			V _{CC} = 3.0V		4.5		
	Reset power consumption	Current through $\overline{\text{RESET}}$ pin subtracted	V _{CC} = 3.0V		420		μA

- Notes:
1. All Power Reduction Registers set.
 2. Maximum limits are based on characterization and not tested in production.

Table 36-5. Current Consumption for modules and peripherals.

Symbol	Parameter	Condition ⁽¹⁾	Min	Typ	Max	Units	
I _{CC}	ULP oscillator			1.0		μA	
	32.768kHz int. oscillator			26		μA	
	2MHz int. oscillator				80		μA
		DFLL enabled with 32.768kHz int. osc. as reference			112		
	32MHz int. oscillator				255		μA
		DFLL enabled with 32.768kHz int. osc. as reference			444		
	PLL	Multiplication factor = 20x			316		μA
	Watchdog Timer				1		μA
	BOD	Continuous mode			126		μA
		Sampled mode, include ULP oscillator			1.3		
	LCD ⁽²⁾	No pixel load	Contrast min	All pixels OFF		3.0	μA
				100 pixels ON		3.0	
				All pixels ON		3.0	
			Contrast typ	All pixels OFF		3.3	
				100 pixels ON		3.4	
				All pixels ON		3.4	
		Contrast max	All pixels OFF		3.8		
			100 pixels ON		3.9		
			All pixels ON		3.9		
			All pixels ON		3.9		
22pF pixel load	Contrast typ	All pixels OFF		3.7			
		All pixels ON		4.3			
Internal 1.0V reference				100		μA	
Temperature sensor				100		μA	
ADC	16ksps VREF = Ext ref			1.3		mA	
		CURRLIMIT = LOW		1.1			
		CURRLIMIT = MEDIUM		1.0			
		CURRLIMIT = HIGH		0.9			
	75ksps VREF = Ext ref			1.7			
300ksps VREF = Ext ref				3.1			

Symbol	Parameter	Condition ⁽¹⁾	Min	Typ	Max	Units
I _{CC}	AC			440		μA
	DMA	615Kbps between I/O registers and SRAM		115		μA
	USART	Rx and Tx enabled, 9600 BAUD		9		μA
	Flash memory and EEPROM programming			4.4		mA

- Notes:
1. All parameters measured as the difference in current consumption between module enabled and disabled. All data at V_{CC} = 3.0V, CLKSYS = 1MHz External clock without prescaling, T = 25°C unless other conditions are given.
 2. LCD configuration: internal voltage generation, 32Hz low power frame rate, 1/3 bias, clocked by low power 32.768kHz TOSC.

36.4 Wake-up time from sleep modes

Table 36-6. Device wake-up time from sleep modes with various system clock sources.

Symbol	Parameter	Condition	Min	Typ	Max	Units	
t _{wakeup}	Wake-up time from Idle, Standby, and Extend Standby	External 2MHz clock		2		μs	
		32.768kHz internal oscillator		120			
		2MHz internal oscillator		2			
		32MHz internal oscillator		0.2			
	Wake-up time from Power-save and Power-down mode	External 2MHz clock			4.5		
		32.768kHz internal oscillator			320		
		2MHz internal oscillator			9		
		32MHz internal oscillator			5		

- Note:
1. The wake-up time is the time from the wake-up request is given until the peripheral clock is available on pin, see [Figure 36-2 on page 75](#). All peripherals and modules start execution from the first clock cycle, except the CPU that is halted for four clock cycles before program execution starts.

Figure 36-2. Wake-up time definition.

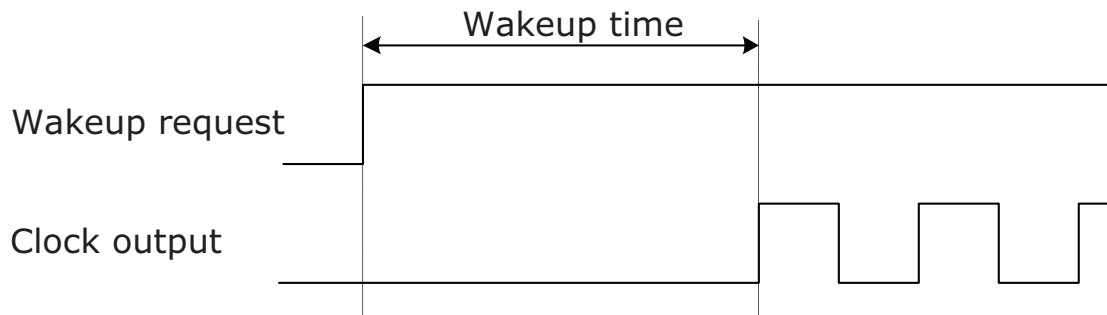

36.5 I/O Pin Characteristics

The I/O pins complies with the JEDEC LVTTTL and LVCMOS specification and the high- and low level input and output voltage limits reflect or exceed this specification.

Table 36-7. I/O Pin Characteristics.

Symbol	Parameter	Condition		Min	Typ	Max	Units
⁽¹⁾ I _{OH} / ⁽²⁾ I _{OL}	I/O pin source/sink current			-20		20	mA
V _{IH}	High Level Input Voltage	V _{CC} = 3.0 - 3.6V		0.6*V _{CC}		V _{CC} +0.3	V
		V _{CC} = 2.3 - 2.7V		0.6*V _{CC}		V _{CC} +0.3	
		V _{CC} = 1.6 - 2.3V		0.6*V _{CC}		V _{CC} +0.3	
V _{IL}	Low Level Input Voltage	V _{CC} = 3.0 - 3.6V		-0.3		0.4*V _{CC}	V
		V _{CC} = 2.3 - 2.7V		-0.3		0.4*V _{CC}	
		V _{CC} = 1.6 - 2.3V		-0.3		0.4*V _{CC}	
V _{OL}	Output Low Voltage GPIO	V _{CC} = 3.3V	I _{OL} = 15mA		0.4	0.76	V
		V _{CC} = 3.0V	I _{OL} = 10mA		0.26	0.64	
		V _{CC} = 1.8V	I _{OL} = 5mA		0.17	0.46	
V _{OH}	Output High Voltage GPIO	V _{CC} = 3.3V	I _{OH} = -8mA	2.6	2.8		V
		V _{CC} = 3.0V	I _{OH} = -6mA	2.1	2.6		
		V _{CC} = 1.8V	I _{OH} = -2mA	1.4	1.6		
I _{IN}	Input Leakage Current I/O pin				<0.01	1	μA
R _P	Pull/Buss keeper Resistor				25		kΩ
R _{RST}	Reset pin Pull-up Resistor				25		
⁽³⁾ t _r	Rise time	No load			4		ns
			slew rate limitation			7	

- Notes:
- The sum of all I_{OH} for PORTA and PORTB must not exceed 100mA.
The sum of all I_{OH} for PORTC, PORTD, PORTE and PDI must for each port not exceed 200mA.
The sum of all I_{OH} for PORTG and PORTM must not exceed 100mA.
The sum of all I_{OH} for PORTR must not exceed 100mA.
 - The sum of all I_{OL} for PORTA and PORTB must not exceed 100mA.
The sum of all I_{OL} for PORTC, PORTD, PORTE must for each port not exceed 200mA.
The sum of all I_{OL} for PORTG and PORTM must not exceed 100mA.
The sum of all I_{OL} PORTR must not exceed 100mA.
 - From design simulations

36.6 Liquid Crystal Display Characteristics

Table 36-8. Liquid crystal display characteristics.

Symbol	Parameter	Condition	Min	Typ	Max	Units
SEG	Segment terminal pins		0		40	
COM	Common terminal pins		0		4	
f_{Frame}	LCD frame frequency	$F(\text{clk}_{LCD})=32.768\text{kHz}$	31.25		512	Hz
C_{Flying}	Flying capacitor			100		nF
Contrast	Contrast adjustment		-0.5	0	0.5	V
V_{LCD}	LCD regulated voltages	$C_{Flying} = 0.1\mu\text{F}$ $0.1\mu\text{F}$ on V_{LCD} , BIAS2 and BIAS1 pins		3		V
BIAS2				$2*V_{LCD}/3$		
BIAS1				$V_{LCD}/3$		
R_{COM}	Common output impedance	COM0 to COM3 ⁽¹⁾	0.25	0.5	1	k Ω
R_{SEG}	Segment output impedance	SEG0 to SEG39 ⁽¹⁾	2	4	8	k Ω

Notes: 1. Applies to Static and 1/3 bias

36.7 ADC characteristics

Table 36-9. Power supply, reference and input range.

Symbol	Parameter	Condition	Min.	Typ.	Max.	Units
AVCC	Analog supply voltage		$V_{CC} - 0.3$		$V_{CC} + 0.3$	V
VREF	Reference voltage		1		$AV_{CC} - 0.6$	V
R_{in}	Input resistance	Switched			4.5	k Ω
C_{in}	Input capacitance	Switched			5	pF
R_{AREF}	Reference input resistance	(leakage only)		>10		M Ω
C_{AREF}	Reference input capacitance	Static load		7		pF
V_{in}	Input range		0		V_{REF}	V
V_{in}	Conversion range	Differential mode, $V_{inp} - V_{inn}$	$-0.95*V_{REF}$		$0.95*V_{REF}$	V
V_{in}	Conversion range	Single ended unsigned mode, V_{inp}	$-0.05*V_{REF}$		$0.95*V_{REF}$	V

Table 36-10. Clock and timing.

Symbol	Parameter	Condition	Min.	Typ.	Max.	Units
Clk_{ADC}	ADC Clock frequency	Maximum is 1/4 of Peripheral clock frequency	100		1800	kHz
		Measuring internal signals		125		
f_{ClkADC}	Sample rate		16		300	ksps

Symbol	Parameter	Condition	Min.	Typ.	Max.	Units
f_{ADC}	Sample rate	Current limitation (CURRLIMIT) off	16		300	ksps
		CURRLIMIT = LOW			250	
		CURRLIMIT = MEDIUM			150	
		CURRLIMIT = HIGH			50	
	Sampling Time	1/2 Clk _{ADC} cycle	0.25		5	μs
	Conversion time (latency)	(RES+2)/2+(GAIN !=0) RES (Resolution) = 8 or 12	6		10	Clk _{ADC} cycles
	Start-up time	ADC clock cycles		12	24	Clk _{ADC} cycles
	ADC settling time	After changing reference or input mode		7	7	Clk _{ADC} cycles

Table 36-11. Accuracy characteristics.

Symbol	Parameter	Condition ⁽²⁾		Min.	Typ.	Max.	Units
RES	Resolution	12-bit resolution	Differential	8	12	12	Bits
			Single ended signed	7	11	11	
			Single ended unsigned	8	12	12	
INL ⁽¹⁾	Integral non-linearity	Differential mode	16kSPS, VREF = 3V		1		lsb
			16kSPS, VREF = 1V		2		
			300kSPS, VREF = 3V		1		
			300kSPS, VREF = 1V		2		
		Single ended unsigned mode	16kSPS, VREF = 3.0V		1	1.5	
			16kSPS, VREF = 1.0V		2	3	
DNL ⁽¹⁾	Differential non-linearity	Differential mode	16kSPS, VREF = 3V		1		lsb
			16kSPS, VREF = 1V		2		
			300kSPS, VREF = 3V		1		
			300kSPS, VREF = 1V		2		
		Single ended unsigned mode	16kSPS, VREF = 3.0V		1	1.5	
			16kSPS, VREF = 1.0V		2	3	
Offset Error	Offset Error	Differential mode				8	mV
			Temperature drift			0.01	mV/K
			Operating voltage drift		0.25		mV/V

Symbol	Parameter	Condition ⁽²⁾	Min.	Typ.	Max.	Units	
	Gain Error	Differential mode	External reference		-5		mV
			AVCC/1.6		-5		
			AVCC/2.0		-6		
			Bandgap		±10		
			Temperature drift		0.02		mV/K
			Operating voltage drift		2		mV/V
	Gain Error	Single ended unsigned mode	External reference		-8		mV
			AVCC/1.6		-8		
			AVCC/2.0		-8		
			Bandgap		±10		
			Temperature drift		0.03		mV/K
			Operating voltage drift		2		mV/V

Notes: 1. Maximum numbers are based on characterisation and not tested in production, and valid for 10% to 90% input voltage range.
2. Unless otherwise noted all linearity, offset and gain error numbers are valid under the condition that external VREF is used.

Table 36-12. Gain stage characteristics.

Symbol	Parameter	Condition	Min.	Typ.	Max.	Units
R _{in}	Input resistance	Switched in normal mode		4.0		kΩ
C _{sample}	Input capacitance	Switched in normal mode		4.4		pF
	Signal range	Gain stage output	0		AV _{CC} - 0.3	V
	Propagation delay	ADC conversion rate		1		Clk _{ADC} cycles
	Clock rate	Same as ADC	100		1800	kHz
	Gain error	0.5x gain, normal mode		-1		%
		1x gain, normal mode		-1		
		8x gain, normal mode		-1		
		64x gain, normal mode		10		
	Offset error, input referred	0.5x gain, normal mode		10		mV
		1x gain, normal mode		10		
		8x gain, normal mode		-20		
		64x gain, normal mode		-150		

36.8 Analog Comparator Characteristics

Table 36-13. Analog comparator characteristics.

Symbol	Parameter	Condition	Min.	Typ.	Max.	Units
V_{off}	Input offset voltage			10		mV
I_{lk}	Input leakage current			<10	50	nA
	Input voltage range		0.1		$AV_{CC} - 0.1$	V
	AC startup time			50		μ s
V_{hys1}	Hysteresis, none	$V_{CC} = 1.6V - 3.6V$		0		mV
V_{hys2}	Hysteresis, small	$V_{CC} = 1.6V - 3.6V$		12		mV
V_{hys3}	Hysteresis, large	$V_{CC} = 1.6V - 3.6V$		28		mV
t_{delay}	Propagation delay	$V_{CC} = 3.0V, T = 85^{\circ}C$		22	30	ns
		$V_{CC} = 1.6V - 3.6V$		21	40	
	64-Level Voltage Scaler Integral non-linearity (INL)			0.3	0.5	lsb
	Current source accuracy after calibration			5		%
	Current source calibration range	Single mode	4		6	μ A
	Current source calibration range	Double mode	8		12	μ A

36.9 Bandgap and Internal 1.0V Reference Characteristics

Table 36-14. Bandgap and internal 1.0V reference characteristics.

Symbol	Parameter	Condition	Min	Typ	Max	Units
	Startup time	As reference for ADC	$1 \text{ Clk}_{PER} + 2.5\mu\text{s}$			μ s
		As input voltage to ADC and AC		1.5		
	Bandgap voltage			1.1		V
INT1V	Internal 1.00V reference for ADC	$T = 85^{\circ}C$, After calibration	0.99	1	1.01	V
	Variation over voltage and temperature	Calibrated at $T = 85^{\circ}C$		2.25		%

36.10 Brownout Detection Characteristics

Table 36-15. Brownout Detection Characteristics⁽¹⁾.

Symbol	Parameter	Condition	Min	Typ	Max	Units
	BOD level 0 falling V _{CC}	T = 85°C, calibrated	1.5	1.6	1.72	V
	BOD level 1 falling V _{CC}			1.8		
	BOD level 2 falling V _{CC}			2.0		
	BOD level 3 falling V _{CC}			2.2		
	BOD level 4 falling V _{CC}			2.4		
	BOD level 5 falling V _{CC}			2.6		
	BOD level 6 falling V _{CC}			2.8		
	BOD level 7 falling V _{CC}			3.0		
t _{BOD}	Detection time	Continuous mode		0.4		μs
		Sampled mode		1000		
V _{HYST}	Hysteresis			1.6		%

Note: 1. BOD is calibrated at 85°C within BOD level 0 values, and BOD level 0 is the default level.

36.11 External Reset Characteristics

Table 36-16. External reset characteristics.

Symbol	Parameter	Condition	Min	Typ	Max	Units
t _{EXT}	Minimum reset pulse width			90	1000	ns
V _{RST}	Reset threshold voltage	V _{CC} = 2.7 - 3.6V		0.50*V _{CC}		V
		V _{CC} = 1.6 - 2.7V		0.40*V _{CC}		

36.12 Power-on Reset Characteristics

Table 36-17. Power-on reset characteristics.

Symbol	Parameter	Condition	Min	Typ	Max	Units
V _{POT-} ⁽¹⁾	POR threshold voltage falling V _{CC}	V _{CC} falls faster than 1V/ms	0.4	1.0		V
		V _{CC} falls at 1V/ms or slower	0.8	1.3		
V _{POT+}	POR threshold voltage rising V _{CC}			1.3	1.59	V

Note: 1. Both V_{POT-} values are only valid when BOD is disabled. When BOD is enabled the μBOD is enabled, and V_{POT-} = V_{POT+}.

36.13 Flash and EEPROM Memory Characteristics

Table 36-18. Endurance and data retention.

Symbol	Parameter	Condition	Min	Typ	Max	Units
	Flash	Write/Erase cycles	25°C	10K		Cycle
			85°C	10K		
		Data retention	25°C	100		Year
			55°C	25		
	EEPROM	Write/Erase cycles	25°C	100K		Cycle
			85°C	100K		
		Data retention	25°C	100		Year
			55°C	25		

Table 36-19. Programming time.

Symbol	Parameter	Condition	Min	Typ ⁽¹⁾	Max	Units
	Chip Erase	128KB Flash, EEPROM ⁽²⁾		75		ms
		64KB Flash, EEPROM ⁽²⁾		55		
	Flash	Page Erase		4		ms
		Page Write		4		
		Page Write Automatic Page Erase and Write		8		
	EEPROM	Page Erase		4		ms
		Page Write		4		
		Page Write Automatic Page Erase and Write		8		

- Notes:
1. Programming is timed from the 2MHz internal oscillator.
 2. EEPROM is not erased if the EESAVE fuse is programmed.

36.14 Clock and Oscillator Characteristics

36.14.1 Calibrated 32.768kHz Internal Oscillator characteristics

Table 36-20. Calibrated 32.768kHz internal oscillator characteristics.

Symbol	Parameter	Condition	Min	Typ	Max	Units
	Frequency			32.768		kHz
	Factory calibrated accuracy	T = 85°C, V _{CC} = 3.0V	-0.5		0.5	%
	User calibration accuracy		-0.5		0.5	%

36.14.2 Calibrated 2MHz RC Internal Oscillator characteristics

Table 36-21. Calibrated 2MHz internal oscillator characteristics.

Symbol	Parameter	Condition	Min	Typ	Max	Units
	Frequency range	DFLL can tune to this frequency over voltage and temperature	1.8		2.2	MHz
	Factory calibrated frequency			2.0		MHz
	Factory calibration accuracy	T = 85°C, V _{CC} = 3.0V	-1.5		1.5	%
	User calibration accuracy		-0.2		0.2	%
	DFLL calibration stepsize			0.22		%

36.14.3 Calibrated and tunable 32MHz Internal Oscillator characteristics

Table 36-22. Calibrated 32MHz internal oscillator characteristics.

Symbol	Parameter	Condition	Min	Typ	Max	Units
	Frequency range	DFLL can tune to this frequency over voltage and temperature	30		35	MHz
	Factory calibrated frequency			32		MHz
	Factory calibration accuracy	T = 85°C, V _{CC} = 3.0V	-1.5		1.5	%
	User calibration accuracy		-0.2		0.2	%
	DFLL calibration step size			0.23		%

36.14.4 32kHz Internal ULP Oscillator characteristics

Table 36-23. 32kHz internal ULP oscillator characteristics.

Symbol	Parameter	Condition	Min	Typ	Max	Units
	Factory calibrated frequency			32		kHz
	Factory calibration accuracy	T = 85°C, V _{CC} = 3.0V	-12		12	%

36.14.5 Phase Locked Loop (PLL) characteristics

Table 36-24. Internal PLL characteristics.

Symbol	Parameter	Condition	Min	Typ	Max	Units
f _{IN}	Input Frequency	Output frequency must be within f _{OUT}	0.4		64	MHz
f _{OUT}	Output frequency ⁽¹⁾	V _{CC} = 1.60V	20		32	MHz
		V _{CC} = 2.70V	20		128	
	Start-up time			23	100	μs
	re-lock time			20	50	μs

Note: 1. The maximum output frequency vs. supply voltage is linear between 1.8V and 2.7V, and can never be higher than 4 times the maximum CPU frequency.

36.14.6 External Clock Characteristics

Figure 36-3. External Clock Drive Waveform

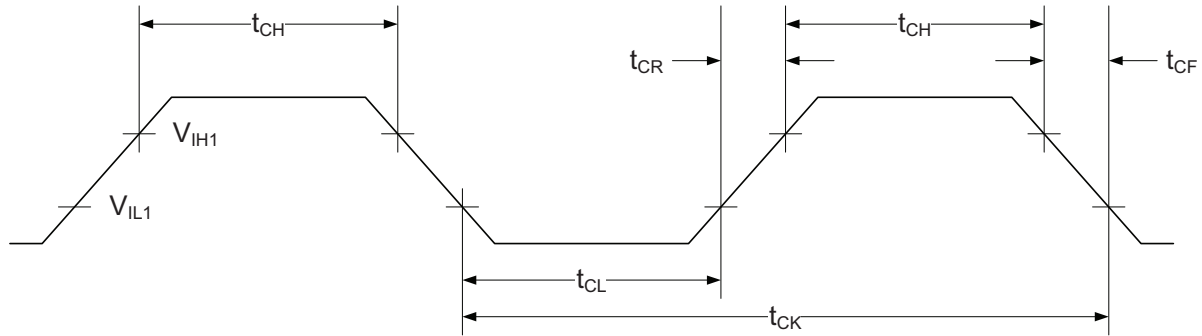

Table 36-25. External clock used as system clock without prescaling.

Symbol	Parameter	Condition	Min	Typ	Max	Units
$1/t_{CK}$	Clock frequency ⁽¹⁾	$V_{CC} = 1.6 - 1.8V$	0		12	MHz
		$V_{CC} = 2.7 - 3.6V$	0		32	
t_{CK}	Clock period	$V_{CC} = 1.6 - 1.8V$	83.3			ns
		$V_{CC} = 2.7 - 3.6V$	31.5			
t_{CH}	Clock high time	$V_{CC} = 1.6 - 1.8V$	30.0			ns
		$V_{CC} = 2.7 - 3.6V$	12.5			
t_{CL}	Clock low time	$V_{CC} = 1.6 - 1.8V$	30.0			ns
		$V_{CC} = 2.7 - 3.6V$	12.5			
t_{CR}	Rise time (for maximum frequency)	$V_{CC} = 1.6 - 1.8V$			10	ns
		$V_{CC} = 2.7 - 3.6V$			3	
t_{CF}	Fall time (for maximum frequency)	$V_{CC} = 1.6 - 1.8V$			10	ns
		$V_{CC} = 2.7 - 3.6V$			3	
Δt_{CK}	Change in period from one clock cycle to the next				10	%

Note: 1. The maximum frequency vs. supply voltage is linear between 1.8V and 2.7V, and the same applies for all other parameters with supply voltage conditions.

Table 36-26. External clock with prescaler⁽¹⁾ for system clock

Symbol	Parameter	Condition	Min	Typ	Max	Units
1/t _{CK}	Clock Frequency ⁽²⁾	V _{CC} = 1.6 - 1.8V	0		90	MHz
		V _{CC} = 2.7 - 3.6V	0		142	
t _{CK}	Clock Period	V _{CC} = 1.6 - 1.8V	11			ns
		V _{CC} = 2.7 - 3.6V	7			
t _{CH}	Clock High Time	V _{CC} = 1.6 - 1.8V	4.5			ns
		V _{CC} = 2.7 - 3.6V	2.4			
t _{CL}	Clock Low Time	V _{CC} = 1.6 - 1.8V	4.5			ns
		V _{CC} = 2.7 - 3.6V	2.4			
t _{CR}	Rise Time (for maximum frequency)	V _{CC} = 1.6 - 1.8V			1.5	ns
		V _{CC} = 2.7 - 3.6V			1.0	
t _{CF}	Fall Time (for maximum frequency)	V _{CC} = 1.6 - 1.8V			1.5	ns
		V _{CC} = 2.7 - 3.6V			1.0	
Δt _{CK}	Change in period from one clock cycle to the next				10	%

- Notes:
1. System Clock Prescalers must be set so that maximum CPU clock frequency for device is not exceeded.
 2. The maximum frequency vs. supply voltage is linear between 1.8V and 2.7V, and the same applies for all other parameters with supply voltage conditions

36.14.7 External 16MHz crystal oscillator and XOSC characteristics

Table 36-27. External 16MHz crystal oscillator and XOSC characteristics.

Symbol	Parameter	Condition	Min.	Typ.	Max.	Units
	Cycle to cycle jitter	XOSCPWR=0, FRQRANGE=0		0		ns
		XOSCPWR=0, FRQRANGE=1, 2, or 3		0		
		XOSCPWR=1		0		
	Long term jitter	XOSCPWR=0, FRQRANGE=0		0		ns
		XOSCPWR=0, FRQRANGE=1, 2, or 3		0		
		XOSCPWR=1		0		
	Frequency error	XOSCPWR=0, FRQRANGE=0		0.03		%
		XOSCPWR=0, FRQRANGE=1		0.03		
		XOSCPWR=0, FRQRANGE=2 or 3		0.03		
		XOSCPWR=1		0.03		
	Duty cycle	XOSCPWR=0, FRQRANGE=0		50		%
		XOSCPWR=0, FRQRANGE=1		50		
		XOSCPWR=0, FRQRANGE=2 or 3		50		
		XOSCPWR=1		50		

Symbol	Parameter	Condition	Min.	Typ.	Max.	Units	
R _Q	Negative impedance ⁽¹⁾	XOSCPWR=0, FRQRANGE=0	0.4MHz resonator, CL=100pF		44k		Ω
			1MHz crystal, CL=20pF		67k		
			2MHz crystal, CL=20pF		67k		
		XOSCPWR=0, FRQRANGE=1, CL=20pF	2MHz crystal		82k		
			8MHz crystal		1500		
			9MHz crystal		1500		
		XOSCPWR=0, FRQRANGE=2, CL=20pF	8MHz crystal		2700		
			9MHz crystal		2700		
			12MHz crystal		1000		
		XOSCPWR=0, FRQRANGE=3, CL=20pF	9MHz crystal		3600		
			12MHz crystal		1300		
			16MHz crystal		590		
		XOSCPWR=1, FRQRANGE=0, CL=20pF	9MHz crystal		390		
			12MHz crystal		50		
			16MHz crystal		10		
		XOSCPWR=1, FRQRANGE=1, CL=20pF	9MHz crystal		1500		
			12MHz crystal		650		
			16MHz crystal		270		
		XOSCPWR=1, FRQRANGE=2, CL=20pF	12MHz crystal		1000		
			16MHz crystal		440		
XOSCPWR=1, FRQRANGE=3, CL=20pF	12MHz crystal		1300				
	16MHz crystal		590				
Start-up time		XOSCPWR=0, FRQRANGE=0	0.4MHz resonator, CL=100pF		1.0		ms
		XOSCPWR=0, FRQRANGE=1	2MHz crystal, CL=20pF		2.6		
		XOSCPWR=0, FRQRANGE=2	8MHz crystal, CL=20pF		0.8		
		XOSCPWR=0, FRQRANGE=3	12MHz crystal, CL=20pF		1.0		
		XOSCPWR=1, FRQRANGE=3	16MHz crystal, CL=20pF		1.4		
ESR		SF = Safety factor			min(RQ)/SF	kΩ	

Symbol	Parameter	Condition	Min.	Typ.	Max.	Units
C_{XTAL1}	Parasitic capacitance			5.9		pF
C_{XTAL2}	Parasitic capacitance			8.3		
C_{LOAD}	Parasitic capacitance load			3.5		

Note: 1. Numbers for negative impedance are not tested but guaranteed from design and characterization.

36.14.8 External 32.768kHz crystal oscillator and TOSC characteristics

Table 36-28. External 32.768kHz crystal oscillator and TOSC characteristics.

Symbol	Parameter	Condition	Min	Typ	Max	Units
ESR/R1	Recommended crystal equivalent series resistance (ESR)	Crystal load capacitance 6.5pF			60	k Ω
		Crystal load capacitance 9.0pF			35	
		Crystal load capacitance 12.0pF			28	
C_{IN_TOSC}	Input capacitance between TOSC pins	Normal mode		3.5		pF
		Low power mode		3.5		
	Recommended Safety factor	capacitance load matched to crystal specification	3			
	Long term Jitter (SIT)			0		%

Note: 1. See Figure 36-4 on page 87 for definition

Figure 36-4. TOSC input capacitance

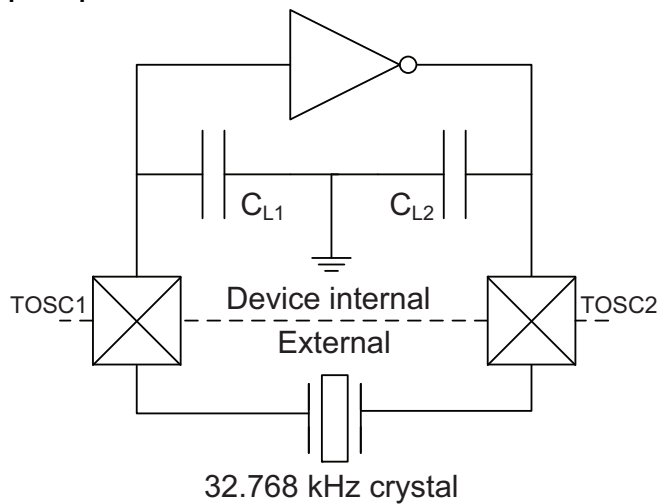

The input capacitance between the TOSC pins is $C_{L1} + C_{L2}$ in series as seen from the crystal when oscillating without external capacitors.

36.15 SPI characteristics

Figure 36-5. SPI interface requirements in master mode

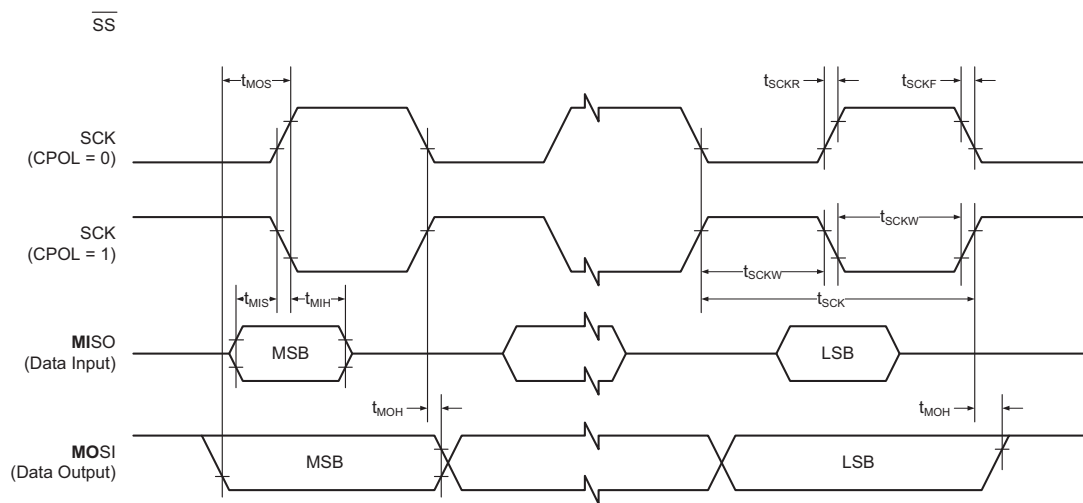

Figure 36-6. SPI timing requirements in slave mode

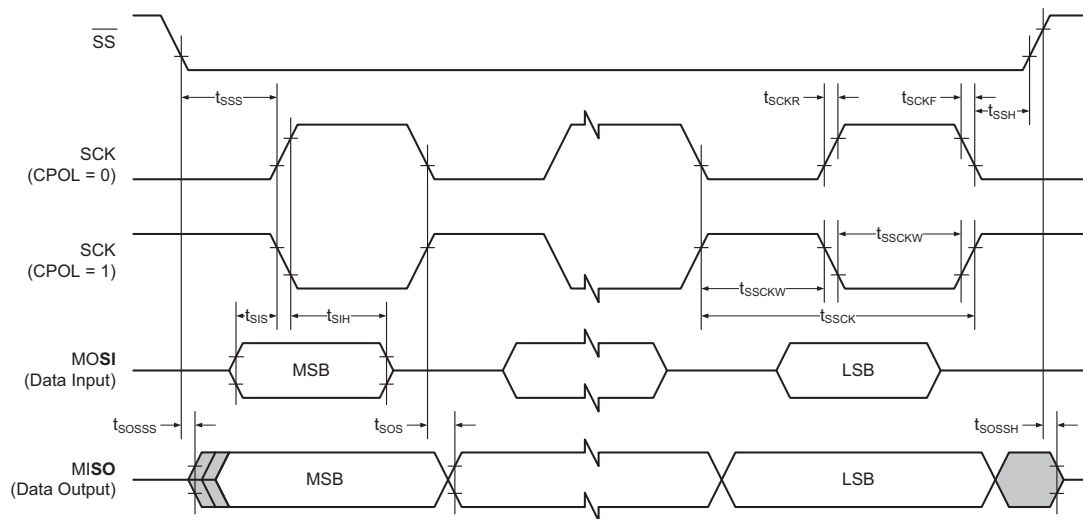

Table 36-29. SPI Timing characteristics and requirements.

Symbol	Parameter	Condition	Min	Typ	Max	Units
t_{SCK}	SCK Period	Master		(See Table 21-4 in XMEGA B Manual)		ns
t_{SCKW}	SCK high/low width	Master		$0.5 \cdot SCK$		
t_{SCKR}	SCK Rise time	Master		2.7		
t_{SCKF}	SCK Fall time	Master		2.7		
t_{MIS}	MISO setup to SCK	Master		11		
t_{MIH}	MISO hold after SCK	Master		0		
t_{MOS}	MOSI setup SCK	Master		$0.5 \cdot SCK$		
t_{MOH}	MOSI hold after SCK	Master		1		
t_{SSCK}	Slave SCK Period	Slave	$4 \cdot t_{Clk_{PER}}$			
t_{SSCKW}	SCK high/low width	Slave	$2 \cdot t_{Clk_{PER}}$			
t_{SSCKR}	SCK Rise time	Slave			1600	
t_{SSCKF}	SCK Fall time	Slave			1600	
t_{SIS}	MOSI setup to SCK	Slave	3			
t_{SIH}	MOSI hold after SCK	Slave	$t_{Clk_{PER}}$			
t_{SSS}	\overline{SS} setup to SCK	Slave	21			
t_{SSH}	\overline{SS} hold after SCK	Slave	20			
t_{SOS}	MISO setup SCK	Slave		8		
t_{SOH}	MISO hold after SCK	Slave		13		
t_{SOSS}	MISO setup after \overline{SS} low	Slave		11		
t_{SOSh}	MISO hold after \overline{SS} high	Slave		8		

36.16 Two-Wire Interface Characteristics

Table 36-30 describes the requirements for devices connected to the Two Wire Serial Bus. The XMEGA Two-Wire Interface meets or exceeds these requirements under the noted conditions. Timing symbols refer to Figure 36-7.

Figure 36-7. Two-Wire Interface Bus Timing

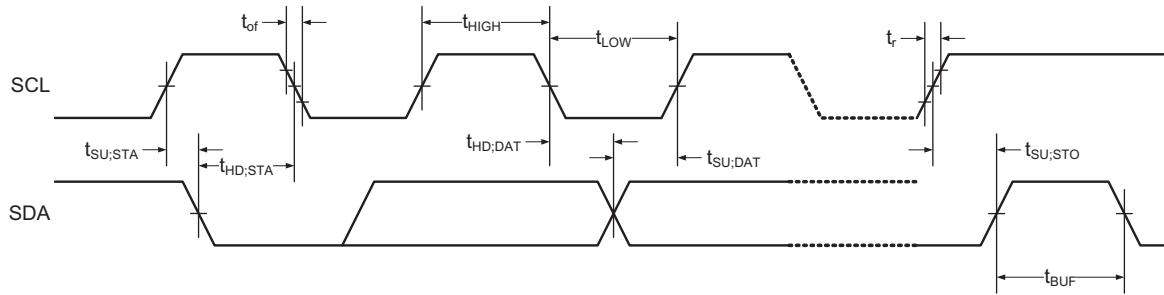

Table 36-30. Two wire serial bus characteristics.

Symbol	Parameter	Condition	Min	Typ	Max	Units
V_{IH}	Input High Voltage		$0.7 \cdot V_{CC}$		$V_{CC} + 0.5$	V
V_{IL}	Input Low Voltage		-0.5		$0.3 \cdot V_{CC}$	V
V_{hys}	Hysteresis of Schmitt Trigger Inputs		$0.05 V_{CC}^{(1)}$		0	V
V_{OL}	Output Low Voltage	3mA, sink current	0		0.4	V
t_r	Rise Time for both SDA and SCL		$20 + 0.1 C_b^{(1)(2)}$		300	ns
t_{of}	Output Fall Time from V_{IHmin} to V_{ILmax}	$10pF < C_b < 400pF^{(2)}$	$20 + 0.1 C_b^{(1)(2)}$		250	ns
t_{SP}	Spikes Suppressed by Input Filter		0		50	ns
I_i	Input Current for each I/O Pin	$0.1 V_{CC} < V_i < 0.9 V_{CC}$	-10		10	μA
C_i	Capacitance for each I/O Pin				10	pF
f_{SCL}	SCL Clock Frequency	$f_{PER}^{(3)} > \max(10f_{SCL}, 250kHz)$	0		400	kHz
R_P	Value of Pull-up resistor	$f_{SCL} \leq 100kHz$	$\frac{V_{CC} - 0.4V}{3mA}$	$\frac{100ns}{C_b}$	$\frac{300ns}{C_b}$	Ω
		$f_{SCL} > 100kHz$				
$t_{HD:STA}$	Hold Time (repeated) START condition	$f_{SCL} \leq 100kHz$	4.0			μs
		$f_{SCL} > 100kHz$	0.6			
t_{LOW}	Low Period of SCL Clock	$f_{SCL} \leq 100kHz$	4.7			μs
		$f_{SCL} > 100kHz$	1.3			
t_{HIGH}	High Period of SCL Clock	$f_{SCL} \leq 100kHz$	4.0			μs
		$f_{SCL} > 100kHz$	0.6			
$t_{SU:STA}$	Set-up time for a repeated START condition	$f_{SCL} \leq 100kHz$	4.7			μs
		$f_{SCL} > 100kHz$	0.6			
$t_{HD:DAT}$	Data hold time	$f_{SCL} \leq 100kHz$	0		3.5	μs
		$f_{SCL} > 100kHz$	0		0.9	

Symbol	Parameter	Condition	Min	Typ	Max	Units
$t_{\text{SU;DAT}}$	Data setup time	$f_{\text{SCL}} \leq 100\text{kHz}$	250			μs
		$f_{\text{SCL}} > 100\text{kHz}$	100			
$t_{\text{SU;STO}}$	Setup time for STOP condition	$f_{\text{SCL}} \leq 100\text{kHz}$	4.0			μs
		$f_{\text{SCL}} > 100\text{kHz}$	0.6			
t_{BUF}	Bus free time between a STOP and START condition	$f_{\text{SCL}} \leq 100\text{kHz}$	4.7			μs
		$f_{\text{SCL}} > 100\text{kHz}$	1.3			

- Notes:
1. Required only for $f_{\text{SCL}} > 100\text{kHz}$
 2. C_b = Capacitance of one bus line in pF
 3. f_{PER} = Peripheral clock frequency

37. Typical Characteristics

37.1 Current consumption

37.1.1 Active mode supply current

Figure 37-1. Active supply current vs. frequency.

$f_{SYS} = 0$ - 1MHz external clock, $T = 25^{\circ}\text{C}$.

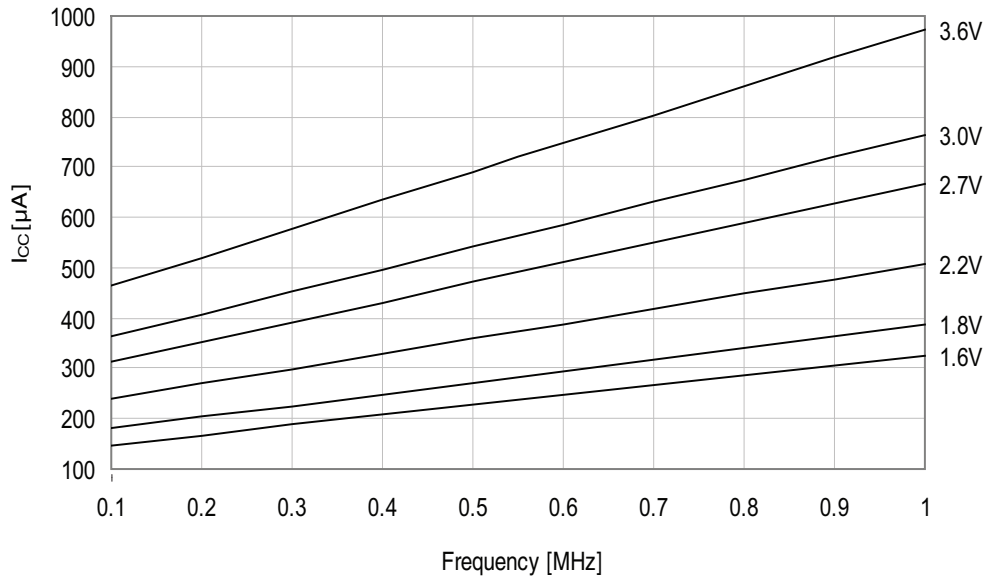

Figure 37-2. Active supply current vs. frequency.

$f_{SYS} = 1$ - 32MHz external clock, $T = 25^{\circ}\text{C}$.

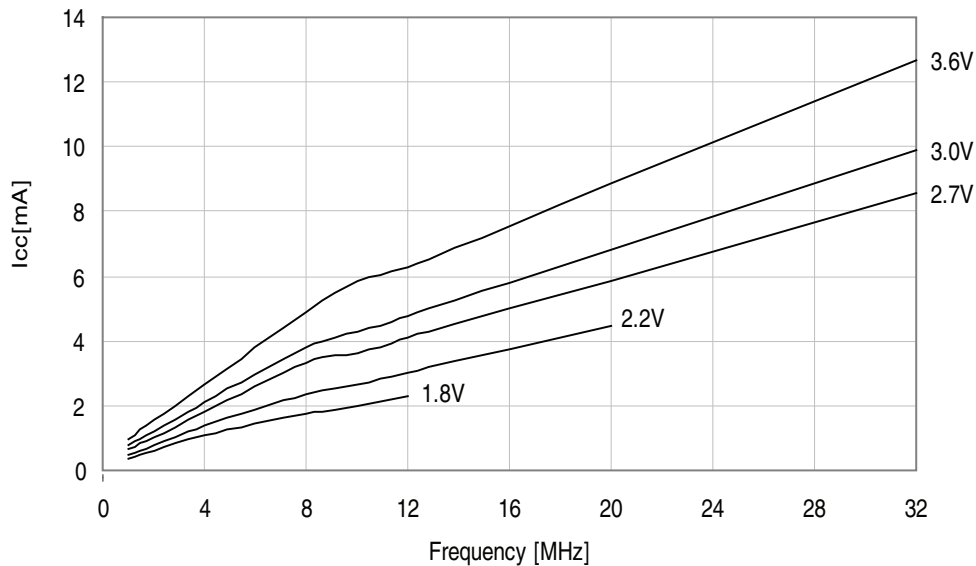

Figure 37-3. Active mode supply current vs. V_{CC} .

$f_{SYS} = 2MHz$ internal oscillator.

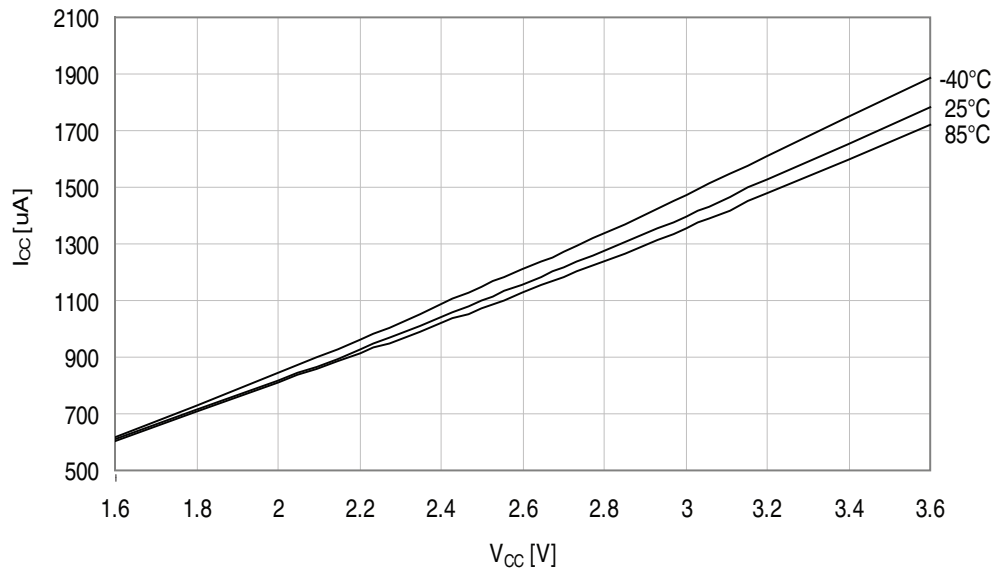
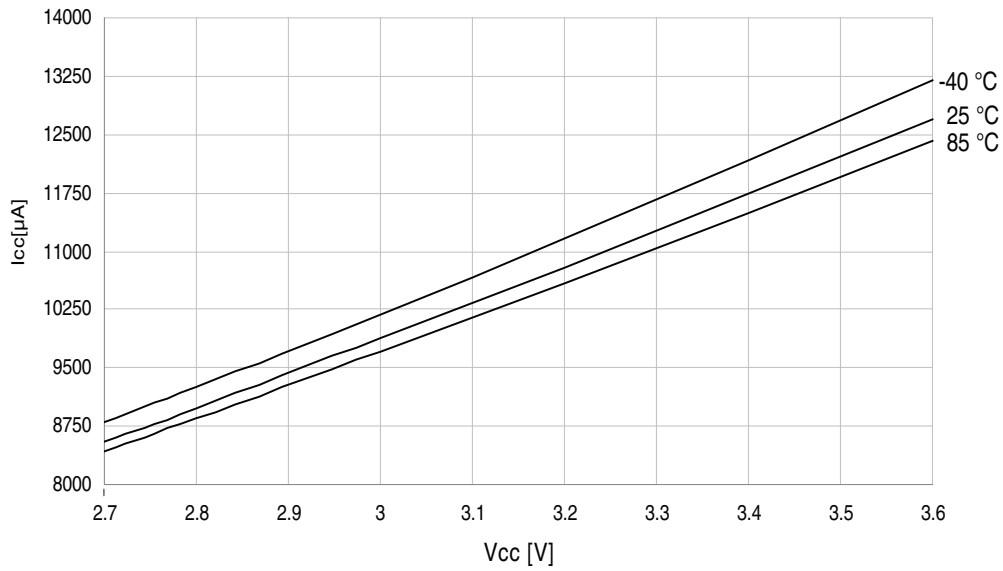

Figure 37-4. Active mode supply current vs. V_{CC} .

$f_{SYS} = 32MHz$ internal oscillator.



37.1.2 Idle mode supply current

Figure 37-5. Idle mode supply current vs. frequency.

$f_{SYS} = 0$ - 1MHz external clock, $T = 25^{\circ}\text{C}$.

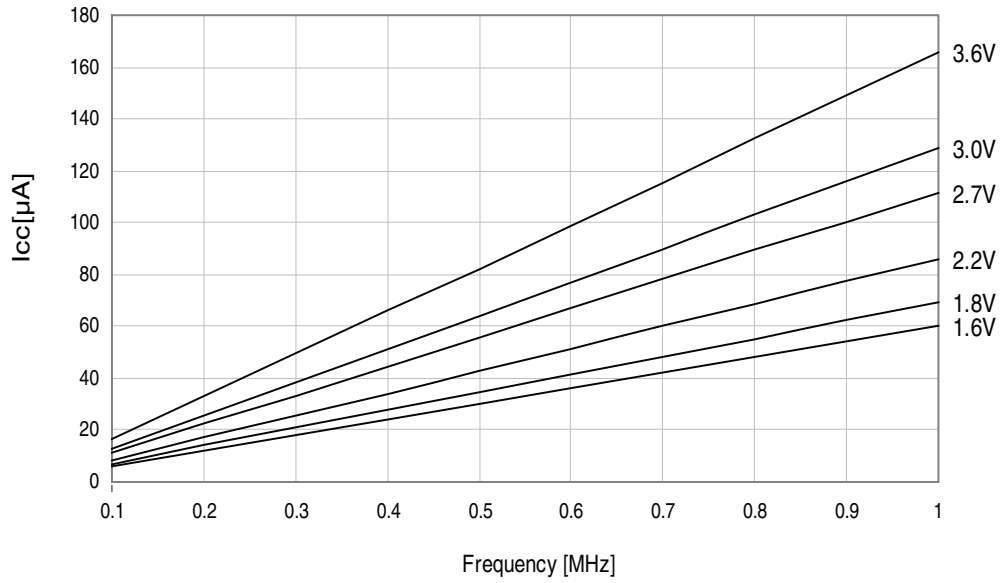

Figure 37-6. Idle mode supply current vs. frequency.

$f_{SYS} = 1$ - 32MHz external clock, $T = 25^{\circ}\text{C}$.

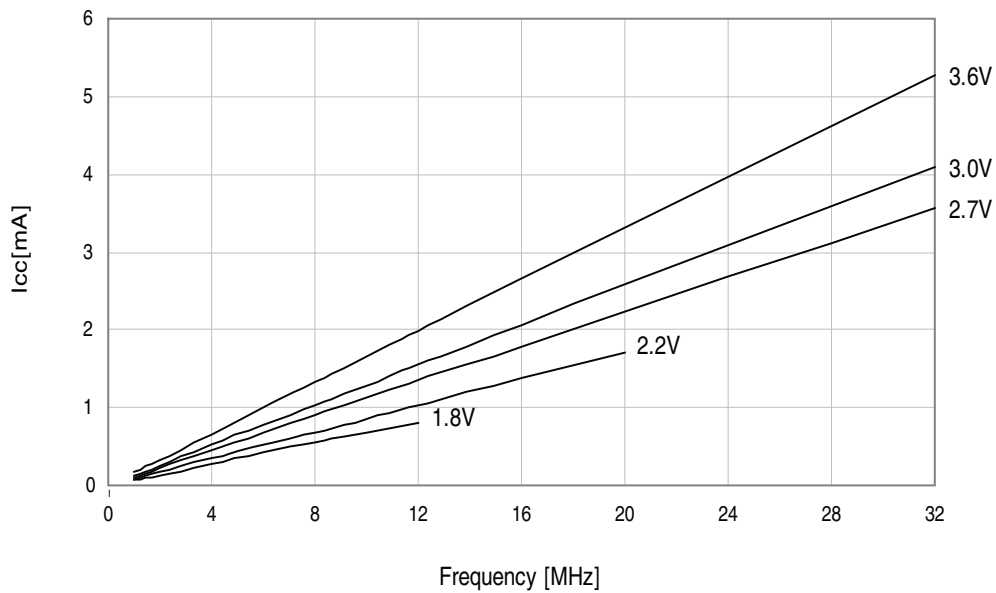

Figure 37-7. Idle mode supply current vs. V_{CC} .

$f_{SYS} = 32.768\text{kHz}$ internal oscillator.

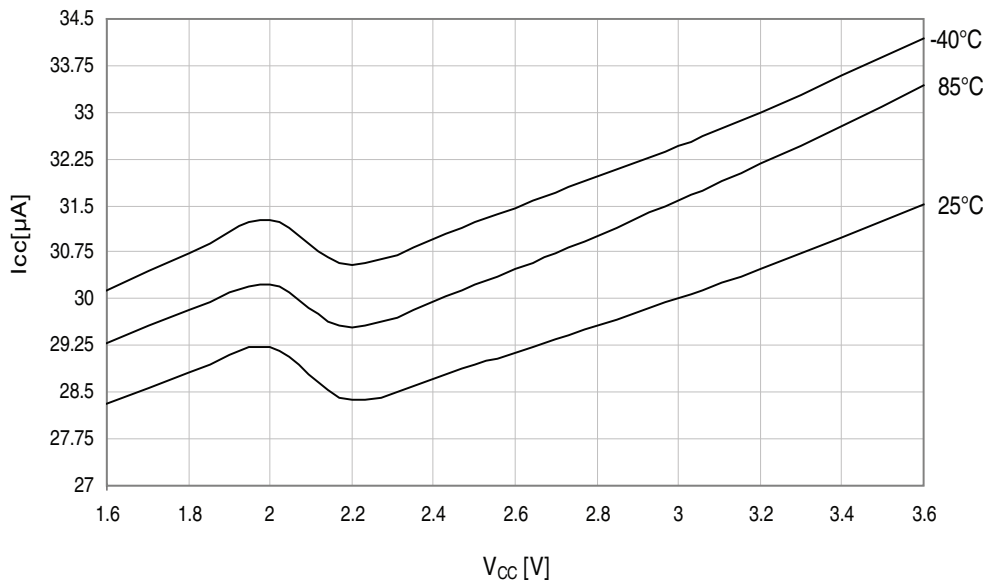

Figure 37-8. Idle mode supply current vs. V_{CC} .

$f_{SYS} = 2\text{MHz}$ internal oscillator.

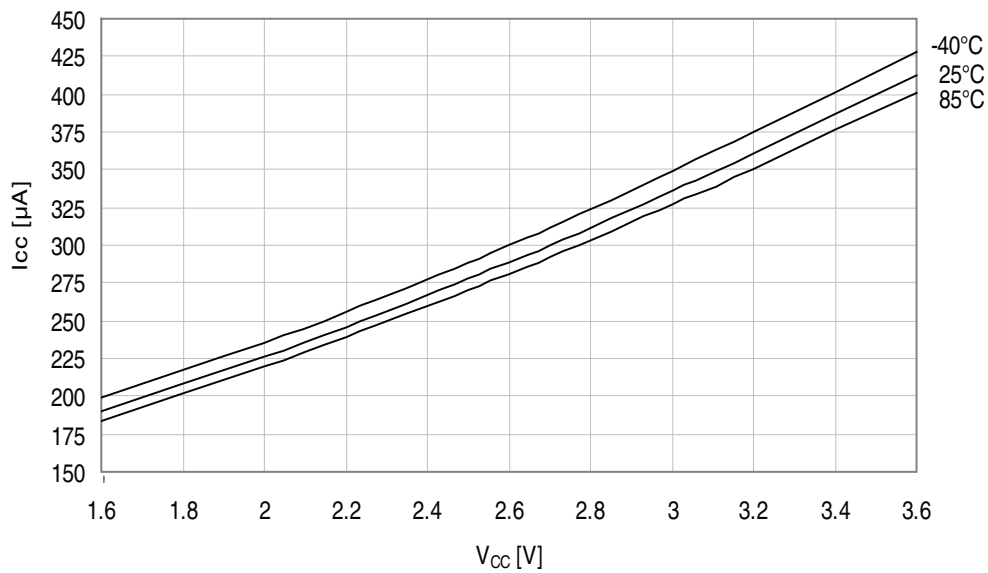
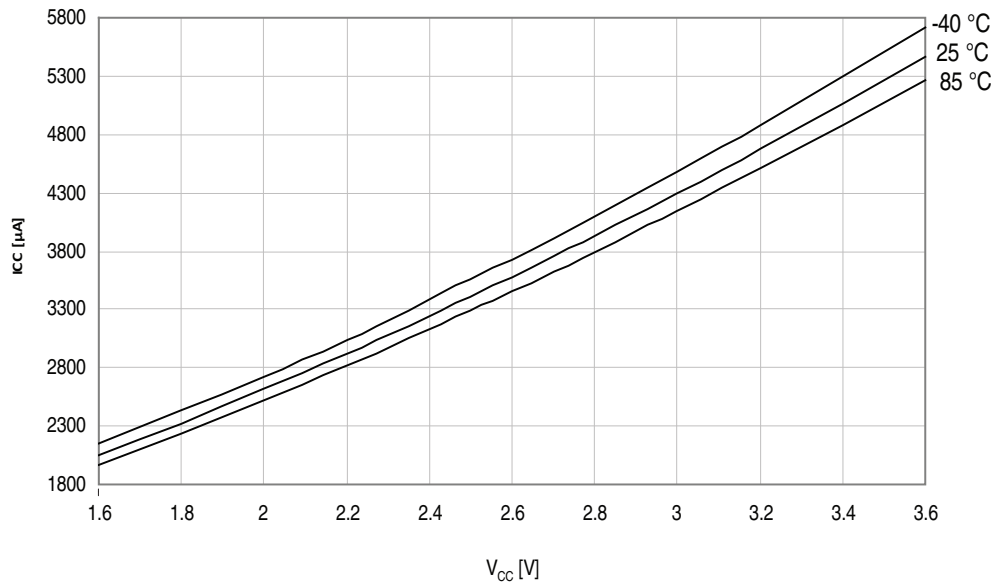

Figure 37-9. Idle mode current vs. V_{CC} .
 $f_{SYS} = 32MHz$ internal oscillator.



37.1.3 Power-down mode supply current

Figure 37-10. Power-down mode supply current vs. Temperature.
 All functions disabled.

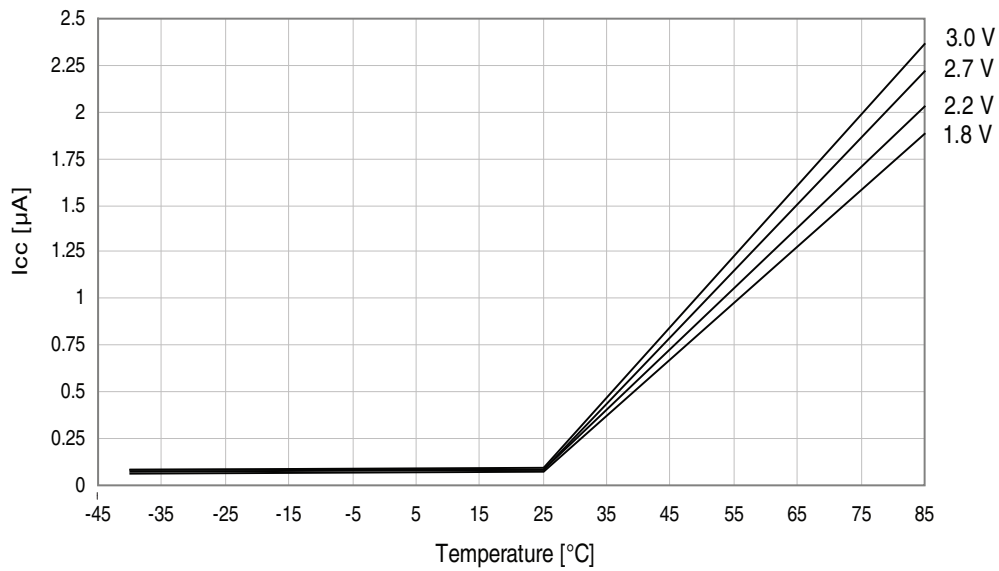
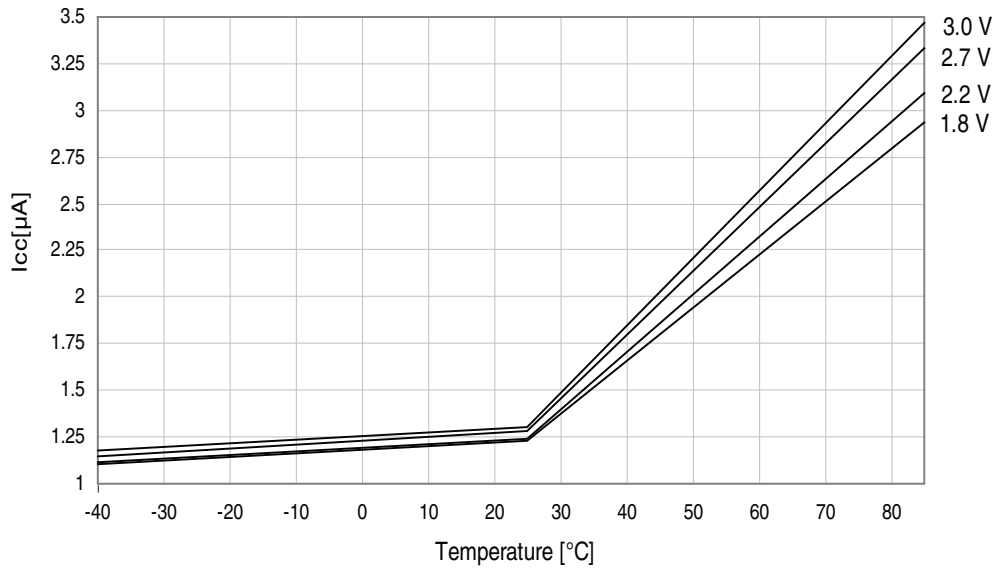

Figure 37-11. Power-down mode supply current vs. Temperature.
Watchdog and sampled BOD enabled.



37.2 I/O Pin Characteristics

37.2.1 Pull-up

Figure 37-12. I/O pin pull-up resistor current vs. input voltage.
 $V_{CC} = 1.8V$.

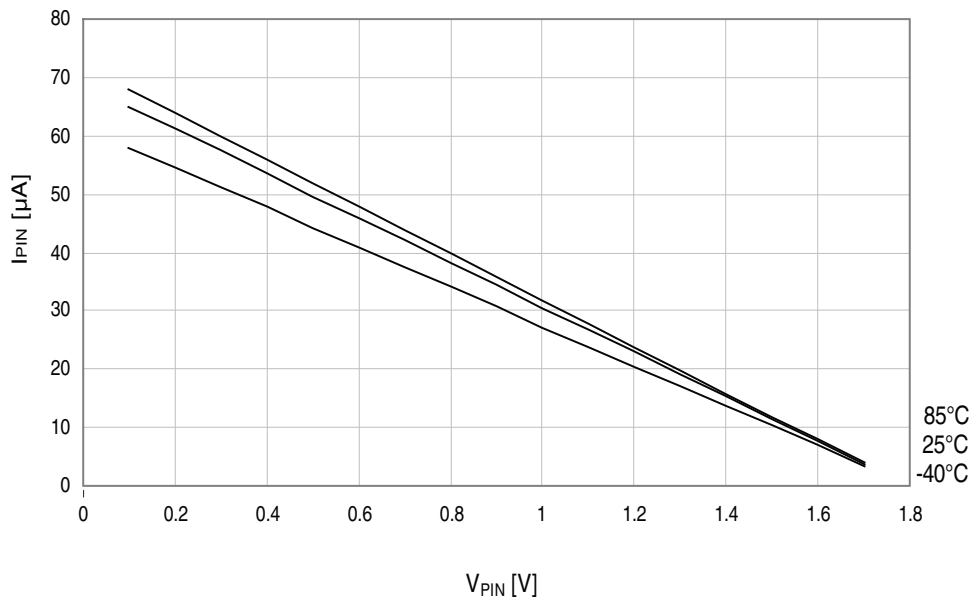

Figure 37-13. I/O pin pull-up resistor current vs. input voltage.

$V_{CC} = 3.0V$.

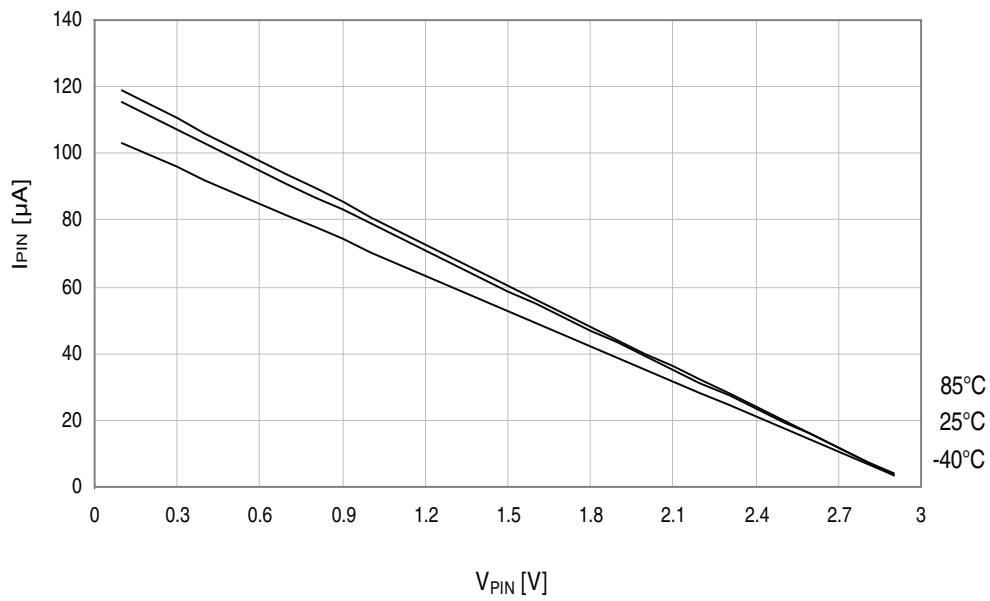
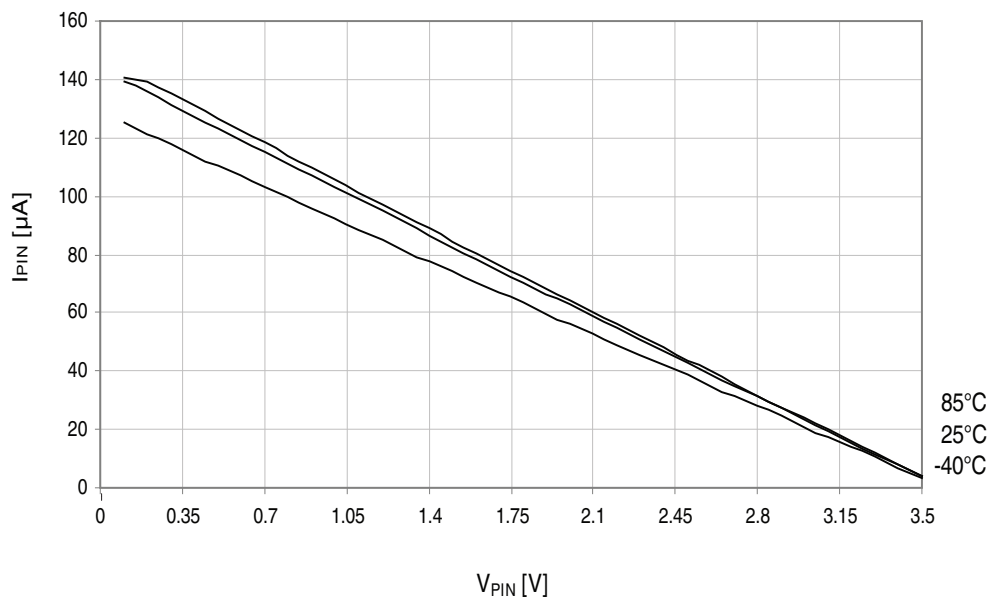

Figure 37-14. I/O pin pull-up resistor current vs. pin voltage.

$V_{CC} = 3.3V$.



37.2.2 Output Voltage vs. Sink/Source Current

Figure 37-15. I/O pin output voltage vs. source current.

$V_{CC} = 1.8V$.

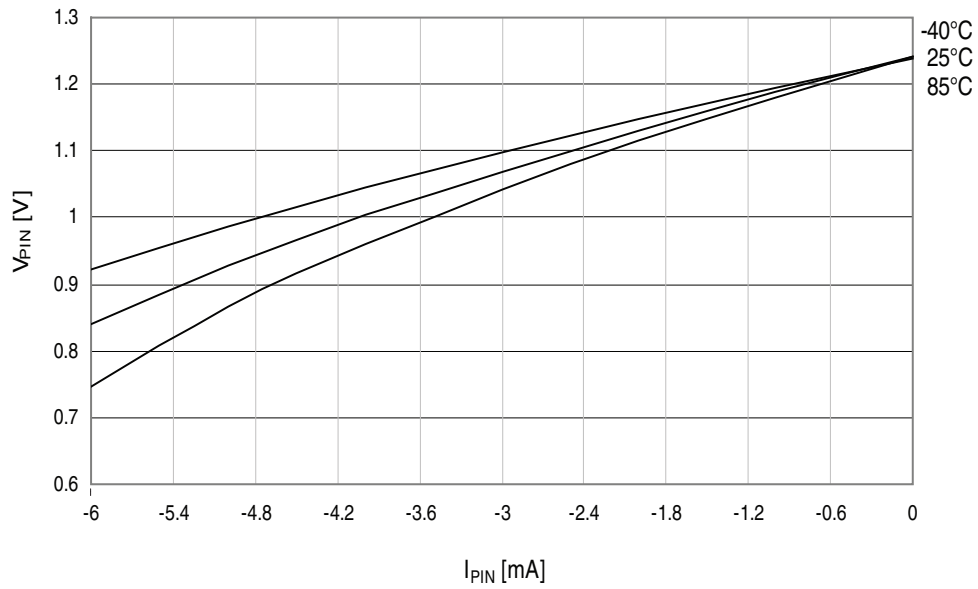

Figure 37-16. I/O pin output voltage vs. source current.

$V_{CC} = 3.0V$.

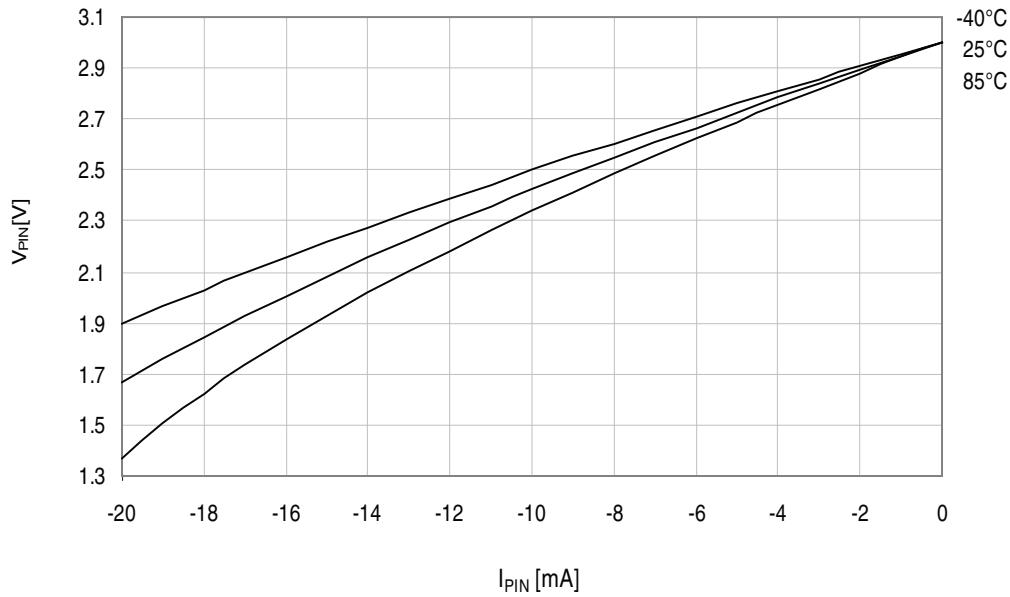

Figure 37-17. I/O pin output voltage vs. source current.

$V_{CC} = 3.3V$.

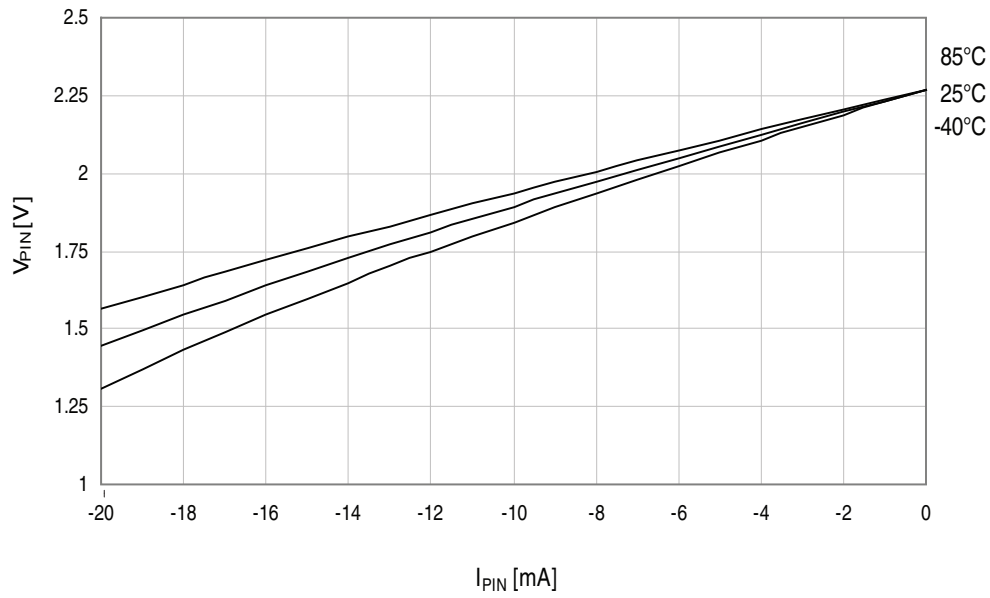

Figure 37-18. I/O pin output voltage vs. sink current.

$V_{CC} = 1.8V$.

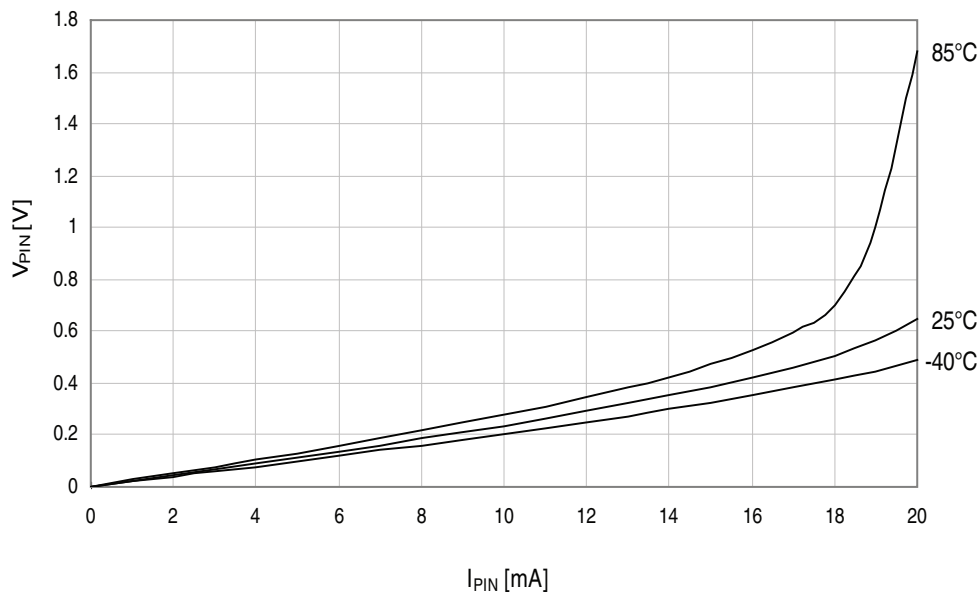

Figure 37-19. I/O pin output voltage vs. sink current.

$V_{CC} = 3.0V$.

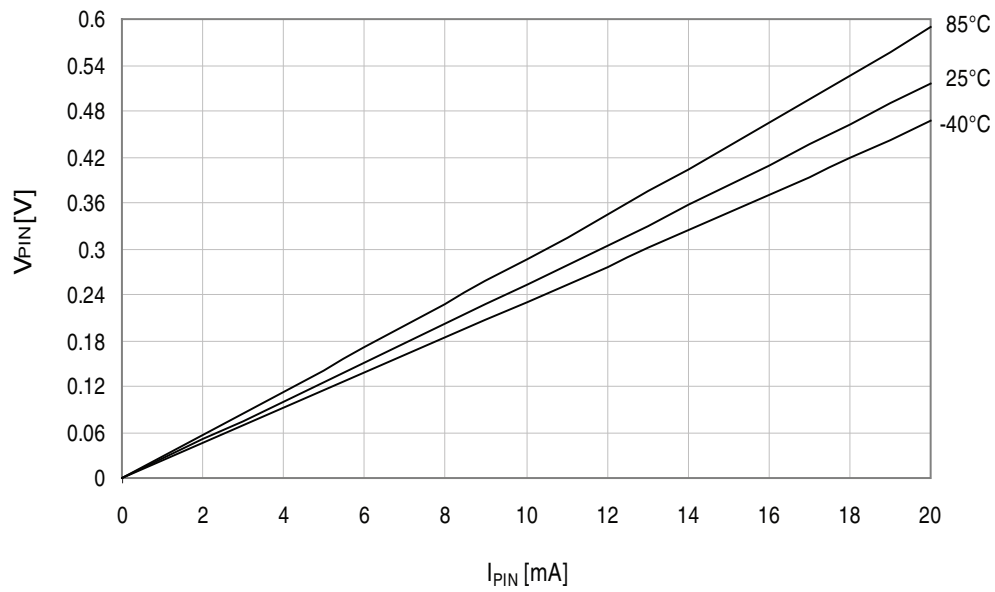
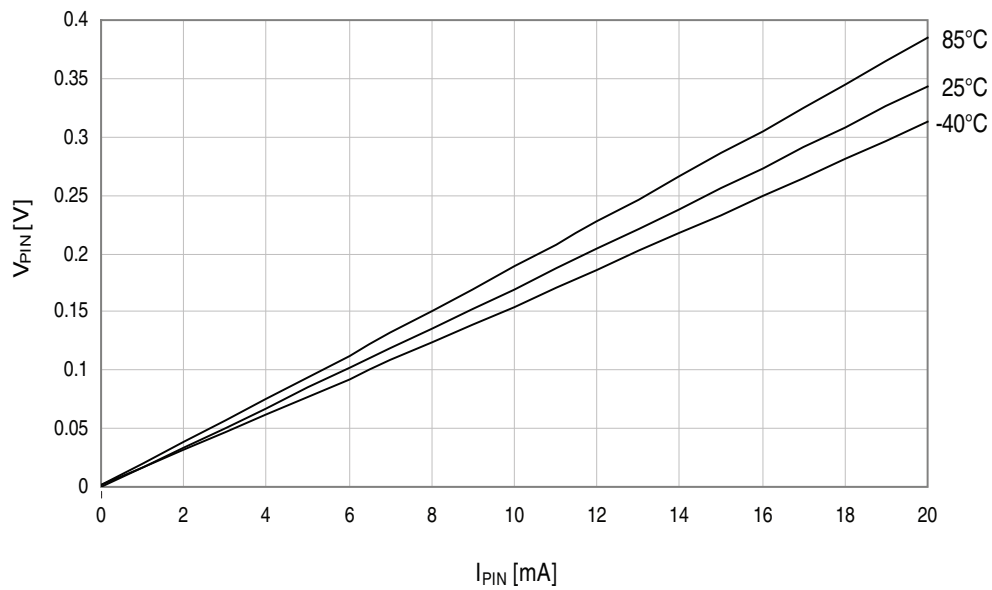

Figure 37-20. I/O pin output voltage vs. sink current.

$V_{CC} = 3.3V$.



37.2.3 Thresholds and Hysteresis

Figure 37-21. I/O pin input threshold voltage vs. V_{CC} .
 V_{IH} I/O pin read as "1".

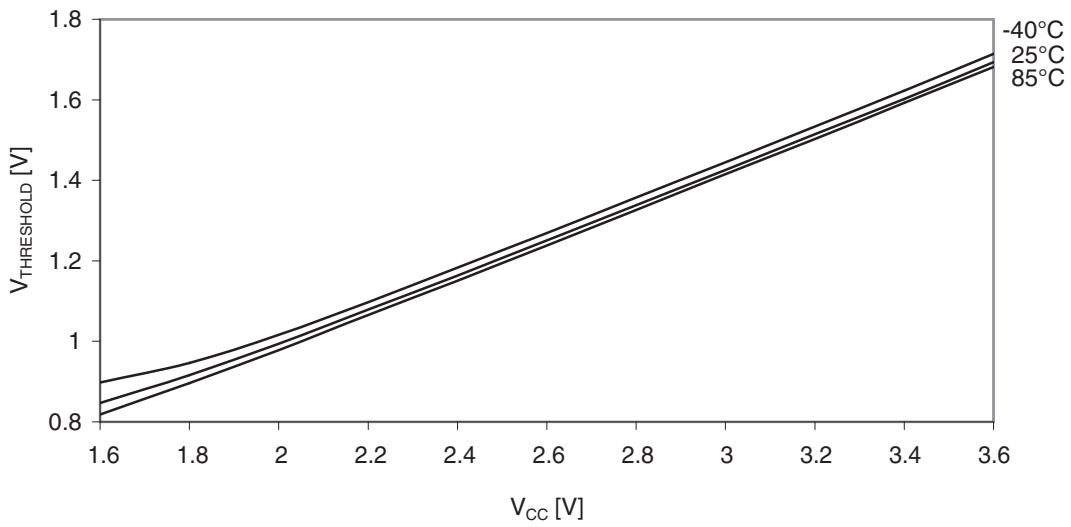

Figure 37-22. I/O pin input threshold voltage vs. V_{CC} .
 V_{IL} I/O pin read as "0".

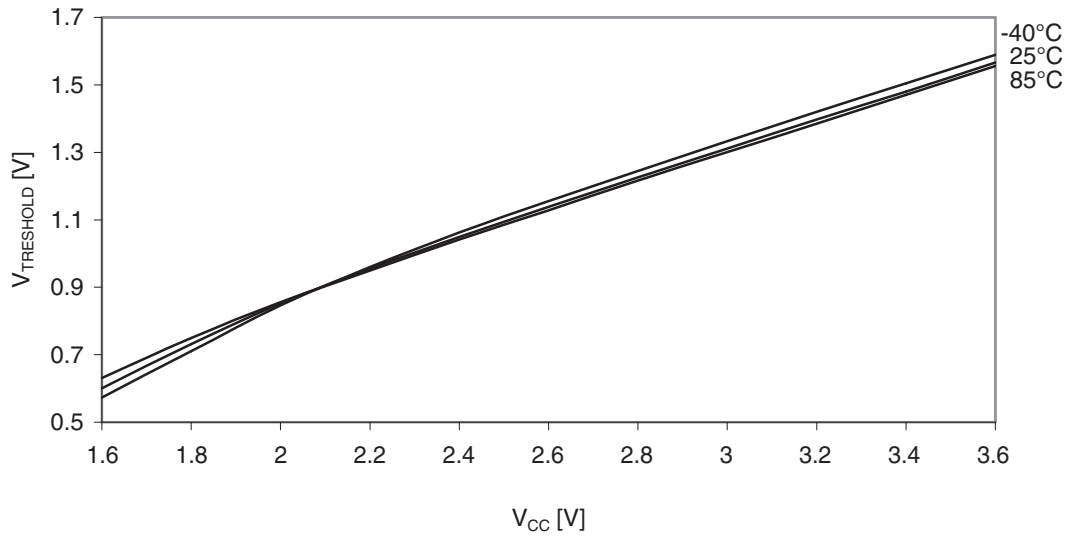
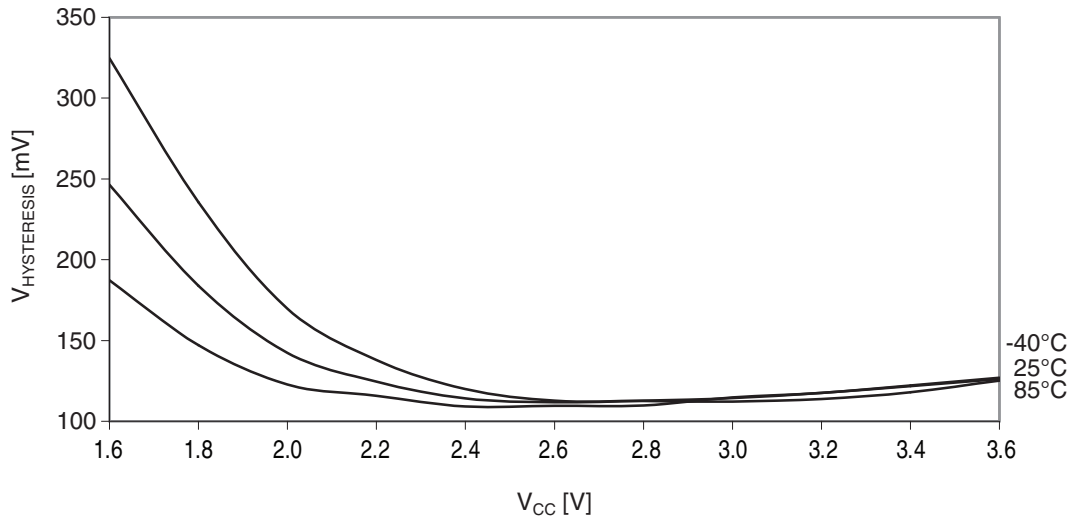

Figure 37-23. I/O pin input hysteresis vs. V_{CC} .



37.3 ADC Characteristics

Figure 37-24. ADC INL vs. V_{REF} .
Differential signed mode, $V_{CC} = 3.6V$, external reference.

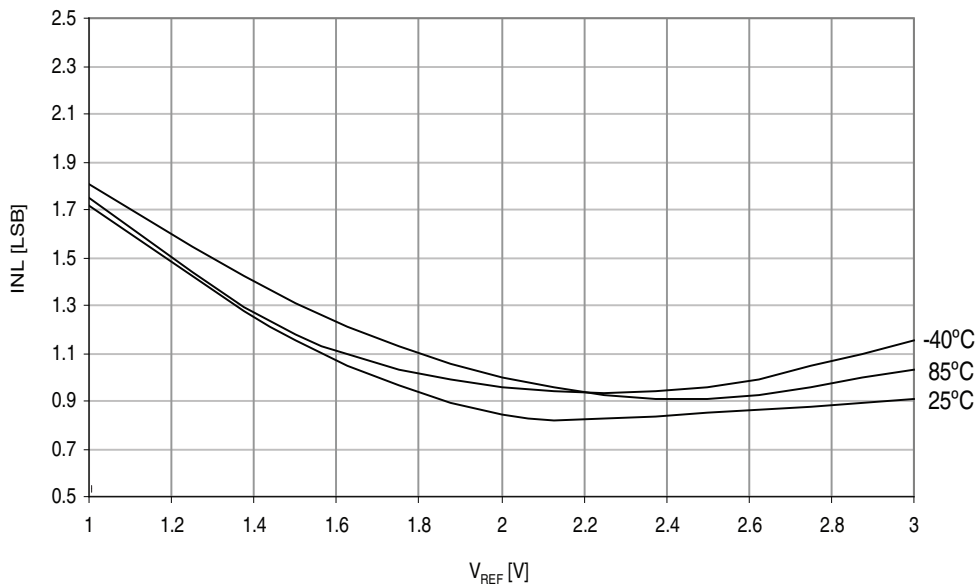

Figure 37-25. ADC INL vs. V_{REF} .
SE Unsigned mode, $V_{CC} = 3.6V$, external reference.

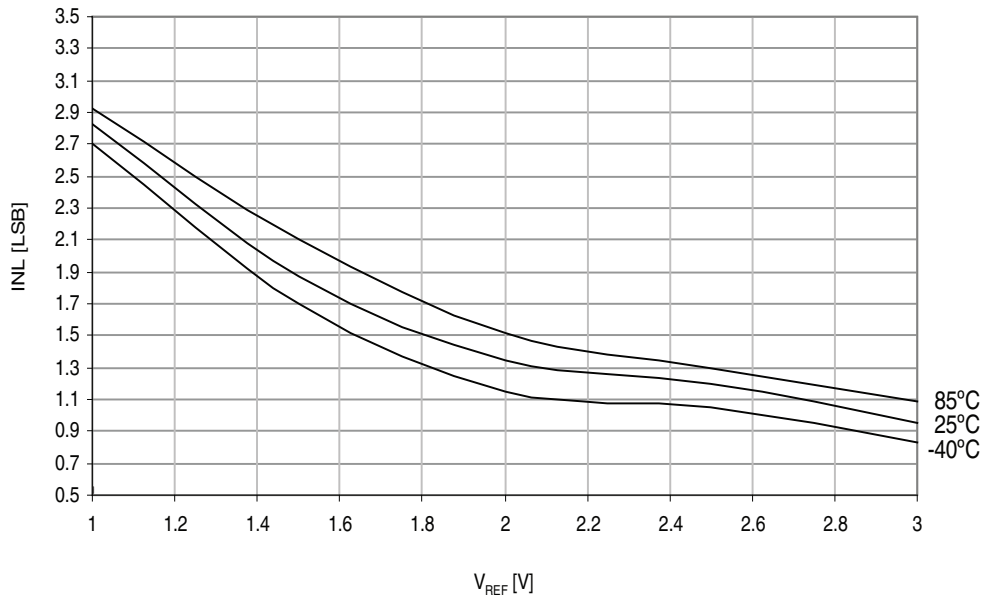

Figure 37-26. ADC DNL vs. V_{REF} .
Differential signed mode, $V_{CC} = 3.6V$, external reference.

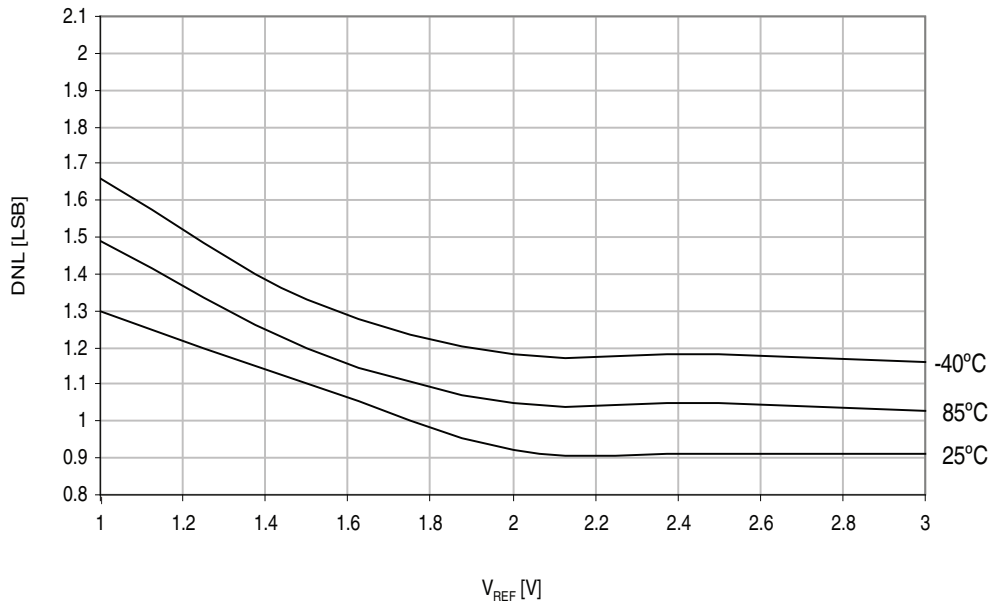

Figure 37-27. ADC DNL vs. V_{REF} .
SE Unsigned mode, $V_{CC} = 3.6V$, external reference.

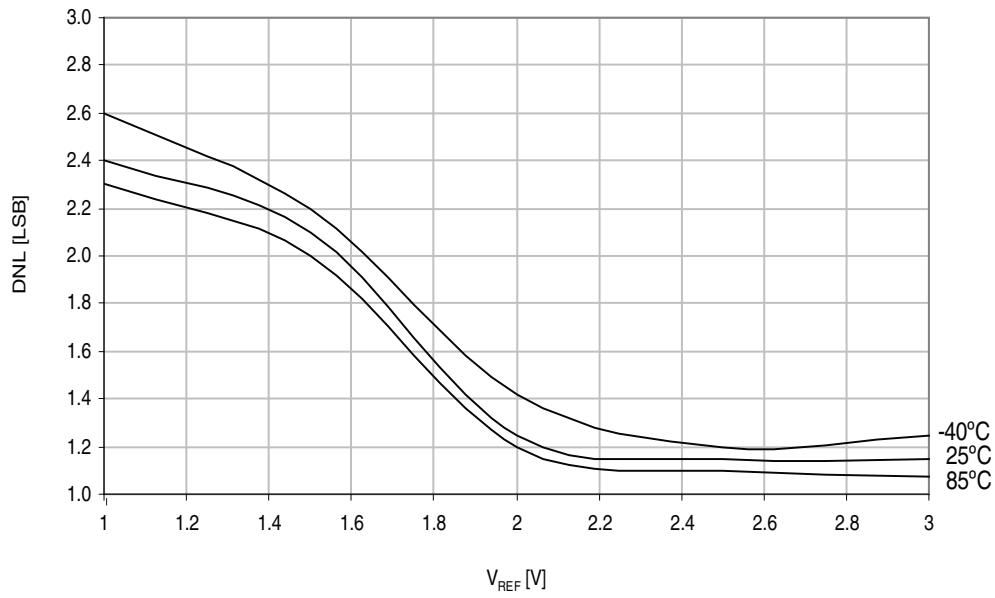

Figure 37-28. ADC Offset vs. V_{CC} .
SE Unsigned mode, $V_{REF} = 1.0V$, external reference.

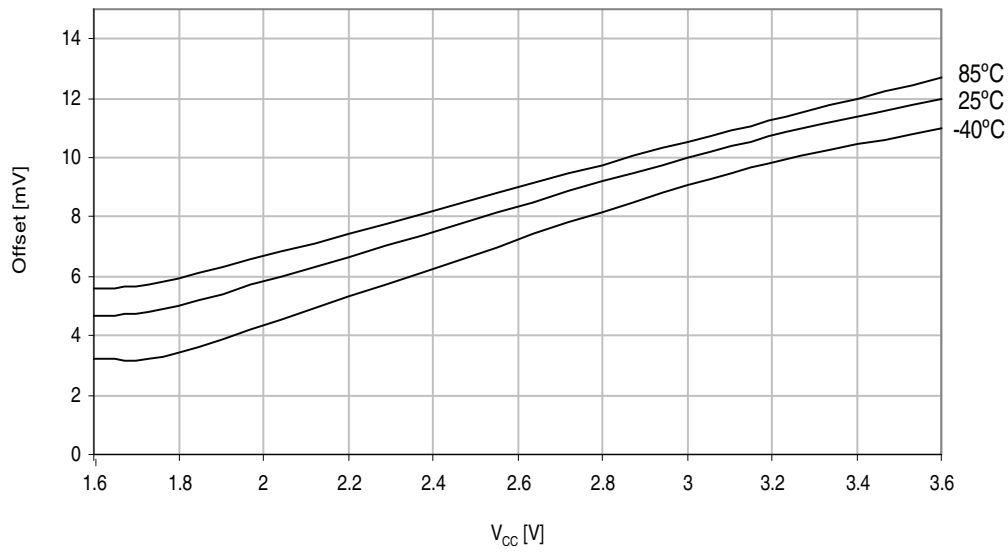

Figure 37-29. ADC Offset vs. V_{REF} .
SE Unsigned mode, $V_{CC} = 3.6V$, external reference.

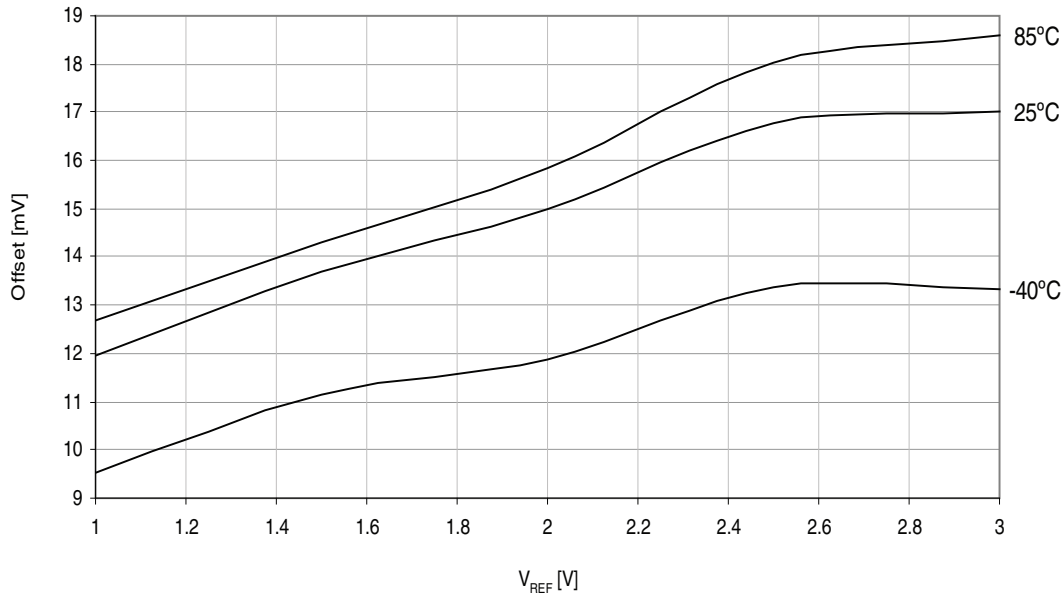

Figure 37-30. ADC Offset vs. V_{REF} .
Differential signed mode, $V_{CC} = 3.6V$, external reference.

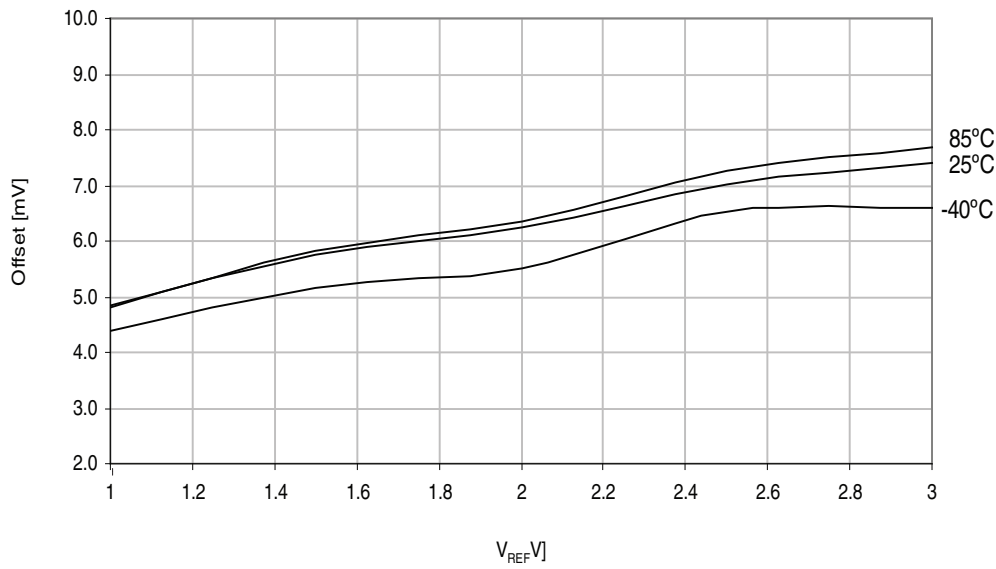

Figure 37-31. ADC Offset vs. V_{CC} .
Differential signed mode, $V_{REF} = 1.0V$, external reference.

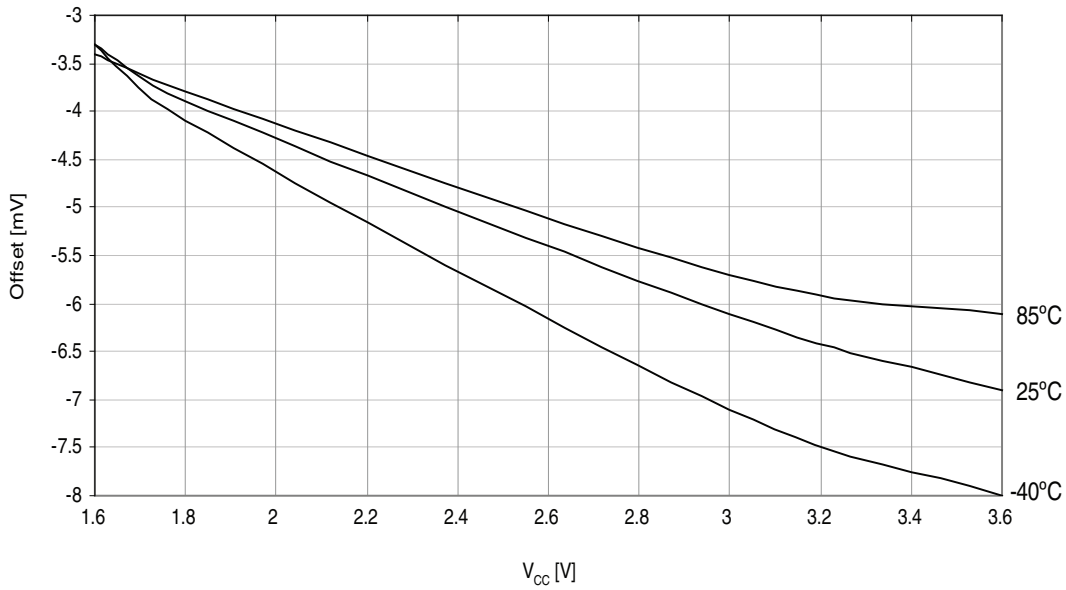

Figure 37-32. ADC Gain Error vs. V_{REF} .
Differential signed mode, external reference.

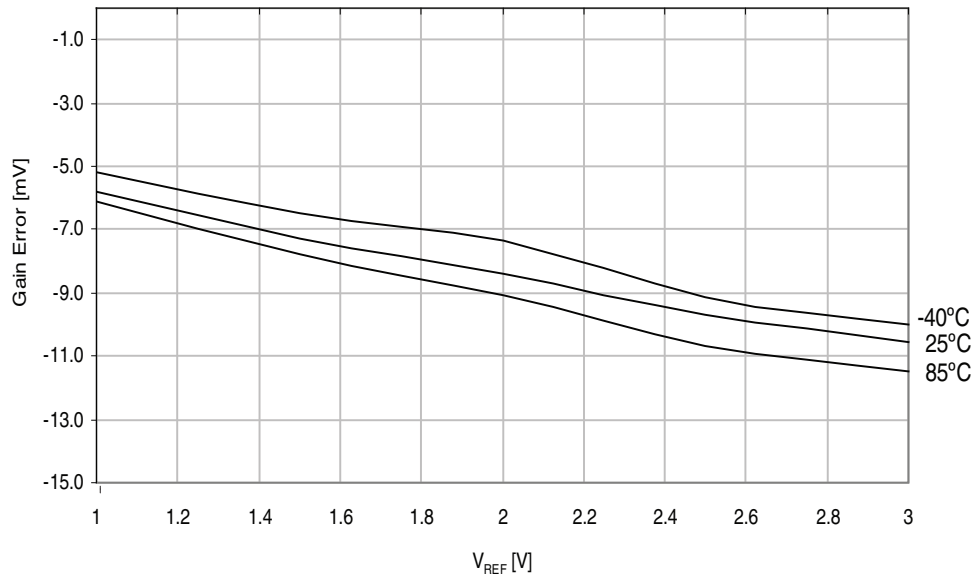

Figure 37-33. ADC Gain Error vs. V_{REF}
SE Unsigned mode, external reference.

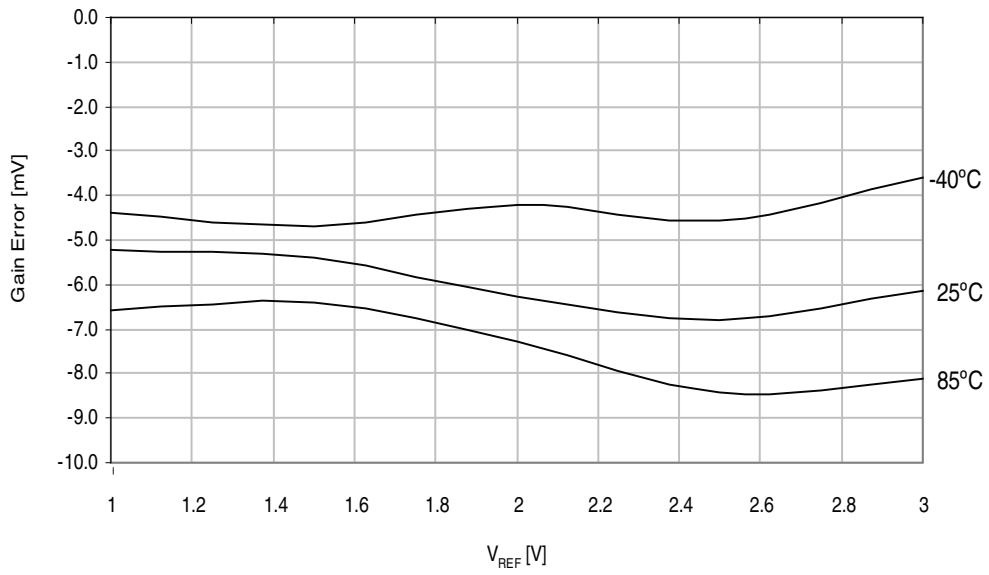

Figure 37-34. ADC Gain Error vs. V_{CC}
Differential signed mode, external reference.

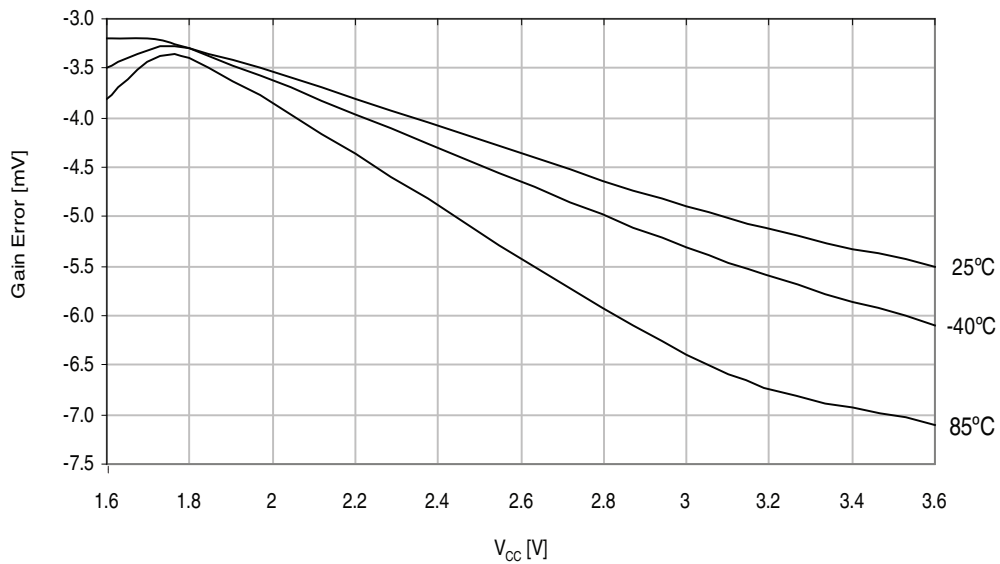

Figure 37-35. ADC Gain Error vs. V_{CC} .
SE Unsigned mode, external reference.

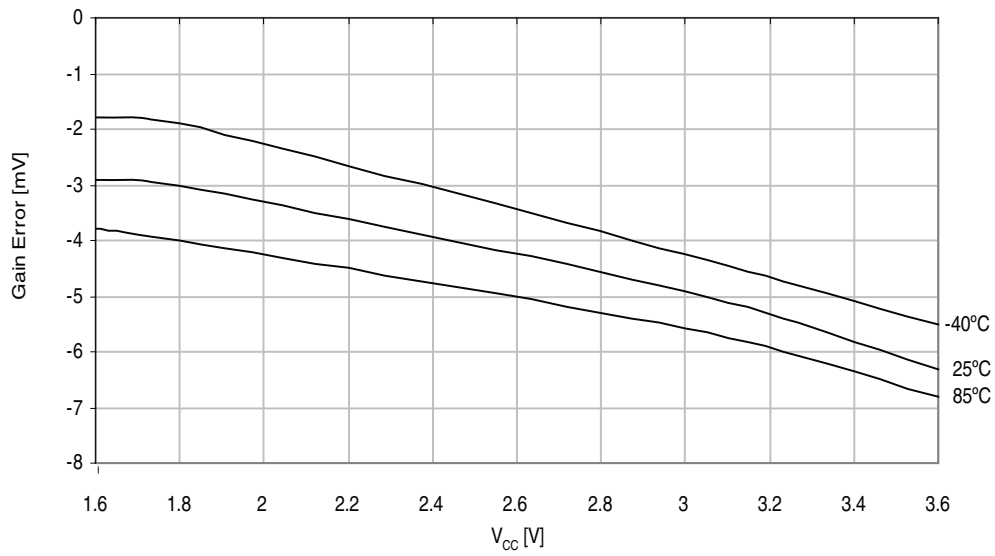

Figure 37-36. ADC Gain Error vs. Temperature.
Differential signed mode, external reference.

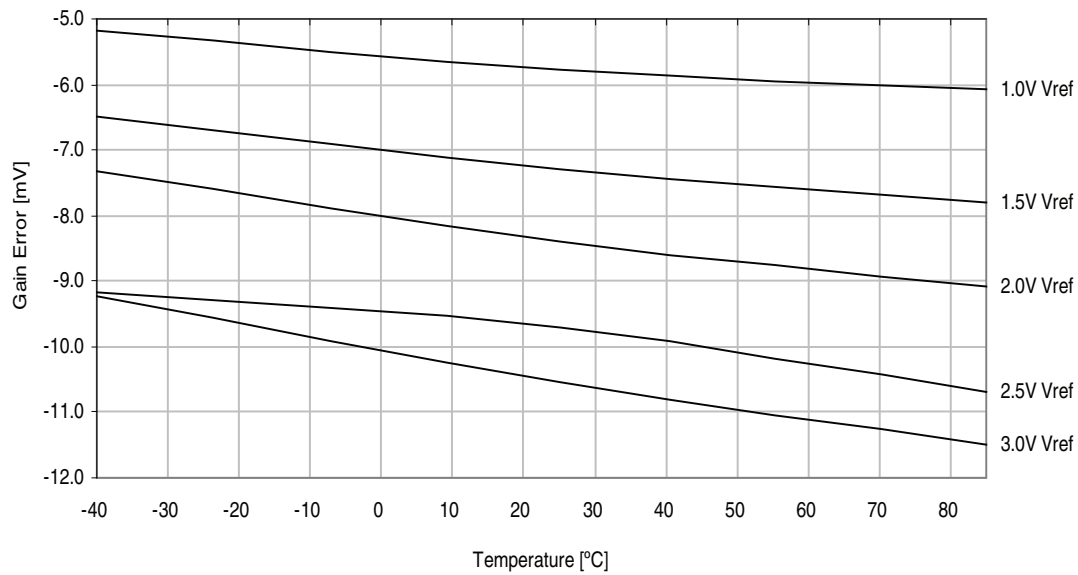
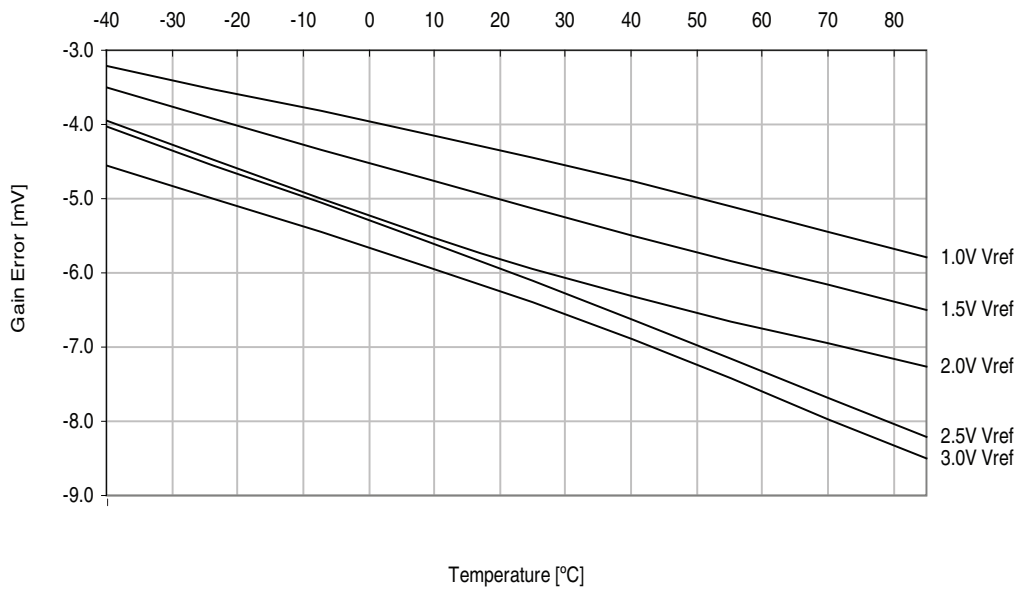

Figure 37-37. ADC Gain Error vs. Temperature.
SE Unsigned mode, $V_{CC} = 3.6V$, external reference.



37.4 Analog Comparator Characteristics

Figure 37-38. Analog comparator hysteresis vs. V_{CC} .
High-speed mode, small hysteresis.

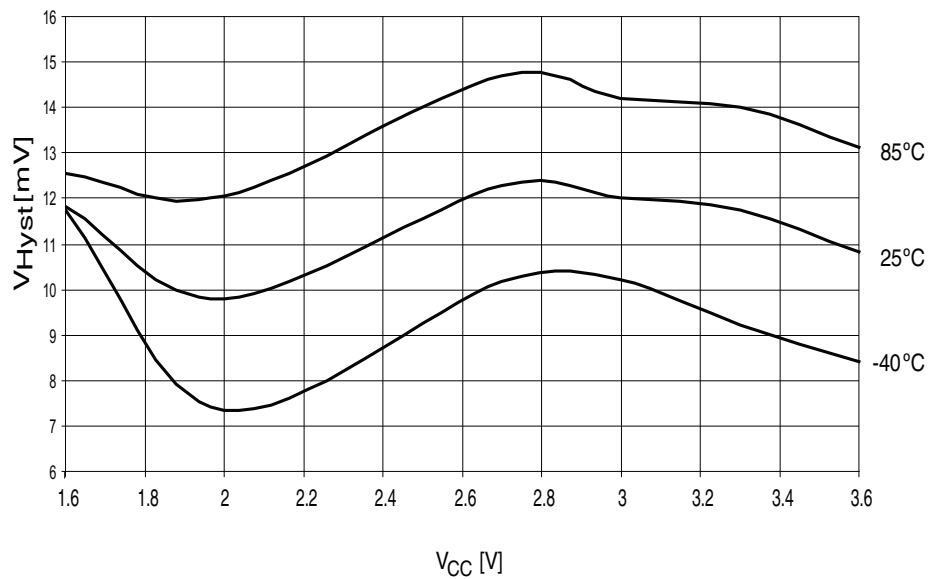

Figure 37-39. Analog comparator hysteresis vs. V_{CC} .
High-speed mode, large hysteresis.

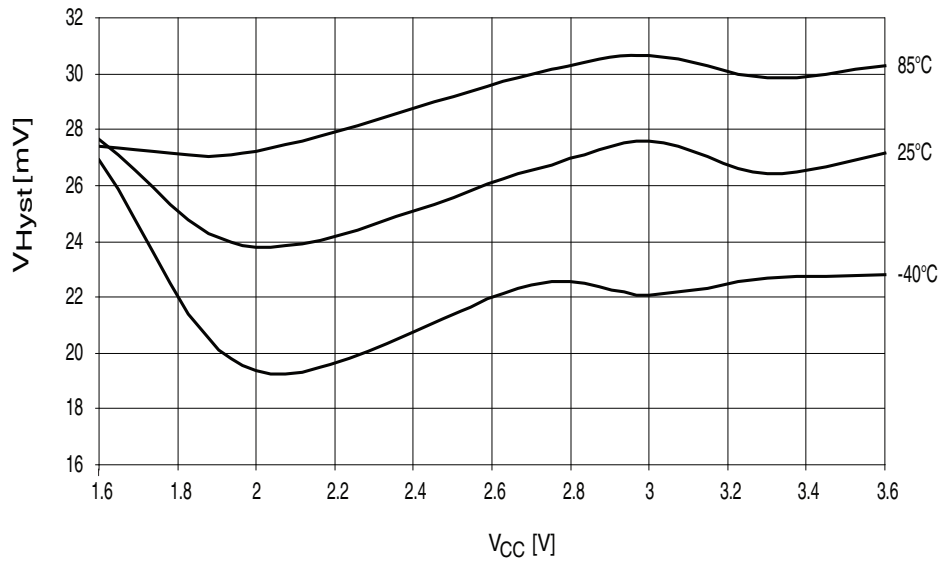

Figure 37-40. Analog comparator propagation delay vs. V_{CC} .
High speed mode.

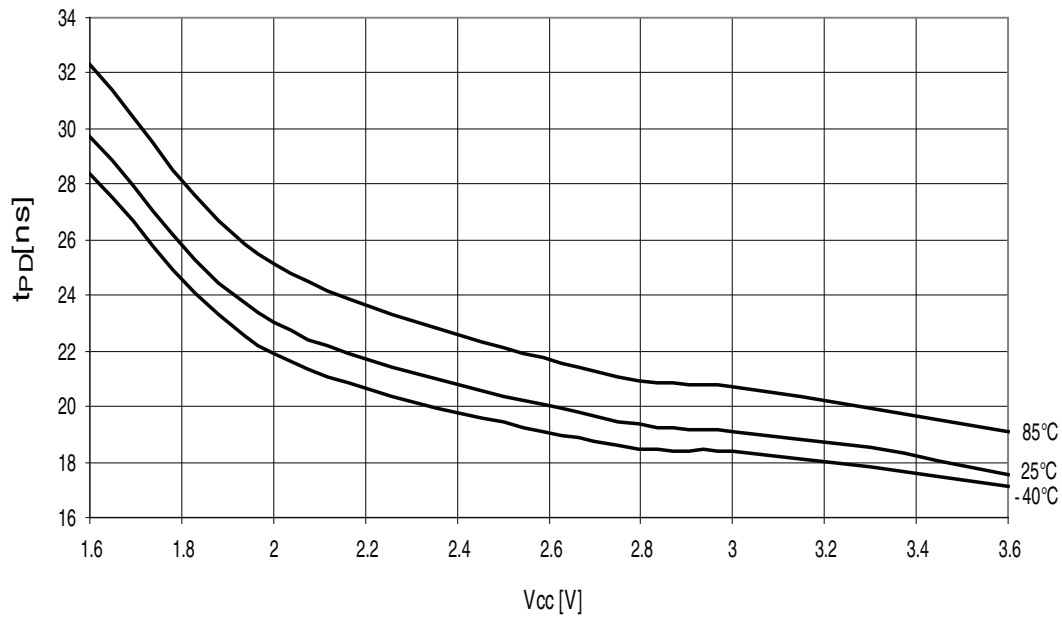

Figure 37-41. Analog comparator current consumption vs. V_{CC} .
High-speed mode.

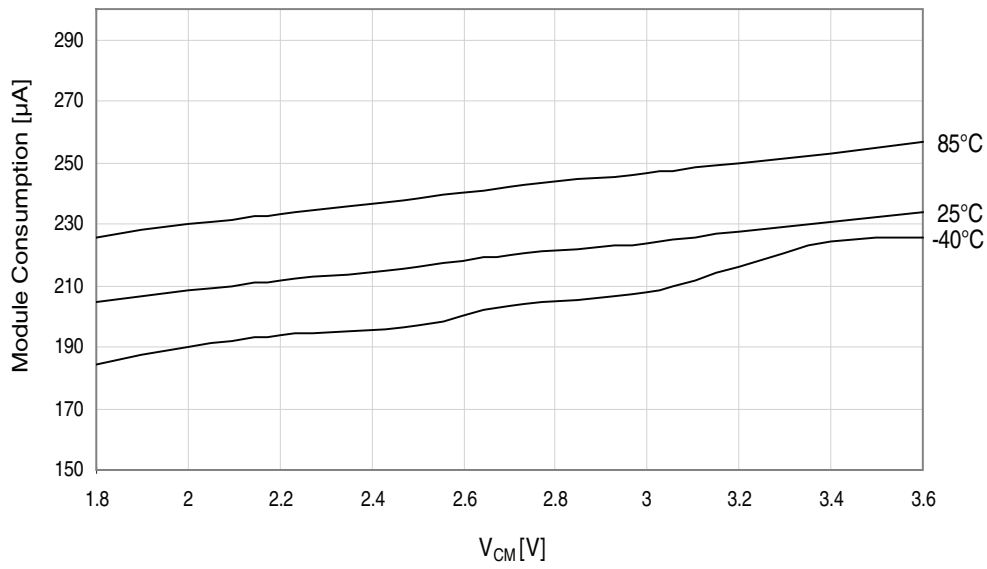

Figure 37-42. Analog comparator voltage scaler vs. SCALEFAC.
T = 25°C.

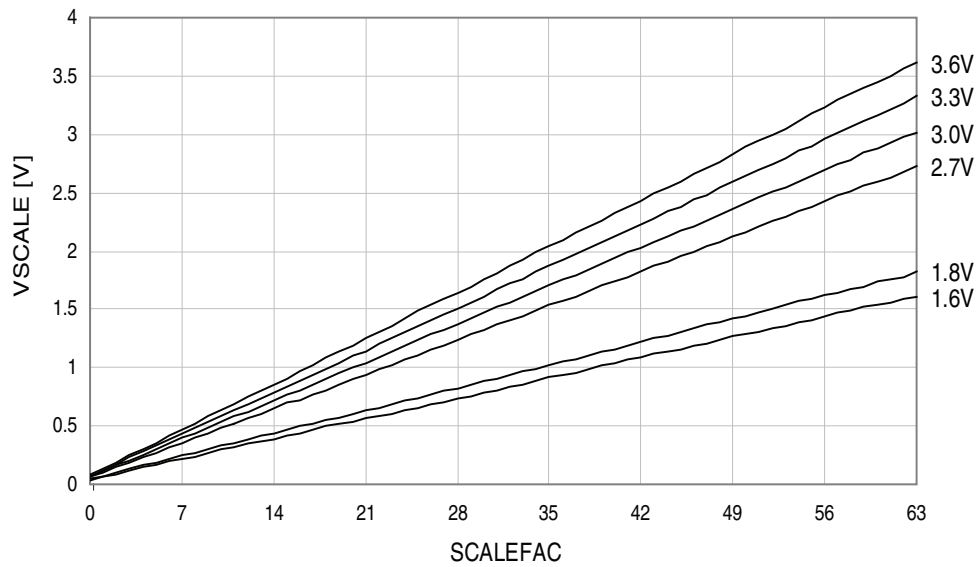

Figure 37-43. Analog comparator offset voltage vs. Common mode voltage.
High-speed mode.

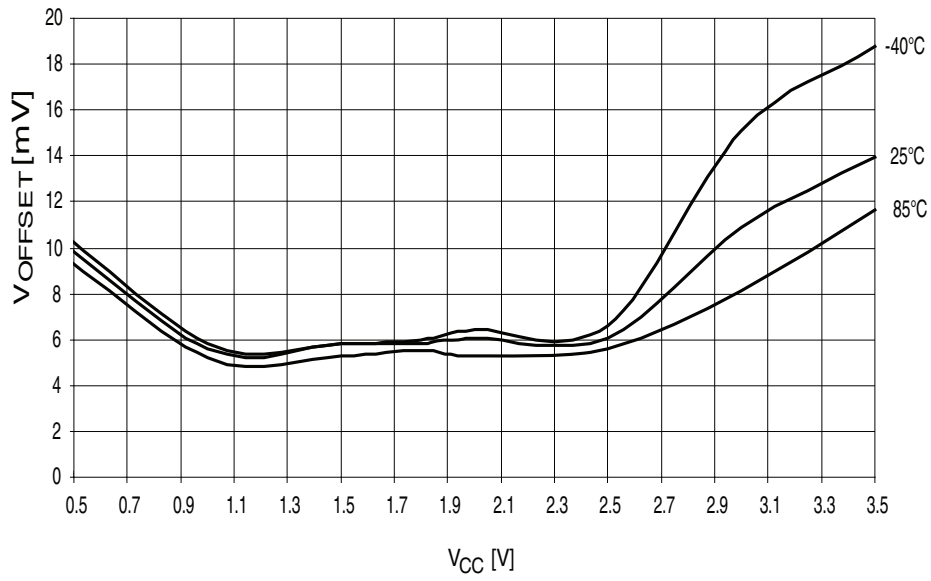
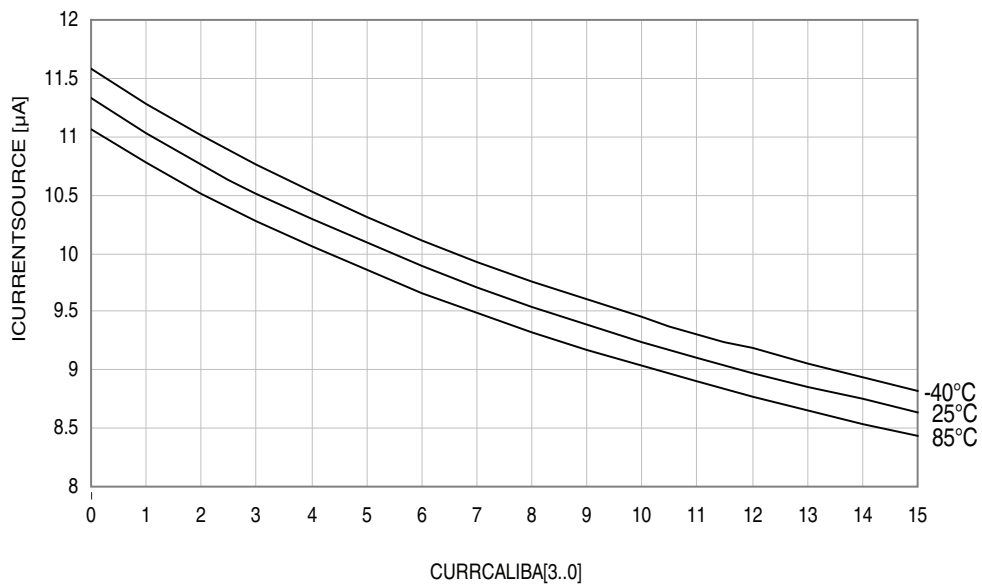
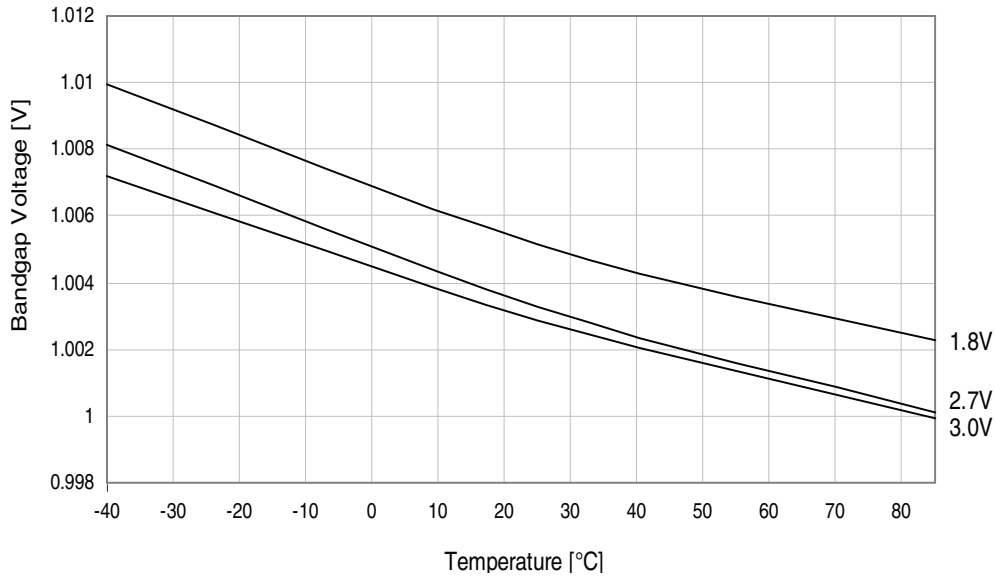

Figure 37-44. Analog comparator current source vs. Calibration.
V_{CC} = 3.0V, double mode.



37.5 Internal 1.0V reference Characteristics

Figure 37-45. ADC/DAC Internal 1.0V reference vs. temperature.



37.6 BOD Characteristics

Figure 37-46. BOD current consumption vs. V_{CC} .
Continuous mode, BOD level = 1.6V.

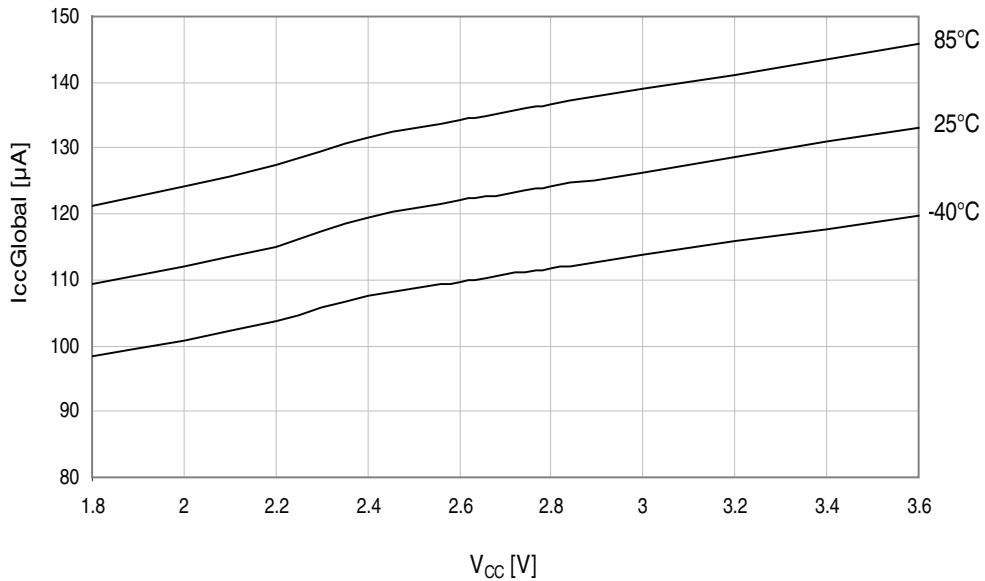

Figure 37-47. BOD current consumption vs. V_{CC} .
Sampled mode, BOD level = 1.6V.

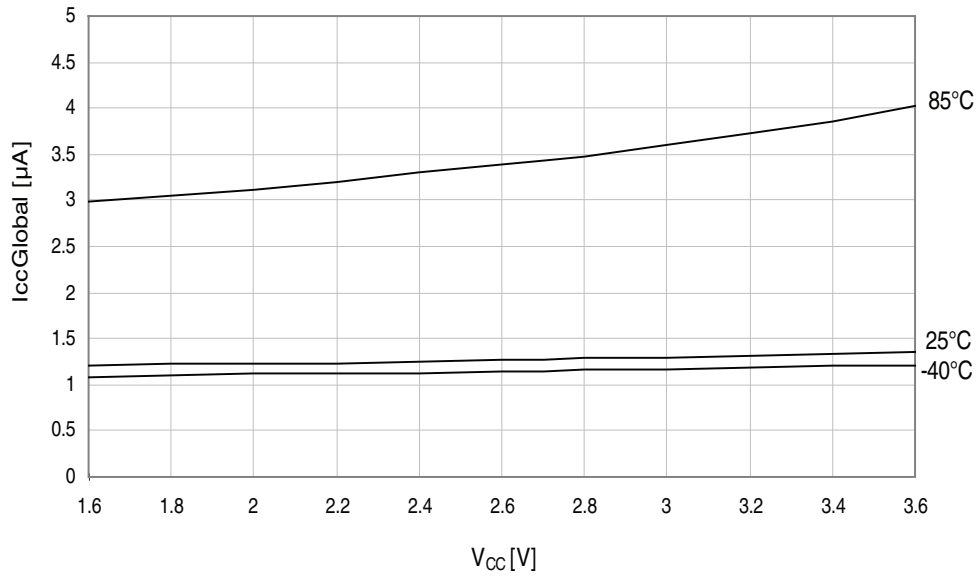

Figure 37-48. BOD thresholds vs. temperature.
BOD level = 1.6V.

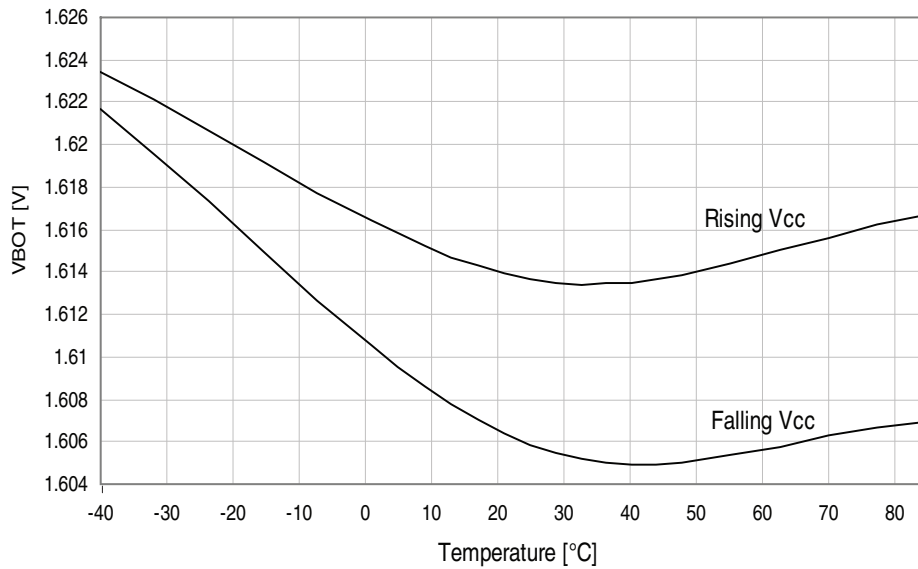

Figure 37-49. BOD thresholds vs. temperature.

BOD level = 2.2V.

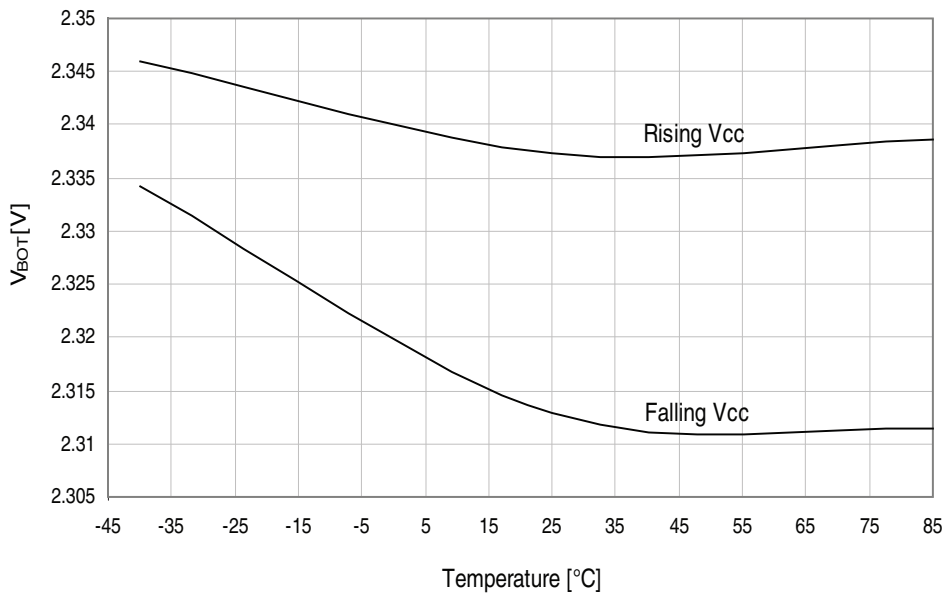
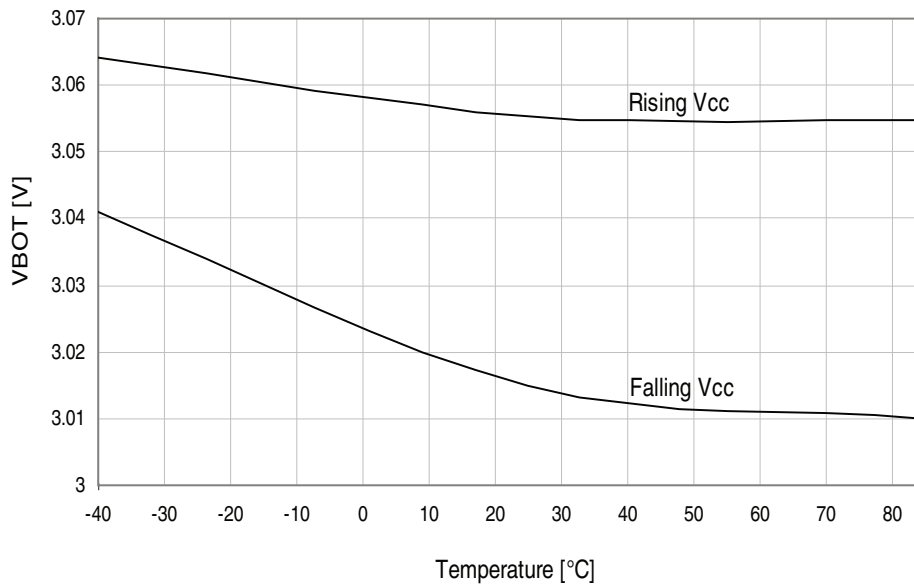

Figure 37-50. BOD thresholds vs. temperature.

BOD level = 3.0V.



37.7 External Reset Characteristics

Figure 37-51. Minimum Reset pin pulse width vs. V_{CC} .

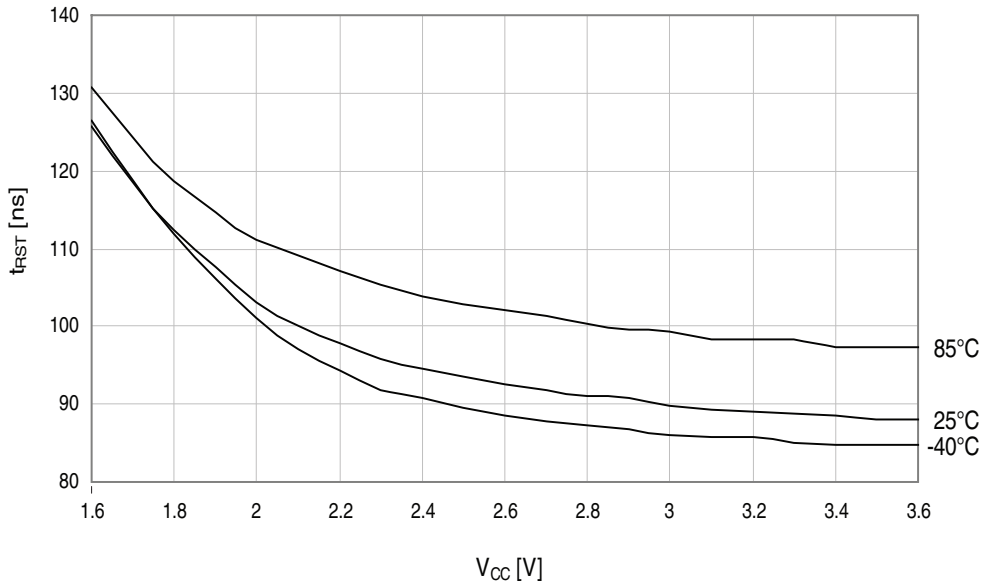

Figure 37-52. Reset pin pull-up resistor current vs. reset pin voltage.

$V_{CC} = 1.8V$.

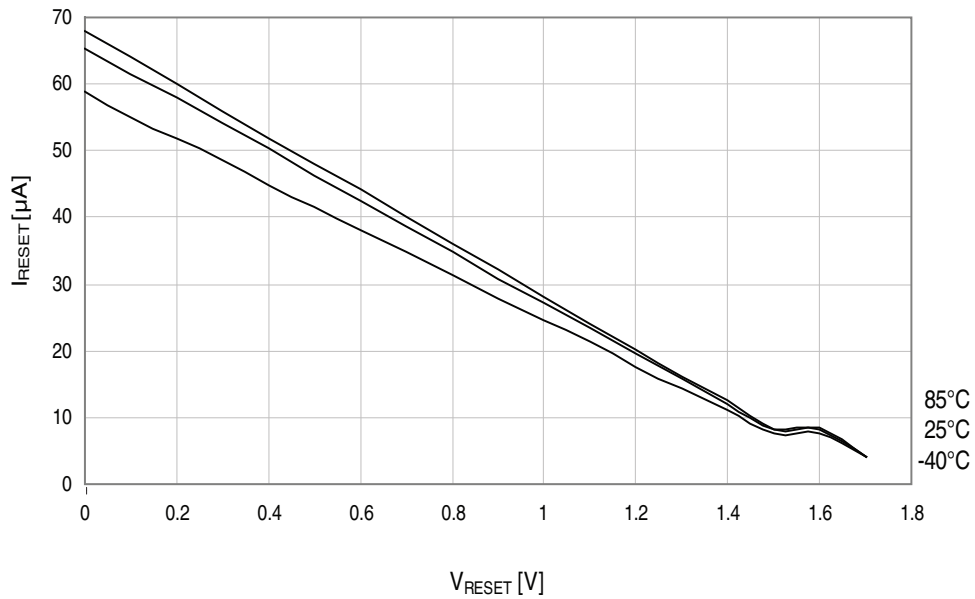

Figure 37-53. Reset pin pull-up resistor current vs. reset pin voltage.

$V_{CC} = 3.0V$.

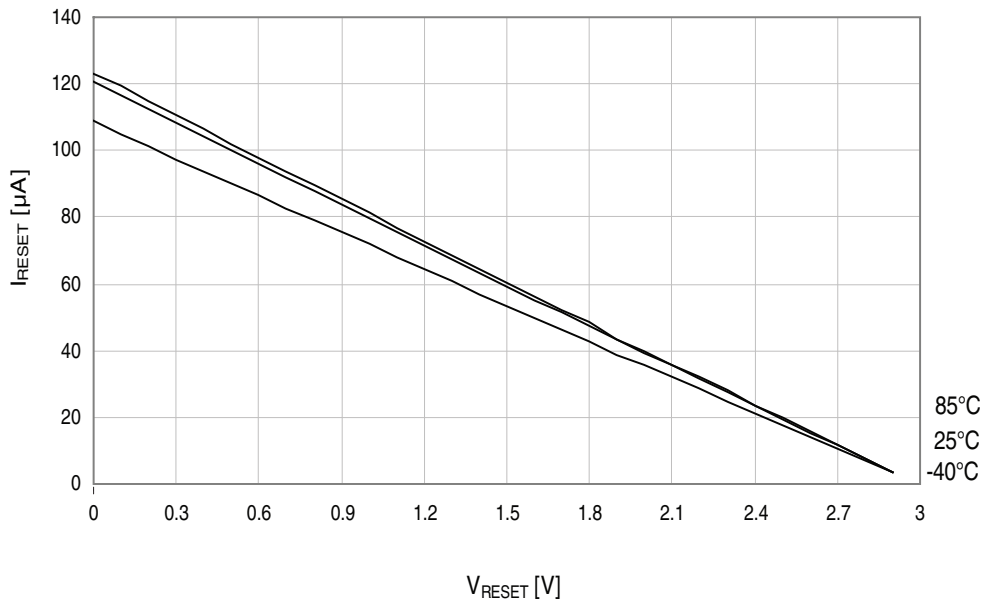

Figure 37-54. Reset pin pull-up resistor current vs. reset pin voltage.

$V_{CC} = 3.3V$.

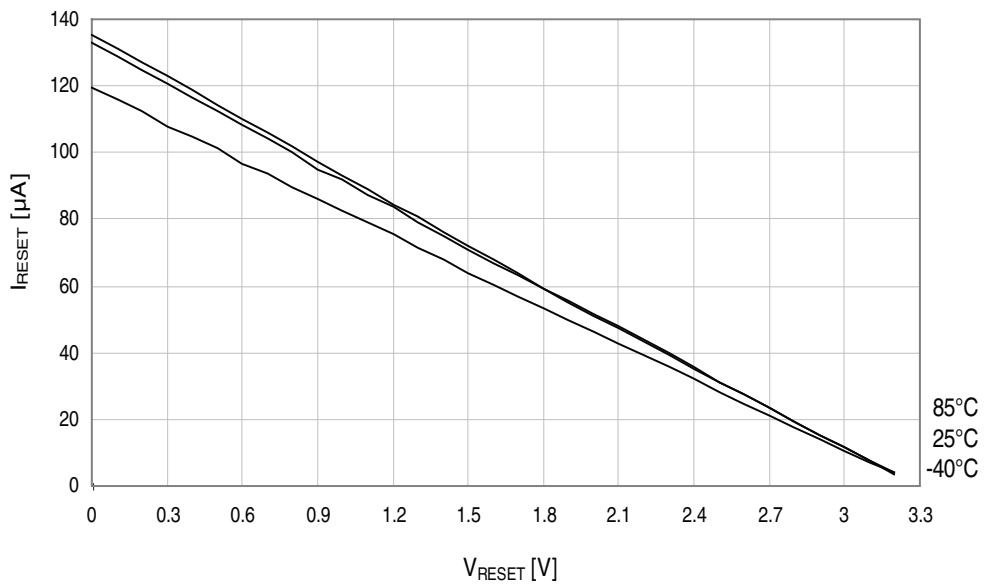

Figure 37-55. Reset pin input threshold voltage vs. V_{CC} .

V_{IH} - Reset pin read as "1".

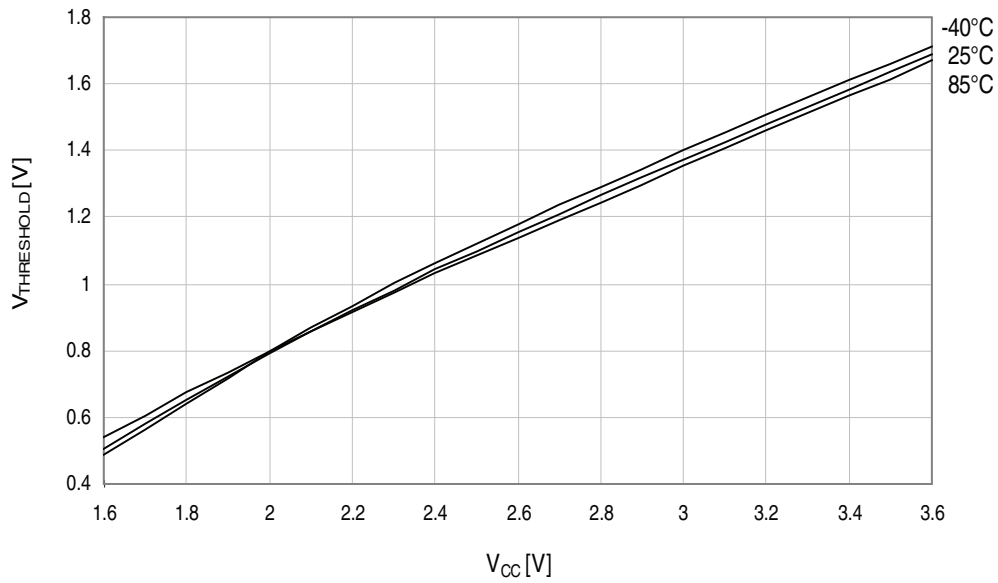
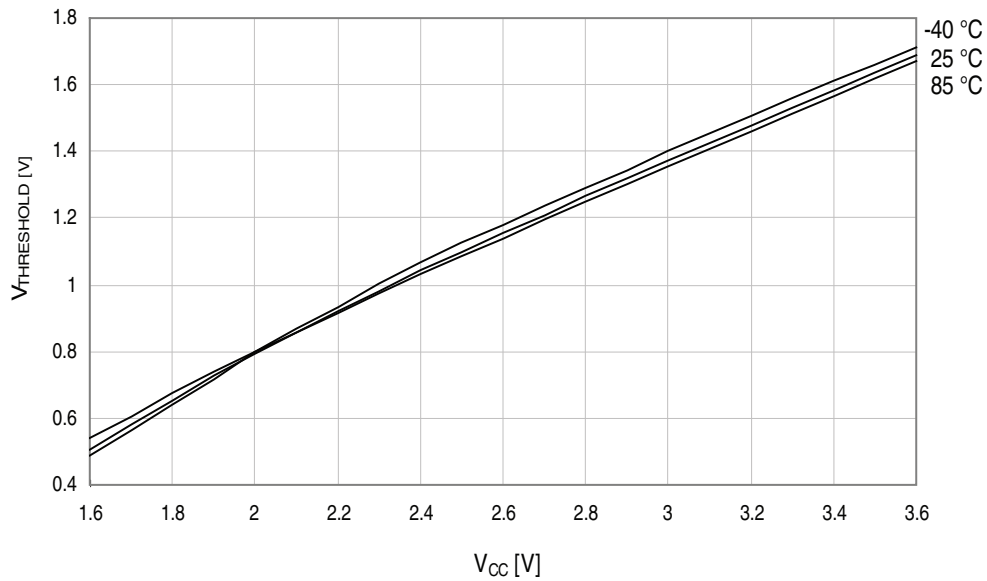

Figure 37-56. Reset pin input threshold voltage vs. V_{CC} .

V_{IL} - Reset pin read as "0".



37.8 Oscillator Characteristics

37.8.1 32.768kHz Internal Oscillator

Figure 37-57. 32.768kHz internal oscillator frequency vs. temperature.

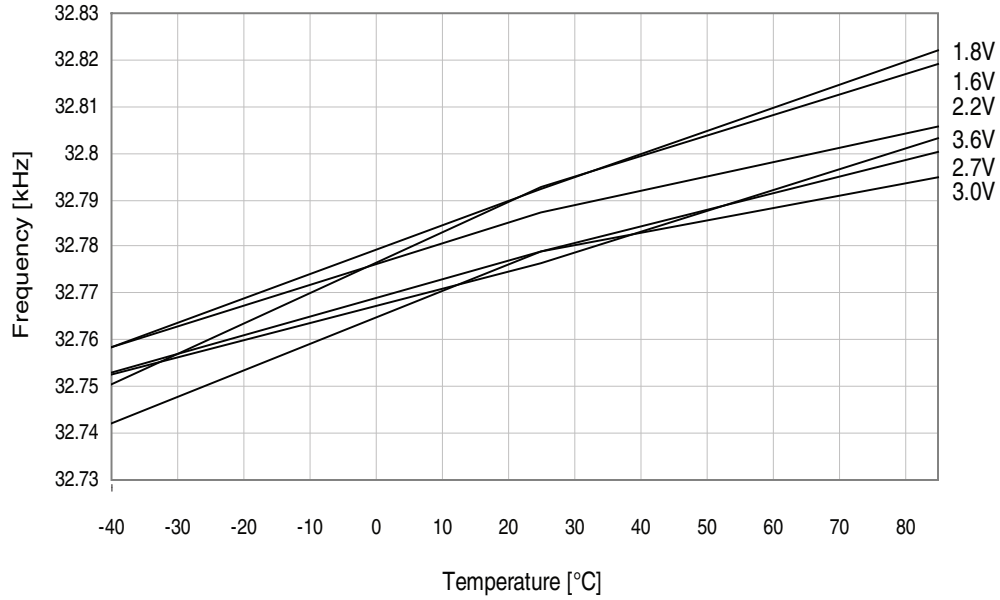

Figure 37-58. 32.768kHz ULP internal oscillator frequency vs. temperature.

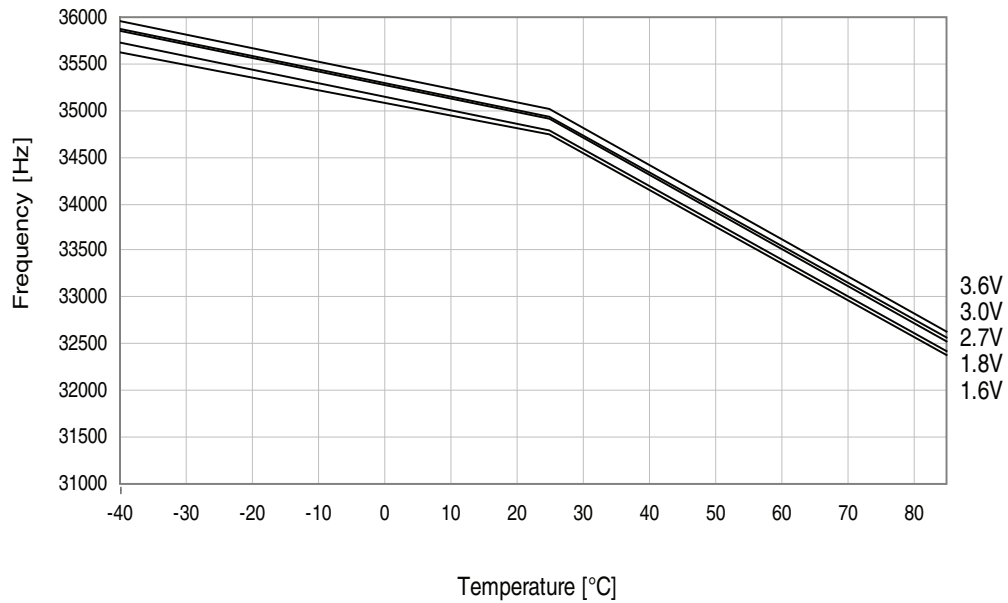

Figure 37-59. 32.768kHz internal oscillator calibration step size.

$T = -40^{\circ}\text{C}$ to 85°C , $V_{CC} = 3\text{V}$.

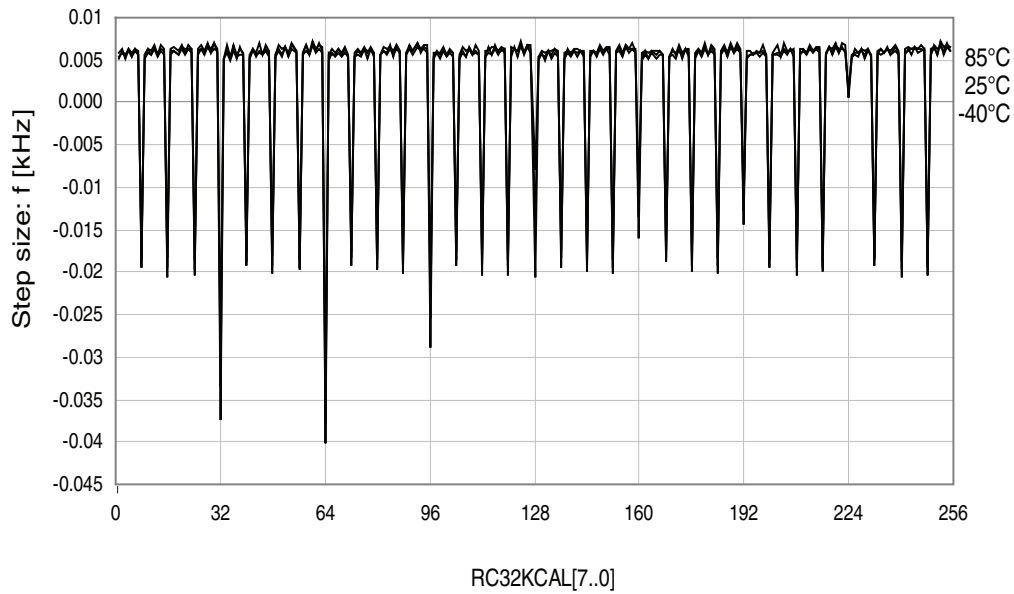
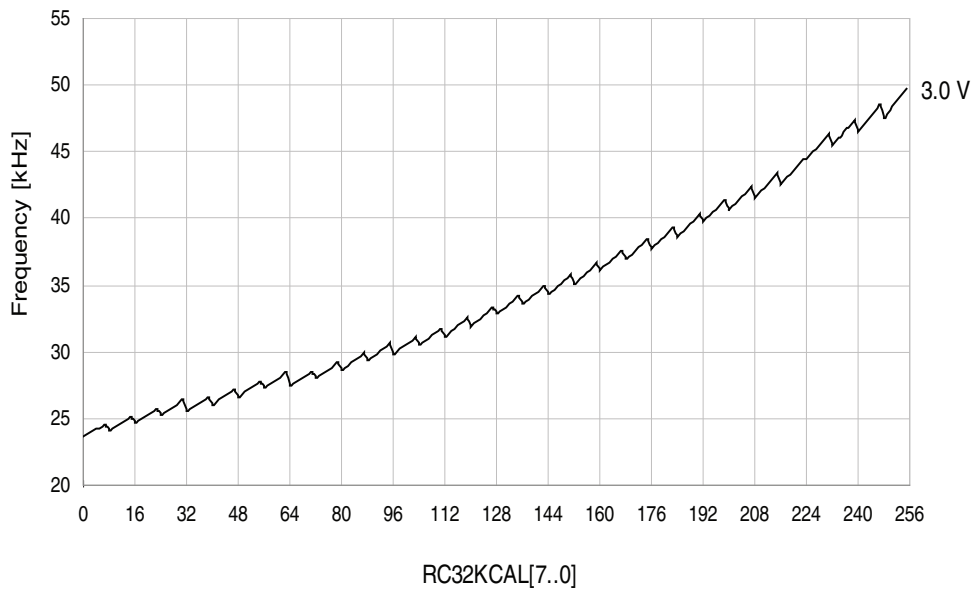

Figure 37-60. 32.768kHz internal oscillator frequency vs. calibration value.

$V_{CC} = 3.0\text{V}$, $T = 25^{\circ}\text{C}$.



37.8.2 2MHz Internal Oscillator

Figure 37-61. 2MHz internal oscillator frequency vs. temperature.
DPLL disabled.

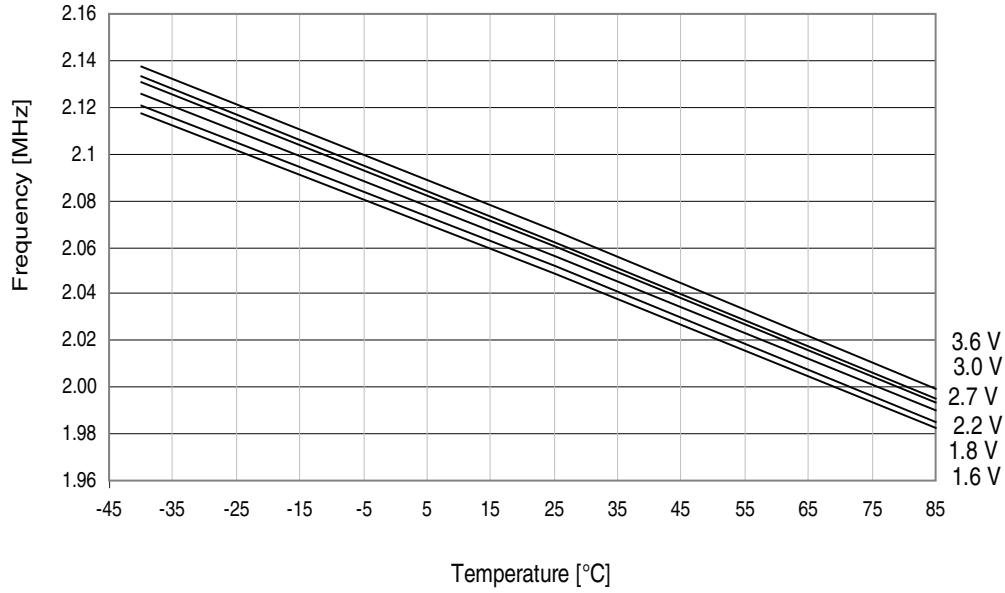

Figure 37-62. 2MHz internal oscillator frequency vs. temperature.
DPLL enabled.

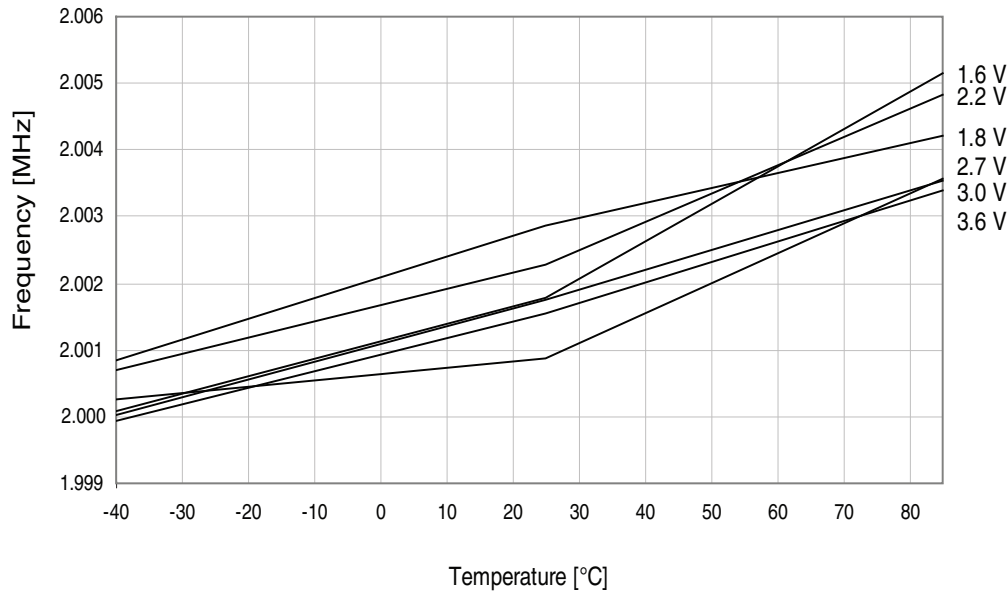

Figure 37-63. 2MHz internal oscillator CALA calibration step size.

$V_{CC} = 3V$.

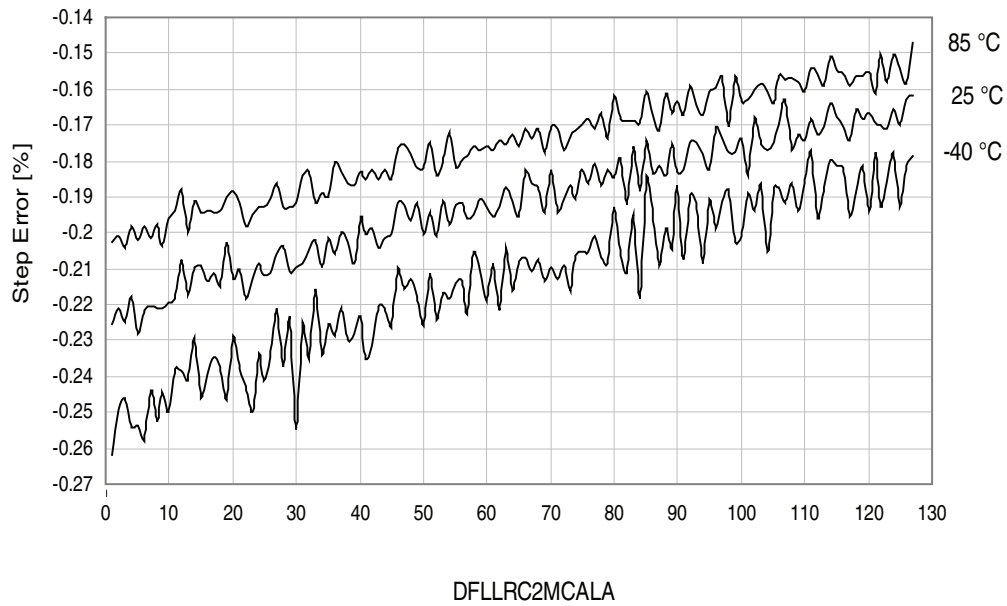
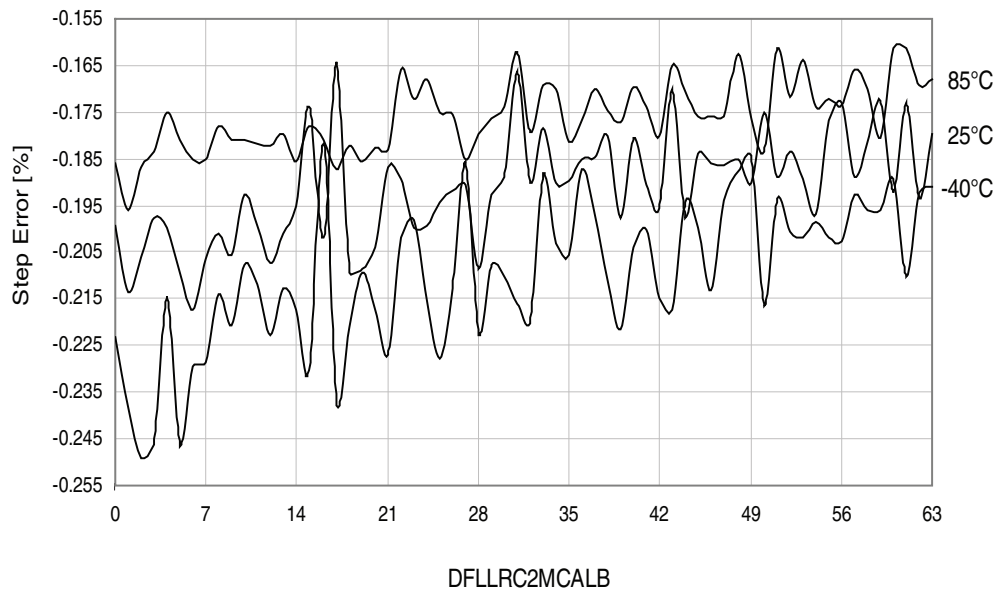

Figure 37-64. 2MHz internal oscillator CALB calibration step size.

$V_{CC} = 3V$, DPLL enabled.



37.8.3 32MHz Internal Oscillator

Figure 37-65. 32MHz internal oscillator frequency vs. temperature.
DPLL disabled.

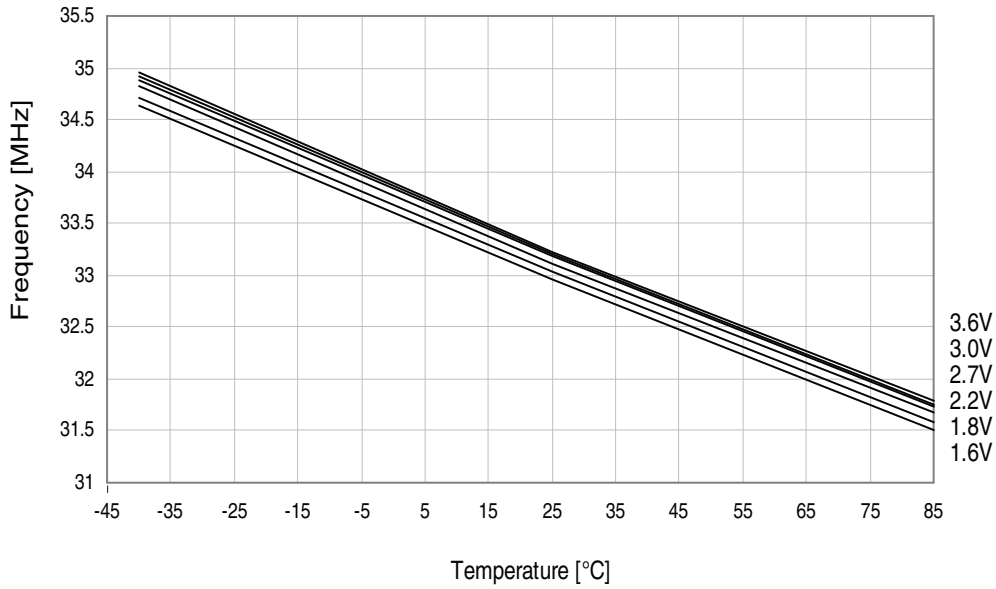

Figure 37-66. 32MHz internal oscillator frequency vs. temperature.
DPLL enabled, from the 32.768kHz internal oscillator.

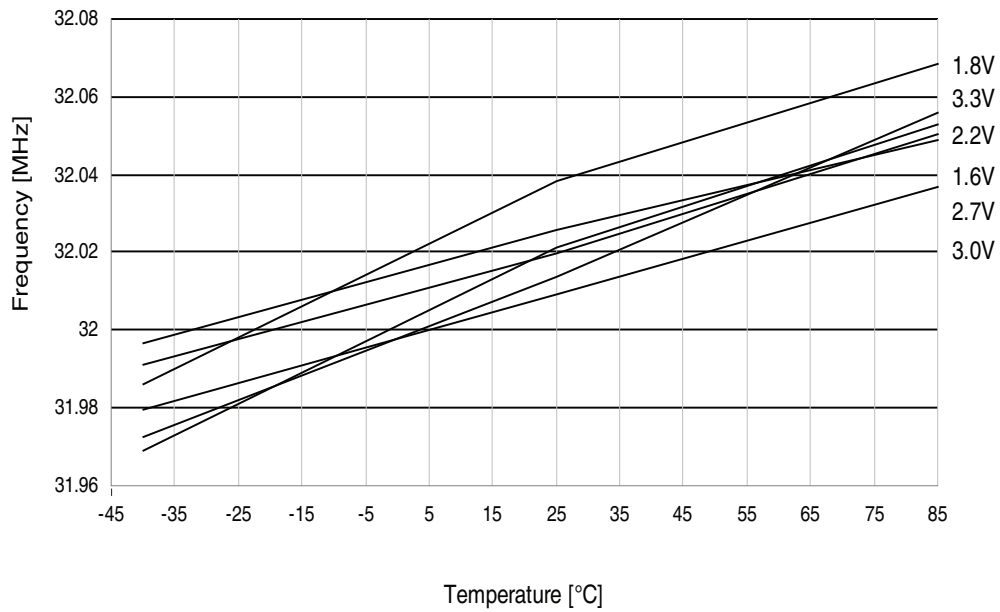

Figure 37-67. 32MHz internal oscillator CALA calibration step size.

$V_{CC} = 3.0V$.

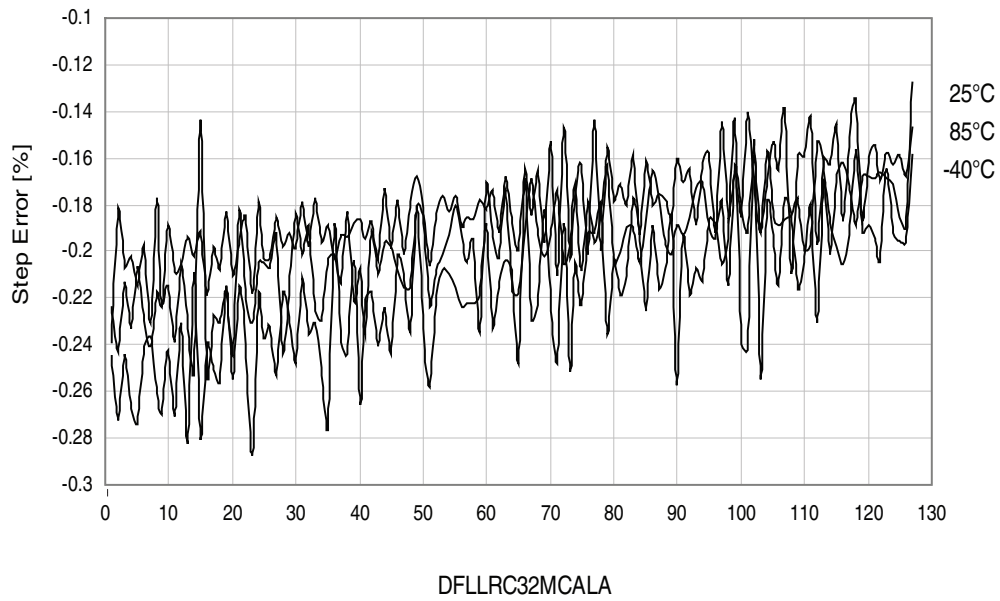

Figure 37-68. 32MHz internal oscillator CALB calibration step size.

$V_{CC} = 3.0V$, $CALA = mid\ value$.

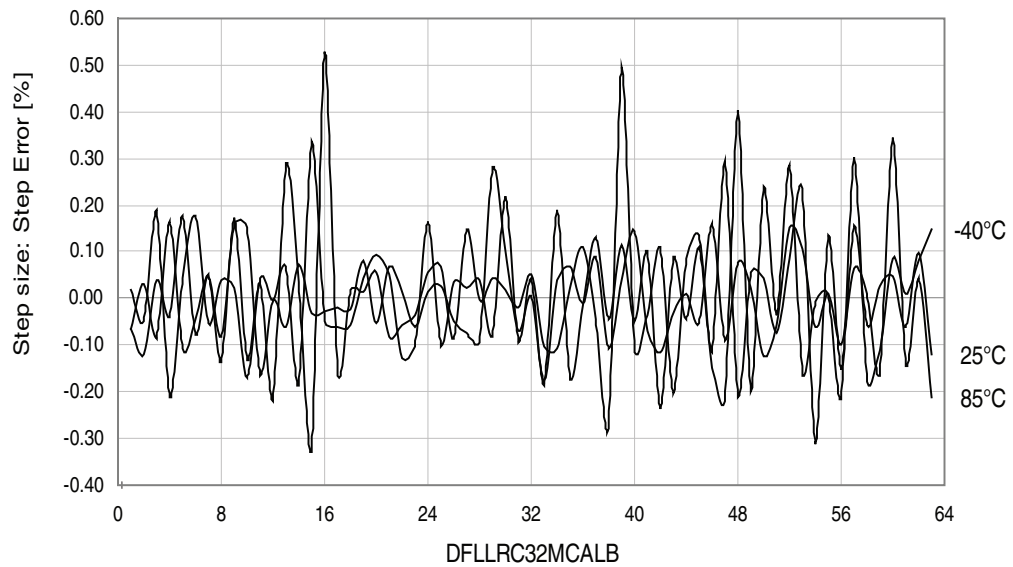

Figure 37-69. 32MHz internal oscillator frequency vs. CALA calibration value.

$V_{CC} = 3.0V$.

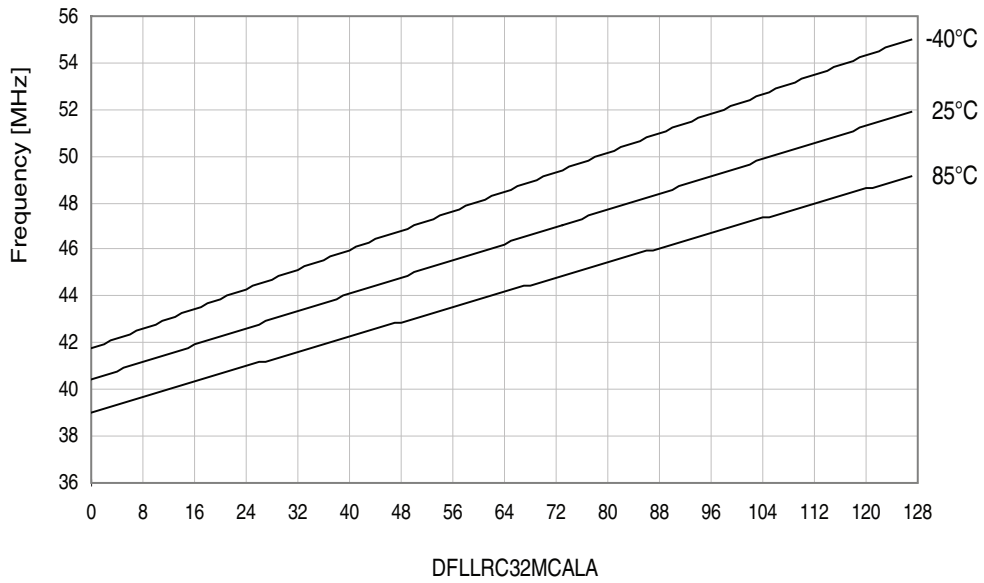
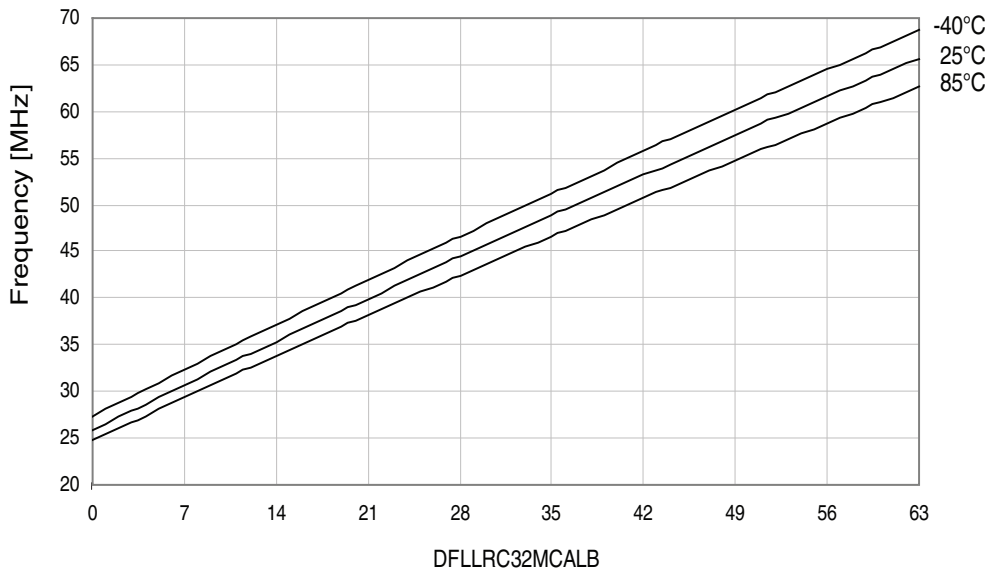

Figure 37-70. 32MHz internal oscillator frequency vs. CALB calibration value.

$V_{CC} = 3.0V$, *DFLL enabled*.



37.8.4 32MHz internal oscillator calibrated to 48MHz

Figure 37-71. 48MHz internal oscillator frequency vs. temperature.
DPLL disabled.

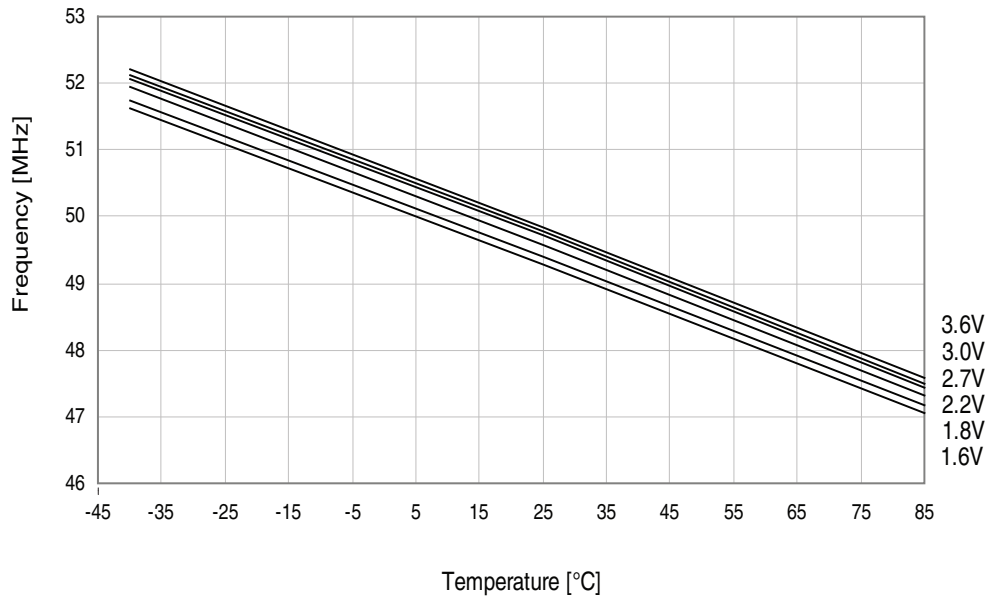

Figure 37-72. 48MHz internal oscillator frequency vs. temperature.
DPLL enabled, from the 32.768kHz internal oscillator.

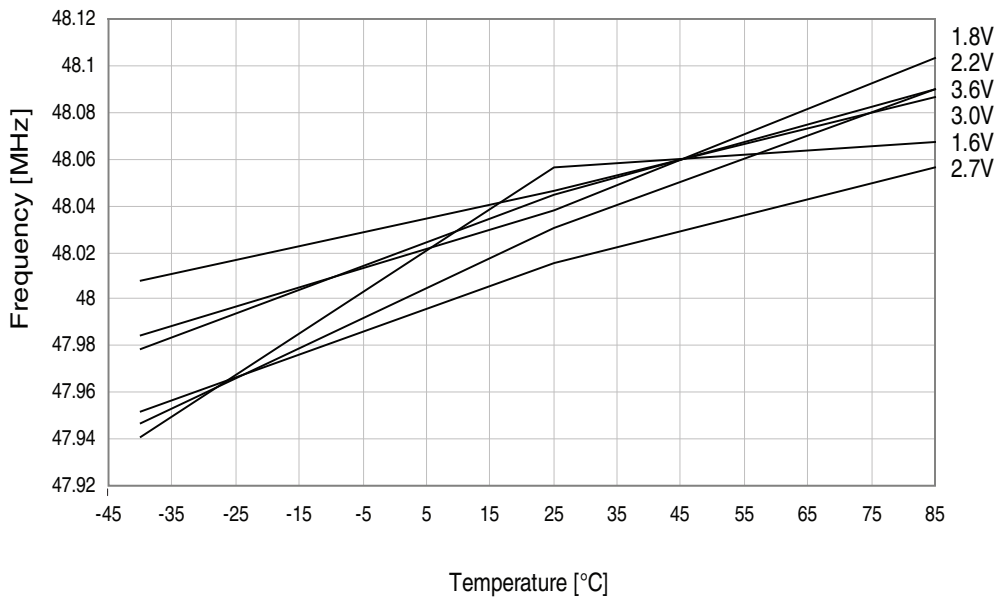

Figure 37-73. 32MHz internal oscillator CALA calibration step size.
Using 48MHz calibration value from signature row, $V_{CC} = 3.0V$.

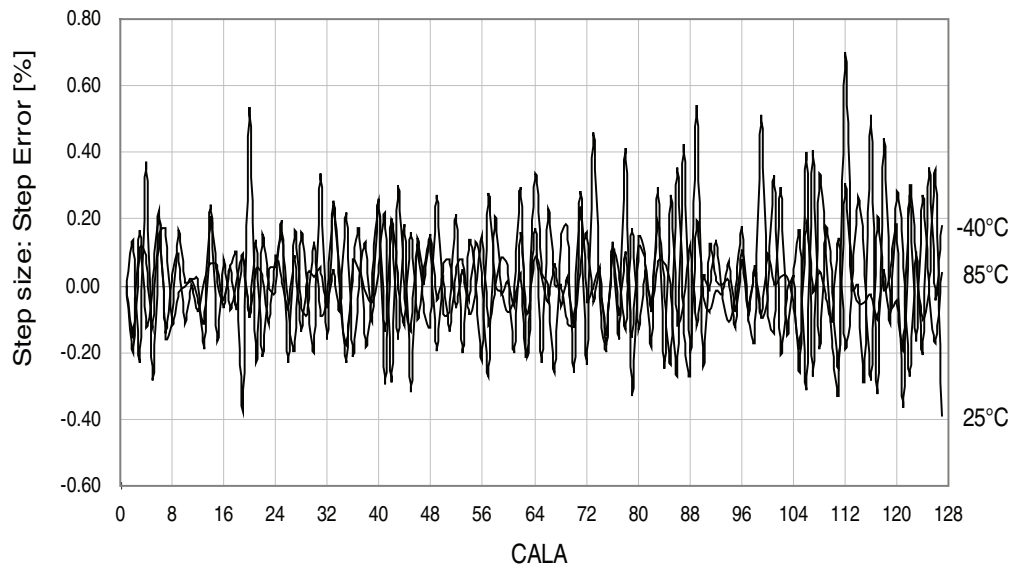
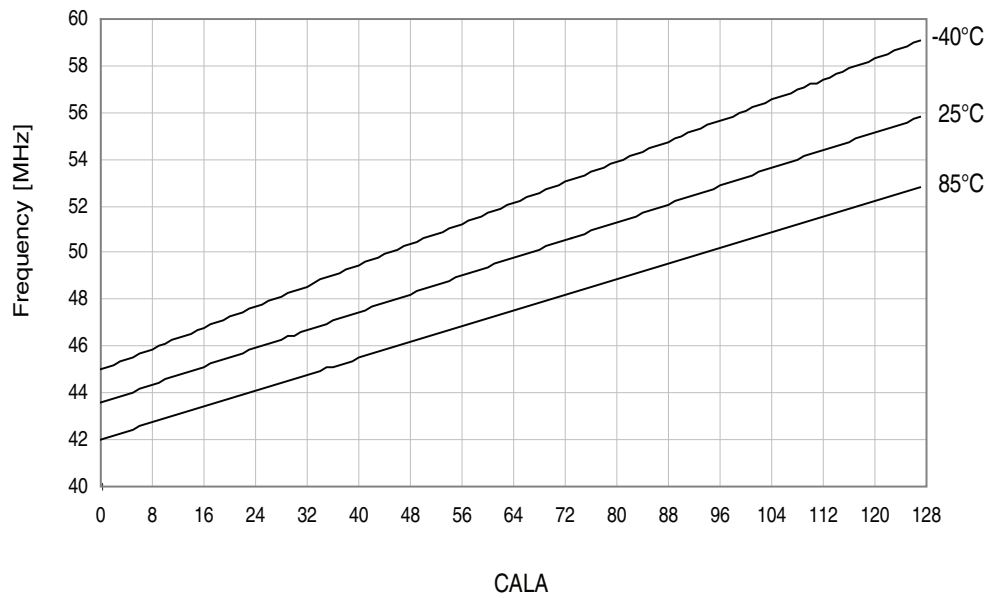
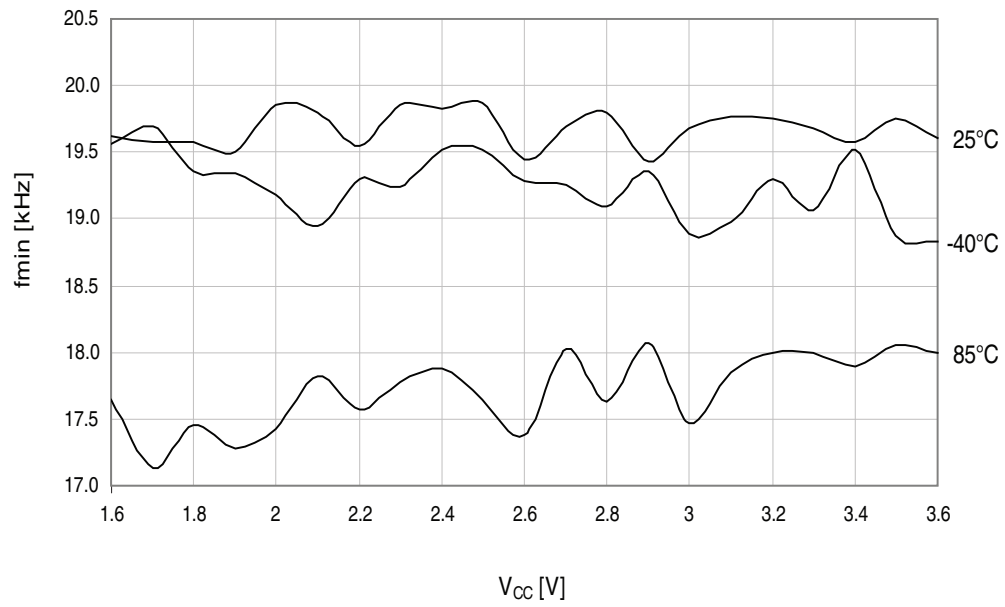

Figure 37-74. 48MHz internal oscillator frequency vs. CALA calibration value.
 $V_{CC} = 3.0V$.



37.9 PDI characteristics

Figure 37-75. Maximum PDI frequency vs. V_{CC} .



37.10 LCD Characteristics

Figure 37-76. I_{CC} vs. Frame Rate

32Hz Low Power Frame Rate from 32.768KHz TOSC, w/ and w/o pixel load, $V_{CC} = 1.8V$, $T = 25^{\circ}C$

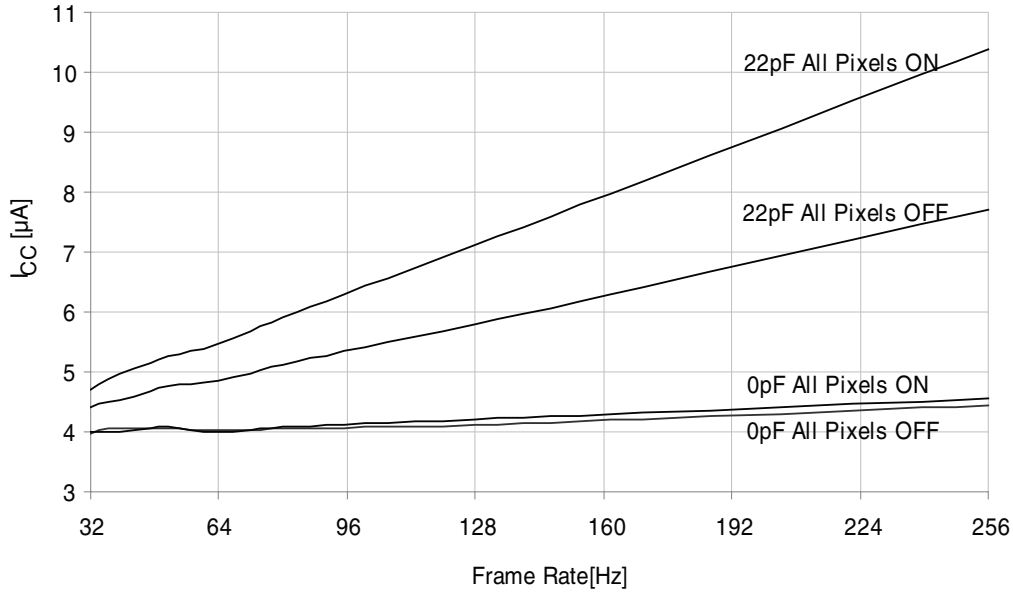

Figure 37-77. I_{CC} vs. Frame Rate

32Hz Low Power Frame Rate from 32.768KHz TOSC, w/ and w/o pixel load, $V_{CC} = 3.0V$, $T = 25^{\circ}C$

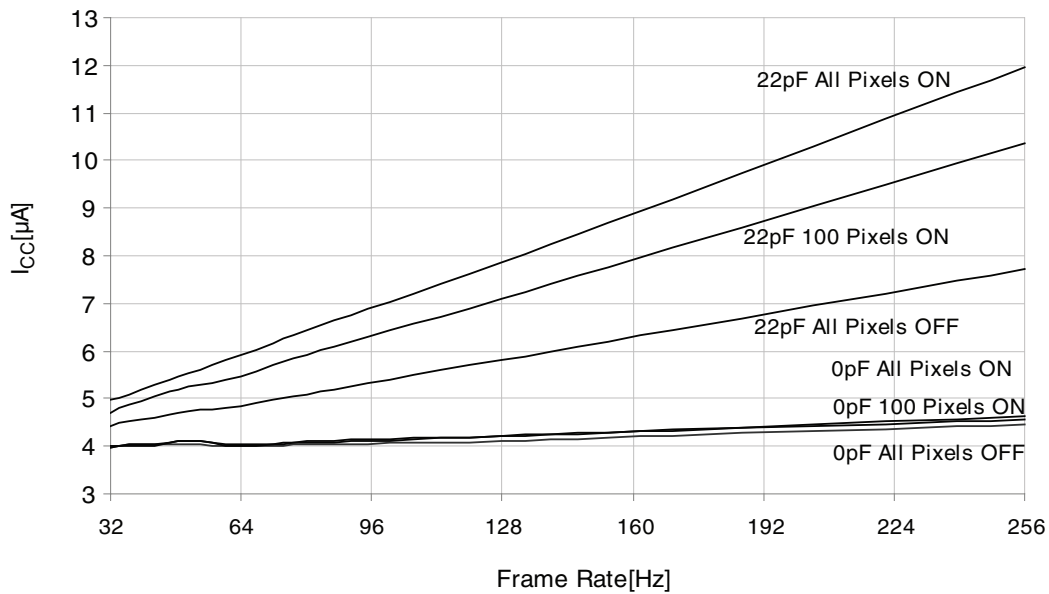

Figure 37-78. I_{CC} vs. Frame Rate
0pF load

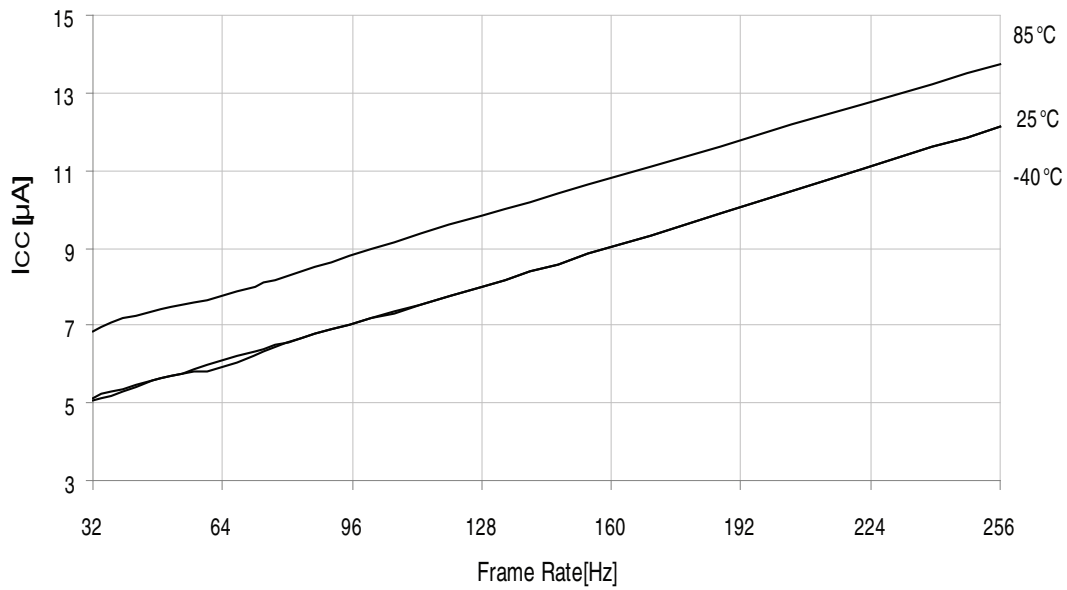

Figure 37-79. I_{CC} vs. Contrast
32Hz Low Power Frame Rate from 32.768KHz TOSC, w/o pixel load, $V_{CC} = 1.8V$

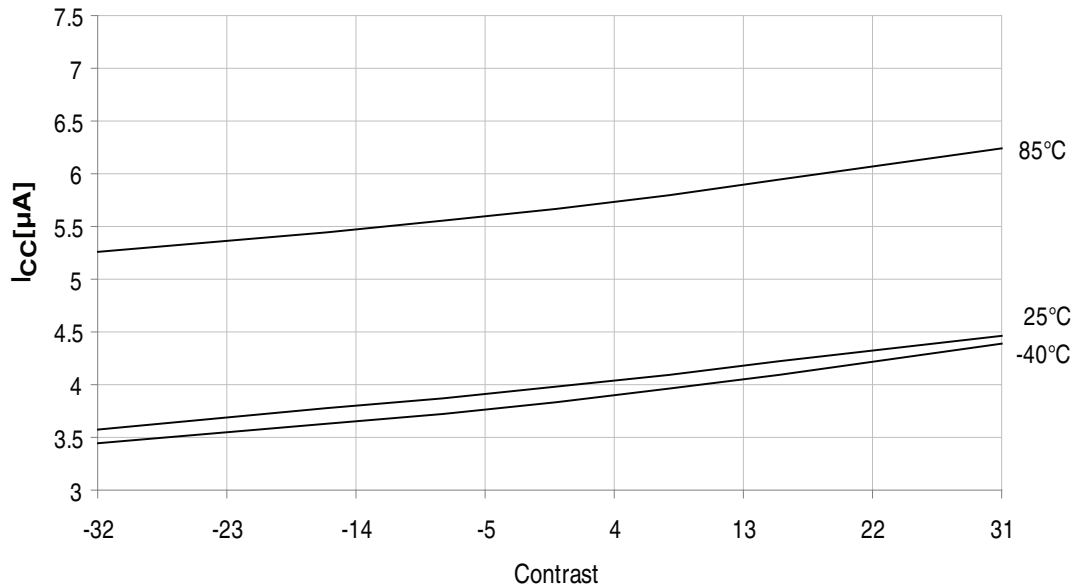

Figure 37-80. I_{CC} vs. Contrast

32Hz Low Power Frame Rate from 32.768KHz TOSC, w/o pixel load, $V_{CC} = 3.0V$

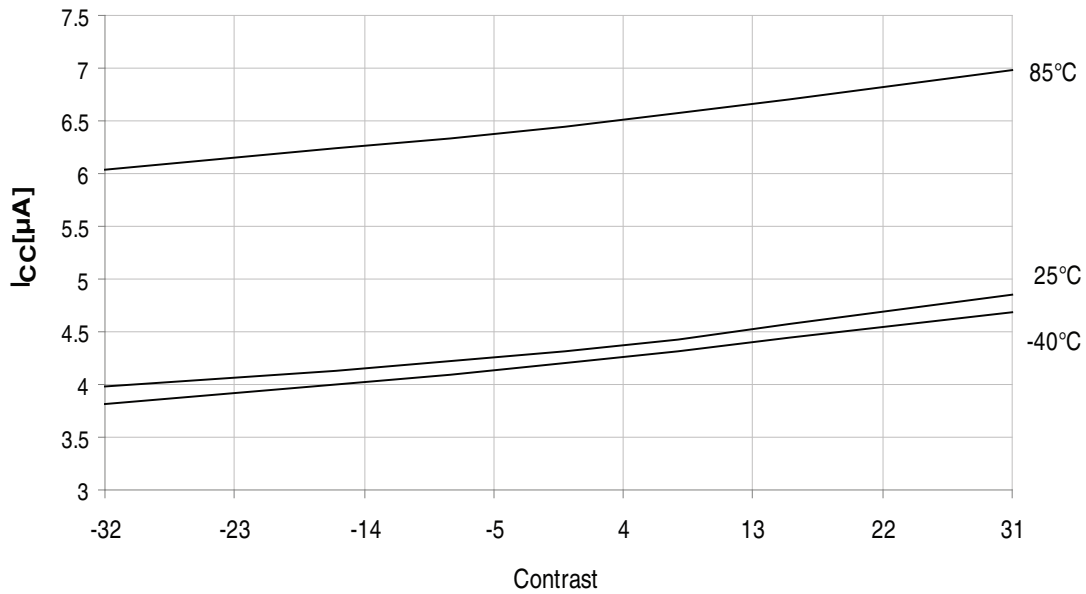

Figure 37-81. Psave LCD LP 32Hz vs. Temperature

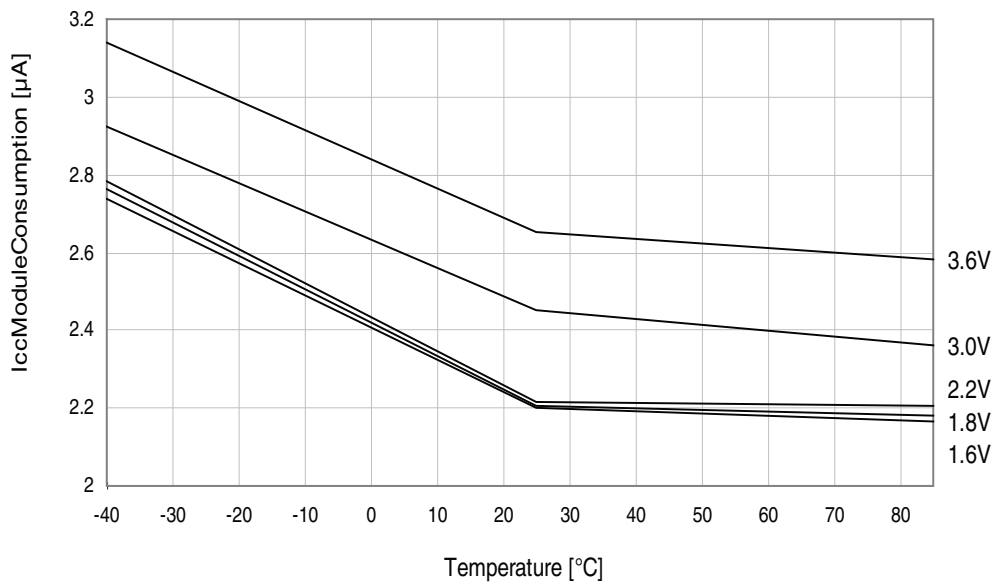

Figure 37-82. Psave LCD LP 32Hz vs. Temperature
RTC, WDT, BOD sampled

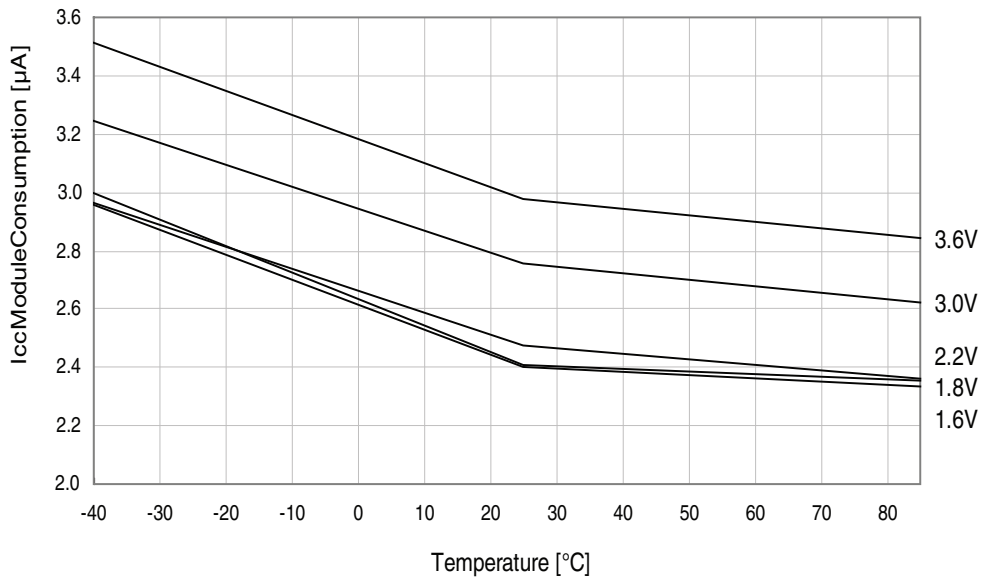
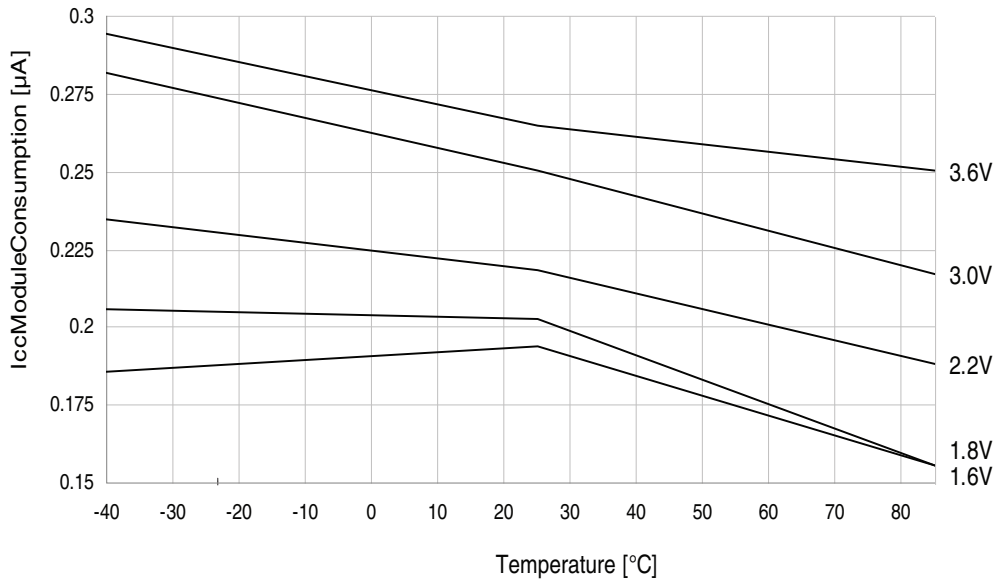

Figure 37-83. Psave vs. Temperature
RTC, WDT, BOD sampled.



38. Errata

38.1 ATxmega64B1, ATxmega128B1

38.1.1 Rev. C

- Device revision number
- AWeX fault protection restore is not done correct in Pattern Generation Mode

1. Device revision number is unchanged between rev. B and rev. C

2. AWeX fault protection restore is not done correctly in Pattern Generation Mode

When a fault is detected the OUTOVEN register is cleared, and when fault condition is cleared, OUTOVEN is restored according to the corresponding enabled DTI channels. For Common Waveform Channel Mode (CWCM), this has no effect as the OUTOVEN is correct after restoring from fault. For Pattern Generation Mode (PGM), OUTOVEN should instead have been restored according to the DTILSBUF register.

Problem fix/Workaround

For CWCM no workaround is required.

For PGM in latched mode, disable the DTI channels before returning from the fault condition. Then, set correct OUTOVEN value and enable the DTI channels, before the direction (DIR) register is written to enable the correct outputs again.

For PGM in cycle-by-cycle mode there is no workaround.

38.1.2 Rev. B

Not sampled.

38.1.3 Rev. A

- Power down consumption
- ADC conversion error when x0.5 gain is used

1. Power Down consumption

After reset, when system enters in power down or when ADC is disabled, extra power consumption is drawn.

Problem fix/Workaround

Set ADC to a configuration different from differential mode.

2. ADC conversion error when x0.5 gain is used

When the gain is set to x0.5, the conversion result is similar to the gain setting x1.

Problem fix/Workaround

There is no workaround.

39. Datasheet Revision History

Please note that the referring page numbers in this section are referred to this document. The referring revision in this section are referring to the document revision.

39.1 8330F – 02/2014

1.	Added the correct VFBGA package drawing: <ul style="list-style-type: none">• Replaced the package 100C1 (CBGA) by the package 7A1 (VFBGA)• Updated the package type in “Ordering Information” on page 2• Updated the title in Figure 2-2 on page 4 and in the Table 2-1 on page 4• Updated the package type in “Typical Characteristics” on page 92
2.	Updated the title name of the Table 36-24 on page 83

39.2 8330E – 06/2013

1.	Added pinout for CBGA package option: Figure 2-2 and Table 2-1 on page 4 .
----	--

39.3 8330D – 01/2013

1.	Updated “Ordering Information” on page 2 : Added -AUR, -CU and -CUR options.
2.	Updated “Packaging information” : Added package drawing for “7A1” on page 69
3.	Updated Table 32-5 on page 58 : PDI and RESET pins updated.
4.	Updated pin number for PR1 to pin 81 in Table 32-8 on page 61 .
5.	Updated “External clock with prescaler for system clock” Table 36-26 on page 85
6.	Added ESR parameter to the “External 16MHz crystal oscillator and XOSC characteristics.” Table 36-27 on page 85 .

39.4 8330C – 07/2012

1.	Updated the Table 32-4 on page 58 . PDI_CLOCK is on pin 16 and PDI_DATA on pin 15.
2.	Updated the datasheet using the Atmel new template.
3.	Updated “Errata” , “Rev. C” on page 134 : “JTAG revision” replaced by “Device revision number” .

39.5 8330B – 02/2012

1. Updated the [Table 7-2 on page 16](#). The page size (words) for ATxmega128B1 changed from 256 to 128.
2. Updated all [“Electrical Characteristics” on page 70](#).
3. Updated all [“Typical Characteristics” on page 92](#).
4. Updated [“Errata” on page 134](#).

39.6 8330A – 10/2011

1. Initial revision.

Table Of Contents

Features	1
1. Ordering Information	2
2. Pinout/Block Diagram	3
3. Overview	5
3.1 Block Diagram.	6
4. Resources	7
4.1 Recommended reading.	7
5. Capacitive touch sensing	7
6. AVR CPU	8
6.1 Features	8
6.2 Overview	8
6.3 Architectural Overview	8
6.4 ALU - Arithmetic Logic Unit.	9
6.5 Program Flow	10
6.6 Status Register	10
6.7 Stack and Stack Pointer	10
6.8 Register File	10
7. Memories	12
7.1 Features	12
7.2 Overview	12
7.3 Flash Program Memory	13
7.4 Fuses and Lock bits	14
7.5 Data Memory	14
7.6 EEPROM	15
7.7 I/O Memory	15
7.8 Data Memory and Bus Arbitration.	15
7.9 Memory Timing.	15
7.10 Device ID and Revision.	15
7.11 JTAG Disable	16
7.12 I/O Memory Protection	16
7.13 Flash and EEPROM Page Size	16
8. DMAC – Direct Memory Access Controller	17
8.1 Features	17
8.2 Overview	17
9. Event System	18
9.1 Features	18
9.2 Overview	18
10. System Clock and Clock options	20
10.1 Features	20
10.2 Overview	20
10.3 Clock Sources.	21

11. Power Management and Sleep Modes	23
11.1 Features	23
11.2 Overview	23
11.3 Sleep Modes	23
12. System Control and Reset	25
12.1 Features	25
12.2 Overview	25
12.3 Reset Sequence	25
12.4 Reset Sources	25
13. WDT – Watchdog Timer	27
13.1 Features	27
13.2 Overview	27
14. Interrupts and Programmable Multilevel Interrupt Controller	28
14.1 Features	28
14.2 Overview	28
14.3 Interrupt vectors	28
15. I/O Ports	30
15.1 Features	30
15.2 Overview	30
15.3 Output Driver	30
15.4 Input sensing	33
15.5 Alternate Port Functions	33
16. T/C – 16-bit Timer/Counter Type 0 and 1	34
16.1 Features	34
16.2 Overview	34
17. TC2 – 16-bit Timer/Counter Type 2	36
17.1 Features	36
17.2 Overview	36
18. AWeX – Advanced Waveform Extension	37
18.1 Features	37
18.2 Overview	37
19. Hi-Res – High Resolution Extension	38
19.1 Features	38
19.2 Overview	38
20. RTC – 16-bit Real-Time Counter	39
20.1 Features	39
20.2 Overview	39
21. USB – Universal Serial Bus Interface	40
21.1 Features	40
21.2 Overview	40
22. TWI – Two Wire Interface	42
22.1 Features	42

22.2	Overview	42
23.	SPI – Serial Peripheral Interface	43
23.1	Features	43
23.2	Overview	43
24.	USART	44
24.1	Features	44
24.2	Overview	44
25.	IRCOM – IR Communication Module	45
25.1	Features	45
25.2	Overview	45
26.	AES and DES Crypto Engine	46
26.1	Features	46
26.2	Overview	46
27.	CRC – Cyclic Redundancy Check Generator	47
27.1	Features	47
27.2	Overview	47
28.	LCD - Liquid Crystal Display Controller	48
28.1	Features	48
28.2	Overview	48
29.	ADC – 12-bit Analog to Digital Converter	49
29.1	Features	49
29.2	Overview	49
30.	AC – Analog Comparator	51
30.1	Features	51
30.2	Overview	51
31.	Programming and Debugging	53
31.1	Features	53
31.2	Overview	53
32.	Pinout and Pin Functions	54
32.1	Alternate Pin Function Description	54
32.2	Alternate Pin Functions	57
33.	Peripheral Module Address Map	61
34.	Instruction Set Summary	63
35.	Packaging information	68
35.1	100A	68
35.2	7A1	69
36.	Electrical Characteristics	70
36.1	Absolute Maximum Ratings	70
36.2	General Operating Ratings	70
36.3	DC Characteristics	72

36.4	Wake-up time from sleep modes	75
36.5	I/O Pin Characteristics	76
36.6	Liquid Crystal Display Characteristics.	77
36.7	ADC characteristics	77
36.8	Analog Comparator Characteristics	80
36.9	Bandgap and Internal 1.0V Reference Characteristics.	80
36.10	Brownout Detection Characteristics	81
36.11	External Reset Characteristics	81
36.12	Power-on Reset Characteristics	81
36.13	Flash and EEPROM Memory Characteristics	82
36.14	Clock and Oscillator Characteristics	82
36.15	SPI characteristics	88
36.16	Two-Wire Interface Characteristics	90
37.	Typical Characteristics	92
37.1	Current consumption.	92
37.2	I/O Pin Characteristics	97
37.3	ADC Characteristics	103
37.4	Analog Comparator Characteristics	110
37.5	Internal 1.0V reference Characteristics.	114
37.6	BOD Characteristics	114
37.7	External Reset Characteristics	117
37.8	Oscillator Characteristics	120
37.9	PDI characteristics	129
37.10	LCD Characteristics	130
38.	Errata	134
38.1	ATxmega64B1, ATxmega128B1	134
39.	Datasheet Revision History	135
39.1	8330F – 02/2014.	135
39.2	8330E – 06/2013.	135
39.3	8330D – 01/2013	135
39.4	8330C – 07/2012	135
39.5	8330B – 02/2012.	136
39.6	8330A – 10/2011.	136
	Table Of Contents.	i



Atmel®, Atmel logo and combinations thereof, and others are registered trademarks or trademarks of Atmel Corporation or its subsidiaries. Other terms and product names may be trademarks of others.

DISCLAIMER: The information in this document is provided in connection with Atmel products. No license, express or implied, by estoppel or otherwise, to any intellectual property right is granted by this document or in connection with the sale of Atmel products. EXCEPT AS SET FORTH IN THE ATMEL TERMS AND CONDITIONS OF SALES LOCATED ON THE ATMEL WEBSITE, ATMEL ASSUMES NO LIABILITY WHATSOEVER AND DISCLAIMS ANY EXPRESS, IMPLIED OR STATUTORY WARRANTY RELATING TO ITS PRODUCTS INCLUDING, BUT NOT LIMITED TO, THE IMPLIED WARRANTY OF MERCHANTABILITY, FITNESS FOR A PARTICULAR PURPOSE, OR NON-INFRINGEMENT. IN NO EVENT SHALL ATMEL BE LIABLE FOR ANY DIRECT, INDIRECT, CONSEQUENTIAL, PUNITIVE, SPECIAL OR INCIDENTAL DAMAGES (INCLUDING, WITHOUT LIMITATION, DAMAGES FOR LOSS AND PROFITS, BUSINESS INTERRUPTION, OR LOSS OF INFORMATION) ARISING OUT OF THE USE OR INABILITY TO USE THIS DOCUMENT, EVEN IF ATMEL HAS BEEN ADVISED OF THE POSSIBILITY OF SUCH DAMAGES. Atmel makes no representations or warranties with respect to the accuracy or completeness of the contents of this document and reserves the right to make changes to specifications and products descriptions at any time without notice. Atmel does not make any commitment to update the information contained herein. Unless specifically provided otherwise, Atmel products are not suitable for, and shall not be used in, automotive applications. Atmel products are not intended, authorized, or warranted for use as components in applications intended to support or sustain life.

SAFETY-CRITICAL, MILITARY, AND AUTOMOTIVE APPLICATIONS DISCLAIMER: Atmel products are not designed for and will not be used in connection with any applications where the failure of such products would reasonably be expected to result in significant personal injury or death ("Safety-Critical Applications") without an Atmel officer's specific written consent. Safety-Critical Applications include, without limitation, life support devices and systems, equipment or systems for the operation of nuclear facilities and weapons systems. Atmel products are not designed nor intended for use in military or aerospace applications or environments unless specifically designated by Atmel as military-grade. Atmel products are not designed nor intended for use in automotive applications unless specifically designated by Atmel as automotive-grade.