

SECTION A-A  
(VIEW FROM FRONT)

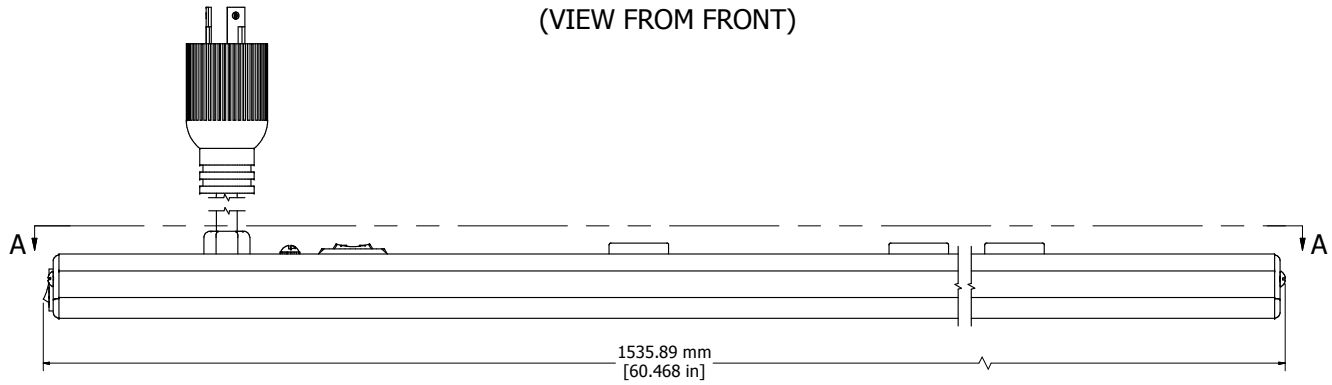

ASSEMBLY - VIEW FROM SIDE

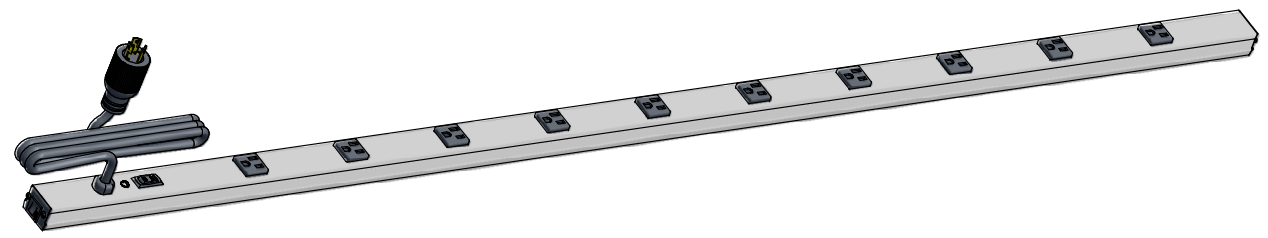

ISOMETRIC VIEW

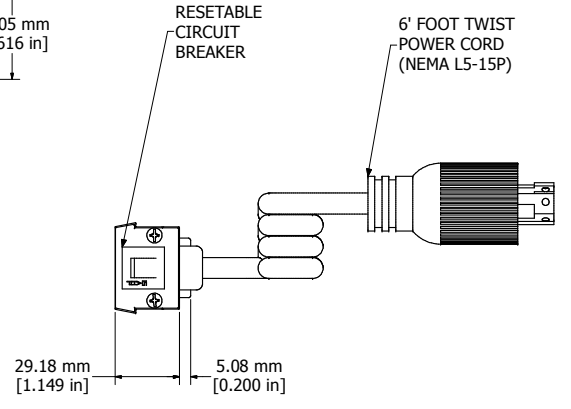

ASSEMBLY - VIEW FROM END

<b>1586H10C1</b>
Finish - Case - Anodized Aluminum Extrusion
Ends - ABS Plastic
Rated - 125 VAC, 60 Hz, 15 Amps
Approvals - CSA Certified Standards C22.2 (No. 21-95, 42-99) - UL Listed Standard UL1363
<b>Cord Length</b>
1586H10C1 - 6' Foot Twist Power Cord (NEMA L5-15P)
1586H10D1 - 15' Foot Twist Power Cord (NEMA L5-15P)
<b>Accessories Included</b>
Mounting Bracket Kit with Hardware

**HAMMOND MANUFACTURING™**

**1586H10C1**

www.hammondmfg.com