

## 3rd. Over Tone Small Sized Quartz Crystal Oscillator

### ■GENERAL DESCRIPTION

The NJU6376 series is a C-MOS 3rd. over tone quartz crystal oscillator that consists of an oscillation amplifier and 3-state output buffer.

The type numbers are classed into four versions G, H, J and K according to their oscillation frequency range shown in the line-up table.

The oscillation amplifier is realized very low stand-by current using NAND circuit.

The 3-state output buffer is C-MOS compatible

Furthermore, the package is small-sized MTP-6.

### ■PACKAGE OUTLINE



NJU6376XC-C    NJU6376XF1

### ■FEATURES

- Operating Voltage                                2.2 to 5.5V
- Oscillation Frequency Range                (See Line-up Table)
- Low Operating Current
- High Fan-out                                       $I_{OH}/I_{OL}=4mA @2.5V$
- Oscillation Stop and Output Stand-by Function
- 3-State Output Buffer
- Oscillation Capacitors  $C_g$  and  $C_d$  on-chip
- Package Outline                                 Chip/MTP-6
- C-MOS Technology

### ■PAD LOCATION/PIN CONFIGURATION

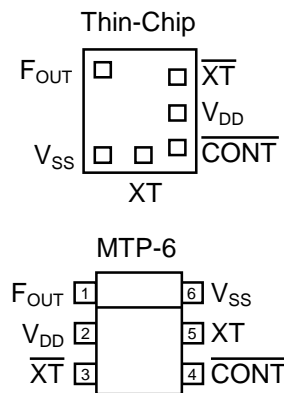

### ■LINE-UP TABLE

Type No.	Recommended Oscillation Frequency Range	Output Frequency	Cg/Cd
NJU6376	G    30 to 40MHz	$f_0$	18/18pF
	H    40 to 50MHz		16/16pF
	J    50 to 60MHz		11/11pF
	K    60 to 75MHz		10/10pF

### ■COORDINATION

Pad Name	X	Y
F <sub>OUT</sub>	-220	245
V <sub>SS</sub>	-205	-230
XT	13	-230
CONT	205	-191
V <sub>DD</sub>	205	0
$\overline{XT}$	205	191

Starting Point: Chip Center Unit[ $\mu m$ ]  
 Chip Size: 0.70x0.75mm  
 Thin-Chip Thickness(-C): 260 $\pm$ 20 $\mu m$   
 Pad Size: 90x90 $\mu m$

### ■BLOCK DIAGRAM

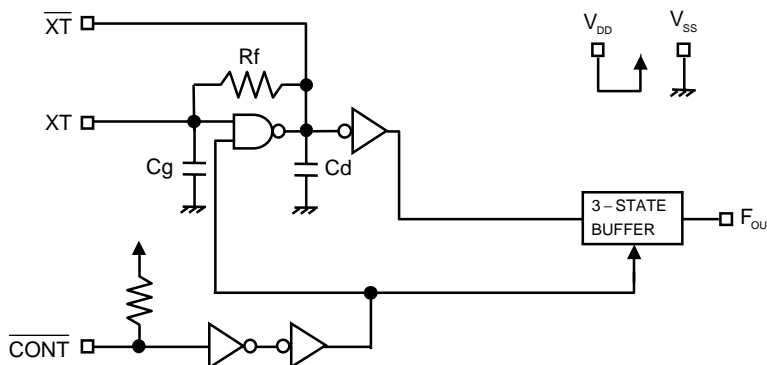

## ■TERMINAL DESCRIPTION

SYMBOL	FUNCTION	
$\overline{\text{CONT}}$	Oscillation and 3-state Output Buffer Control	
	$\overline{\text{CONT}}$	$F_{\text{OUT}}$
	H or OPEN	Output frequency $f_0$ (Note1)
	L	Oscillation Stop and High impedance Output
$\overline{\text{XT}}$ $\overline{\text{XT}}$	Quartz Crystal Connecting Terminals	
$V_{\text{SS}}$	$V_{\text{SS}}=0\text{V}$	
$F_{\text{OUT}}$	Frequency Output	
$V_{\text{DD}}$	$V_{\text{DD}}=2.5\text{V}/3.0\text{V}/5.0\text{V}$	

Note1) Refer to the line-up table.

## ■ABSOLUTE MAXIMUM RATINGS

( $T_a=25^\circ\text{C}$ )

PARAMETER	SYMBOL	RATING	UNIT
Supply Voltage	$V_{\text{DD}}$	-0.5 to +7.0	V
Input Voltage	$V_{\text{IN}}$	$V_{\text{SS}}-0.5$ to $V_{\text{DD}}+0.5$	V
Output Voltage	$V_{\text{O}}$	-0.5 to $V_{\text{DD}}+0.5$	V
Input Current	$I_{\text{IN}}$	$\pm 10$	mA
Output Current	$I_{\text{O}}$	$\pm 25$	mA
Power Dissipation Note4)	$P_{\text{D}}$	200(MTP-6)	mW
Operating Temperature Range	$T_{\text{opr}}$	-40 to +85	$^\circ\text{C}$
Storage Temperature Range	$T_{\text{stg}}$	-55 to +125	$^\circ\text{C}$

Note2) If the supply voltage( $V_{\text{DD}}$ ) is less than 7.0V, the input voltage must not over the  $V_{\text{DD}}$  level though 7.0V is limit specified.

Note3) Decoupling capacitor should be connected between  $V_{\text{DD}}$  and  $V_{\text{SS}}$  due to the stabilized operation for the circuit.

Note4) The power dissipation is the maximum value at only the package.

## ■ ELECTRICAL CHARACTERISTICS

(Ta=25°C)

PARAMETER	SYMBOL	CONDITIONS	MIN	TYP	MAX	UNIT
Operating Voltage	V <sub>DD</sub>		2.2		5.5	V

(V<sub>DD</sub>=2.5V, Ta=25°C)

PARAMETER	SYMBOL	CONDITIONS	MIN	TYP	MAX	UNIT
Operating Current	I <sub>DD</sub>	G version, fosc=40MHz, C <sub>L</sub> =15pF			6	mA
		H version, fosc=50MHz, C <sub>L</sub> =15pF			9	
		J version, fosc=60MHz, C <sub>L</sub> =15pF			9	
		K version, fosc=75MHz, C <sub>L</sub> =15pF			10	
Oscillation Stopping Current	I <sub>STB</sub>	$\overline{\text{CONT}} = V_{SS}$ , No load		2	5	uA
Stand-by Current	I <sub>st</sub>	$\overline{\text{CONT}} = \text{XT} = V_{SS}$ , No load Note5)			1	uA
Input Voltage	V <sub>IH</sub>		2.0		2.5	V
	V <sub>IL</sub>		0		0.5	V
Output Current	I <sub>OH</sub>	V <sub>OH</sub> =2.2V	4			mA
	I <sub>OL</sub>	V <sub>OL</sub> =0.3V	4			mA
Input Current	I <sub>IN</sub>	$\overline{\text{CONT}} = 0.8V_{DD}$		7.5	12.0	uA
		$\overline{\text{CONT}} = 0.2V_{DD}$		1.2	2.0	uA
3-state Off Leakage Current	I <sub>OZ</sub>	$\overline{\text{CONT}} = V_{SS}$ , F <sub>OUT</sub> = V <sub>DD</sub> or V <sub>SS</sub>			±0.1	uA
Feedback Resistance	R <sub>f</sub>	G version		4.5		KΩ
		H version		3.1		
		J version		3.9		
		K version		3.1		
Internal Capacitor	C <sub>g</sub> /C <sub>d</sub>	G version, fosc=40MHz		18/18		pF
		H version, fosc=50MHz		16/16		
		J version, fosc=60MHz		11/11		
		K version, fosc=75MHz		10/10		
Maximum Oscillation Frequency	F <sub>MAX</sub>	G version	40			MHz
		H version	50			
		J version	60			
		K version	75			
Output Signal Symmetry	SYM	C <sub>L</sub> =15pF, @V <sub>DD</sub> /2	45	50	55	%
Output Signal Rise Time	t <sub>r</sub>	C <sub>L</sub> =15pF, 10% to 90%		3	6	ns
Output Signal Fall Time	t <sub>f</sub>	C <sub>L</sub> =15pF, 90% to 10%		3	6	ns
Output Disable time	T <sub>PLZ</sub>	C <sub>L</sub> =15pF, R <sub>UP</sub> =10kΩ			200	ns
Output Enable Time	T <sub>PZL</sub>	C <sub>L</sub> =15pF, R <sub>UP</sub> =10kΩ			200	ns

Note5) Excluding input current on  $\overline{\text{CONT}}$  Terminal.

( $V_{DD}=3.0V, T_a=25^{\circ}C$ )

PARAMETER	SYMBOL	CONDITIONS	MIN	TYP	MAX	UNIT
Operating Current	$I_{DD}$	G version, $f_{osc}=40MHz, C_L=15pF$			8	mA
		H version, $f_{osc}=50MHz, C_L=15pF$			10	
		J version, $f_{osc}=60MHz, C_L=15pF$			11	
		K version, $f_{osc}=75MHz, C_L=15pF$			12	
Oscillation Stopping Current	$I_{STB}$	$\overline{CONT} = V_{SS}$ , No load		2	5	uA
Stand-by Current	$I_{st}$	$\overline{CONT} = XT = V_{SS}$ , No load Note5)			1	uA
Input Voltage	$V_{IH}$		2.1		3.0	V
	$V_{IL}$		0		0.9	V
Output Current	$I_{OH}$	$V_{OH}=2.7V$	5			mA
	$I_{OL}$	$V_{OL}=0.3V$	5			mA
Input Current	$I_{IN}$	$\overline{CONT} = 0.8V_{DD}$		10.0	15.0	uA
		$\overline{CONT} = 0.2V_{DD}$		1.8	3.0	uA
3-state Off Leakage Current	$I_{OZ}$	$\overline{CONT} = V_{SS}$ , $F_{OUT} = V_{DD}$ or $V_{SS}$			$\pm 0.1$	uA
Feedback Resistance	$R_f$	G version		4.5		K $\Omega$
		H version		3.1		
		J version		3.9		
		K version		3.1		
Internal Capacitor	$C_g/C_d$	G version, $f_{osc}=40MHz$		18/18		pF
		H version, $f_{osc}=50MHz$		16/16		
		J version, $f_{osc}=60MHz$		11/11		
		K version, $f_{osc}=75MHz$		10/10		
Maximum Oscillation Frequency	$F_{MAX}$	G version	40			MHz
		H version	50			
		J version	60			
		K version	75			
Output Signal Symmetry	SYM	$C_L=15pF, @V_{DD}/2$	45	50	55	%
Output Signal Rise Time	$t_r$	$C_L=15pF, 10\% \sim 90\%$		2.5	5	ns
Output Signal Fall Time	$t_f$	$C_L=15pF, 90\% \sim 10\%$		2.5	5	ns
Output Disable time	$T_{PLZ}$	$C_L=15pF, R_{UP}=10k\Omega$			150	ns
Output Enable Time	$T_{PZL}$	$C_L=15pF, R_{UP}=10k\Omega$			150	ns

Note5) Excluding input current on  $\overline{CONT}$  Terminal.

( $V_{DD}=5.0V, T_a=25^{\circ}C$ )

PARAMETER	SYMBOL	CONDITIONS	MIN	TYP	MAX	UNIT
Operating Current	$I_{DD}$	G version, $f_{osc}=40MHz, C_L=15pF$			22	mA
		H version, $f_{osc}=50MHz, C_L=15pF$			25	
		J version, $f_{osc}=60MHz, C_L=15pF$			32	
		K version, $f_{osc}=75MHz, C_L=15pF$			34	
Oscillation Stopping Current	$I_{STB}$	$\overline{CONT} = V_{SS}$ , No load		5	10	uA
Stand-by Current	$I_{st}$	$\overline{CONT} = XT = V_{SS}$ , No load Note5)			1	uA
Input Voltage	$V_{IH}$		3.5		5.0	V
	$V_{IL}$		0		1.5	V
Output Current	$I_{OH}$	$V_{OH}=4.5V$	8			mA
	$I_{OL}$	$V_{OL}=0.5V$	8			mA
Input Current	$I_{IN}$	$\overline{CONT} = 0.8V_{DD}$		27.0	40.0	uA
		$\overline{CONT} = 0.2V_{DD}$		5.5	8.0	uA
3-state Off Leakage Current	$I_{OZ}$	$\overline{CONT} = V_{SS}$ , $F_{OUT} = V_{DD}$ or $V_{SS}$			$\pm 0.1$	uA
Feedback Resistance	$R_f$	G version		4.5		K $\Omega$
		H version		3.1		
		J version		3.9		
		K version		3.1		
Internal Capacitor	$C_g/C_d$	G version, $f_{osc}=40MHz$		18/18		pF
		H version, $f_{osc}=50MHz$		16/16		
		J version, $f_{osc}=60MHz$		11/11		
		K version, $f_{osc}=75MHz$		10/10		
Maximum Oscillation Frequency	$F_{MAX}$	G version	40			MHz
		H version	50			
		J version	60			
		K version	75			
Output Signal Symmetry	SYM	$C_L=15pF, @V_{DD}/2$	45	50	55	%
Output Signal Rise Time	$t_r$	$C_L=15pF, 10\% \sim 90\%$		2	4	ns
Output Signal Fall Time	$t_f$	$C_L=15pF, 90\% \sim 10\%$		2	4	ns
Output Disable time	$T_{PLZ}$	$C_L=15pF, R_{UP}=10k\Omega$			100	ns
Output Enable Time	$T_{PZL}$	$C_L=15pF, R_{UP}=10k\Omega$			100	ns

Note5) Excluding input current on  $\overline{CONT}$  Terminal.

## MEASUREMENT CIRCUITS

### (1) Output Signal Symmetry ( $C_L=15\text{pF}$ )

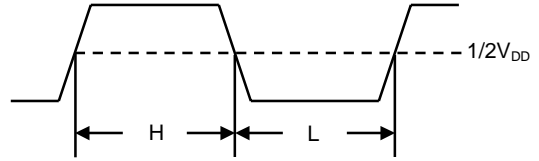
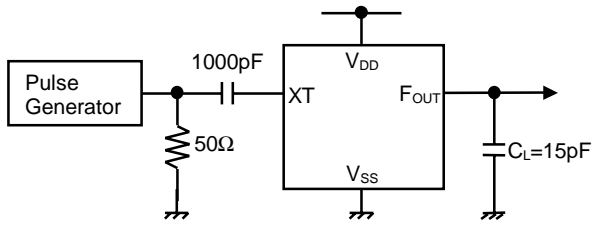

### (2) Output Signal Rise/Fall Time ( $C_L=15\text{pF}$ )

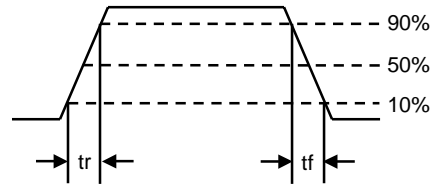
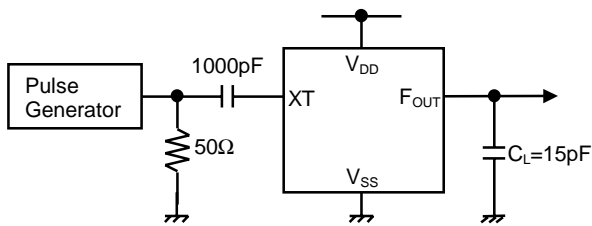

### (3) Output Disable/Enable Time ( $C_L=15\text{pF}, R_{UP}=10\text{k}\Omega$ )

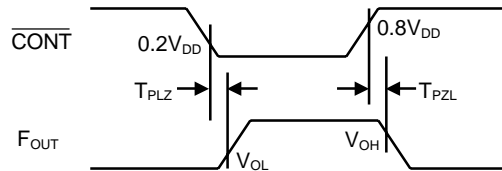
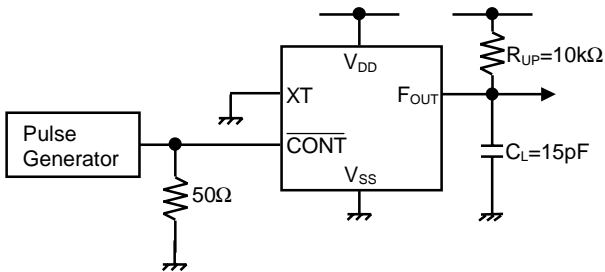

**[CAUTION]**  
 The specifications on this data book are only given for information, without any guarantee as regards either mistakes or omissions. The application circuits in this data book are described only to show representative usages of the product and not intended for the guarantee or permission of any right including the industrial rights.