



M20-284296-32

2" Square / 50.8mm Square Waffle Tray (BLACK)

Features:

- Static Protective
- Tight Dimensional Pocket Tolerance
- Durable Material Construction

Component Applications:

- Thin Film & Chip Level / Known Good Die (KGD)
- Passive and Active Chip Components
- Opto Electronics and Mechanical Components

Waffle Tray Diagram

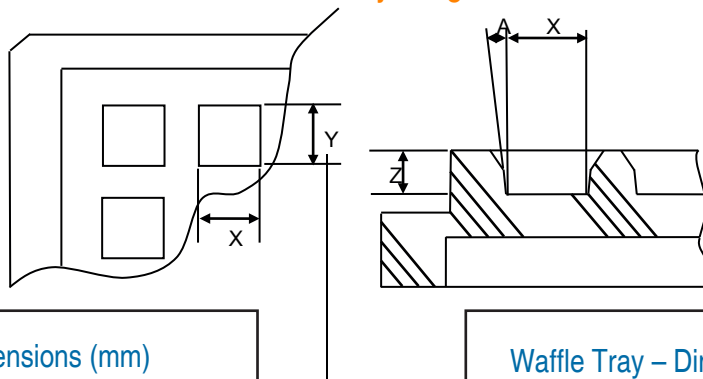

Waffle Tray - Dimensions (mm)

Technical Spec (mm)

X = 7.49mm ±0.13mm pocket size
 Y = 7.19mm ±0.13mm pocket size
 Z = 0.81mm ±0.08mm pocket depth
 A = 5° ±1/2° pocket draft angle
 No Cross Slots
 Array = 5 X 5 (25)

Overall Tray Size:

Size = 50.67mm ±0.25mm
 Height = 3.94mm +0.08mm -0.13mm
 Flatness = 0.30mm

Waffle Tray – Dimensions (Inches)

Technical Spec (inches)

X = 0.295" ±0.005" pocket size
 Y = 0.283" ±0.005" pocket size
 Z = 0.032" ±0.003" pocket depth
 A = 5° ±1/2° pocket draft angle
 No Cross Slots
 Array = 5 X 5 (25)

Overall Tray Size:

Size = 1.995" ±0.010"
 Height = 0.155" +0.003" -0.005"
 Flatness = 0.012"

Buy M20-284296-32 Waffle Tray Pack Online

Micross Kit Includes – Tray, Lid, Tyvek Paper and Clip

| | |
|--------------------------|---|
| Tray Material | Polypropylene with Carbon Powder and Glass Bead |
| Surface Resistivity | 10 ¹ - 10 ⁵ |
| Static Delay Time (sec.) | <0.01 |
| Temperature Limit | 70°C |
| Lid Material | Polypropylene with Carbon Powder and Glass Bead |
| Clip Material | Polypropylene with Carbon Powder |