



### SOT-26



### Pin Definition:

1. Switch
2. Ground
3. Feedback
4. Enable
5. OVP
6. V<sub>CC</sub>

## General Description

The TS1916 is a step-up (Boost) converter designed for driving up to 10 series white LEDs for backlighting application. The TS1916 uses current mode, 1MHz fixed frequency architecture to regulate the LED current, which is set through an external current sense resistor. It's low feedback voltage reduces power loss and improves efficiency. The OVP pin monitors the output voltage and turns off the converter if an over-voltage condition is present due to an open circuit condition. The TS1916 includes under-voltage lockout, current limiting and thermal shutdown protection preventing damage in the event of an output overload.

## Features

- 2.5V to 5.5V operating input voltage range
- Drives up to 10 series white LEDs
- 1MHz fixed switching frequency
- Wide range for PWM dimming (200Hz to 200kHz)
- Internal 1.7A switching current limit
- Over voltage protection (OVP)
- Internal soft-start function
- Current limit and thermal shutdown protection
- Under voltage lockout

## Application

- Digital Still Cameras
- Portable Electronics
- PDAs and Palm-Top Computers
- Local Boost Regulator

## Ordering Information

Part No.	Package	Packing
TS1916CX6 RFG	SOT-26	3kpcs / 7" Reel

**Note:** "G" denotes for Halogen- and Antimony-free as those which contain <900ppm bromine, <900ppm chlorine (<1500ppm total Br + Cl) and <1000ppm antimony compounds

## Absolute Maximum Ratings

Parameter	Symbol	Limit	Unit
V <sub>CC</sub> Pin Voltage	V <sub>CC</sub>	-0.3 to 6	V
SW Pin Voltage	V <sub>SW</sub>	-0.3 to 45	V
OVP Pin Voltage	V <sub>OVP</sub>	-0.3 to 45	V
EN, FB Pin Voltage		-0.3 to 6	V
Power Dissipation	P <sub>D</sub>	(T <sub>J</sub> -T <sub>A</sub> ) / R <sub>θJA</sub>	mW
Storage Temperature Range	T <sub>STG</sub>	-65 to +150	°C
Operating Junction Temperature Range	T <sub>OP</sub>	-40 to +125	°C
Thermal Resistance from junction to case	R <sub>θJC</sub>	15	°C/W
Thermal Resistance from junction to ambient	R <sub>θJA</sub>	40	°C/W

**Note:** R<sub>θJA</sub> is measured with the PCB copper area of approximately 1 in<sup>2</sup> (Multi-layer).

**Electrical Specifications** ( $T_A=25^{\circ}\text{C}$ ,  $V_{IN}=5\text{V}$ ,  $I_{OUT}=20\text{mA}$  unless otherwise noted)

Characteristics		Symbol	Conditions	Min	Typ	Max	Units
Input Voltage Range		$V_{CC}$		2.5	--	5.5	V
Step-Up Voltage Range		$V_{OUT}$		3	--	40	V
OVP Sense Voltage		$V_{OVP}$		--	38	--	V
Under Voltage Lockout		$U_{VLO}$	Rising	--	2.2	2.4	V
UVLO Hysteresis				--	100	--	mV
Feedback Voltage		$V_{FB}$		190	200	210	mV
EN Threshold	Logic-High Voltage	$V_{IH}$		2.0	--	--	V
	Logic-Low Voltage	$V_{IL}$		--	--	0.4	V
EN Hysteresis				--	200	--	mV
Operating Quiescent Current		$I_{CCQ}$	$I_{OUT}=0\text{mA}$ , $V_{FB}=0.5\text{V}$	--	300	500	$\mu\text{A}$
Shutdown Current		$I_{SD}$	$V_{EN}=0\text{V}$ , $t_{EN} > 20\text{ms}$	--	1	10	$\mu\text{A}$
N-Channel MOSFET Current Limit <sup>(Note)</sup>		$I_{LIM}$	Duty=50%	--	1.7	--	A
MOSFET On-Resistance <sup>(Note)</sup>		$R_{DS(on)}$		--	0.6	1.0	$\Omega$
Maximum Duty Cycle		$D_{MAX}$		--	88	--	%
Line Regulation			$V_{CC} = 3\text{V to } 5\text{V}$	--	1	--	%
Switching Frequency		$f_{OSC}$		0.75	1	1.25	MHz
Dimming Clock Rate		$f_{DIM}$		0.2	--	200	kHz
FB Input Leakage Current		$I_{FB-LKG}$	$V_{FB} = 0.5\text{V}$	--	0.01	100	nA
SW Leakage Current		$I_{SWL}$	$V_{LX} = 30\text{V}$ , $V_{FB}=0.5\text{V}$	--	--	1	$\mu\text{A}$
EN Input Leakage Current		$I_{EN-LKG1}$	$V_{EN}=V_{CC}$	--	1.5	3	$\mu\text{A}$
		$I_{EN-LKG2}$	$V_{EN}=GND$	--	--	1	$\mu\text{A}$
Shutdown Delay		$t_{SHDN}$		--	10	--	ms
Thermal Shutdown		$T_{SD}$		--	160	--	$^{\circ}\text{C}$
Thermal Shutdown Hysteresis		$T_{SH}$		--	30	--	

**Note:** Guaranteed by design



**Block Diagram**

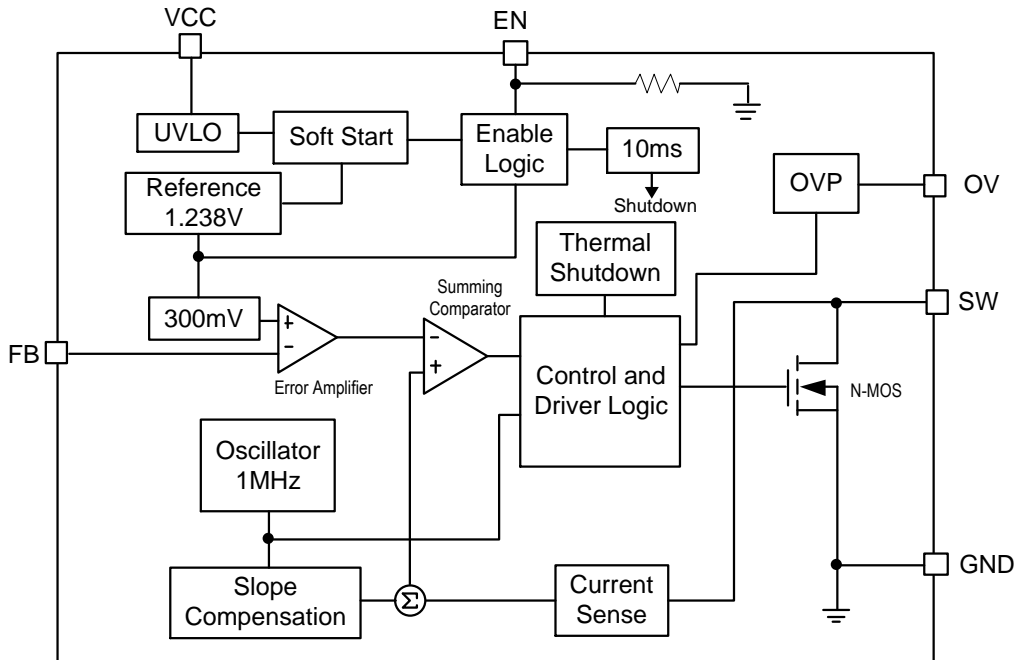

**Pin Description**

Pin Number	Pin Name	Description
1	SW	Switch Output Pin
2	GND	Ground Pin
3	FB	Feedback Pin; Put a Resistor to GND to Setting the Current
4	EN	Enable with Dimming Pin; Internal Pull-Low; Logic High Active
5	OVP	OVP Sense Pin
6	V <sub>CC</sub>	Power Input Pin

### Application Circuit

#### For 10 series LED Application with Dimming

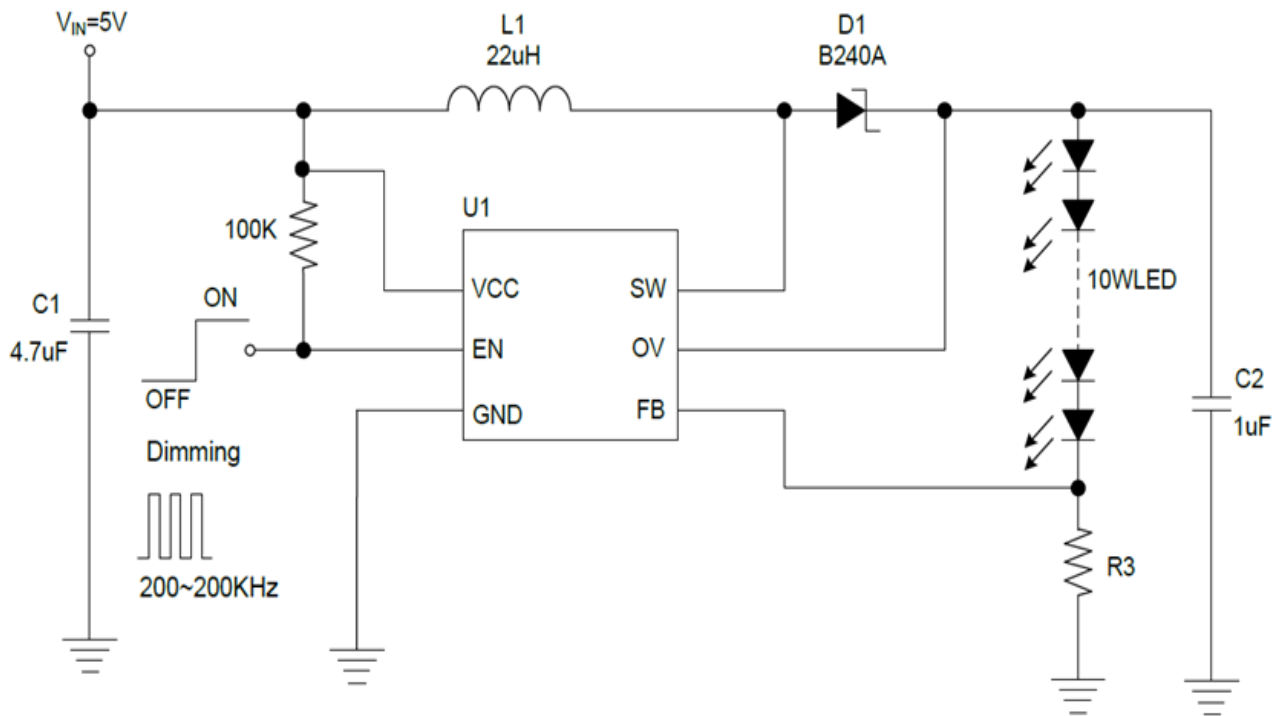

$$I_{LED} = V_{FB} / R3, V_{FB} = 200mV$$

### Application Information

#### Setting the ILED Current

Application circuit item shows the basic application circuit with TS1916 adjustable output version. The external resistor sets the LED output current according to the following equation:

$$I_{LED} = (V_{FB} / R3)$$

Part No.	I <sub>LED</sub>	R3	
TS1916	20mA	10Ω	4mW
	350mA	0.571Ω	70mW

#### Over Voltage Protection

The Over Voltage Protection is detected by a junction breakdown detecting circuit. Once V<sub>OUT</sub> goes over the detecting voltage, SW pin stops switching and the power N-MOSFET will be turned off. Then, the V<sub>OUT</sub> will be clamped to be near V<sub>OVp</sub>.

#### Under Voltage Lockout (UVLO)

To avoid mis-operation of the device at low input voltages an under voltage lockout is included that disables the device, if the input voltage falls below (2.25V-100mV).

#### Input Capacitor Selection

The input capacitor reduces the surge current drawn from the input and switching noise from the device. The input capacitor impedance at the switching frequency shall be less than input source impedance to prevent high frequency switching current passing to the input. A low ESR input capacitor sized for maximum RMS current must be used. Ceramic capacitors with X5R or X7R dielectrics are highly recommended because of their low ESR and small temperature coefficients. A 4.7μF ceramic capacitor for most applications is sufficient. For a lower output power requirement application, this value can be decreased.

#### Output Capacitor Selection

The output capacitor is required to keep the output voltage ripple small and to ensure regulation loop stability. The output capacitor must have low impedance at the switching frequency. Ceramic capacitors with X5R or X7R dielectrics are recommended due to their low ESR and high ripple current. A 1μF ceramic capacitors works for most of the applications. Higher capacitor values can be used to improve the load transient response.

### Electrical Characteristics Curve

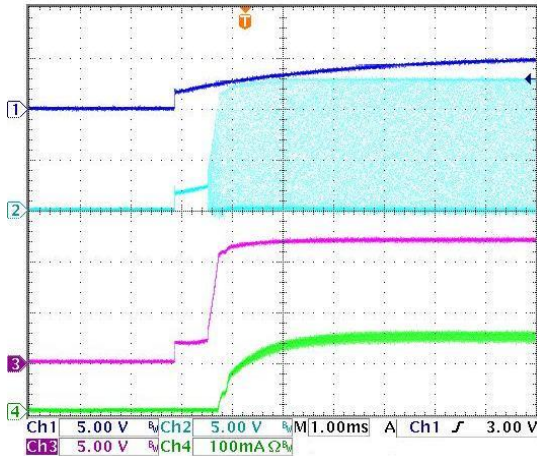

**Figure 1. Power On from  $V_{IN}$**

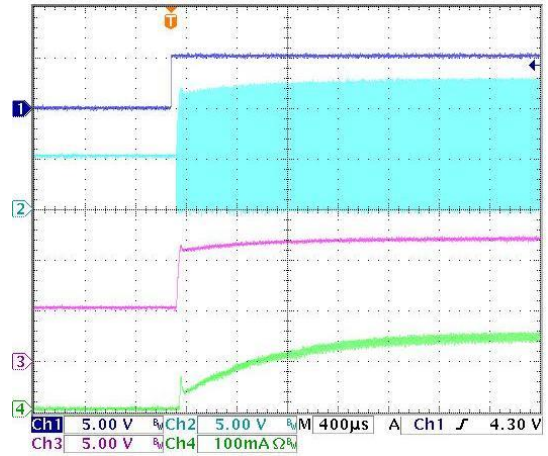

**Figure 2. Power On from EN**

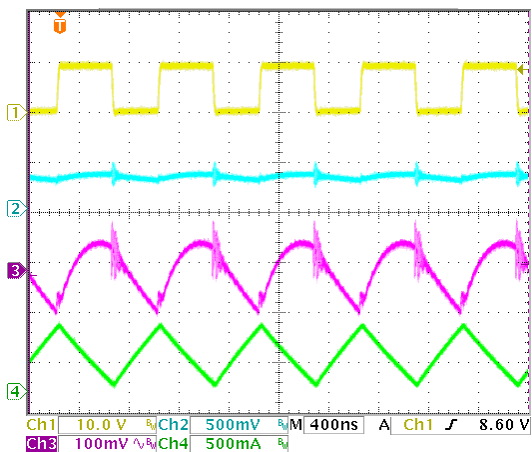

**Figure 3. Steady State Operation**

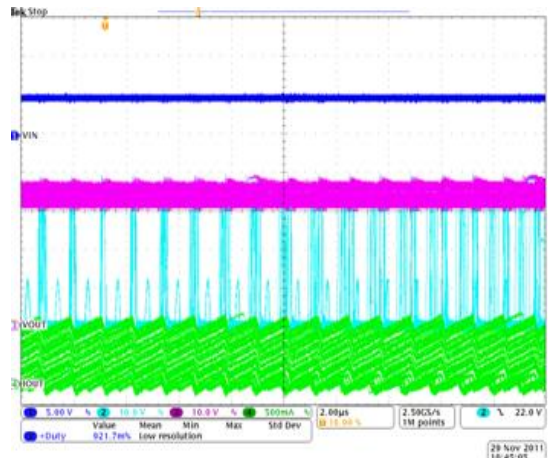

**Figure 4. Normal Operation Into OVP**

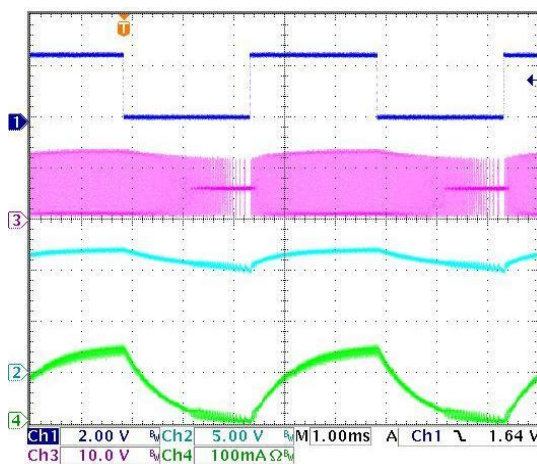

**Figure 5. PWM Dimming From EN (200Hz)**  
 $V_{IN}=5V$ , 4WLEDs,  $I_{OUT}=150mA$

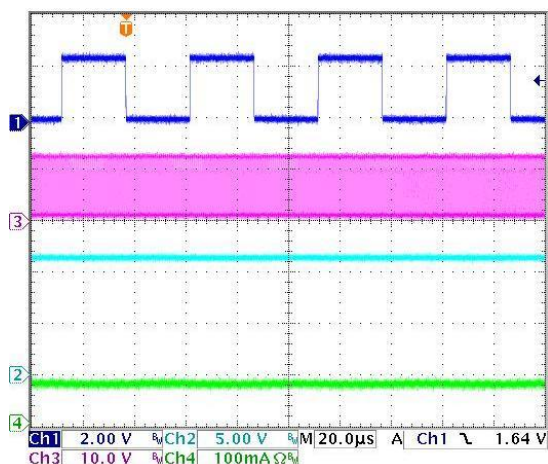

**Figure 6. PWM Dimming From EN (20Hz)**  
 $V_{IN}=5V$ , 4WLEDs,  $I_{OUT}=150mA$

### Electrical Characteristics Curve

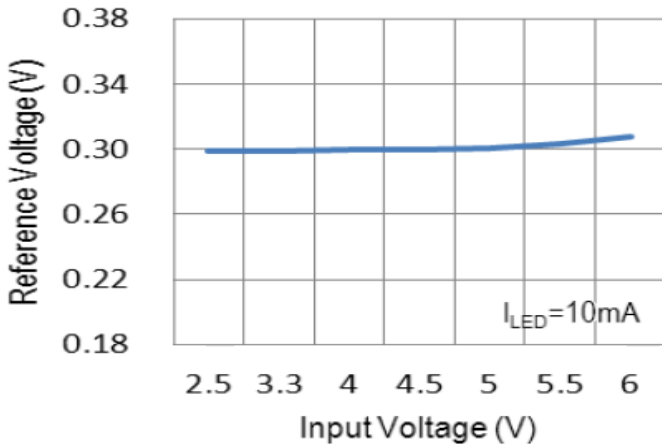

Figure 7. Reference Voltage vs. Input Voltage

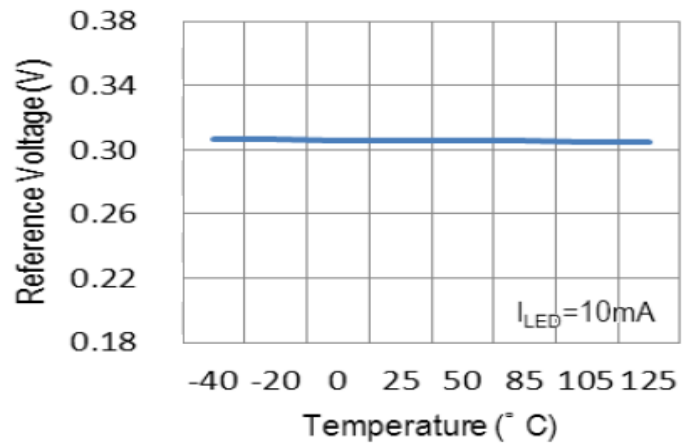

Figure 8. Reference Voltage vs. Temperature

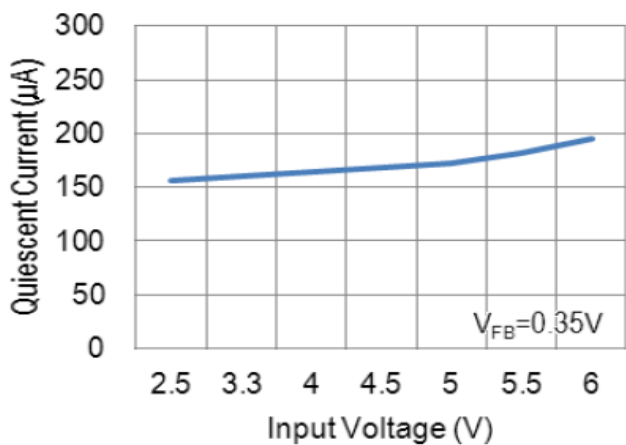

Figure 9. Quiescent Current vs. Input Voltage

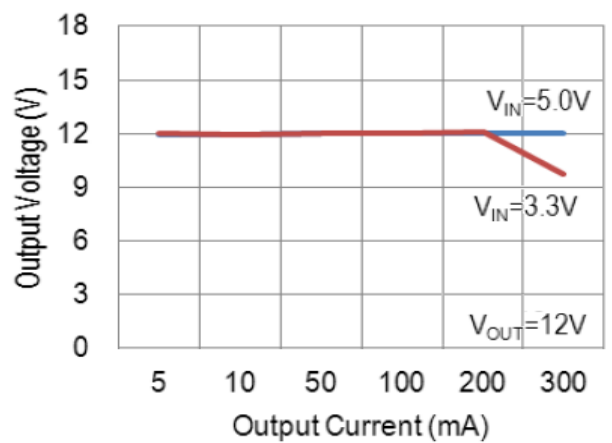

Figure 10. Output Voltage vs. Output Current

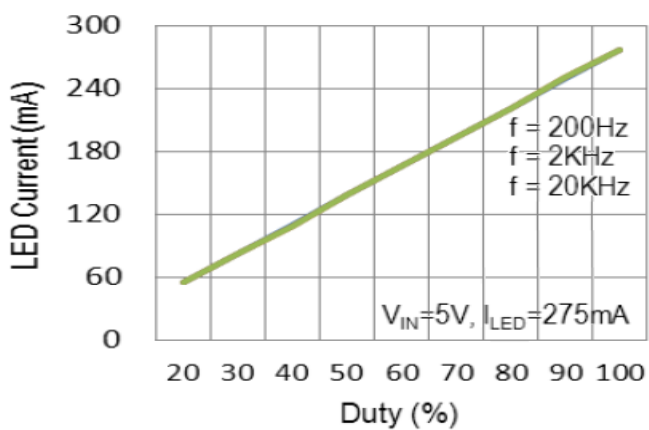

Figure 11. LED Current vs. Duty

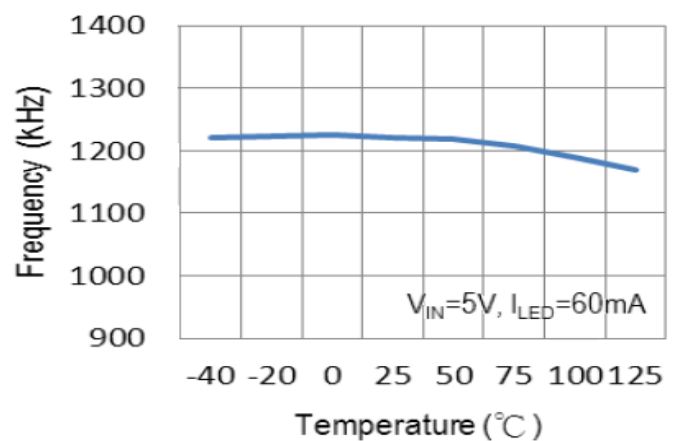

Figure 12. Frequency vs. Temperature



### Electrical Characteristics Curve

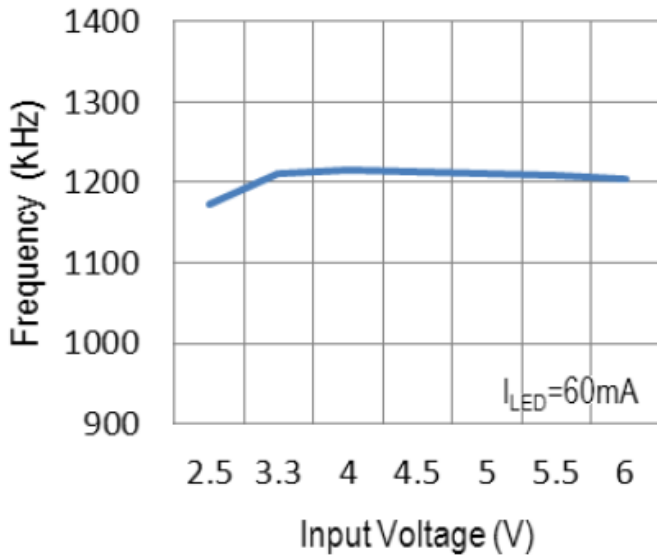

Figure 13. Frequency vs. Input Voltage

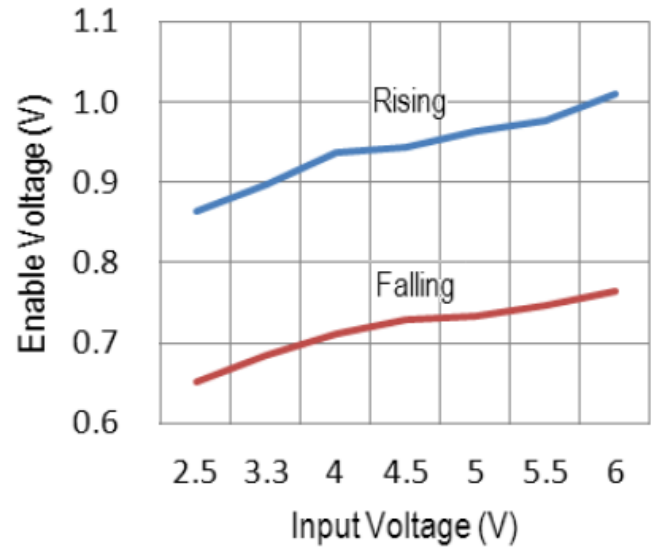

Figure 14. Enable Voltage vs. Input Voltage

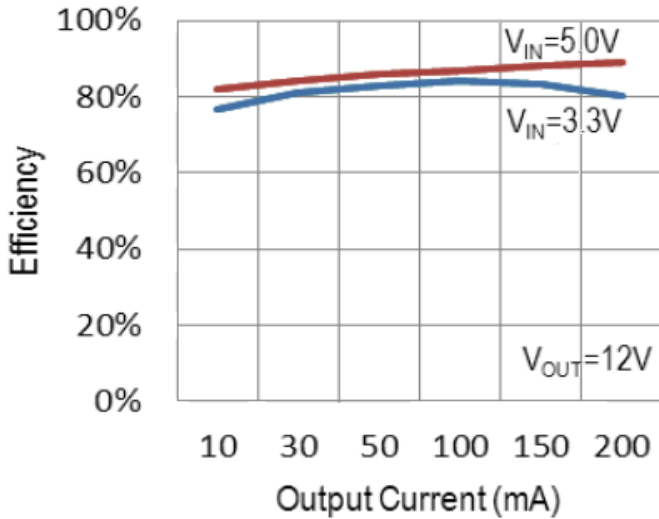

Figure 15. Efficiency vs. Output Current

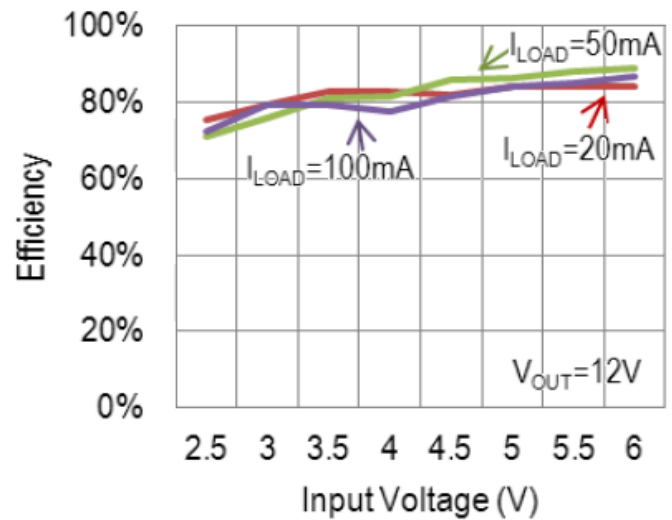
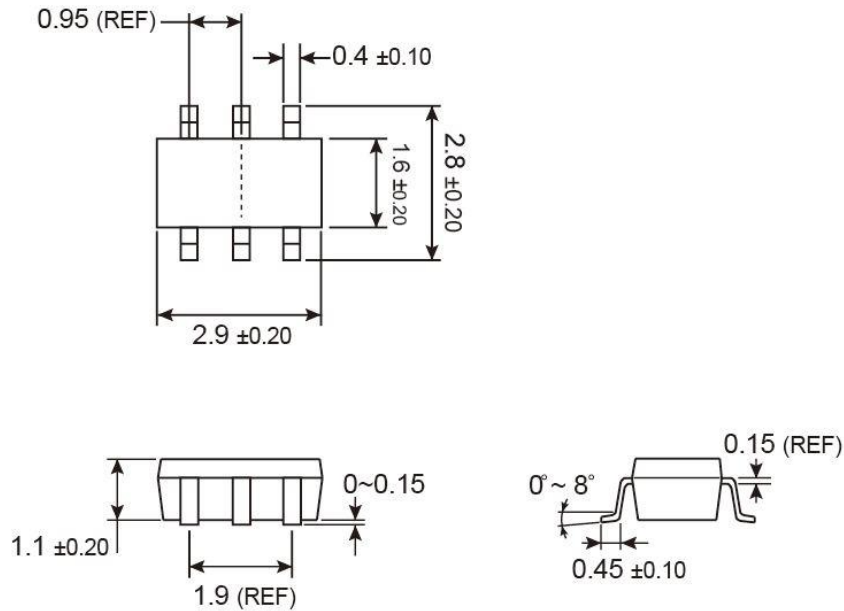

Figure 16. Efficiency vs. Input Voltage



**SOT-26 Mechanical Drawing**



Unit: Millimeters

**Marking Diagram**

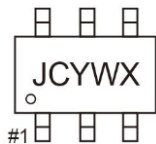

- JC** = Device Code
- Y** = Year Code  
(4=2014, 5=2015, 6=2016, 7=2017, 8=2018, 9=2019...)
- W** = Week: 01~26 (A~Z)  
27~52 (a~z)
- X** = Internal Code

### Notice

Specifications of the products displayed herein are subject to change without notice. TSC or anyone on its behalf, assumes no responsibility or liability for any errors or inaccuracies.

Information contained herein is intended to provide a product description only. No license, express or implied, to any intellectual property rights is granted by this document. Except as provided in TSC's terms and conditions of sale for such products, TSC assumes no liability whatsoever, and disclaims any express or implied warranty, relating to sale and/or use of TSC products including liability or warranties relating to fitness for a particular purpose, merchantability, or infringement of any patent, copyright, or other intellectual property right.

The products shown herein are not designed for use in medical, life-saving, or life-sustaining applications. Customers using or selling these products for use in such applications do so at their own risk and agree to fully indemnify TSC for any damages resulting from such improper use or sale.