

HEXFET® Power MOSFET

	N-CH	P-CH	
V_{DS}	30	-30	V
$R_{DS(on) max}$ (@ $V_{GS} = 10V$)	0.11	0.2	Ω
Q_g (typical)	7.8	7.5	nC
I_D (@ $T_A = 25^\circ C$)	2.7	-2.0	A

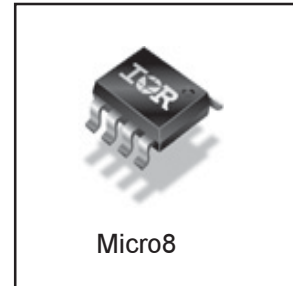
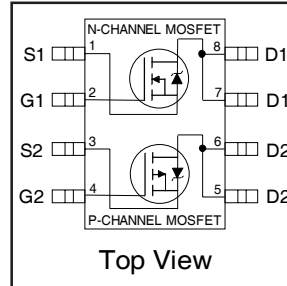

Features

Industry-standard pinout Micro-8 Package
Compatible with Existing Surface Mount Techniques
RoHS Compliant, Halogen-Free
MSL1, Industrial qualification



Benefits

Multi-Vendor Compatibility
Easier Manufacturing
Environmentally Friendlier
Increased Reliability

Base Part Number	Package Type	Standard Pack		Orderable Part Number
		Form	Quantity	
IRF7509PbF-1	Micro-8	Tube/Bulk	95	IRF7509PbF-1
		Tape and Reel	4000	IRF7509TRPbF-1

Absolute Maximum Ratings

	Parameter	Max.		Units
		N-Channel	P-Channel	
V_{DS}	Drain-Source Voltage	30	-30	V
$I_D @ T_A = 25^\circ C$	Continuous Drain Current, V_{GS}	2.7	-2.0	A
$I_D @ T_A = 70^\circ C$	Continuous Drain Current, V_{GS}	2.1	-1.6	
I_{DM}	Pulsed Drain Current ^①	21	-16	
$P_D @ T_A = 25^\circ C$	Maximum Power Dissipation ^④	1.25		W
$P_D @ T_A = 70^\circ C$	Maximum Power Dissipation ^④	0.8		W
	Linear Derating Factor	10		mW/°C
V_{GS}	Gate-to-Source Voltage	± 20		V
V_{GSM}	Gate-to-Source Voltage Single Pulse $t_p < 10\mu S$	30		V
dv/dt	Peak Diode Recovery dv/dt ^②	5.0		V/ns
T_J, T_{STG}	Junction and Storage Temperature Range	-55 to + 150		°C
	Soldering Temperature, for 10 seconds	240 (1.6mm from case)		

Thermal Resistance

	Parameter	Max.	Units
$R_{\theta JA}$	Maximum Junction-to-Ambient ^④	100	°C/W

Electrical Characteristics @ T_J = 25°C (unless otherwise specified)

Parameter	Parameter	Min.	Typ.	Max.	Units	Conditions
V _{(BR)DSS}	Drain-to-Source Breakdown Voltage	30	—	—	V	V _{GS} = 0V, I _D = 250μA V _{GS} = 0V, I _D = -250μA
ΔV _{(BR)DSS} /ΔT _J	Breakdown Voltage Temp. Coefficient	—	0.059	—	V/°C	Reference to 25°C, I _D = 1mA Reference to 25°C, I _D = -1mA
R _{DS(ON)}	Static Drain-to-Source On-Resistance	—	0.09	0.110	Ω	V _{GS} = 10V, I _D = 1.7A ③ V _{GS} = 4.5V, I _D = 0.85A ④ V _{GS} = -10V, I _D = -1.2A ④ V _{GS} = -4.5V, I _D = -0.6A ④
V _{GS(th)}	Gate Threshold Voltage	1.0	—	—	V	V _{DS} = V _{GS} , I _D = 250μA V _{DS} = V _{GS} , I _D = -250μA
g _{fs}	Forward Transconductance	1.9	—	—	S	V _{DS} = 10V, I _D = 0.85A ④ V _{DS} = -10V, I _D = -0.6A ④
I _{DSS}	Drain-to-Source Leakage Current	—	—	1.0	μA	V _{DS} = 24V, V _{GS} = 0V V _{DS} = -24V, V _{GS} = 0V V _{DS} = 24V, V _{GS} = 0V, T _J = 125°C V _{DS} = -24V, V _{GS} = 0V, T _J = 125°C
I _{GSS}	Gate-to-Source Forward Leakage	—	—	±100		V _{GS} = ± 20V
Q _g	Total Gate Charge	—	7.8	12		N-Channel I _D = 1.7A, V _{DS} = 24V, V _{GS} = 10V ④
Q _{gs}	Gate-to-Source Charge	—	1.2	1.8	nC	P-Channel I _D = -1.2A, V _{DS} = -24V, V _{GS} = -10V ④
Q _{gd}	Gate-to-Drain ("Miller") Charge	—	2.5	3.8		
t _{d(on)}	Turn-On Delay Time	—	4.7	—		N-Channel V _{DD} = 15V, I _D = 1.7A, R _G = 6.1Ω, R _D = 8.7Ω ④
t _r	Rise Time	—	10	—	ns	P-Channel V _{DD} = -15V, I _D = -1.2A, R _G = 6.2Ω, R _D = 12Ω ④
t _{d(off)}	Turn-Off Delay Time	—	12	—		
t _f	Fall Time	—	5.3	—		
C _{iss}	Input Capacitance	—	210	—	pF	N-Channel V _{GS} = 0V, V _{DS} = 25V, f = 1.0MHz ③
C _{oss}	Output Capacitance	—	80	—		P-Channel V _{GS} = 0V, V _{DS} = -25V, f = 1.0MHz ③
C _{rss}	Reverse Transfer Capacitance	—	32	—		

Source-Drain Ratings and Characteristics

Parameter	Parameter	Min.	Typ.	Max.	Units	Conditions
		N-Ch	P-Ch			
I _S	Continuous Source Current (Body Diode)	—	—	1.25	A	
I _{SM}	Pulsed Source Current (Body Diode) ①	—	—	-1.25		
V _{SD}	Diode Forward Voltage	—	—	1.2	V	T _J = 25°C, I _S = 1.7A, V _{GS} = 0V ③ T _J = 25°C, I _S = -1.8A, V _{GS} = 0V ③
t _{rr}	Reverse Recovery Time	—	40	60	ns	N-Channel T _J = 25°C, I _F = 1.7A, di/dt = 100A/μs ③
Q _{rr}	Reverse Recovery Charge	—	48	72	nC	P-Channel T _J = 25°C, I _F = -1.2A, di/dt = -100A/μs ③

Notes:

- ① Repetitive rating; pulse width limited by max. junction temperature. (See fig. 21)
- ② N-Channel I_{SD} ≤ 1.7A, di/dt ≤ 120A/μs, V_{DD} ≤ V_{(BR)DSS}, T_J ≤ 150°C
P-Channel I_{SD} ≤ -1.2A, di/dt ≤ 160A/μs, V_{DD} ≤ V_{(BR)DSS}, T_J ≤ 150°C
- ③ Pulse width ≤ 300μs; duty cycle ≤ 2%.
- ④ Surface mounted on FR-4 board, t ≤ 10sec.

N - Channel

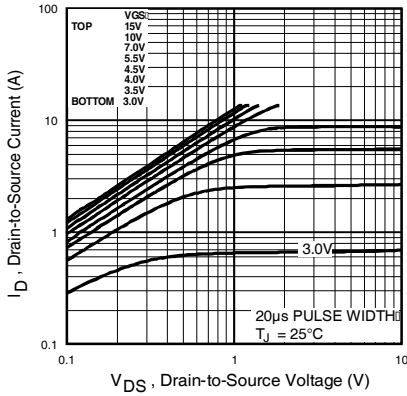
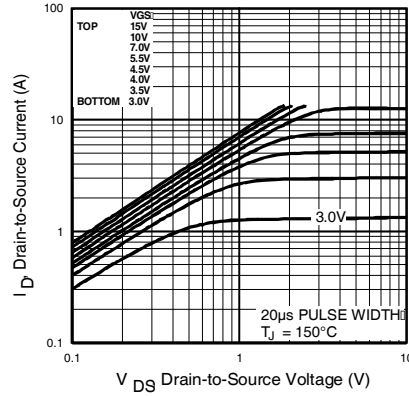
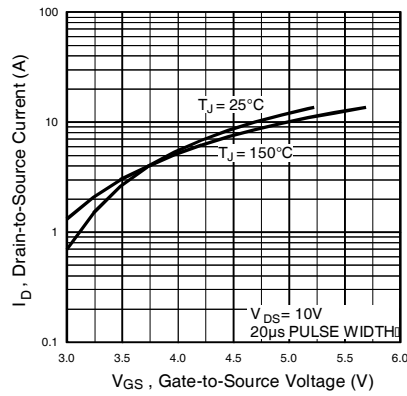
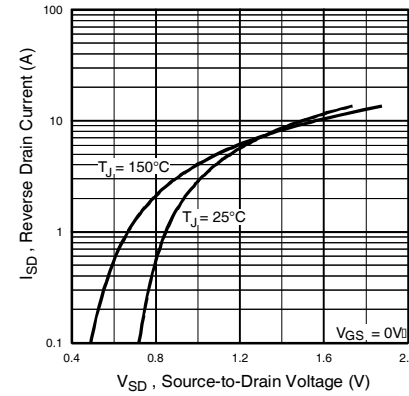
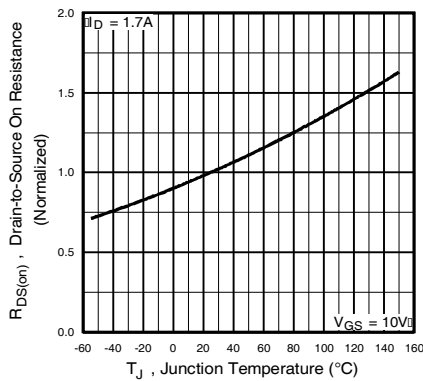
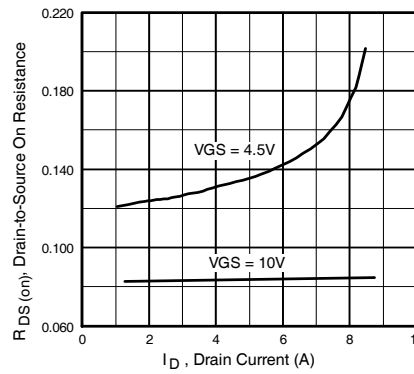
Fig 1. Typical Output Characteristics

Fig 2. Typical Output Characteristics

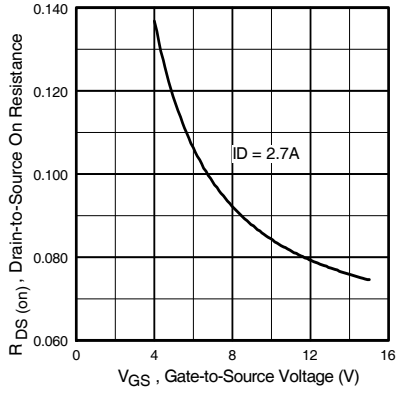
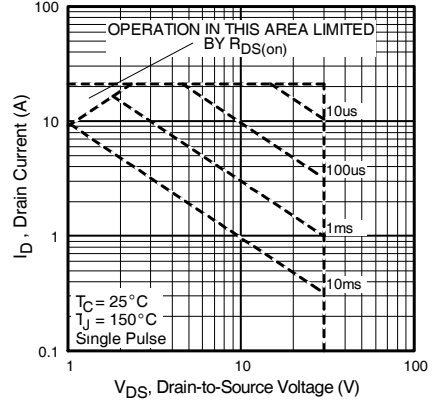
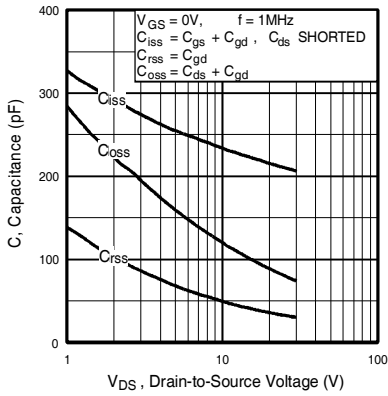
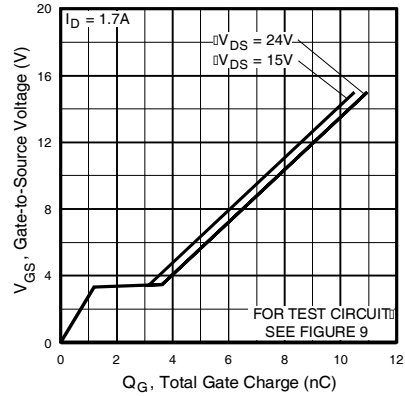
Fig 3. Typical Transfer Characteristics

Fig 4. Typical Source-Drain Diode Forward Voltage

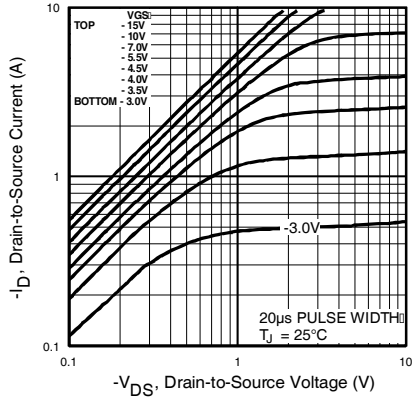
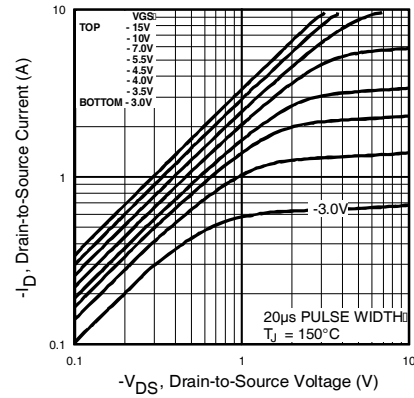
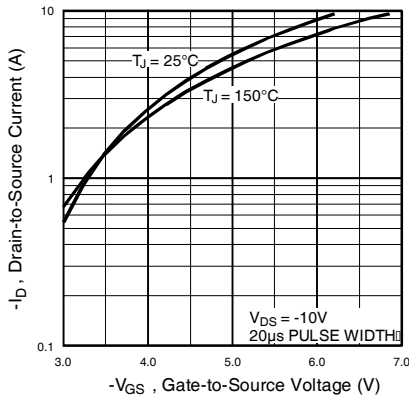
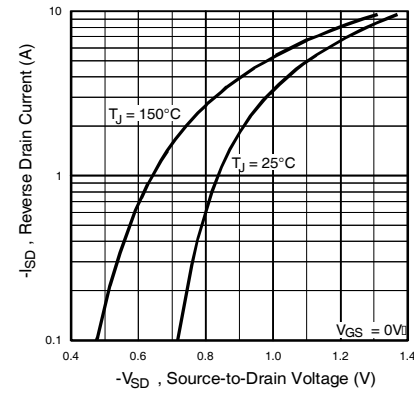
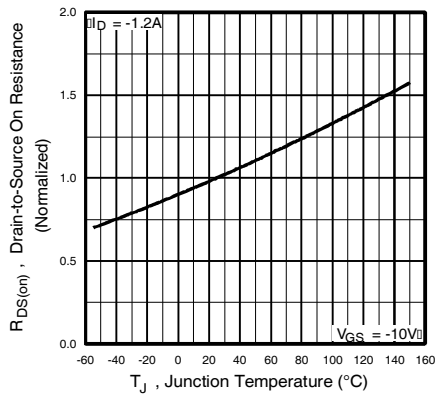
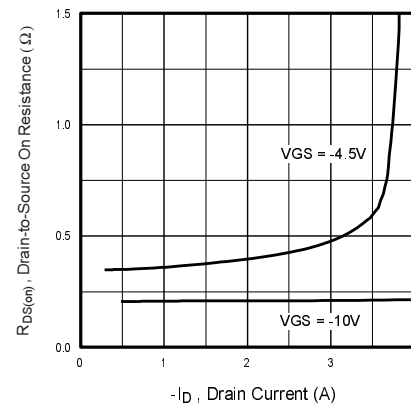
Fig 5. Normalized On-Resistance Vs. Temperature

Fig 6. Typical On-Resistance Vs. Drain Current

N - Channel

Fig 7. Typical On-Resistance Vs. Gate Voltage

Fig 8. Maximum Safe Operating Area

Fig 9. Typical Capacitance Vs. Drain-to-Source Voltage

Fig 10. Typical Gate Charge Vs. Gate-to-Source Voltage

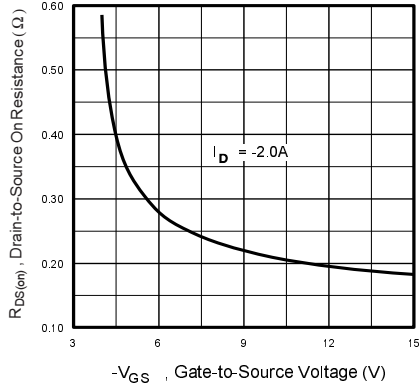
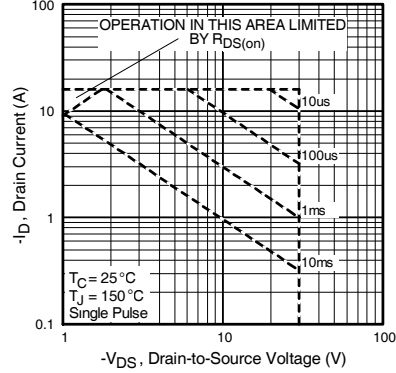
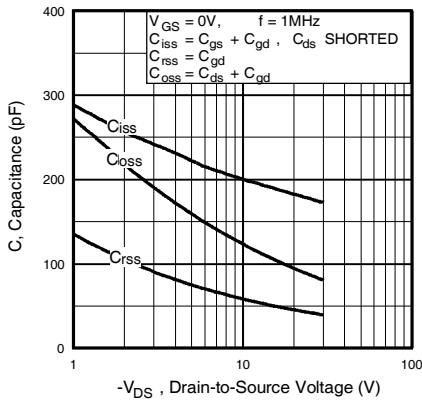
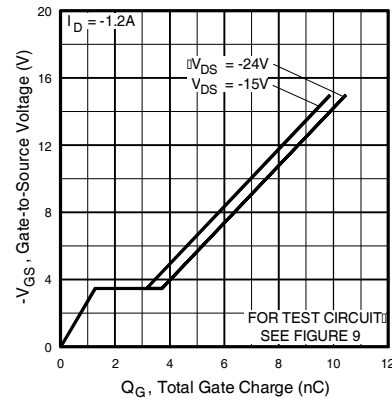
P - Channel

Fig 11. Typical Output Characteristics

Fig 12. Typical Output Characteristics

Fig 13. Typical Transfer Characteristics

Fig 14. Typical Source-Drain Diode Forward Voltage

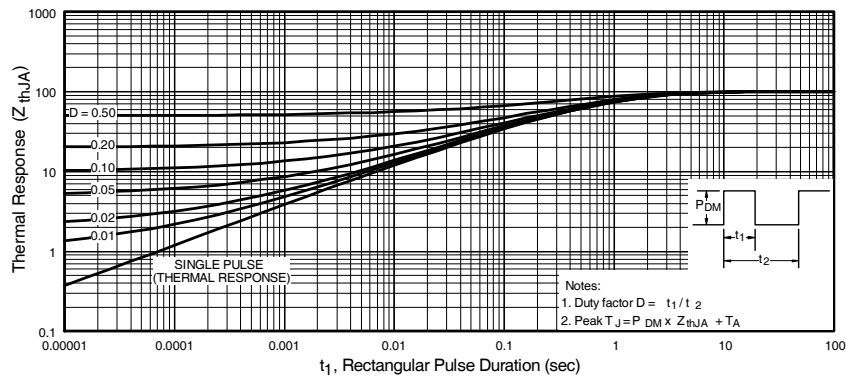
Fig 15. Normalized On-Resistance Vs. Temperature

Fig 16. Typical On-Resistance Vs. Drain Current

P - Channel

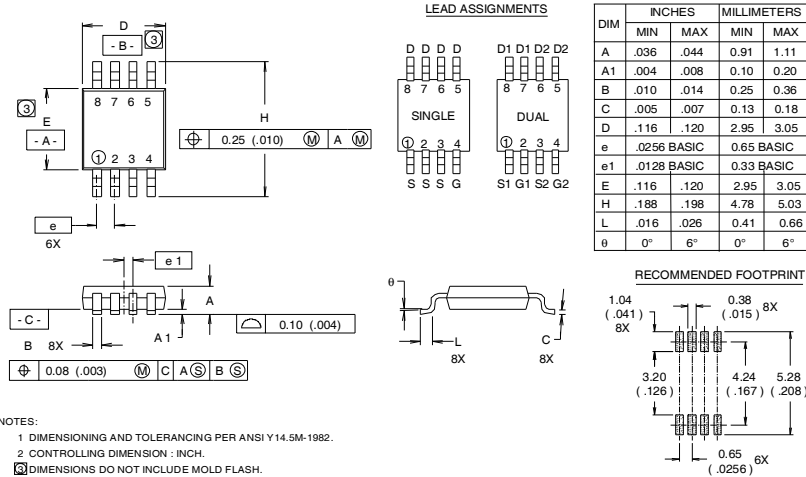

Fig 17. Typical On-Resistance Vs. Gate Voltage

Fig 18. Maximum Safe Operating Area

Fig 19. Typical Capacitance Vs. Drain-to-Source Voltage

Fig 20. Typical Gate Charge Vs. Gate-to-Source Voltage

N-P - Channel

Fig 21. Maximum Effective Transient Thermal Impedance, Junction-to-Ambient

Micro8 Package Outline

Dimensions are shown in millimeters (inches)



Micro8 Part Marking Information (Lead-Free)

EXAMPLE: THIS IS AN IRF7501

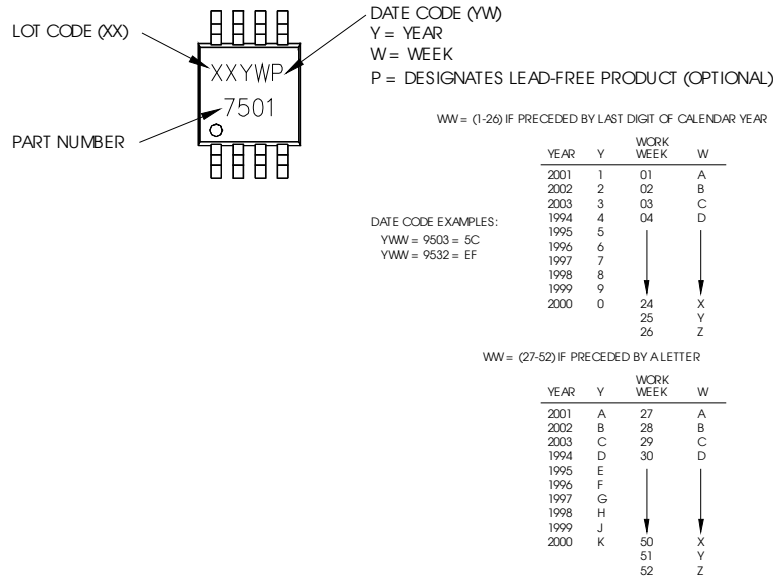

Note: For the most current drawing please refer to IR website at: <http://www.irf.com/package/>

Micro8 Tape & Reel Information

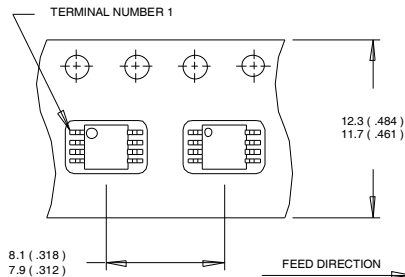

- NOTES:
1. OUTLINE CONFORMS TO EIA-481 & EIA-541.
 2. CONTROLLING DIMENSION : MILLIMETER.

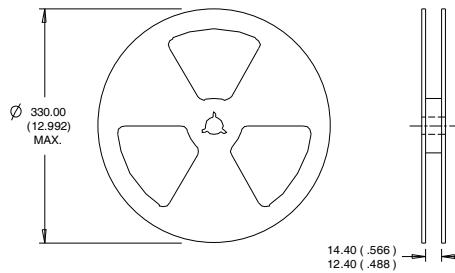

- NOTES:
1. CONTROLLING DIMENSION : MILLIMETER.
 2. OUTLINE CONFORMS TO EIA-481 & EIA-541.

Note: For the most current drawing please refer to IR website at: <http://www.irf.com/package/>

Qualification information[†]

Qualification level	Industriid (per JEDEC JESD47F ^{††} guidelines)	
Moisture Sensitivity Level	Micro-8	MSL1 (per JEDEC J-STD-020D ^{††})
RoHS compliant	Yes	

[†] Qualification standards can be found at International Rectifier's web site: <http://www.irf.com/product-info/reliability>

^{††} Applicable version of JEDEC standard at the time of product release

International
 Rectifier

IR WORLD HEADQUARTERS: 101 N. Sepulveda Blvd., El Segundo, California 90245, USA
 To contact International Rectifier, please visit <http://www.irf.com/whoto-call/>