

**1.5MHZ SYNCHRONOUS STEP-DOWN DC-DC CONVERTER**

**Description**

The AP3417C is a high efficiency step-down DC-DC voltage converter. The chip operation is optimized by peak-current mode architecture with built-in synchronous power MOSFET switchers. The oscillator and timing capacitors are all built-in providing an internal switching frequency of 1.5MHz that allows the use of small surface mount inductors and capacitors for portable product implementations.

Integrated Soft Start (SS), Under Voltage Lock Out (UVLO), Thermal Shutdown Detection (TSD) and Short Circuit Protection are designed to provide reliable product applications.

The device is available in adjustable output voltage version ranging from 0.6V to  $0.9 \times V_{IN}$  when input voltage range is from 2.5V to 5.5V, and is able to deliver up to 1A. It is also available in fixed voltage versions of 1.2V, 1.8V and 3.3V without external feedback resistance.

The AP3417C is available in SOT-23-5 and DFN-2x2-6 packages.

**Features**

- High Efficiency Buck Power Converter
- Wide Input Voltage Range: 2.5V to 5.5V
- Adjustable Output Voltage: 0.6V to  $0.9 \times V_{IN}$
- Low  $R_{DS(ON)}$  Internal Switches:  $200m\Omega$  ( $V_{IN} = 5V$ )
- Built-in Power Switches for Synchronous Rectification with High Efficiency
- Output Current: 1.0A
- Feedback Voltage: 600mV
- 1.5MHz Constant Frequency Operation
- Thermal Shutdown Protection
- Low Dropout Operation at 100% Duty Cycle
- No Schottky Diode Required
- Input Over Voltage Protection
- Output Over Voltage Protection
- Over Current Protection

**Pin Assignments**

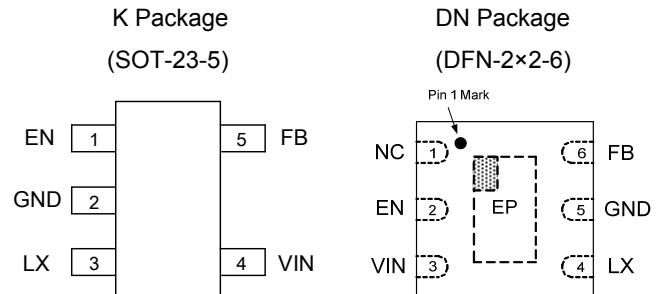

**Applications**

- Post DC-DC Voltage Regulation
- PDA and Notebook Computer

**Typical Applications Circuit**

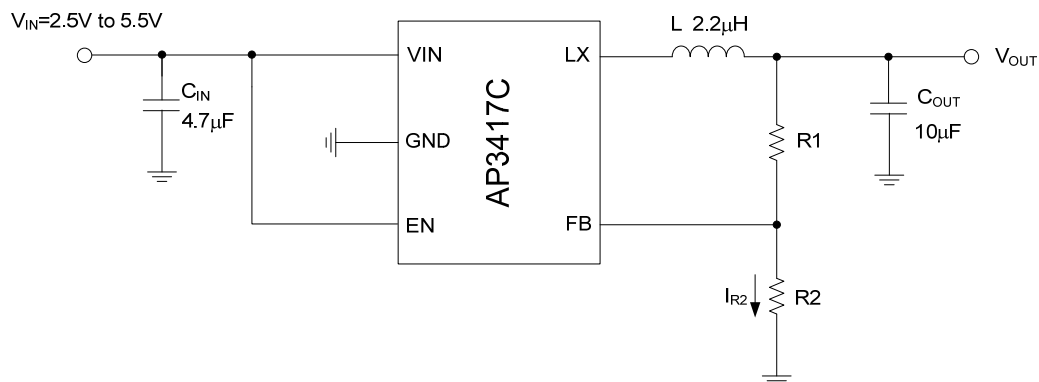

**Typical Applications Circuit (cont.)**

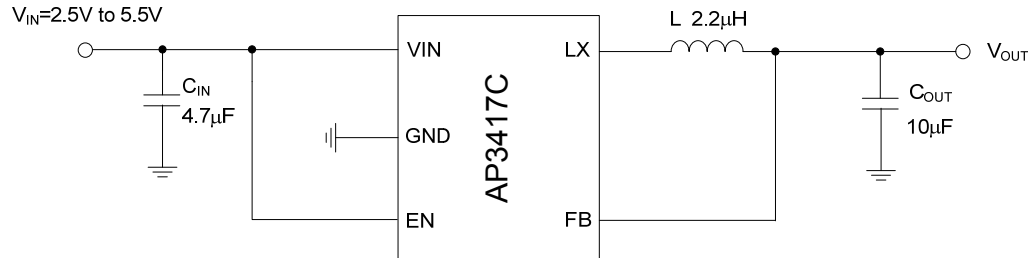

For Fixed Versions

**Component Guide**

V <sub>OUT</sub> (V)	R1 (kΩ)	R2 (kΩ)	L (µH)
3.3	450	100	2.2
2.5	320	100	2.2
1.8	200	100	2.2
1.2	100	100	2.2
1.0	66	100	2.2

**Pin Descriptions**

Pin Number		Pin Name	Function
SOT-23-5	DFN-2x2-6		
1	2	EN	Chip enable pin. Active high
2	5	GND	Ground pin
3	4	LX	Switch output pin
4	3	VIN	Power supply
5	6	FB	Feedback voltage of output
	1	NC	No internal connection

**Functional Block Diagram**

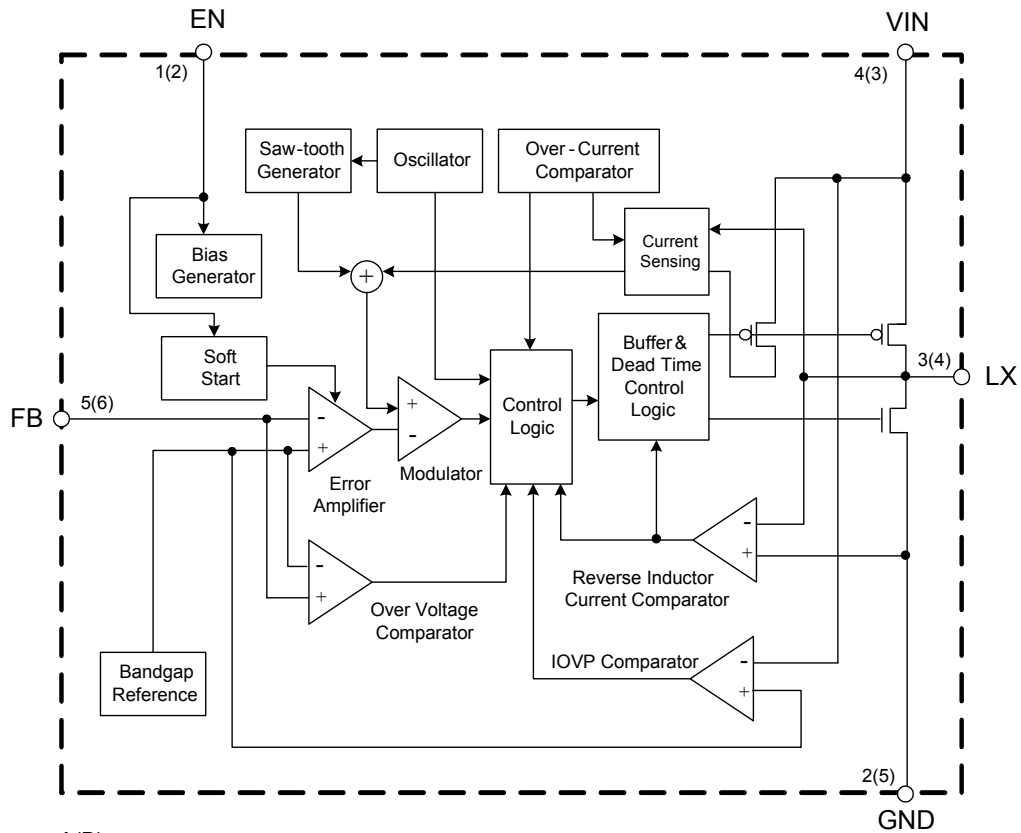

A(B)  
A for SOT-23-5  
B for DFN-2×2-6

**Absolute Maximum Ratings** (Note 1)

Symbol	Parameter	Rating		Unit
$V_{IN}$	Input Voltage for the MOSFET Switch	0 to 6.0		V
$V_{EN}$	Enable Input Voltage	-0.3 to $V_{IN} + 0.3$		V
$I_{LX}$	LX Pin Switch Current	1.8		A
$P_D$	Power Dissipation (On PCB, $T_A = +25^\circ\text{C}$ )	SOT-23-5	0.4	W
		DFN-2×2-6	1.89	
$\theta_{JA}$	Thermal Resistance (Junction to Ambient, Simulation)	SOT-23-5	250	$^\circ\text{C/W}$
		DFN-2×2-6	53	
$\theta_{JC}$	Thermal Resistance (Junction to Case, Simulation)	SOT-23-5	130	$^\circ\text{C/W}$
$T_J$	Operating Junction Temperature	155		$^\circ\text{C}$
$T_{STG}$	Storage Temperature	-55 to +150		$^\circ\text{C}$
$T_{OP}$	Operating Temperature	-40 to +85		$^\circ\text{C}$
$V_{MM}$	ESD (Machine Model)	200		V
$V_{HBM}$	ESD (Human Body Model)	2000		V

Note: 1. Stresses greater than those listed under "Absolute Maximum Ratings" may cause permanent damage to the device. These are stress ratings only, and functional operation of the device at these or any other conditions beyond those indicated under "Recommended Operating Conditions" is not implied. Exposure to "Absolute Maximum Ratings" for extended periods may affect device reliability.

## Recommended Operating Conditions

Symbol	Parameter	Min	Max	Unit
$V_{IN}$	Supply Input Voltage	2.5	5.5	V
$T_A$	Operating Ambient Temperature	-40	85	°C
$T_J$	Operating Junction Temperature	-40	125	°C

## Electrical Characteristics (@ $V_{IN} = V_{EN} = 5V$ , $V_{OUT} = 1.2V$ , $V_{FB} = 0.6V$ , $L = 2.2\mu H$ , $C_{IN} = 4.7\mu F$ , $C_{OUT} = 10\mu F$ , $T_A = +25^\circ C$ , unless otherwise specified.)

Symbol	Parameters	Conditions	Min	Typ	Max	Unit
$V_{IN}$	Input Voltage Range		2.5		5.5	V
$I_{OFF}$	Shutdown Current	$V_{EN} = 0$			0.1	$\mu A$
$I_{ON}$	Active Current	$V_{FB} = 0.55V$		220		$\mu A$
$V_{FB}$	Regulated Feedback Voltage	For Adjustable Output Voltage	0.588	0.6	0.612	V
$V_{OUT}$	Output Voltage	Fixed Output 1.2V	1.176	1.2	1.224	V
		Fixed Output 1.8V	1.764	1.8	1.836	
		Fixed Output 3.3V	3.234	3.3	3.366	
$\Delta V_{OUT}/V_{OUT}$	Regulated Output Voltage Accuracy	$V_{IN} = 2.5V$ to $5.5V$ , $I_{OUT} = 0$ to $1.0A$	-3		3	%
$I_{PK}$	Peak Inductor Current		1.5	1.9		A
$f_{OSC}$	Oscillator Frequency	$V_{IN} = 2.5V$ to $5.5V$	1.2	1.5	1.8	MHz
$R_{DS(ON)P}$	PMOSFET $R_{DS(ON)}$	$V_{IN} = 5V$		200		$m\Omega$
$R_{DS(ON)N}$	NMOSFET $R_{DS(ON)}$	$V_{IN} = 5V$		200		$m\Omega$
$V_{EN\_H}$	EN High Level Input Voltage		1.5			V
$V_{EN\_L}$	EN Low Level Input Voltage				0.4	V
$I_{EN}$	EN Input Current				0.1	$\mu A$
$t_{SS}$	Soft Start Time			400		$\mu s$
$D_{MAX}$	Maximum Duty Cycle		100			%
$V_{UVLO}$	Under Voltage Lock Out Threshold	Rising		2.3		V
		Falling		2.1		
		Hysteresis		0.2		
$T_{SD}$	Thermal Shutdown	Hysteresis = $30^\circ C$		155	160	°C

**Performance Characteristics** (@ $V_{IN} = 5V$ ,  $T_A = +25^\circ C$ , unless otherwise specified.)

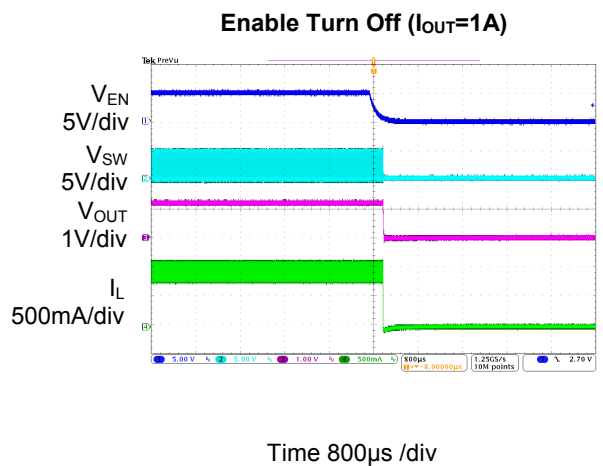
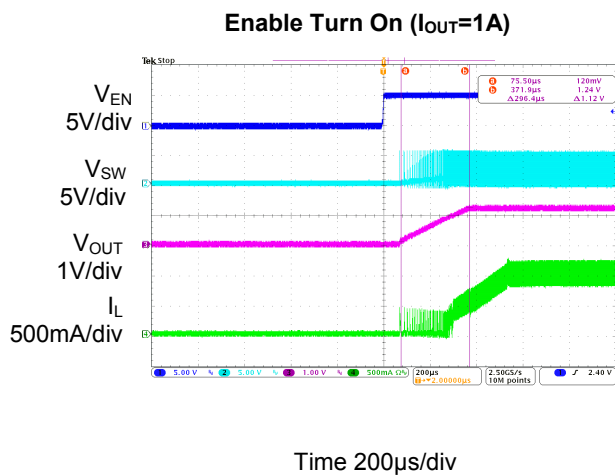
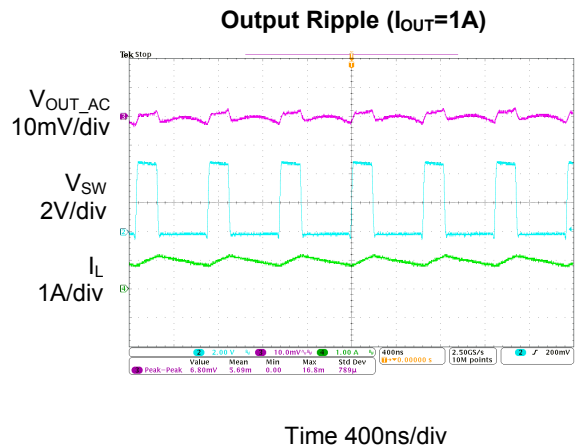
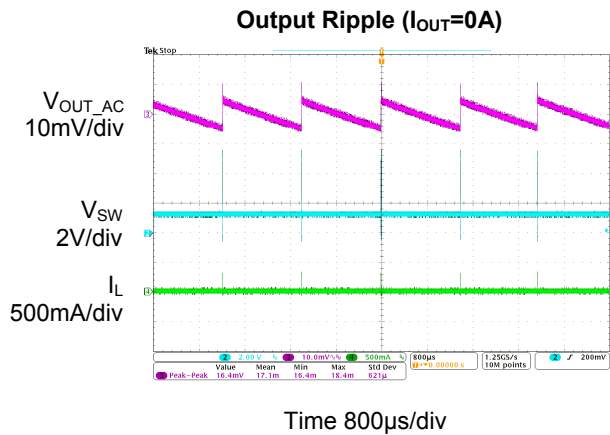
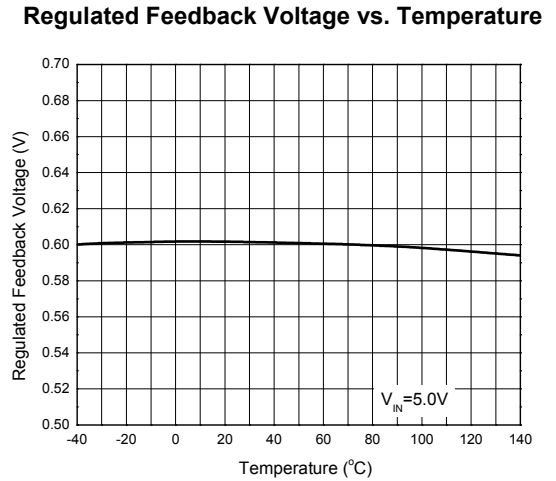
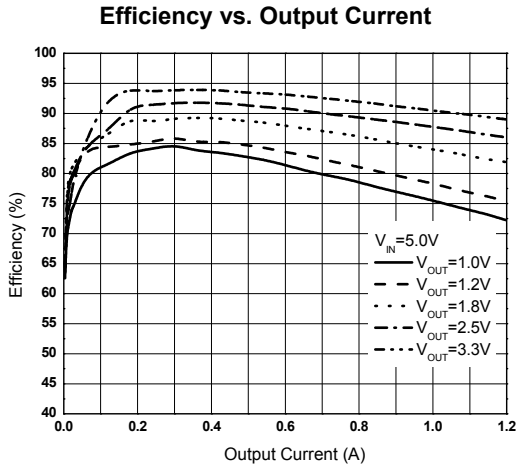

**Performance Characteristics** (cont.) (@ $V_{IN} = 5V$ ,  $T_A = +25^\circ C$ , unless otherwise specified.)

**Short Circuit Protection ( $I_{OUT}=1A$ )**

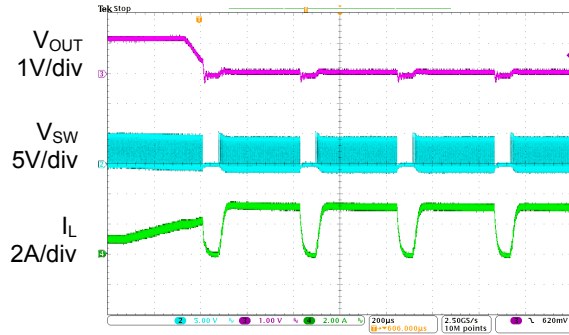

Time 200µs/div

**Short Circuit Protection Recovery ( $I_{OUT}=1A$ )**

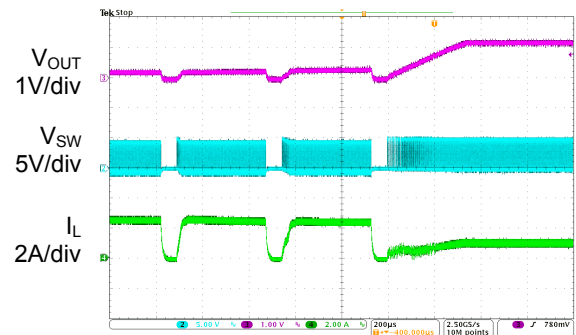

Time 200µs/div

**Ordering Information**

For ADJ Version

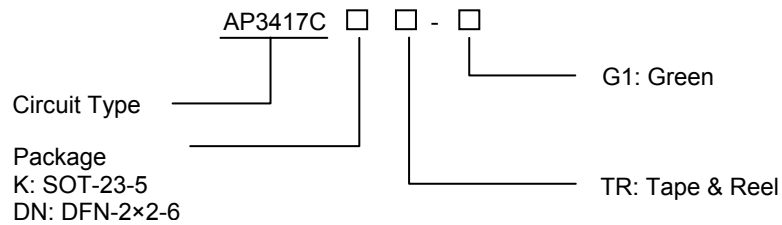

For Fixed Versions

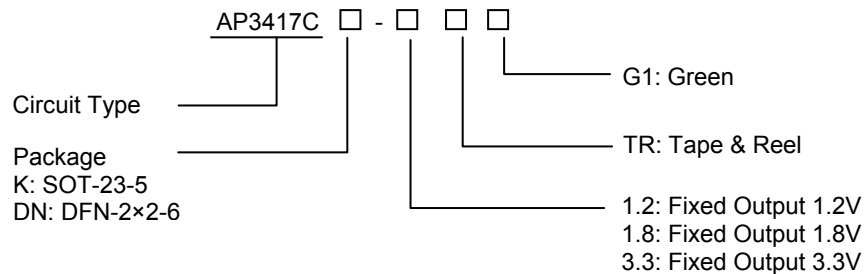

Package	Temperature Range	Part Number	Marking ID	Packing Type
SOT-23-5	-40 to 85°C	AP3417CKTR-G1	G4I	Tape & Reel
		AP3417CK-1.2TRG1	G4U	Tape & Reel
		AP3417CK-1.8TRG1	G4V	Tape & Reel
		AP3417CK-3.3TRG1	G4W	Tape & Reel
DFN-2×2-6	-40 to 85°C	AP3417CDNTR-G1	BH	Tape & Reel
		AP3417CDN-1.2TRG1	BL	Tape & Reel
		AP3417CDN-1.8TRG1	BM	Tape & Reel
		AP3417CDN-3.3TRG1	BN	Tape & Reel

BCD Semiconductor's Pb-free products, as designated with "G1" suffix in the part number, are RoHS compliant and green.

**Package Outline Dimensions** (All dimensions in mm(inch).)

**SOT-23-5**

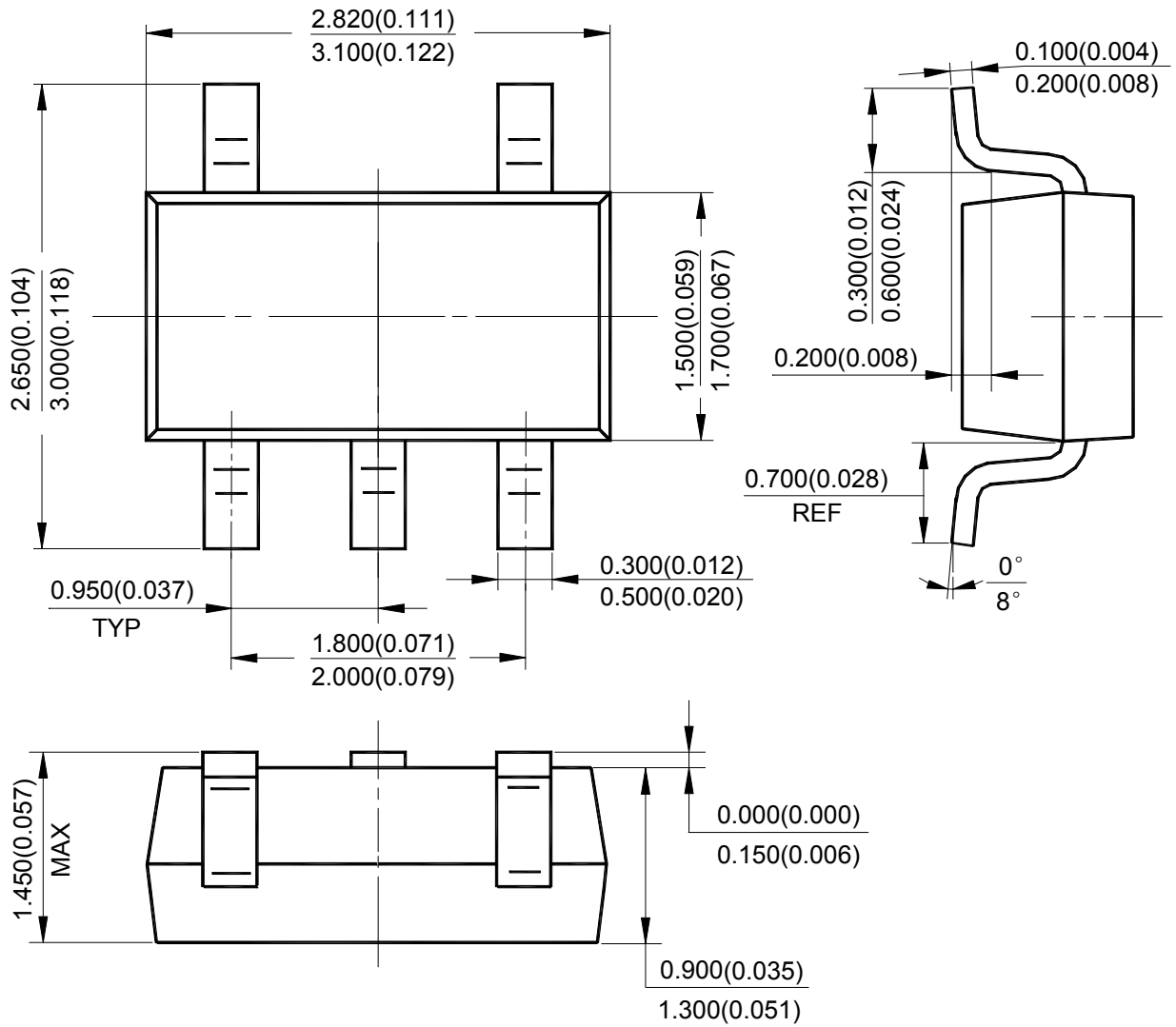

**Package Outline Dimensions** (cont.) (All dimensions in mm(inch).)

**DFN-2x2-6**

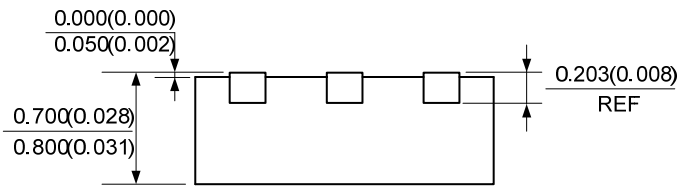
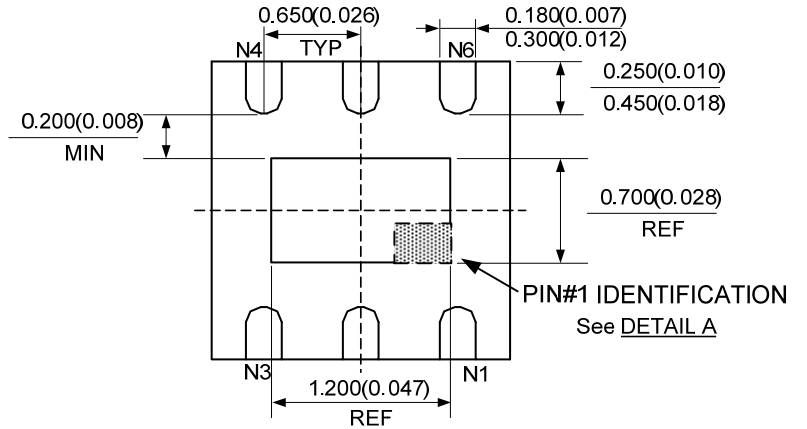
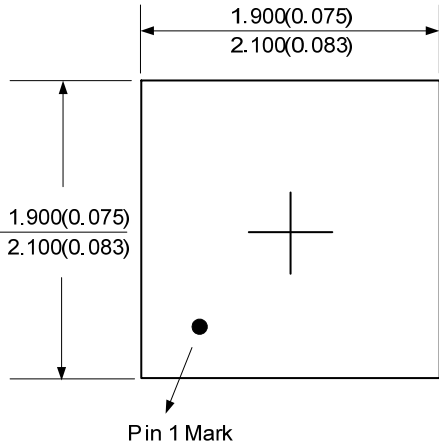

**DETAIL A**

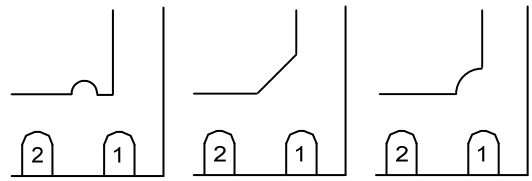

Pin 1 options



**Suggested Pad Layout**

SOT-23-5

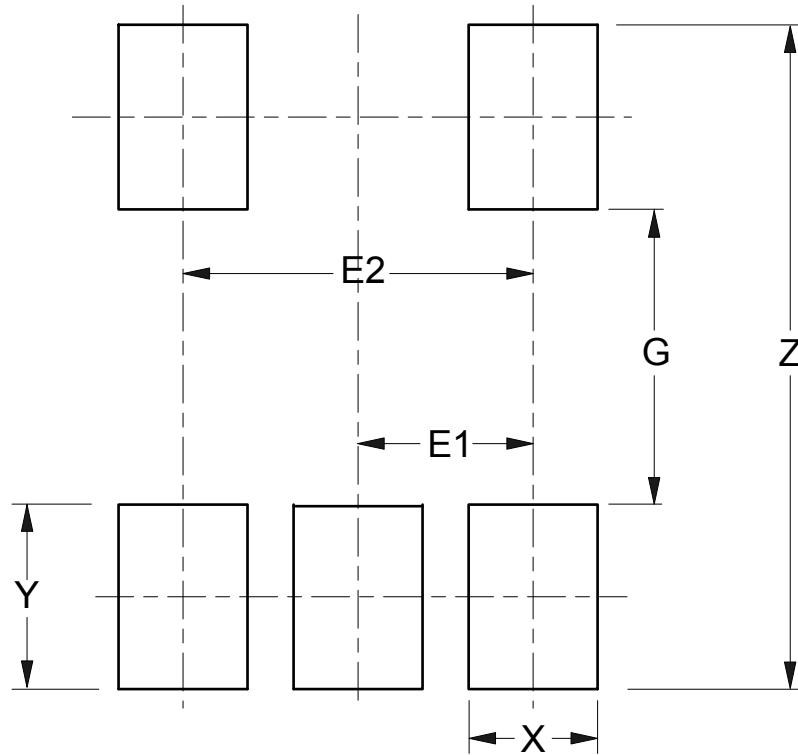

Dimensions	Z (mm)/(inch)	G (mm)/(inch)	X (mm)/(inch)	Y (mm)/(inch)	E1 (mm)/(inch)	E2 (mm)/(inch)
Value	3.600/0.142	1.600/0.063	0.700/0.028	1.000/0.039	0.950/0.037	1.900/0.075

**Suggested Pad Layout** (cont.)

DFN-2x2-6

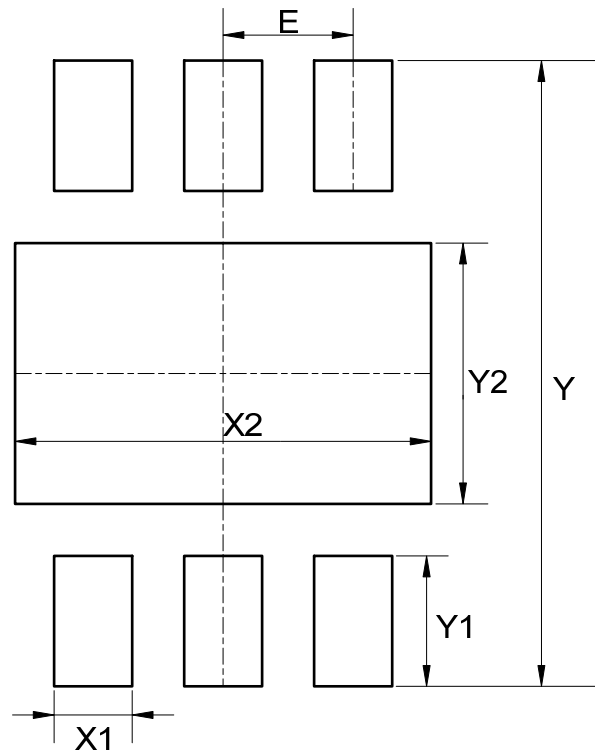

Dimensions	Y (mm)/(inch)	X1 (mm)/(inch)	Y1=E (mm)/(inch)	X2 (mm)/(inch)	Y2 (mm)/(inch)
Value	2.400/0.094	0.300/0.012	0.500/0.020	1.600/0.063	1.000/0.039

**IMPORTANT NOTICE**

DIODES INCORPORATED MAKES NO WARRANTY OF ANY KIND, EXPRESS OR IMPLIED, WITH REGARDS TO THIS DOCUMENT, INCLUDING, BUT NOT LIMITED TO, THE IMPLIED WARRANTIES OF MERCHANTABILITY AND FITNESS FOR A PARTICULAR PURPOSE (AND THEIR EQUIVALENTS UNDER THE LAWS OF ANY JURISDICTION).

Diodes Incorporated and its subsidiaries reserve the right to make modifications, enhancements, improvements, corrections or other changes without further notice to this document and any product described herein. Diodes Incorporated does not assume any liability arising out of the application or use of this document or any product described herein; neither does Diodes Incorporated convey any license under its patent or trademark rights, nor the rights of others. Any Customer or user of this document or products described herein in such applications shall assume all risks of such use and will agree to hold Diodes Incorporated and all the companies whose products are represented on Diodes Incorporated website, harmless against all damages.

Diodes Incorporated does not warrant or accept any liability whatsoever in respect of any products purchased through unauthorized sales channel. Should Customers purchase or use Diodes Incorporated products for any unintended or unauthorized application, Customers shall indemnify and hold Diodes Incorporated and its representatives harmless against all claims, damages, expenses, and attorney fees arising out of, directly or indirectly, any claim of personal injury or death associated with such unintended or unauthorized application.

Products described herein may be covered by one or more United States, international or foreign patents pending. Product names and markings noted herein may also be covered by one or more United States, international or foreign trademarks.

This document is written in English but may be translated into multiple languages for reference. Only the English version of this document is the final and determinative format released by Diodes Incorporated.

**LIFE SUPPORT**

Diodes Incorporated products are specifically not authorized for use as critical components in life support devices or systems without the express written approval of the Chief Executive Officer of Diodes Incorporated. As used herein:

A. Life support devices or systems are devices or systems which:

1. are intended to implant into the body, or
2. support or sustain life and whose failure to perform when properly used in accordance with instructions for use provided in the labeling can be reasonably expected to result in significant injury to the user.

B. A critical component is any component in a life support device or system whose failure to perform can be reasonably expected to cause the failure of the life support device or to affect its safety or effectiveness.

Customers represent that they have all necessary expertise in the safety and regulatory ramifications of their life support devices or systems, and acknowledge and agree that they are solely responsible for all legal, regulatory and safety-related requirements concerning their products and any use of Diodes Incorporated products in such safety-critical, life support devices or systems, notwithstanding any devices- or systems-related information or support that may be provided by Diodes Incorporated. Further, Customers must fully indemnify Diodes Incorporated and its representatives against any damages arising out of the use of Diodes Incorporated products in such safety-critical, life support devices or systems.

Copyright © 2013, Diodes Incorporated

[www.diodes.com](http://www.diodes.com)