

ACMD-7605

Miniature UMTS Band 8 Duplexer

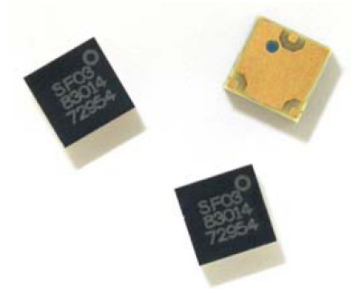

Data Sheet



Description

The Avago Technologies' ACMD-7605 is a miniature duplexer designed for use in UMTS Band 8 (880 – 915 MHz UL, 925 – 960 MHz DL) handsets and mobile data terminals.

The ACMD-7605 enhances the sensitivity and dynamic range of handset receivers by providing more than 51 dB attenuation of the transmitted signal at the receiver input and more than 48 dB rejection of transmit-generated noise in the receive band.

Maximum Insertion Loss in the Tx channel is only 3.5 dB, which minimizes current drain from the power amplifier. Insertion Loss in the Rx channel is a maximum of 4.0 dB, thus improving receiver sensitivity.

The ACMD-7605 is designed with Avago Technologies' Film Bulk Acoustic Resonator (FBAR) technology, which makes possible ultra-small, high-Q filters at a fraction of their usual size. The excellent power handling capability of the FBAR bulk-mode resonators supports the high output power levels needed in handsets while adding virtually no distortion.

The ACMD-7605 also utilizes Avago Technologies' innovative Microcap bonded-wafer, chip scale packaging technology. This process allows the filters to be assembled in a molded chip-on-board module that is less than 1.2 mm high with a maximum footprint of only 3.0 mm x 3.0 mm.

Functional Block Diagram

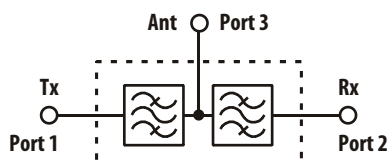

Features

- Miniature Size
 - 3.0 x 3.0 mm Max footprint
 - 1.2 mm Max height
- High Power Rating
 - 33 dBm Abs Max Tx Power
- RoHS Compliant

Specifications

- Rx Band Performance, 925-960 MHz, – 30 to +85°C
 - Insertion Loss: 4.0 dB max
 - Rx Noise Blocking: 48 dB min
- Tx Band Performance, 880-915 MHz, – 30 to +85°C
 - Insertion Loss: 3.5 dB max
 - Tx Interferer Blocking: 51 dB min

Applications

Handsets or data terminals operating in UMTS Band 8 frequency range.

ACMD-7605 Electrical Specifications [2][3], $Z_0=50 \Omega$, T_C [1] as indicated

Symbol	Parameter	Units	- 30°C			+25°C			+85°C		
			Min	Typ	Max	Min	Typ	Max	Min	Typ	Max
Antenna Port to Receive Port											
S23	Insertion Loss in Receive Band (925 – 960 MHz)	dB			4.0		1.4	4.0			4.0
S22	Return Loss (SWR) of Receive Port in Receive Band	dB	8.5		(2.2)	8.5	17.3	(2.2)	8.5		(2.2)
S23	Attenuation in Transmit Band (880 – 915 MHz)	dB	48			48	57		48		
S23	Attenuation, 0 – 835 MHz	dB	20			20	30		20		
S23	Attenuation, 835 – 870 MHz	dB	30			30	48		30		
S23	Attenuation, 1805 – 1875 MHz	dB	30			30	34		30		
S23	Attenuation in Bluetooth Band (2400 – 2500 MHz)	dB	30			30	51		30		
Transmit Port to Antenna Port											
S31	Insertion Loss in Transmit Band (880 – 915 MHz)	dB			3.5		1.3	3.0			3.5
S11	Return Loss (SWR) of Transmit Port in Transmit Band	dB	8.5		(2.2)	8.5	13.8	(2.2)	8.5		(2.2)
S31	Attenuation in Receive Band (925 – 960 MHz)	dB	45			45	59		45		
S31	Attenuation 0 – 820 MHz	dB	27			27	38		27		
S31	Attenuation in GPS Band (1574.42 – 1576.42 MHz)	dB	22			22	31		22		
S31	Attenuation in Transmit 2 nd Harmonic Band (1760 – 1830 MHz)	dB	20			20	30		20		
S31	Attenuation in Bluetooth Band (2400 – 2500 MHz)	dB	20			20	28		20		
Antenna Port											
S33	Return Loss (SWR) of Antenna Port in Receive Band (925 – 960 MHz)	dB	8.5		(2.2)	8.5	17.1	(2.2)	8.5		(2.2)
S33	Return Loss (SWR) of Antenna Port in Transmit Band (880 – 915 MHz)	dB	7.5		(2.5)	7.5	13.6	(2.5)	7.5		(2.5)
Isolation Transmit Port to Receive Port											
S21	Tx-Rx Isolation in Receive Band (925 – 960 MHz)	dB	48			48	57		48		
S21	Tx-Rx Isolation in Transmit Band (880 – 915 MHz)	dB	51			51	59		51		

Notes:

1. T_C is the case temperature and is defined as the temperature of the underside of the Duplexer where it makes contact with the circuit board.
2. Min/Max specifications are guaranteed at the indicated temperature with the input power to the Tx ports equal to or less than +29 dBm over all Tx frequencies unless otherwise noted.
3. Typical data is the average value of the parameter over the indicated band at the specified temperature. Typical values may vary over time.

ACMD-7605

Absolute Maximum Ratings ^[1]

Parameter	Unit	Value
Storage temperature	°C	-65 to +125
Maximum RF Input Power to Tx Port	dBm	+33

Maximum Recommended Operating Conditions ^[2]

Parameter	Unit	Value
Operating temperature, T _c ^[3] , Tx Power ≤ 29 dBm	°C	-40 to +100
Operating temperature, T _c ^[3] , Tx Power ≤ 30 dBm	°C	-40 to +85

Notes:

1. Operation in excess of any one of these conditions may result in permanent damage to the device.
2. The device will function over the recommended range without degradation in reliability or permanent change in performance, but is not guaranteed to meet electrical specifications.
3. T_c is defined as case temperature, the temperature of the underside of the duplexer where it makes contact with the circuit board.

ACMD-7605 Typical Performance at $T_c = 25^\circ\text{C}$

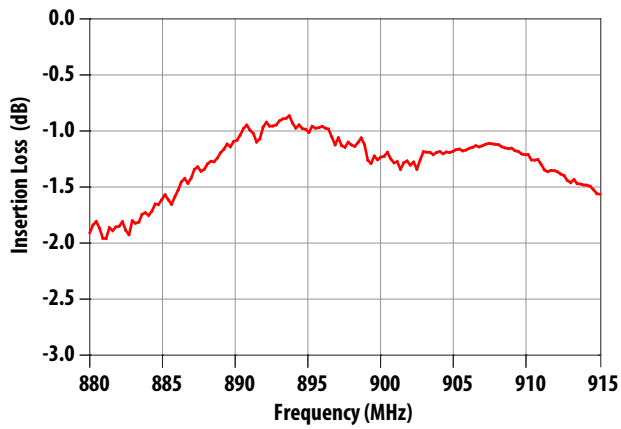

Figure 1. Tx-Ant Insertion Loss.

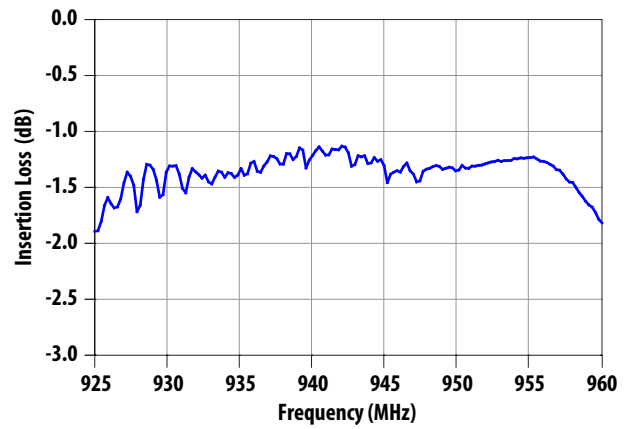

Figure 2. Ant-Rx Insertion Loss.

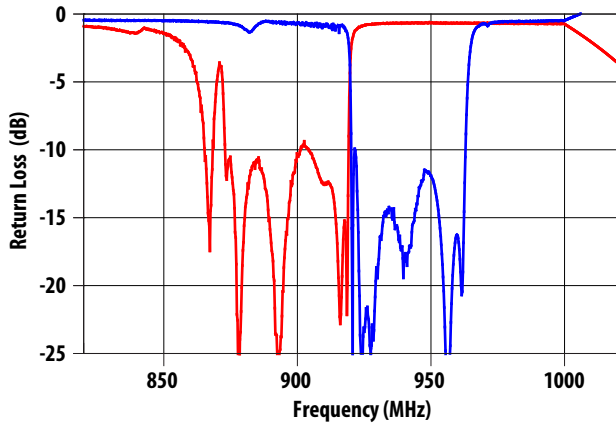

Figure 3. Tx and Rx Port Return Loss.

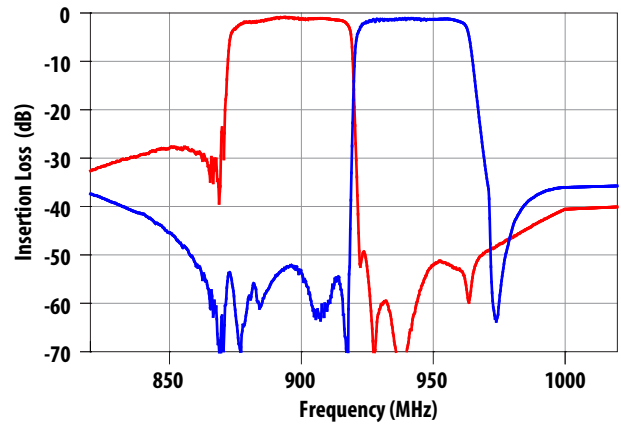

Figure 4. Tx Rejection in Rx Band and Rx Rejection in Tx Band.

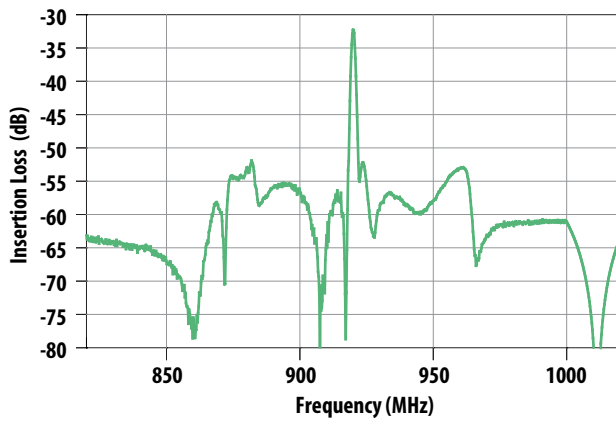

Figure 5. Tx-Rx Isolation.

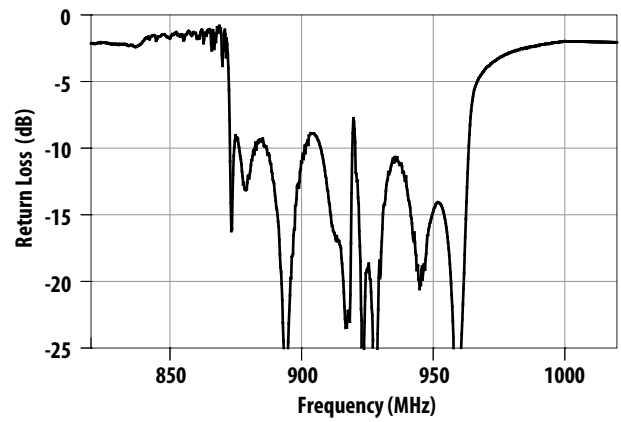

Figure 6. Antenna Port Return Loss.

ACMD-7605 Typical Performance at $T_c = 25^\circ\text{C}$

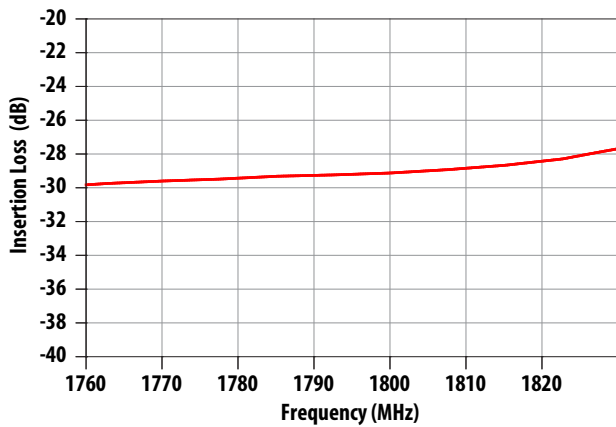

Figure 7. Tx-Ant Rejection at Tx Second Harmonic.

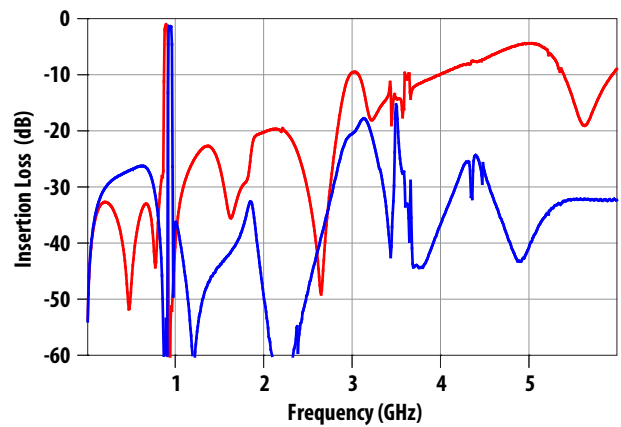

Figure 8. Tx-Ant and Ant-Rx Wideband Insertion Loss.

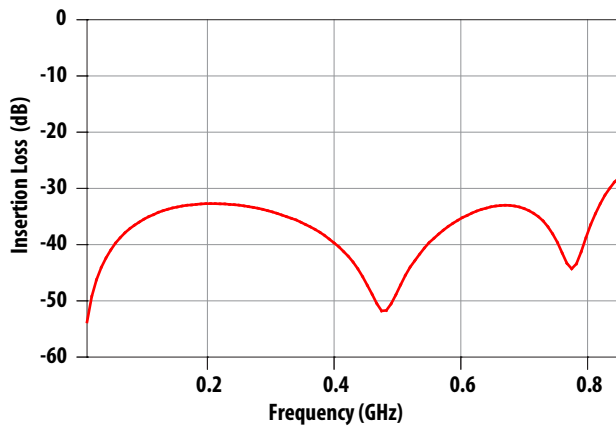

Figure 9. Tx-Ant Low Frequency Rejection.

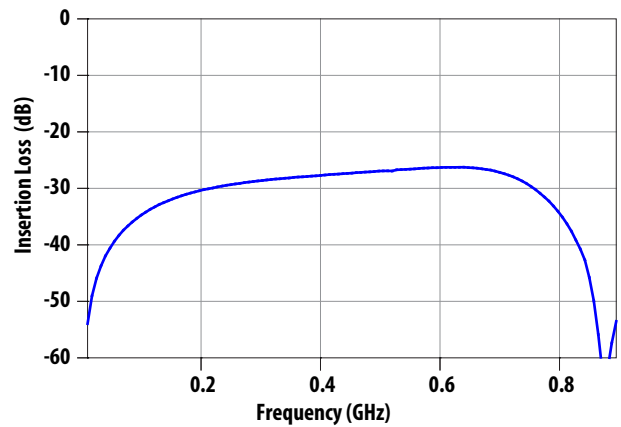

Figure 10. Ant-Rx Low Frequency Rejection.

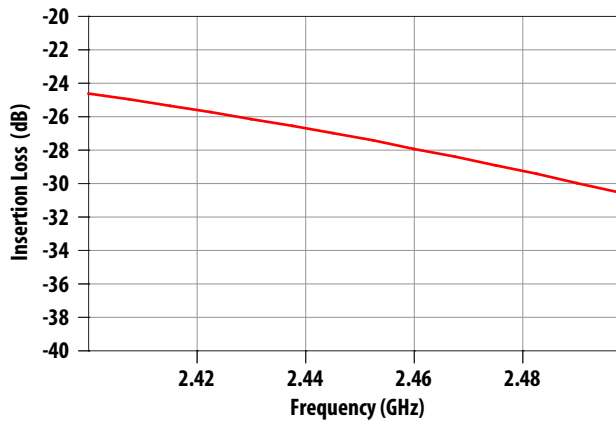

Figure 11. Tx Rejection in Bluetooth Band

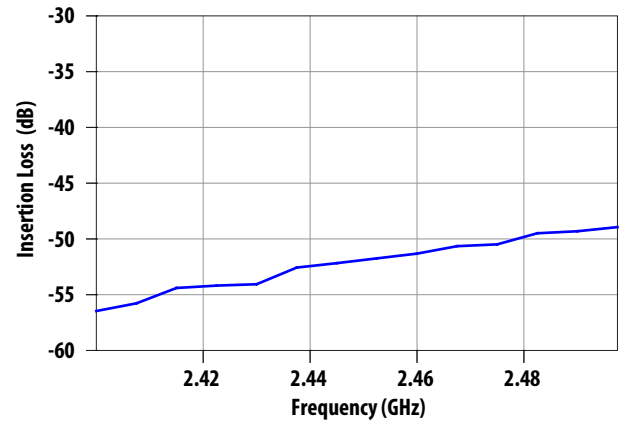

Figure 12. Rx Rejection in Bluetooth Band

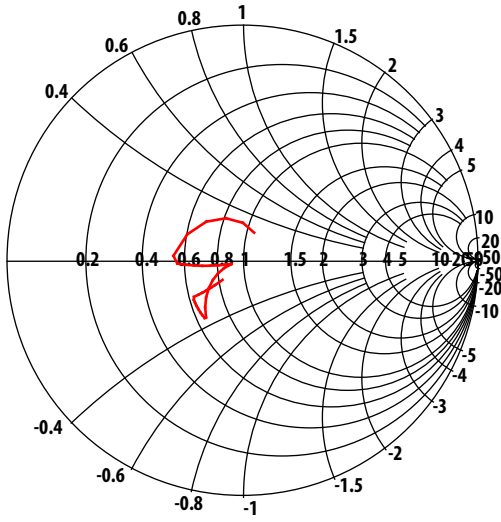

Figure 13. Tx Port Impedance in Tx Band.

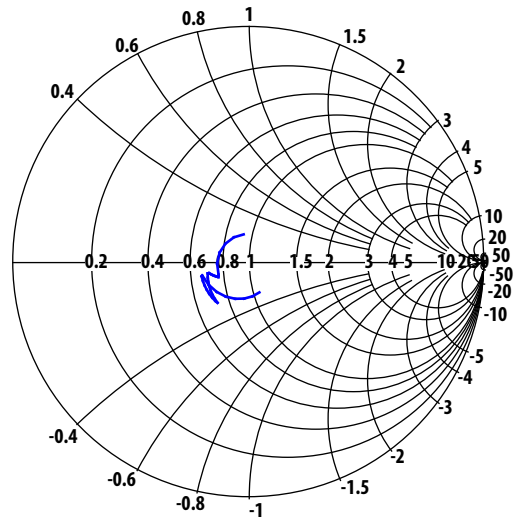

Figure 14. Rx Port Impedance in Rx Band.

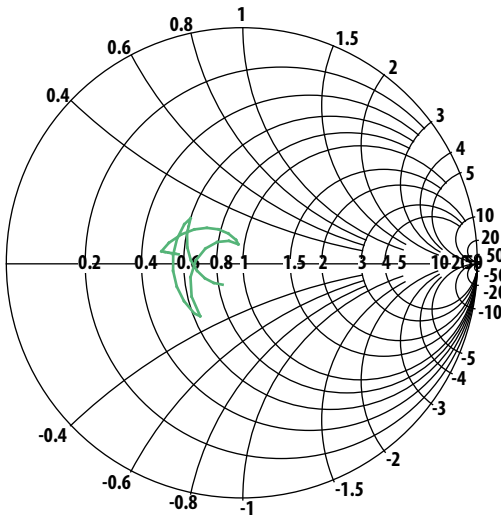

Figure 15. Ant Port Impedance in Tx Band.

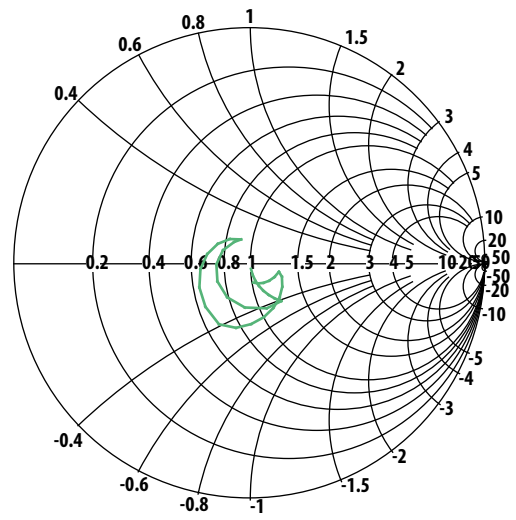
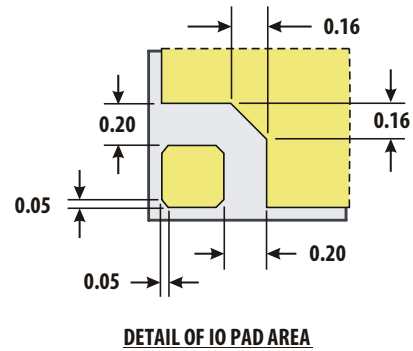
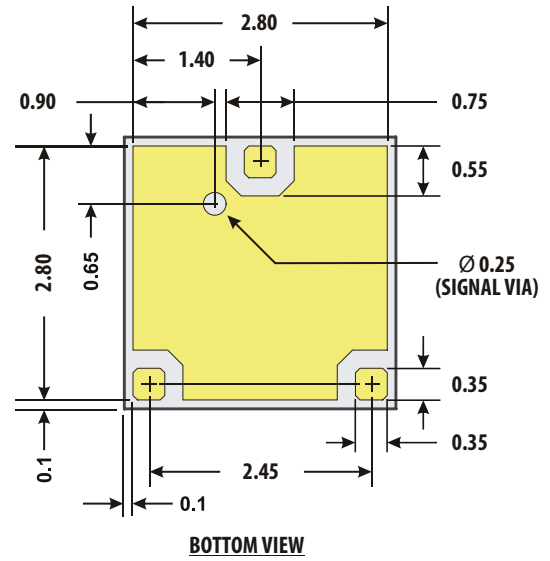
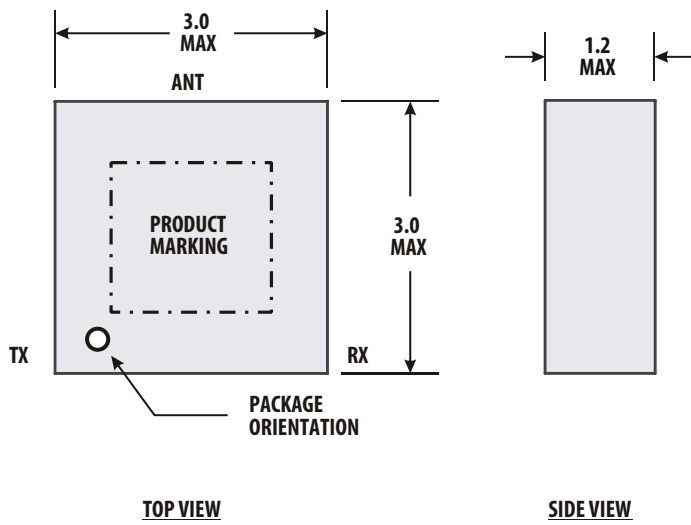

Figure 16. Ant Port Impedance in Rx Band.



- Notes:
1. Dimensions in millimeters
Tolerance: X.X ± 0.1 mm
X.XX ± 0.05 mm
 2. Dimensions nominal unless otherwise noted
 3. I/O Pads (3 ea)
Size: 0.35 X 0.35 mm, chamfer: 0.05 X 0.05 mm
Spacing to ground metal: 0.20 mm
 4. Signal via (1 ea) is covered with solder mask and shown for reference only. PCB metal under signal via does not need to be voided.
 5. Contact areas are gold plated.

Figure 17. Package Outline Drawing.

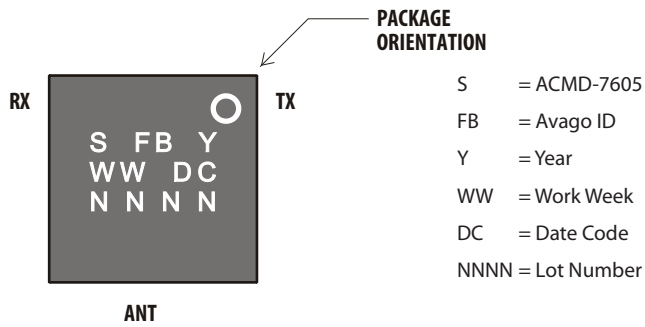
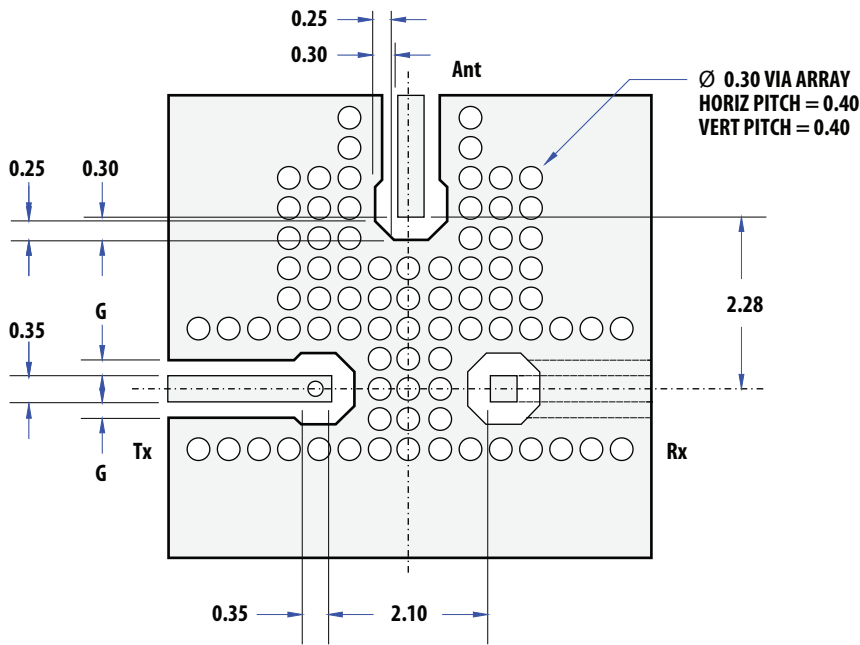

Figure 18. Product Marking.



Notes:

1. Dimensions in mm
2. Transmission line Gap (G) adjusted for $Z_0 = 50$ ohms
3. I/O Pads (3 ea) 0.35 X 0.35, corner chamfer 0.03
4. Ground vias positioned to maximize port-to-port isolation
5. Tx connection on optionally placed in buried metal layer

Figure 19. PCB Layout (top view).

A PCB layout using the principles illustrated in Figure 15 is recommended to optimize performance of the ACMD-7605.

It is important to maximize isolation between the Tx connection to the duplexer and the Rx port. High isolation is achieved by: (1) maintaining a continuous ground plane around the duplexer mounting area, and (2) surrounding the I/O ports with sufficient ground vias to enclose the connections in a "Faraday cage."

Depending on trace routing beyond the immediate vicinity of the duplexer, it may be advisable to place the Rx (Tx) trace in a different metal layer than the Rx (Tx). Having the Tx and Rx traces in different layers helps prevent leakage of the Tx signal into other components that could result in the creation of intermodulation products and degradation of overall system performance.

A sufficient number of vias should be used to ensure excellent RF grounding as well as good heat sinking for the device.

Note: It is not necessary to void the PCB ground plane under the metal void shown in Fig 13.

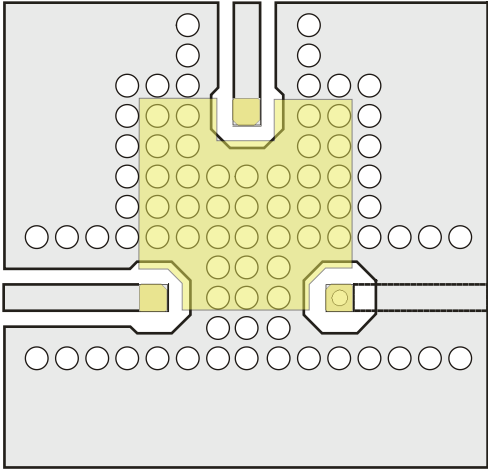

Figure 20. ACMD-7605 Superposed on PCB Layout (top view).

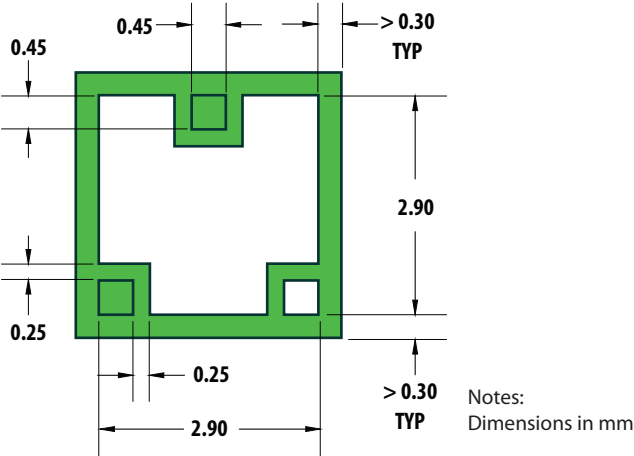

Figure 21. Recommended Solder Mask.

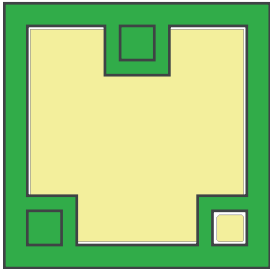
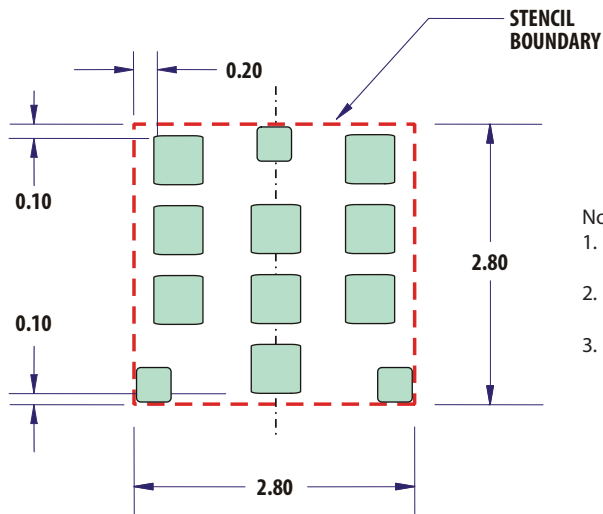

Figure 22. Solder Mask Superposed on ACMD-7605.



Notes:

1. Chamfer or radius all corners 0.05 mm min
2. Stencil openings aligned to Boundary rectangle or center lines
3. Non-I/O pad stencil openings aligned to 0.52 x 0.55 grid (i.e., spacing between openings: 0.2 vertical, 0.5 horizontal)

Stencil Opening ID	Qty	Width (mm)	Length (mm)
A (I/O pad areas)	3	0.35	0.35
All other openings	9	0.50	0.50

Figure 23. Recommended Solder Stencil.

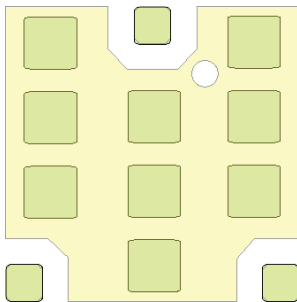

Figure 24. Solder Stencil Overlaid on ACMD-7605 Bottom Metal Pattern.

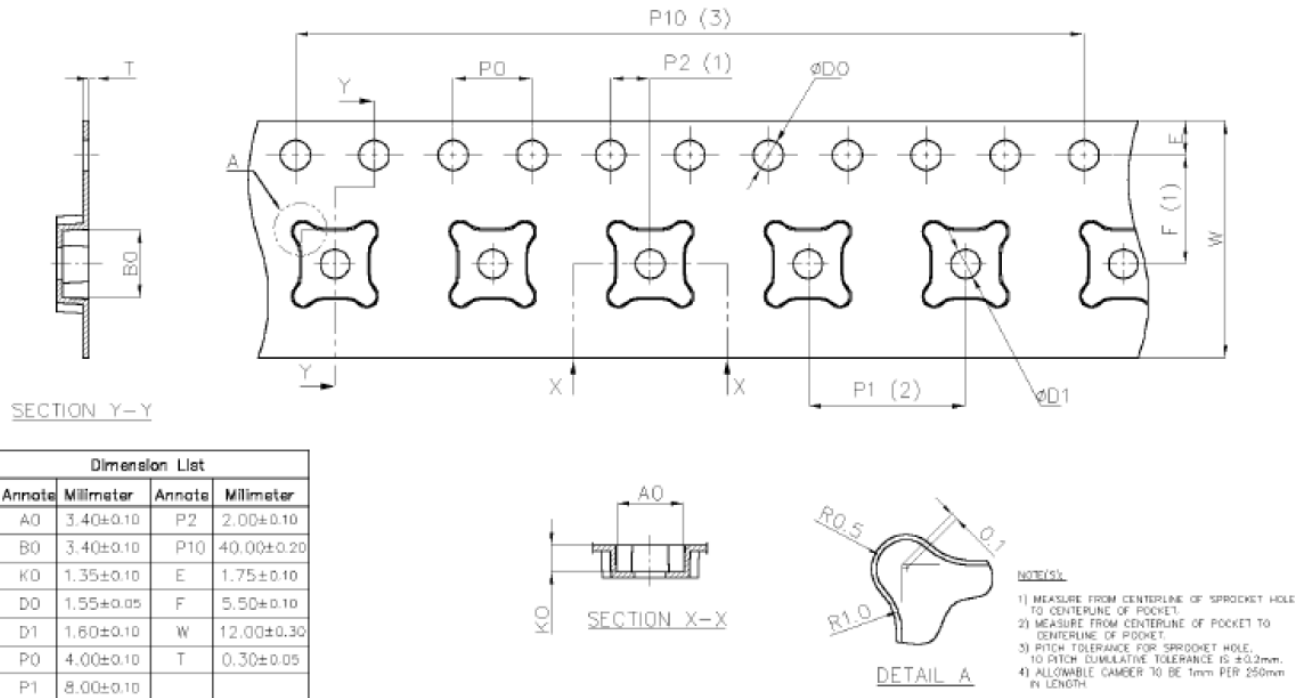

Figure 25. SMD Tape Packing.

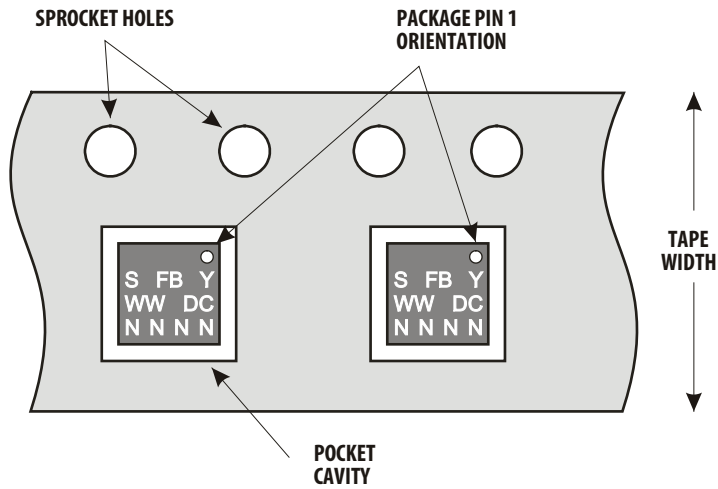

Figure 26. Unit Orientation in Tape.

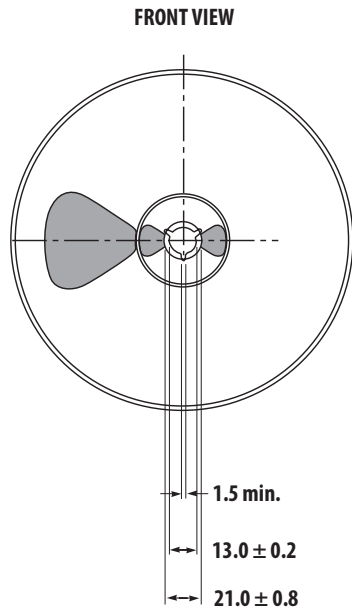

Figure 27. Reel Drawing, Front View.

NOTES:

1. Reel shall be labeled with the following information (as a minimum).
 - a. manufacturers name or symbol
 - b. Avago Technologies part number
 - c. purchase order number
 - d. date code
 - e. quantity of units
2. A certificate of compliance (c of c) shall be issued and accompany each shipment of product.
3. Reel must not be made with or contain ozone depleting materials.
4. All dimensions in millimeters (mm)

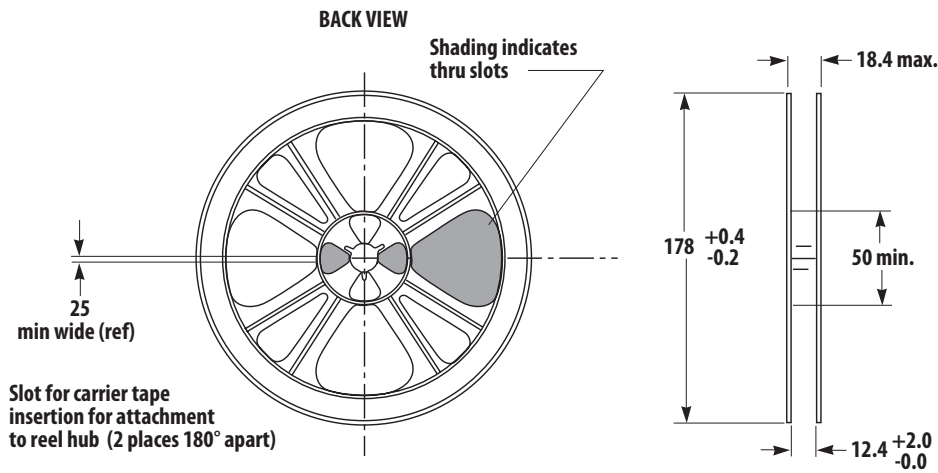

Figure 28. Reel Drawing, Back View.

Package Moisture Sensitivity

Feature	Test Method	Performance
Moisture Sensitivity Level (MSL) at 260°C	JESD22-A113D	Level 3

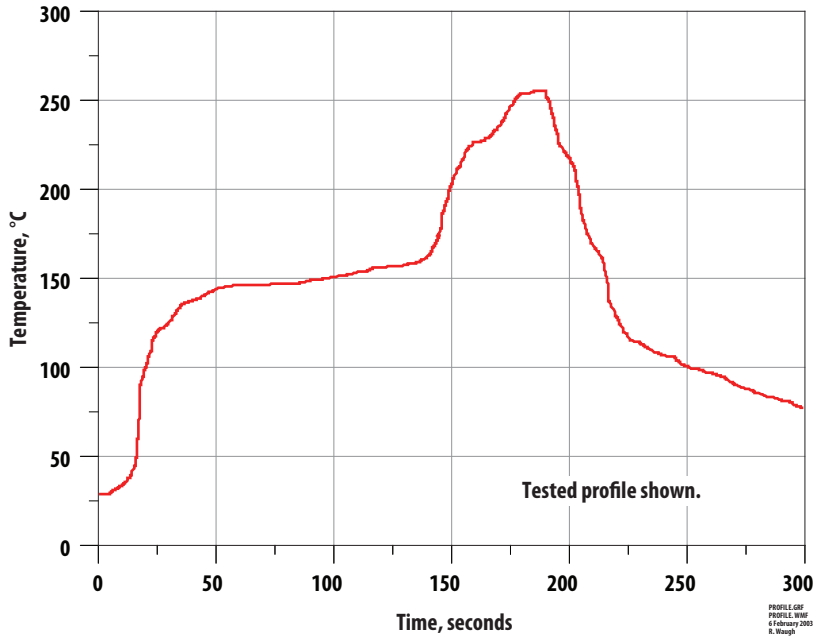

Figure 29. Verified SMT Solder Profile.

Ordering Information

Part Number	No. of Devices	Container
ACMD-7605-BLK	25	Anti-static Bag
ACMD-7605-TR1	1000	7-inch Reel

For product information and a complete list of distributors, please go to our web site: www.avagotech.com

Avago, Avago Technologies, and the A logo are trademarks of Avago Technologies in the United States and other countries. Data subject to change. Copyright © 2005-2009 Avago Technologies. All rights reserved.
AV02-1743EN - January 12, 2009

AVAGO
TECHNOLOGIES