

# RF3512

## 3V W-CDMA SINGLE-BAND POWER AMPLIFIER MODULE

The RF3512 single-band linear power amplifier supports B2 (1850-1910MHz) in 3.4V, 50Ω mobile equipment designed for 3G UMTS transmit. RF3512 meets the spectral linearity requirements of HSDPA, HSUPA and HSPA+ with high power added efficiency. Two digital control pins selects high, medium or low power modes to optimize performance and current drain at different power levels. RF3512 integrates a directional coupler that eliminates the need for an external discrete coupler.

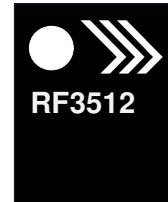

Package: Module, 10-pin,  
2.0mm x 2.5mm x 0.9mm

### Features

- Band 2 Operation
- HSDPA/HSUPA/HSPA+
- Linear Output Power to 27.5 dBm
- High Efficiency 41% at 27.5 dBm
- 3 Power Mode Operation
- Integrated Power Coupler
- No External DC Block Needed
- Digital Control Interface
- Ultra Small and Low Profile Package

### Applications

- WCDMA/HSPDA/HSUPA/HSPA+ Wireless Handsets and Data Cards

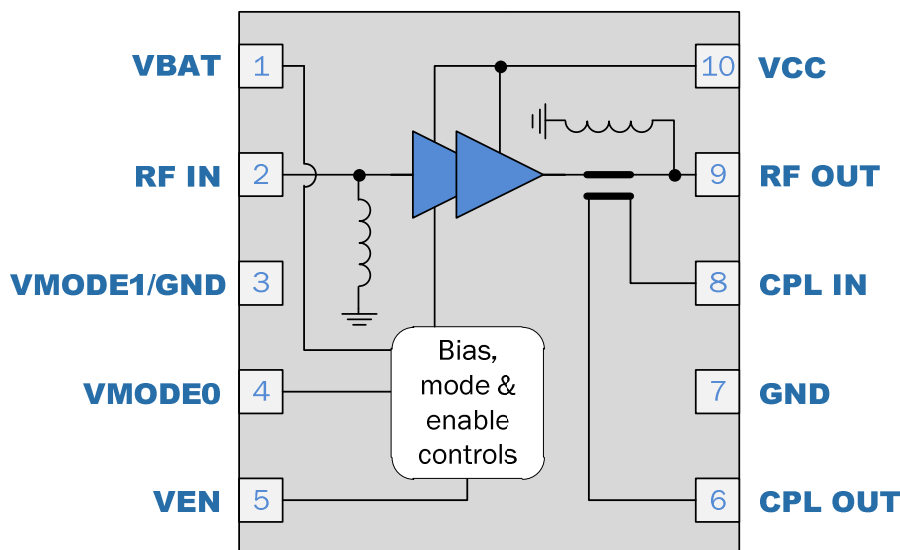

Functional Block Diagram

### Ordering Information

RF3512	3V W-CDMA Band 2 PA Module
RF3512SB	5 Piece Sample Bag + 3512-410 PCBA
RF3512SQ	25 Piece Sample Bag
RF3512SR	100 Piece 7" Reel
RF3512TR7	2500 Piece 7" Reel
RF3512TR7X	7" tape and reel, non-standard quantity only
RF3512PCBA-410	Fully Assembled Evaluation Board