

GPDN5113

RECTIFIER DIODE

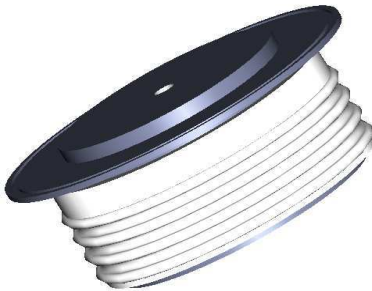

BLOCKING VOLTAGE UP TO **5000 V**
AVERAGE CURRENT **1135 A**
SURGE CURRENT **12 kA**

BLOCKING CHARACTERISTICS

Characteristic		Conditions	Value
V _{RRM}	Repetitive peak reverse voltage		5000 V
V _{RSM}	Non-repetitive peak reverse voltage		5100 V
I _{RRM}	Repetitive peak reverse current, max.	V _{RRM} , single phase, half wave, T _{jmax}	50 mA

FORWARD CHARACTERISTICS

I _{F(AV)}	Average forward current	Sine wave, 180° conduction, T _h = 55°C	1135 A
I _{F(RMS)}	R.M.S. forward current	Sine wave, 180° conduction, T _h = 55°C	1783 A
I _{FSM}	Surge forward current	Non rep. half sine wave, 50 Hz, V _R = 0 V, T _j = T _{jmax}	12 kA
I ² t	I ² t for fusing coordination		720 kA ² s
V _{F(TO)}	Threshold voltage	T _j = T _{jmax}	0,894 V
r _F	Forward slope resistance	T _j = T _{jmax}	0,487 mΩ
V _{FM}	Peak forward voltage, max	Forward current I _F = 1500 A, T _j = T _{jmax}	1,62 V

SWITCHING CHARACTERISTICS

Q _{rr}	Reverse recovery charge, typ	T _j = T _{jmax} , I _F = A, di/dt = A/μs	μC
I _{rr}	Reverse recovery current		A

THERMAL AND MECHANICAL CHARACTERISTICS

R _{th(j-c)}	Thermal resistance (junction to case)	Double side cooled	0,034 °C/W
R _{th(c-h)}	Thermal resistance (case to heatsink)	Double side cooled	0,007 °C/W
T _{jmax}	Max operating junction temperature		160 °C
T _{stg}	Storage temperature		-40 / 160 °C
F	Clamping force ± 10%		11 kN
	Mass		300 g

Current rating - sine wave

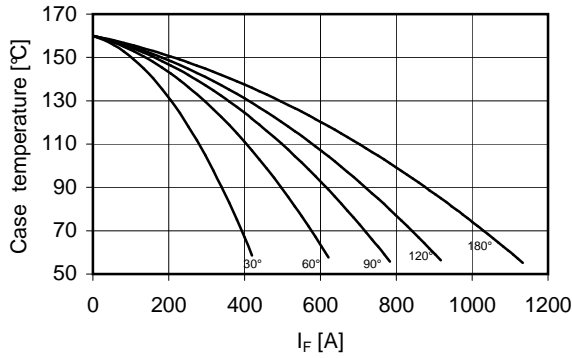

Power loss - sine wave

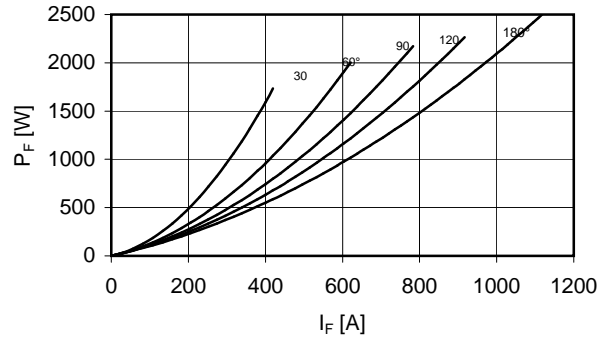

Maximum surge current
d.s. cooled

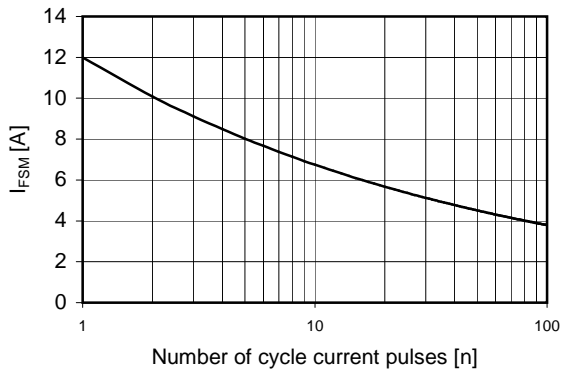

Forward voltage drop

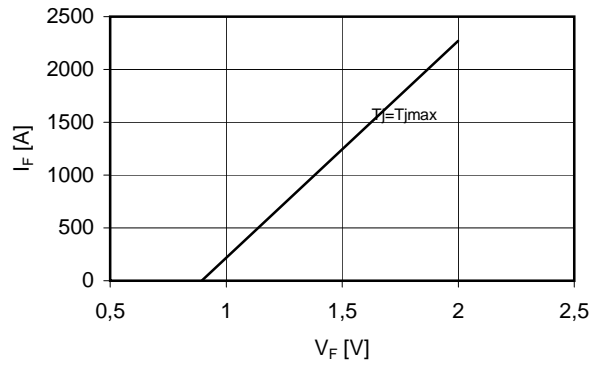

Thermal Impedance (j-c)

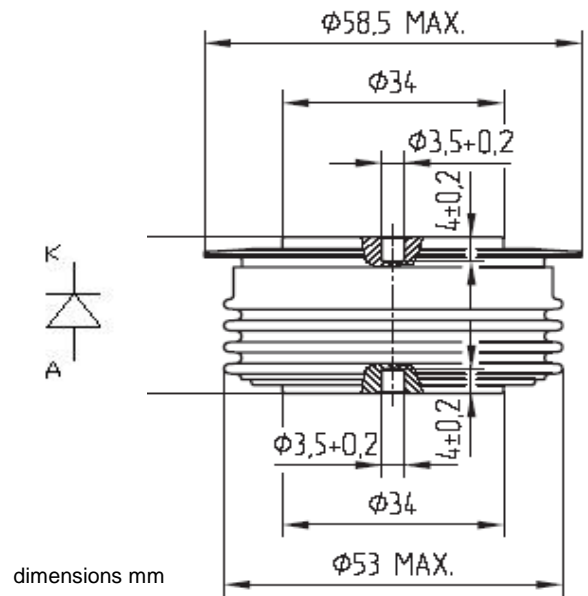
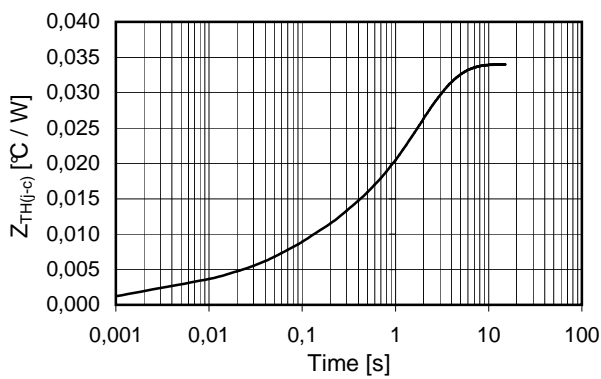

In the interest of product improvement Green Power Solutions reserves the right to change any specification given in this data sheet without notice.