

FERYSTER

TYPE

EDR2606-1

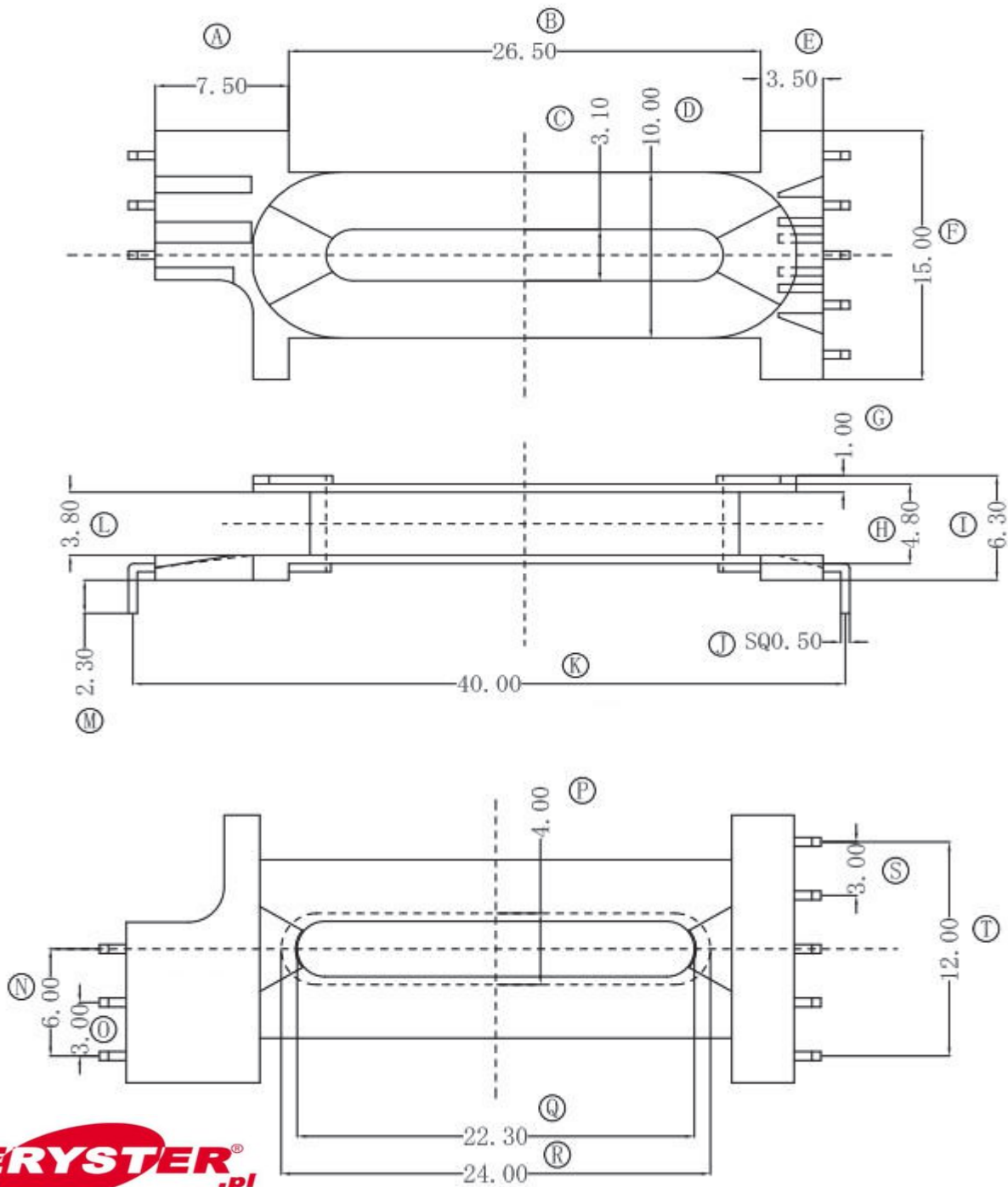

www.FERYSTER.pl

FERYSTER® spółka jawna B. i Z. Sobków
 PRODUCENT ELEMENTÓW INDUKCYJNYCH



IMPORT I DYSTRYBUCJA
 PHU REMAGAS

MODEL

EDR2609 5+3

MATERIAL

PHENOLIC

TEL

+48609591204

TOLERANCE

SCALE

DRAW BY 卢建

WWW

www.remagas.pl

0 < L ≤ 4 ±0.1
 4 < L ≤ 16 ±0.2

4/1

CHECK BY 田振奎

E-MAIL

remagas@remagas.pl

16 < L ≤ 63 ±0.3
 Pin pitch ±0.2

UNIT

MM

DATE

2013.01.15