

Heterojunction Bipolar Transistor Technology (InGaP HBT)

Broadband High Linearity Amplifier

The MMG3004NT1 is a General Purpose Amplifier that is internally prematched and designed for a broad range of Class A, small-signal, high linearity, general purpose applications. It is suitable for applications with frequencies from 400 to 2200 MHz such as Cellular, PCS, WLL, PHS, VHF, UHF, UMTS and general small-signal RF.

Features

- Frequency: 400-2200 MHz
- P1dB: 27 dBm @ 2140 MHz
- Small-Signal Gain: 16 dB @ 2140 MHz
- Third Order Output Intercept Point: 44 dBm @ 2140 MHz
- Single 5 Volt Supply
- Internally Prematched to 50 Ohms
- RoHS Compliant
- In Tape and Reel. T1 Suffix = 1000 Units per 16 mm, 13 inch Reel.

MMG3004NT1

**400-2200 MHz, 16 dB
27 dBm
InGaP HBT**

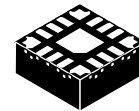

**CASE 1543-03
PQFN 5x5
PLASTIC**

Table 1. Typical Performance (1)

Characteristic	Symbol	900 MHz	1960 MHz	2140 MHz	Unit
Small-Signal Gain (S21)	G _p	19.5	16.5	16	dB
Input Return Loss (S11)	IRL	-7.5	-8	-8	dB
Output Return Loss (S22)	ORL	-10	-12	-12	dB
Power Output @1dB Compression	P1db	27	27	27	dBm
Third Order Output Intercept Point	IP3	44	44	44	dBm

1. V_{DC} = 5 Vdc, T_C = 25°C, 50 ohm system

Table 2. Maximum Ratings

Rating	Symbol	Value	Unit
Supply Voltage	V _{DC}	6	V
Supply Current	I _{DC}	400	mA
RF Input Power	P _{in}	18	dBm
Storage Temperature Range	T _{stg}	-65 to +150	°C
Junction Temperature (2)	T _J	150	°C

2. For reliable operation, the junction temperature should not exceed 150°C.

Table 3. Thermal Characteristics (V_{DC} = 5 Vdc, I_{DC} = 250 mA, T_C = 25°C)

Characteristic	Symbol	Value (3)	Unit
Thermal Resistance, Junction to Case	R _{θJC}	33	°C/W

3. Refer to AN1955, *Thermal Measurement Methodology of RF Power Amplifiers*. Go to <http://www.freescale.com/rf>.
Select Documentation/Application Notes - AN1955.

Table 4. Electrical Characteristics ($V_{DC} = 5$ Vdc, 2140 MHz, $T_C = 25^\circ\text{C}$, 50 ohm system, in Freescale Application Circuit)

Characteristic	Symbol	Min	Typ	Max	Unit
Small-Signal Gain (S21)	G_p	15	16	—	dB
Input Return Loss (S11)	IRL	—	-8	—	dB
Output Return Loss (S22)	ORL	—	-12	—	dB
Power Output @ 1dB Compression	P1dB	—	27	—	dBm
Third Order Output Intercept Point	IP3	—	44	—	dBm
Noise Figure	NF	—	3.4	—	dB
Supply Current (1)	I_{DC}	225	250	275	mA
Supply Voltage (1)	V_{DC}	—	5	—	V

1. For reliable operation, the junction temperature should not exceed 150°C .

Table 5. Functional Pin Description

Name	Pin Number	Description
RF _{in}	2, 3, 4	RF input for the power amplifier. This pin is DC-coupled and requires a DC-blocking series capacitor.
RF _{out} / V _{CC}	10, 11, 12	RF output for the power amplifier. This pin is DC-coupled and requires a DC-blocking series capacitor.
V _{CC}	14	Collector voltage supply.
V _{BA}	16	Bias voltage supply.
GND	Backside Center Metal	The center metal base of the PQFN package provides both DC and RF ground as well as heat sink contact for the power amplifier.

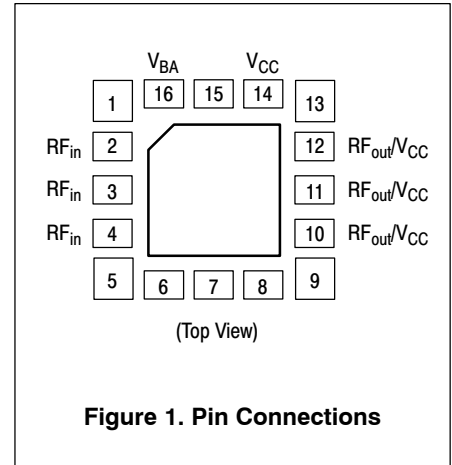

Table 6. ESD Protection Characteristics

Test Methodology	Class
Human Body Model (per JESD 22-A114)	1B (Minimum)
Machine Model (per EIA/JESD 22-A115)	A (Minimum)
Charge Device Model (per JESD 22-C101)	III (Minimum)

Table 7. Moisture Sensitivity Level

Test Methodology	Rating	Package Peak Temperature	Unit
Per JESD 22-A113, IPC/JEDEC J-STD-020	3	260	°C

50 OHM TYPICAL CHARACTERISTICS

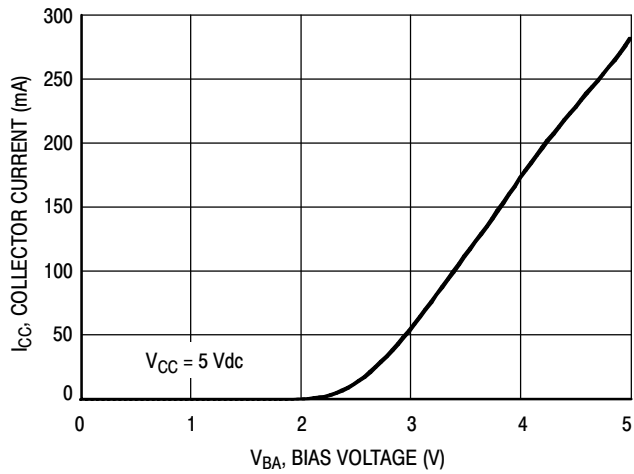
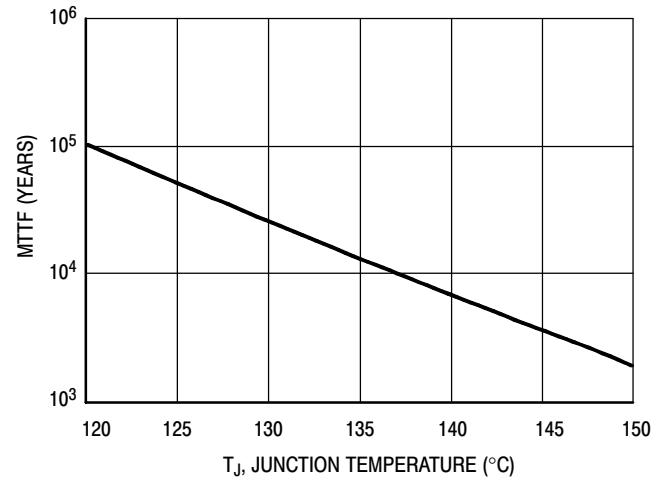

Figure 2. Collector Current versus Bias Voltage



NOTE: The MTTF is calculated with $V_{DC} = 5$ Vdc, $I_{DC} = 250$ mA

Figure 3. MTTF versus Junction Temperature

50 OHM APPLICATION CIRCUIT: 900 MHz

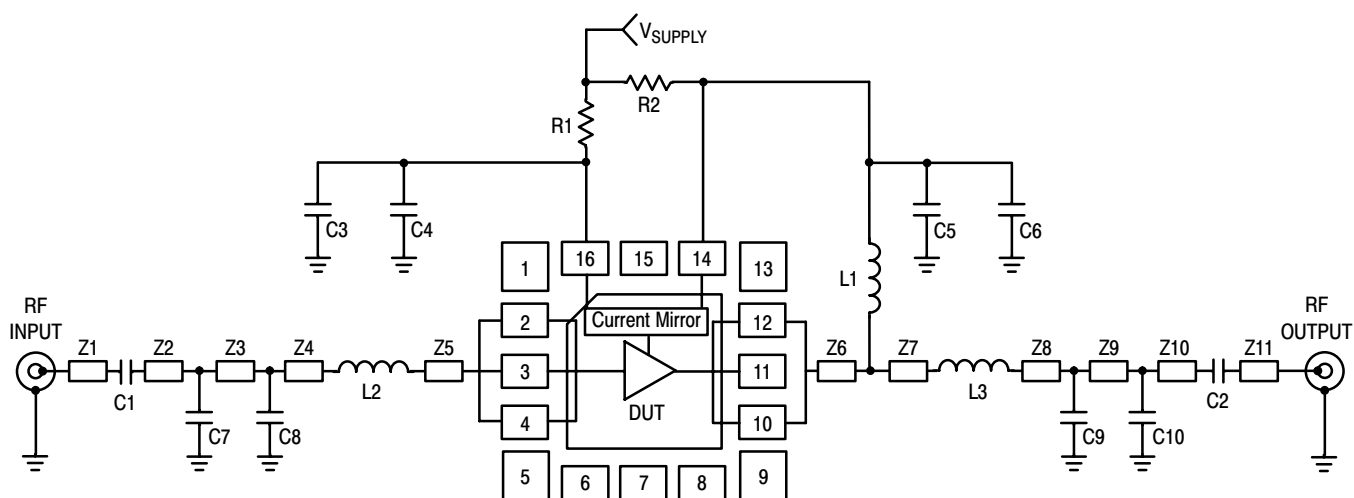

Z1, Z11	0.140" x 0.028" Microstrip	Z6	0.089" x 0.028" Microstrip
Z2, Z10	0.060" x 0.028" Microstrip	Z7	0.051" x 0.028" Microstrip
Z3	0.192" x 0.028" Microstrip	Z8	0.055" x 0.028" Microstrip
Z4	0.055" x 0.028" Microstrip	Z9	0.112" x 0.028" Microstrip
Z5	0.084" x 0.028" Microstrip	PCB	Isola FR408, 0.014", $\epsilon_r = 3.7$

Figure 4. 50 Ohm Test Circuit Schematic

Table 8. 50 Ohm Test Circuit Component Designations and Values

Part	Description	Part Number	Manufacturer
C1, C2	15 pF Chip Capacitors	ECUV1H150JCV	Panasonic
C3, C5	0.01 μ F Chip Capacitors	C0603C103J5RAC	Kemet
C4, C6	0.1 μ F Chip Capacitors	C0603C104J5RAC	Kemet
C7, C8	2.2 pF Chip Capacitors	06035J2R2BS	AVX
C9, C10	1.8 pF Chip Capacitors	06035J1R8BS	AVX
L1	33 nH Chip Inductor	LL1608-FSL33NJ	Toko
L2, L3	3.9 nH Chip Inductors	LL1608-FSL3N9S	Toko
R1	22 Ω , 1/10 W Chip Resistor	CRCW060322R0FKEA	Vishay
R2	0 Ω , 1/10 W Chip Resistor	CRCW06030000FKEA	Vishay

50 OHM APPLICATION CIRCUIT: 900 MHz

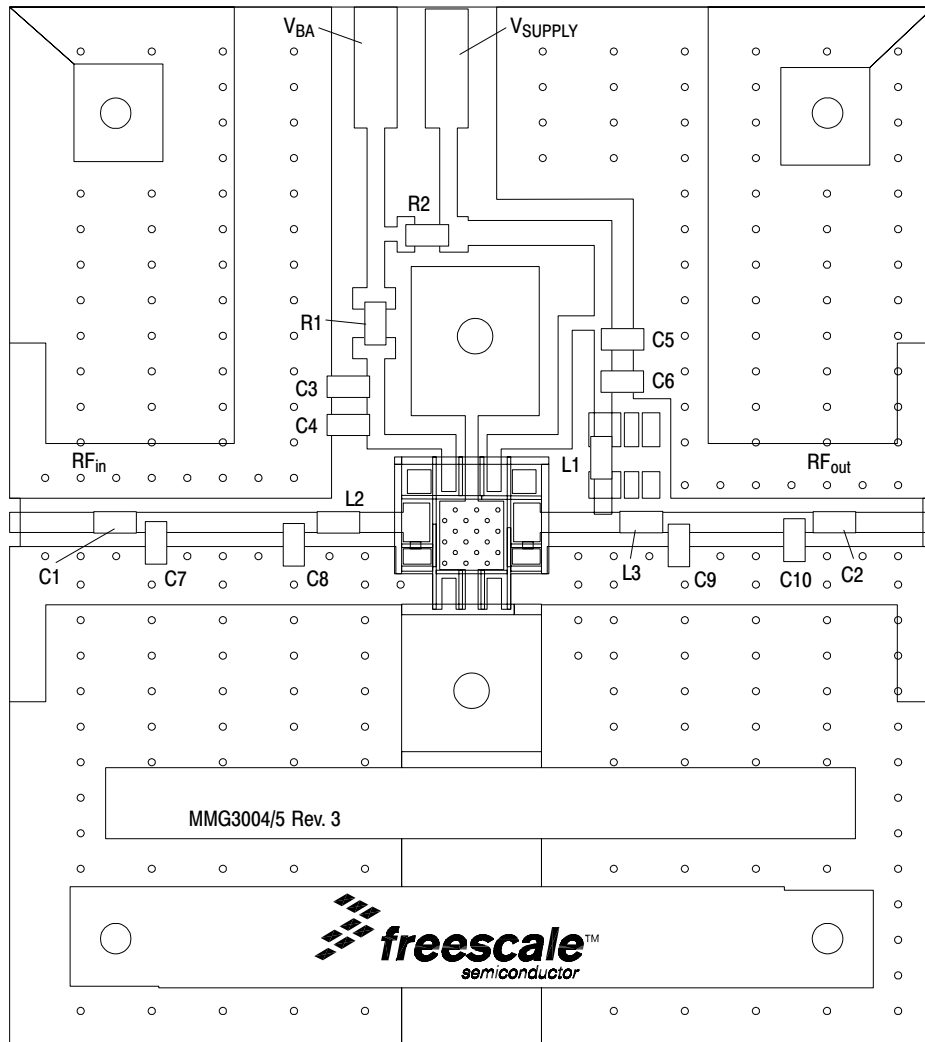

Figure 5. 50 Ohm Test Circuit Component Layout

50 OHM TYPICAL CHARACTERISTICS: 900 MHz

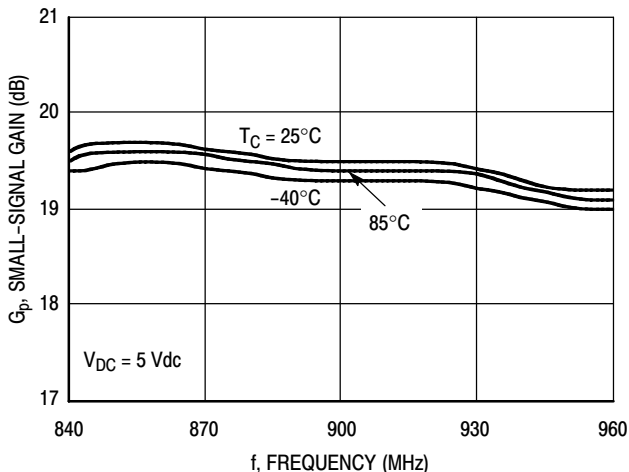

Figure 6. Small-Signal Gain (S21) versus Frequency

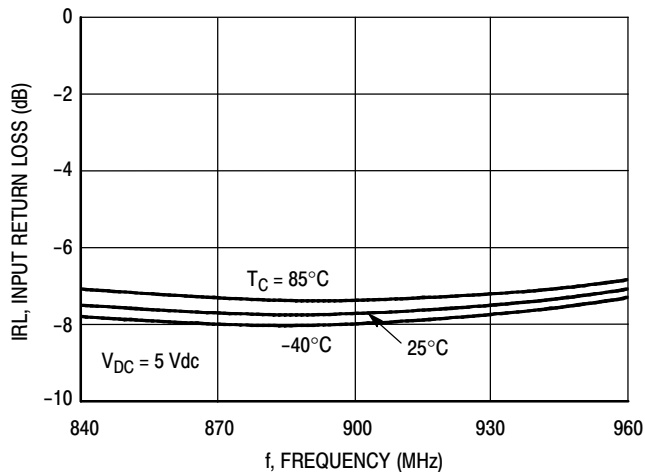

Figure 7. Input Return Loss (S11) versus Frequency

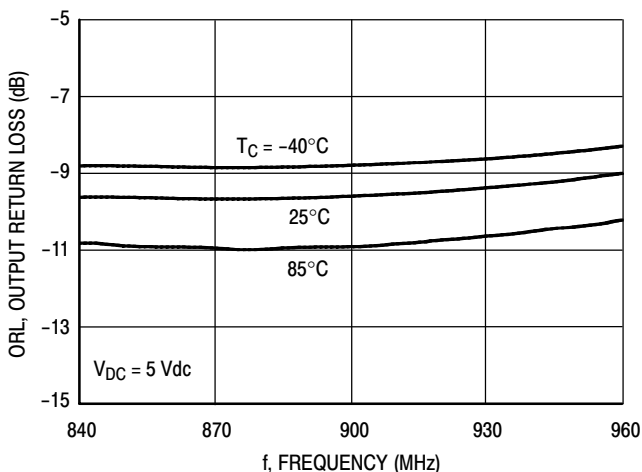

Figure 8. Output Return Loss (S22) versus Frequency

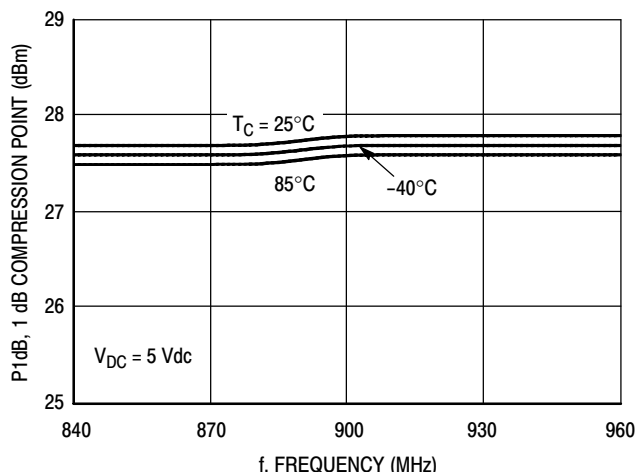

Figure 9. P1dB versus Frequency

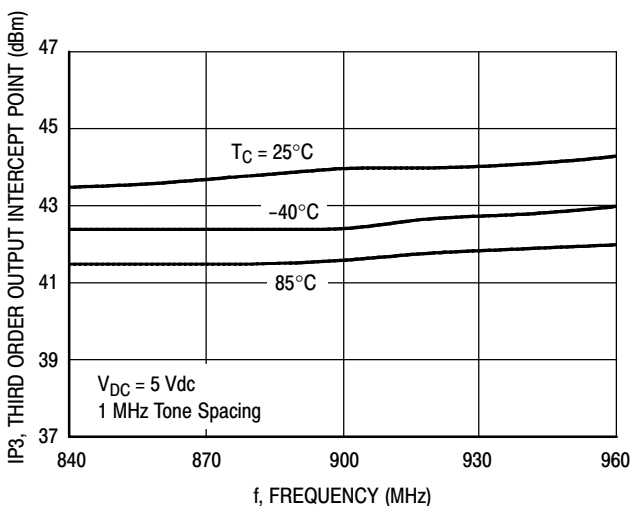

Figure 10. Third Order Output Intercept Point versus Frequency

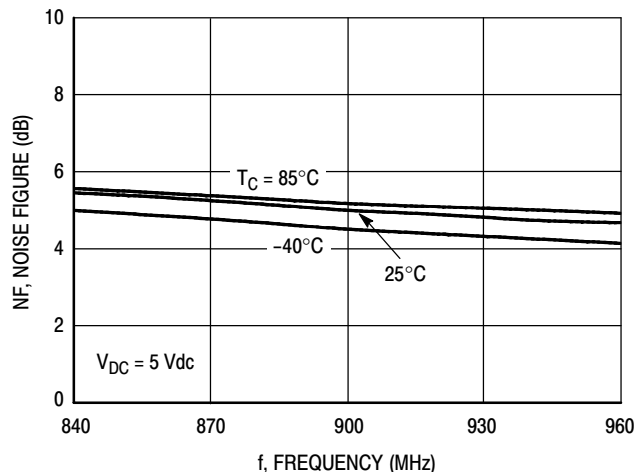

Figure 11. Noise Figure versus Frequency

50 OHM TYPICAL CHARACTERISTICS: 900 MHz

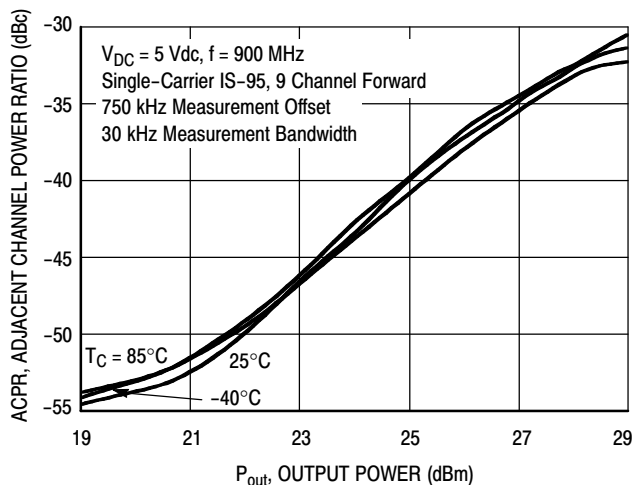

Figure 12. IS-95 Adjacent Channel Power Ratio versus Output Power

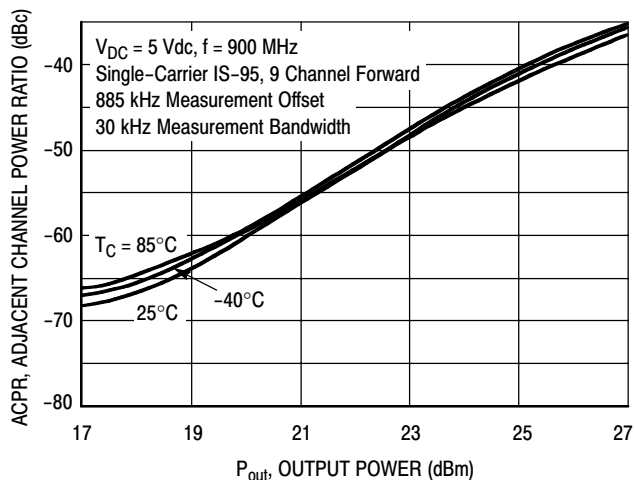

Figure 13. IS-95 Adjacent Channel Power Ratio versus Output Power

50 OHM APPLICATION CIRCUIT: 1900-2200 MHz

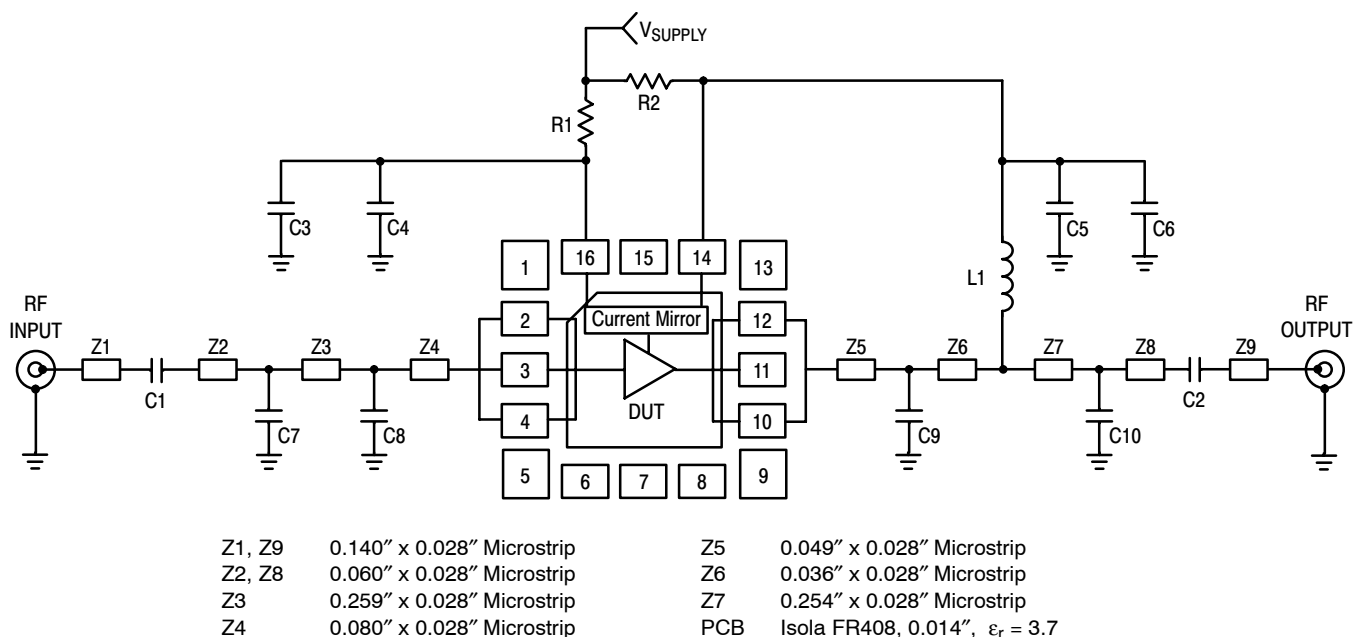

Figure 14. 50 Ohm Test Circuit Schematic

Table 9. 50 Ohm Test Circuit Component Designations and Values

Part	Description	Part Number	Manufacturer
C1, C2	15 pF Chip Capacitors	ECUV1H150JCV	Panasonic
C3, C5	0.01 μ F Chip Capacitors	C0603C103J5RAC	Kemet
C4, C6	0.1 μ F Chip Capacitors	C0603C104J5RAC	Kemet
C7, C10	0.5 pF Chip Capacitors	06035J0R5BS	AVX
C8	2.7 pF Chip Capacitor	06035J2R7BS	AVX
C9	0.8 pF Chip Capacitor	06035J0R8BS	AVX
L1	33 nH Chip Inductor	LL1608-FSL33NJ	Toko
R1	22 Ω , 1/10 W Chip Resistor	CRCW060322R0FKEA	Vishay
R2	0 Ω , 1/10 W Chip Resistor	CRCW06030000FKEA	Vishay

50 OHM APPLICATION CIRCUIT: 1900-2200 MHz

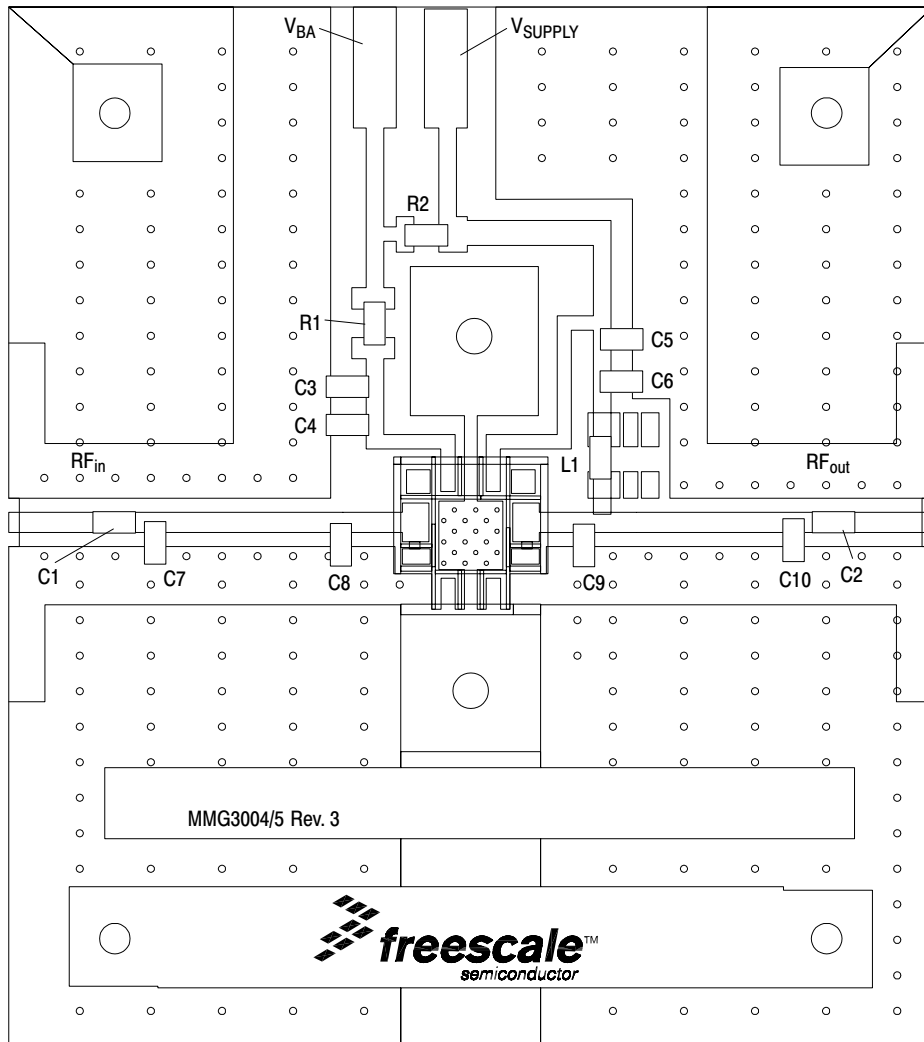

Figure 15. 50 Ohm Test Circuit Component Layout

50 OHM TYPICAL CHARACTERISTICS: 1900-2200 MHz

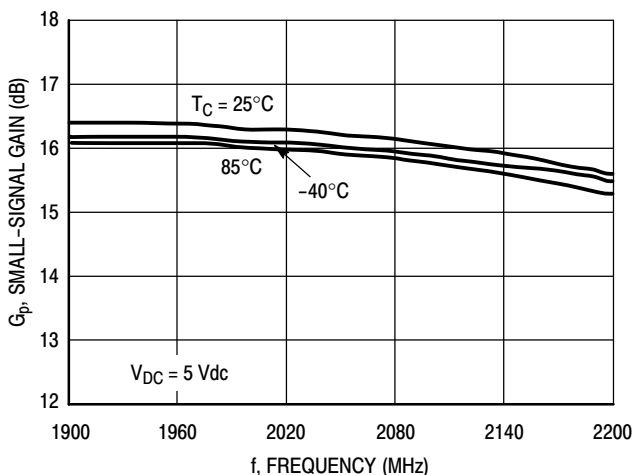

Figure 16. Small-Signal Gain (S21) versus Frequency

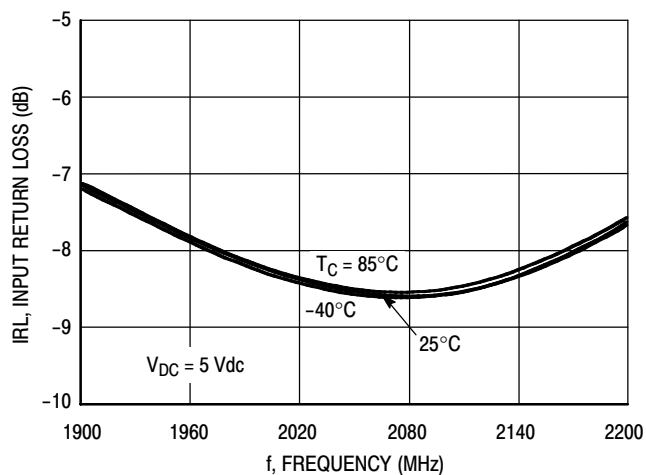

Figure 17. Input Return Loss (S11) versus Frequency

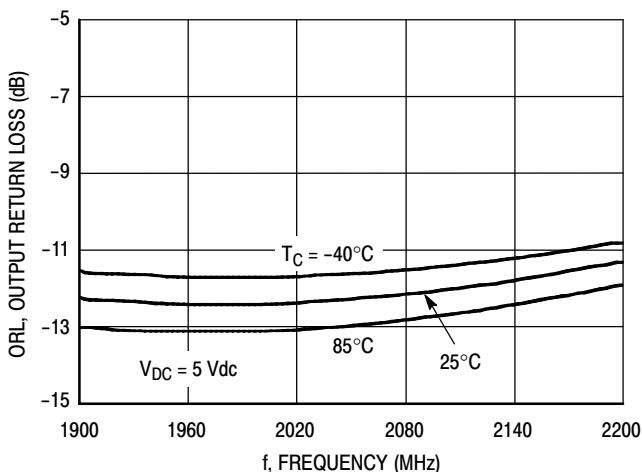

Figure 18. Output Return Loss (S22) versus Frequency

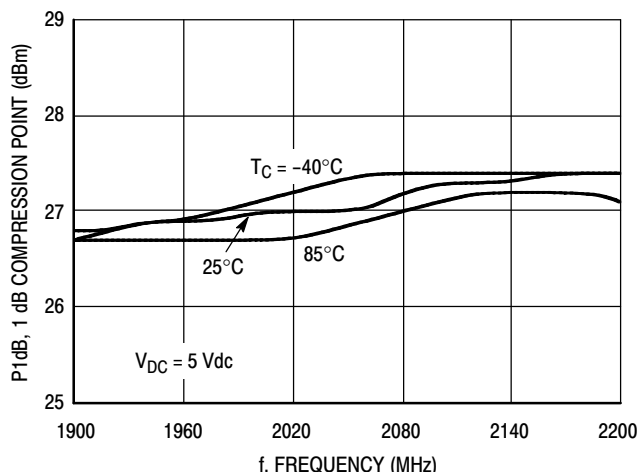

Figure 19. P1dB versus Frequency

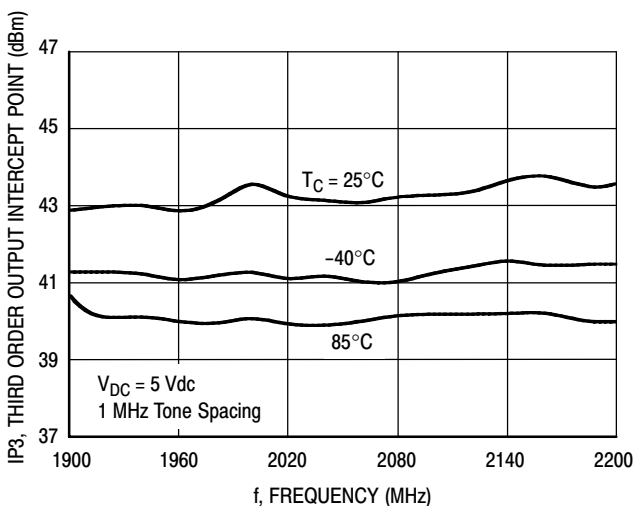

Figure 20. Third Order Output Intercept Point versus Frequency

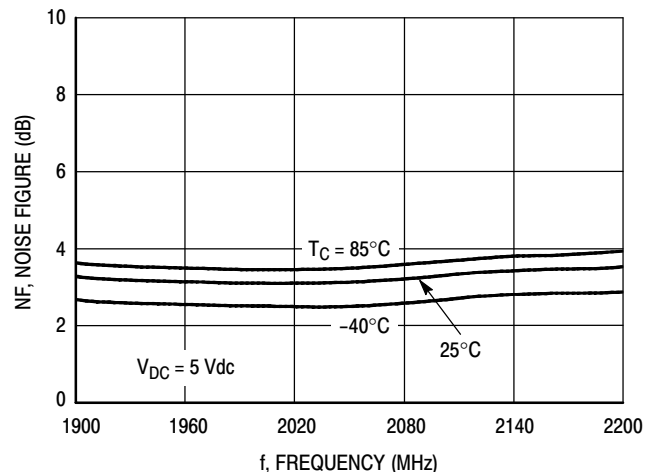

Figure 21. Noise Figure versus Frequency

50 OHM TYPICAL CHARACTERISTICS: 1900-2200 MHz

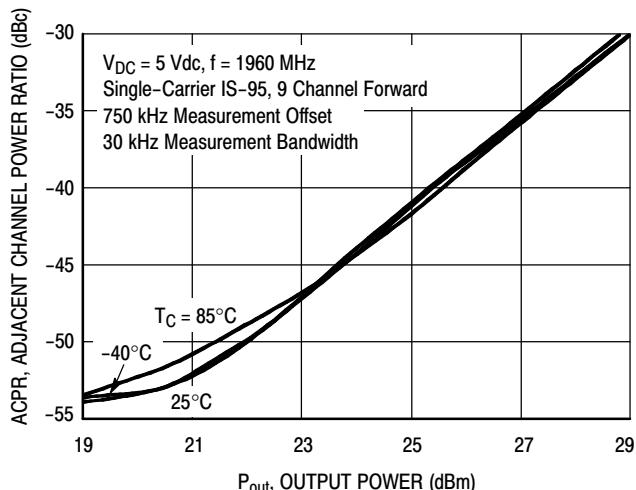

Figure 22. IS-95 Adjacent Channel Power Ratio versus Output Power

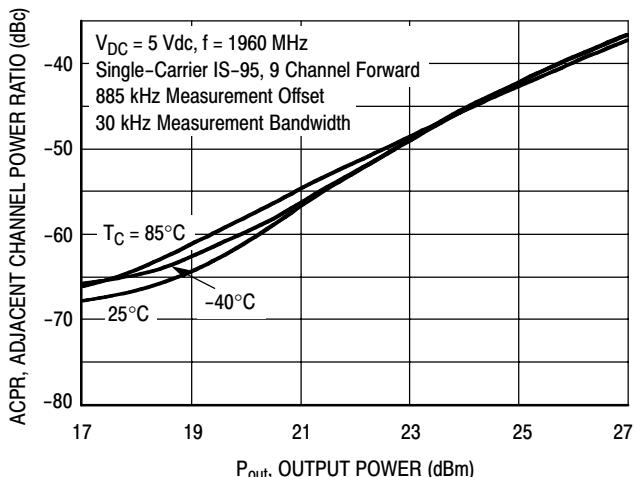

Figure 23. IS-95 Adjacent Channel Power Ratio versus Output Power

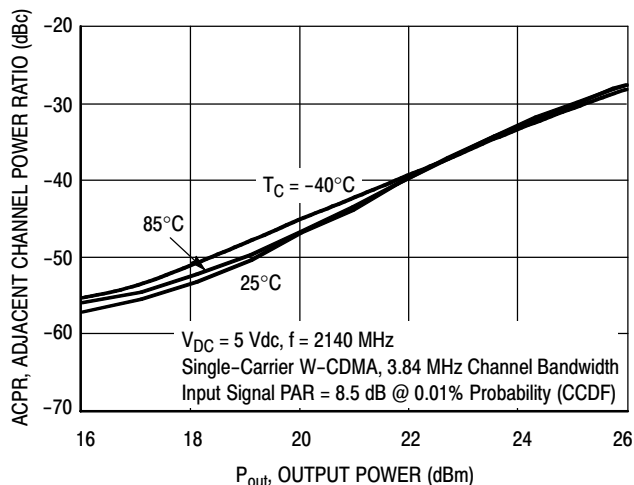

Figure 24. Single-Carrier W-CDMA Adjacent Channel Power Ratio versus Output Power

50 OHM TYPICAL CHARACTERISTICS

Table 10. Common Emitter S-Parameters ($V_{DC} = 5 \text{ Vdc}$, $I_{DC} = 250 \text{ mA}$, $T_C = 25^\circ\text{C}$, 50 Ohm System)

f MHz	S ₁₁		S ₂₁		S ₁₂		S ₂₂	
	S ₁₁	∠ φ	S ₂₁	∠ φ	S ₁₂	∠ φ	S ₂₂	∠ φ
400	0.62780	-155.59	7.75028	138.19	0.01341	-20.61	0.73308	177.59
425	0.64110	-156.56	7.52200	135.93	0.01318	-18.49	0.73263	177.05
450	0.65775	-157.61	7.40177	133.81	0.01297	-16.33	0.73058	176.51
475	0.67009	-158.60	7.20037	131.68	0.01282	-14.50	0.72961	176.03
500	0.68313	-159.63	7.05567	129.69	0.01265	-12.50	0.72804	175.54
525	0.69585	-160.59	6.91538	127.76	0.01255	-10.52	0.72718	175.02
550	0.70558	-161.46	6.69940	125.72	0.01251	-8.66	0.72650	174.46
575	0.71811	-162.43	6.60437	123.98	0.01243	-6.84	0.72500	173.90
600	0.72694	-163.35	6.42427	122.18	0.01240	-5.19	0.72458	173.43
625	0.73704	-164.30	6.29327	120.47	0.01238	-3.35	0.72338	172.92
650	0.74634	-165.20	6.17990	118.78	0.01241	-1.68	0.72241	172.43
675	0.75277	-166.03	5.99028	117.13	0.01246	-0.10	0.72250	171.98
700	0.76214	-166.98	5.91391	115.54	0.01249	1.32	0.72135	171.44
725	0.76874	-167.82	5.76815	114.00	0.01254	2.86	0.72103	170.97
750	0.77561	-168.72	5.64770	112.56	0.01262	4.27	0.72003	170.51
775	0.78327	-169.54	5.56291	111.09	0.01272	5.73	0.71950	170.03
800	0.78772	-170.26	5.40401	109.64	0.01285	7.01	0.71888	169.54
825	0.79476	-171.12	5.33575	108.25	0.01299	8.22	0.71803	169.01
850	0.79893	-171.88	5.21557	106.88	0.01314	9.31	0.71838	168.59
875	0.80421	-172.62	5.09417	105.61	0.01326	10.44	0.71707	168.13
900	0.80983	-173.40	5.04484	104.35	0.01340	11.44	0.71668	167.64
925	0.81256	-174.09	4.90083	102.95	0.01357	12.52	0.71611	167.14
950	0.81780	-174.81	4.83208	101.78	0.01377	13.37	0.71547	166.62
975	0.82118	-175.53	4.75850	100.63	0.01398	14.40	0.71514	166.17
1000	0.82354	-176.19	4.64462	99.41	0.01421	15.20	0.71375	165.68
1025	0.82863	-176.93	4.59813	98.27	0.01449	15.97	0.71292	165.18
1050	0.82994	-177.51	4.47959	97.05	0.01482	16.45	0.71160	164.72
1075	0.83369	-178.12	4.41800	96.02	0.01512	16.27	0.71100	164.34
1100	0.83728	-178.76	4.36819	95.02	0.01522	16.04	0.71111	163.96
1125	0.83914	-179.35	4.25589	93.92	0.01522	16.13	0.71104	163.46
1150	0.84333	-179.99	4.21812	92.91	0.01532	16.71	0.71144	162.96
1175	0.84582	179.42	4.14782	91.86	0.01540	17.23	0.71102	162.41
1200	0.84730	178.80	4.07433	90.84	0.01549	17.85	0.71091	161.96
1225	0.85017	178.20	4.03089	89.88	0.01563	18.56	0.71058	161.46
1250	0.85104	177.63	3.94928	88.92	0.01581	19.15	0.70945	160.92
1275	0.85363	177.01	3.91182	87.97	0.01603	19.78	0.70911	160.44
1300	0.85515	176.48	3.84948	86.97	0.01623	20.21	0.70802	159.92
1325	0.85660	175.94	3.79124	86.09	0.01644	20.62	0.70758	159.44
1350	0.85919	175.39	3.75583	85.18	0.01665	21.10	0.70645	158.93
1375	0.85982	174.86	3.68725	84.24	0.01685	21.41	0.70534	158.44
1400	0.86102	174.26	3.65116	83.37	0.01708	21.83	0.70492	157.95
1425	0.86270	173.77	3.60736	82.44	0.01733	22.12	0.70407	157.43
1450	0.86382	173.26	3.55564	81.56	0.01754	22.31	0.70310	156.95
1475	0.86525	172.73	3.51922	80.69	0.01778	22.70	0.70185	156.45

(continued)

50 OHM TYPICAL CHARACTERISTICS

Table 10. Common Emitter S-Parameters ($V_{DC} = 5 \text{ Vdc}$, $I_{DC} = 250 \text{ mA}$, $T_C = 25^\circ\text{C}$, 50 Ohm System) (continued)

f MHz	S ₁₁		S ₂₁		S ₁₂		S ₂₂	
	S ₁₁	∠ φ	S ₂₁	∠ φ	S ₁₂	∠ φ	S ₂₂	∠ φ
1500	0.86447	171.75	3.49706	79.68	0.01815	22.78	0.69775	156.18
1525	0.86543	171.19	3.46774	78.76	0.01841	22.92	0.69678	155.64
1550	0.86646	170.67	3.42587	77.92	0.01868	23.04	0.69558	155.13
1575	0.86663	170.18	3.38624	77.08	0.01889	23.19	0.69453	154.61
1600	0.86864	169.65	3.35249	76.23	0.01916	23.38	0.69264	154.06
1625	0.86848	169.14	3.31471	75.38	0.01940	23.47	0.69185	153.54
1650	0.86907	168.58	3.28145	74.52	0.01966	23.55	0.69110	153.02
1675	0.86995	168.06	3.24680	73.68	0.01990	23.70	0.68960	152.47
1700	0.86908	167.55	3.21301	72.89	0.02016	23.85	0.68912	152.02
1725	0.87075	166.99	3.17917	72.07	0.02043	23.94	0.68700	151.51
1750	0.87075	166.48	3.14872	71.28	0.02072	23.94	0.68638	151.05
1775	0.87095	165.94	3.11816	70.46	0.02101	24.02	0.68533	150.57
1800	0.87210	165.38	3.08624	69.66	0.02127	24.02	0.68377	150.09
1825	0.87206	164.86	3.05732	68.88	0.02156	24.07	0.68284	149.66
1850	0.87291	164.26	3.02693	68.07	0.02183	24.07	0.68136	149.22
1875	0.87225	163.73	2.99956	67.29	0.02214	24.03	0.68073	148.79
1900	0.87269	163.18	2.97218	66.53	0.02241	24.07	0.67941	148.37
1925	0.87341	162.62	2.94317	65.76	0.02272	24.05	0.67817	147.93
1950	0.87288	162.11	2.91922	65.01	0.02300	24.10	0.67684	147.54
1975	0.87403	161.54	2.88985	64.24	0.02333	23.99	0.67500	147.15
2000	0.87359	160.98	2.86616	63.49	0.02366	23.91	0.67393	146.75
2025	0.87242	160.38	2.84227	62.70	0.02397	23.80	0.67298	146.42
2050	0.87347	159.78	2.81763	61.98	0.02429	23.70	0.67159	146.04
2075	0.87337	159.25	2.79570	61.26	0.02465	23.66	0.67018	145.69
2100	0.87327	158.66	2.77239	60.53	0.02498	23.49	0.66901	145.36
2125	0.87318	158.11	2.75232	59.81	0.02536	23.32	0.66790	145.01
2150	0.87233	157.55	2.73039	59.07	0.02571	23.11	0.66702	144.69
2175	0.87291	156.95	2.70958	58.40	0.02602	22.93	0.66610	144.37
2200	0.87284	156.41	2.69236	57.69	0.02636	22.73	0.66519	144.03
2225	0.87305	155.87	2.67297	57.01	0.02672	22.55	0.66417	143.67
2250	0.87252	155.28	2.65614	56.29	0.02709	22.23	0.66378	143.30
2275	0.87193	154.76	2.63741	55.58	0.02744	22.01	0.66344	142.95
2300	0.87178	154.15	2.62034	54.89	0.02777	21.74	0.66387	142.57
2325	0.87159	153.64	2.60593	54.19	0.02812	21.52	0.66363	142.19
2350	0.87191	153.13	2.59024	53.50	0.02850	21.34	0.66365	141.75
2375	0.87202	152.60	2.57507	52.78	0.02891	21.08	0.66346	141.32
2400	0.87117	152.09	2.55841	52.08	0.02926	20.77	0.66342	140.87
2425	0.87077	151.53	2.54515	51.37	0.02967	20.45	0.66386	140.39
2450	0.87026	151.02	2.53215	50.65	0.03007	20.15	0.66405	139.92
2475	0.87003	150.54	2.51806	49.95	0.03047	19.77	0.66432	139.41
2500	0.86985	150.02	2.50328	49.24	0.03087	19.40	0.66490	138.85
2525	0.86940	149.49	2.49003	48.49	0.03126	18.98	0.66538	138.34
2550	0.86918	148.98	2.47736	47.77	0.03167	18.61	0.66582	137.78
2575	0.86921	148.48	2.46415	47.02	0.03208	18.11	0.66531	137.21

(continued)

50 OHM TYPICAL CHARACTERISTICS

Table 10. Common Emitter S-Parameters ($V_{DC} = 5 \text{ Vdc}$, $I_{DC} = 250 \text{ mA}$, $T_C = 25^\circ\text{C}$, 50 Ohm System) (continued)

f MHz	S ₁₁		S ₂₁		S ₁₂		S ₂₂	
	S ₁₁	∠ φ	S ₂₁	∠ φ	S ₁₂	∠ φ	S ₂₂	∠ φ
2600	0.86804	147.97	2.45098	46.28	0.03246	17.66	0.66588	136.62
2625	0.86808	147.46	2.43657	45.54	0.03287	17.21	0.66553	136.01
2650	0.86755	146.99	2.42271	44.82	0.03328	16.67	0.66525	135.46
2675	0.86741	146.47	2.41111	44.06	0.03360	16.15	0.66520	134.87
2700	0.86769	145.97	2.39656	43.31	0.03402	15.56	0.66461	134.26
2725	0.86693	145.47	2.38409	42.57	0.03438	15.04	0.66448	133.68
2750	0.86730	144.92	2.37136	41.82	0.03473	14.40	0.66407	133.13
2775	0.86724	144.42	2.35811	41.07	0.03504	13.77	0.66312	132.57
2800	0.86702	143.87	2.34590	40.30	0.03530	13.25	0.66208	132.00
2825	0.86694	143.37	2.33197	39.55	0.03566	12.69	0.66088	131.39
2850	0.86602	142.83	2.32062	38.80	0.03594	12.05	0.66087	130.80
2875	0.86701	142.28	2.30727	38.05	0.03623	11.45	0.65952	130.25
2900	0.86649	141.70	2.29559	37.30	0.03650	10.82	0.65833	129.72
2925	0.86653	141.16	2.28517	36.51	0.03678	10.22	0.65713	129.15
2950	0.86661	140.59	2.27190	35.74	0.03700	9.61	0.65548	128.55
2975	0.86565	140.01	2.26115	34.97	0.03725	9.07	0.65458	127.97
3000	0.86627	139.42	2.24868	34.20	0.03747	8.51	0.65272	127.41

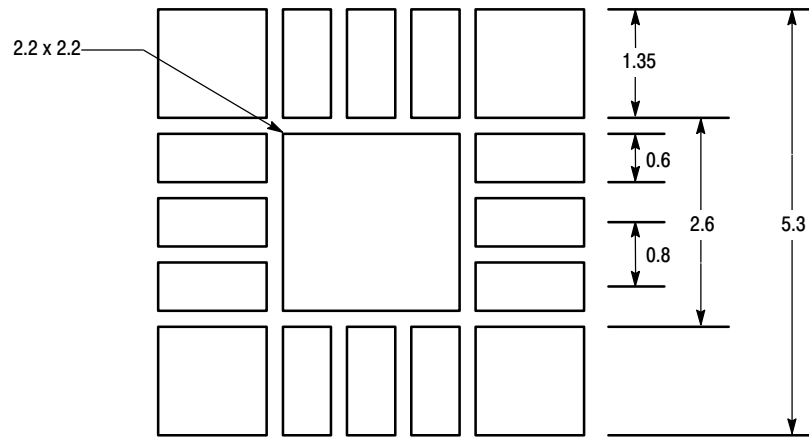

NOTES:

1. THERMAL AND RF GROUNDING CONSIDERATIONS SHOULD BE USED IN PCB LAYOUT DESIGN.
2. DEPENDING ON PCB DESIGN RULES, AS MANY VIAS AS POSSIBLE SHOULD BE PLACED ON THE BACKSIDE CENTER METAL GROUND LANDING PATTERN.
3. REFER TO FREESCALE APPLICATION NOTE AN2467 FOR ADDITIONAL PQFN PCB GUIDELINES.

Figure 25. Recommended Mounting Configuration

PACKAGE DIMENSIONS

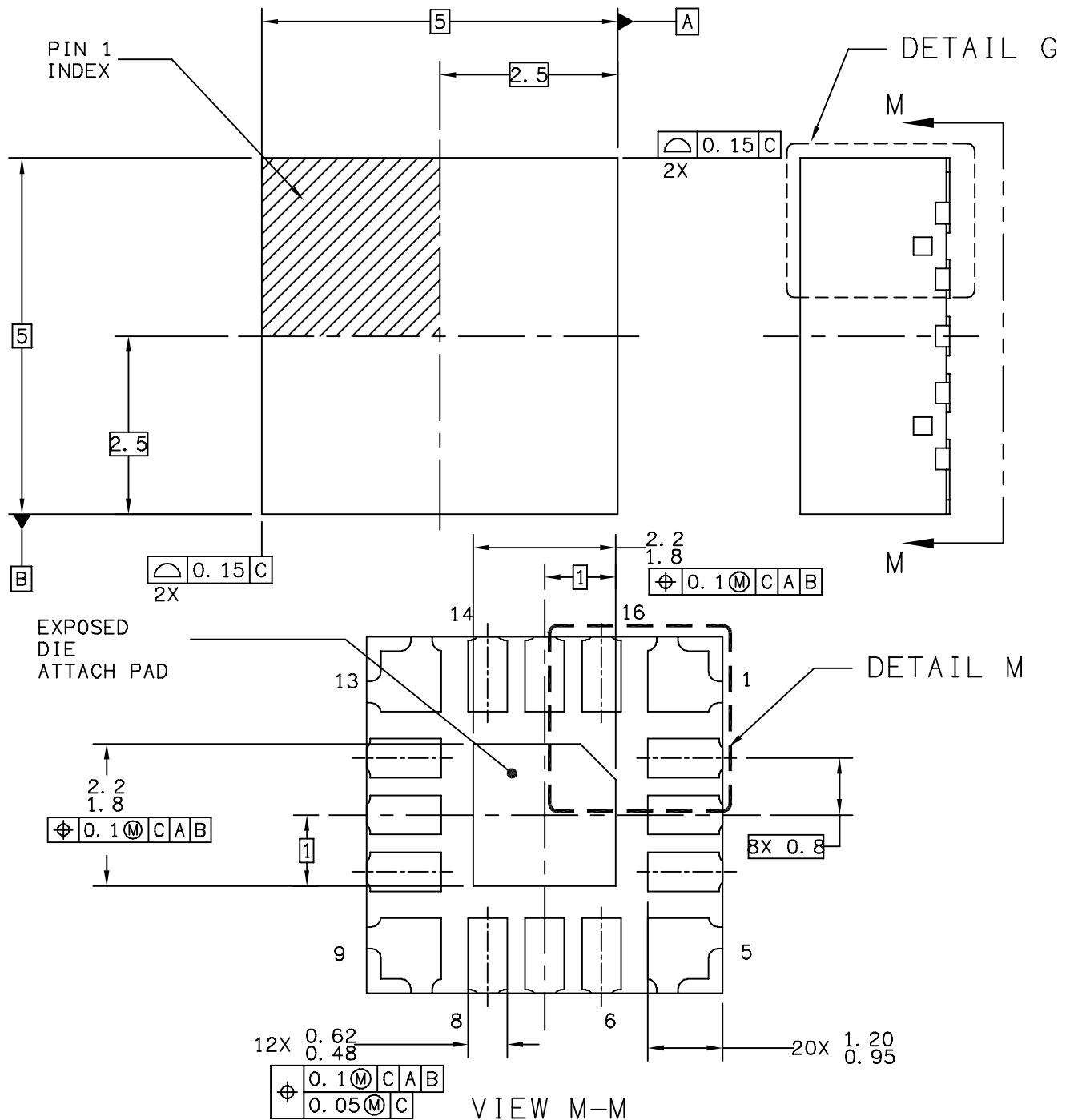

© FREESCALE SEMICONDUCTOR, INC. ALL RIGHTS RESERVED.	MECHANICAL OUTLINE		PRINT VERSION NOT TO SCALE	
	TITLE: THERMALLY ENHANCED POWER QUAD FLAT NON-LEADED PACKAGE (PQFN) 16 TERMINAL, 0.8 PITCH (5X5X2.1) CASE-OUTLINE		DOCUMENT NO: 98ARL10575D CASE NUMBER: 1543-03 STANDARD: JEDEC M0-251	REV: C 31 OCT 2006

MMG3004NT1

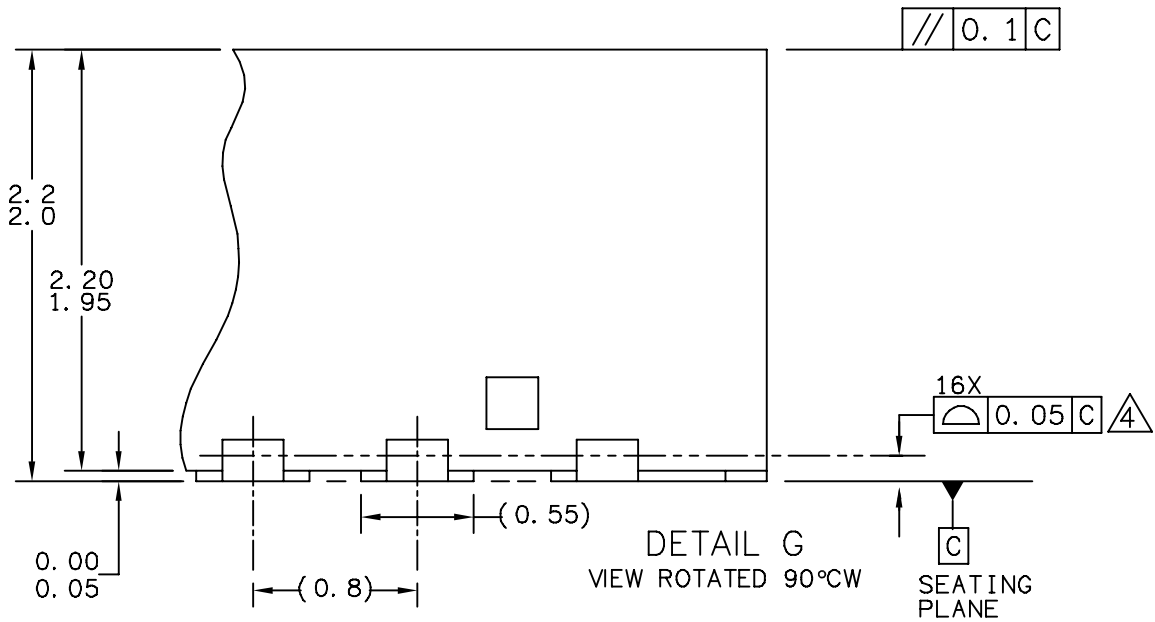
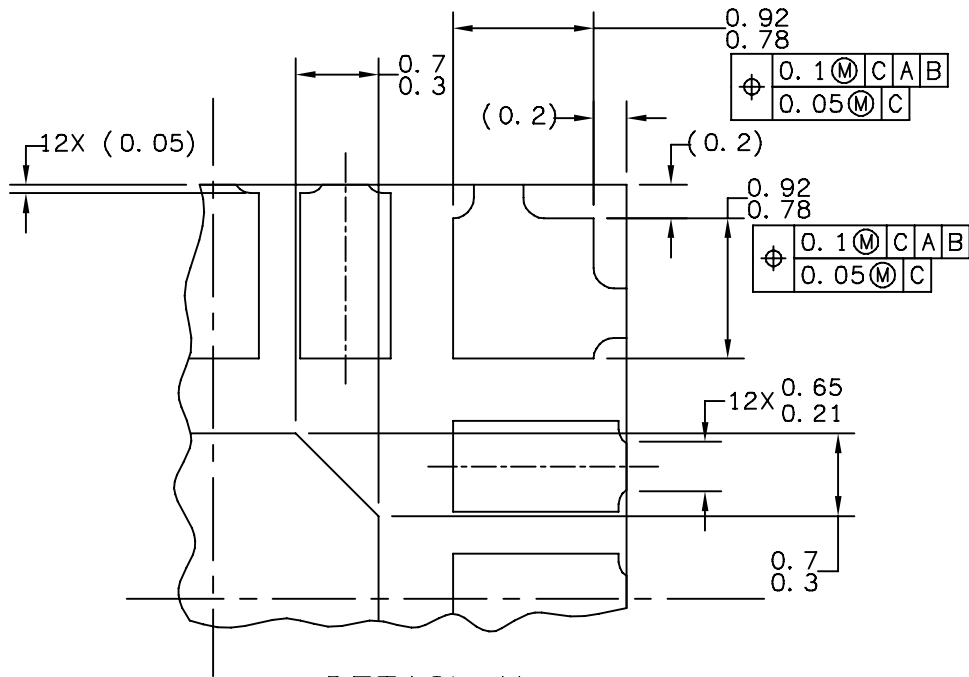

© FREESCALE SEMICONDUCTOR, INC. ALL RIGHTS RESERVED.	MECHANICAL OUTLINE	PRINT VERSION NOT TO SCALE	
TITLE:THERMALLY ENHANCED POWER QUAD FLAT NON-LEADED PACKAGE (PQFN) 16 TERMINAL, 0.8 PITCH (5X5X2.1) CASE-OUTLINE	DOCUMENT NO: 98ARL10575D	REV: C	
	CASE NUMBER: 1543-03	31 OCT 2006	
	STANDARD: JEDEC MO-251		

NOTES:

1. ALL DIMENSIONS ARE IN MILLIMETERS.
2. DIMENSIONING AND TOLERANCING PER ASME Y14.5M-1994.
3. THE COMPLETE JEDEC DESIGNATOR FOR THIS PACKAGE IS: HF-PQFN.
4.  COPLANARITY APPLIES TO LEADS AND DIE ATTACH PAD.
5. MINIMUM METAL GAP SHOULD BE 0.25MM.

© FREESCALE SEMICONDUCTOR, INC. ALL RIGHTS RESERVED.	MECHANICAL OUTLINE	PRINT VERSION NOT TO SCALE	
TITLE:THERMALLY ENHANCED POWER QUAD FLAT NON-LEADED PACKAGE (PQFN) 16 TERMINAL, 0.8 PITCH (5X5X2.1) CASE-OUTLINE	DOCUMENT NO: 98ARL10575D	REV: C	
	CASE NUMBER: 1543-03	31 OCT 2006	
	STANDARD: JEDEC M0-251		

PRODUCT DOCUMENTATION

Refer to the following documents to aid your design process.

Application Notes

- AN1955: Thermal Measurement Methodology of RF Power Amplifiers
- AN3100: General Purpose Amplifier Biasing

REVISION HISTORY

The following table summarizes revisions to this document.

Revision	Date	Description
2	Mar. 2007	<ul style="list-style-type: none">• Replaced Case Outline 1543-02 with updated 1543-03, Issue C, p. 1, 16-18• Added V_{CC} callout to Pin Connections 10, 11, and 12 in Fig. 1, Pin Connections, p. 3• Updated Part Numbers in Table 8, Component Designations and Values, 900 MHz, to RoHS compliant part numbers, p. 5• Corrected circuit board callouts, V_p to V_{BA} and V_{CC} to V_{SUPPLY}, Fig. 5, 50 Ohm Test Circuit Component Layout, 900 MHz, p. 6• Removed I_{DC} value due to its variability over temperature, Figs. 12-13, IS-95 Adjacent Channel Power Ratio versus Output Power, 900 MHz, p. 8• Updated Part Numbers in Table 9, Component Designations and Values, 1900-2200 MHz, to RoHS compliant part numbers, p. 9• Corrected circuit board callouts, V_p to V_{BA} and V_{CC} to V_{SUPPLY}, Fig. 15, 50 Ohm Test Circuit Component Layout, 1900-2200 MHz, p. 10• Removed I_{DC} value due to its variability over temperature, Figs. 22-23, IS-95 Adjacent Channel Power Ratio versus Output Power, 1900-2200 MHz, and Fig. 24, Single-Carrier W-CDMA Adjacent Channel Power Ratio versus Output Power, 1900-2200 MHz, p. 12• Replaced Table 10, S-Parameters, p. 13-15• Added Product Documentation and Revision History, p. 19
3	Mar. 2008	<ul style="list-style-type: none">• Corrected Tape and Reel information from 12 mm, 7 inch Reel to 16 mm, 13 inch Reel, p. 1• Removed Footnote 2, Continuous voltage and current applied to device, from Table 2, Maximum Ratings, p. 1• Corrected Fig. 24, Single-Carrier W-CDMA Adjacent Channel Power Ratio versus Output Power y-axis (ACPR) unit of measure to dBc, p. 12• Corrected S-Parameter table frequency column label to read "MHz" versus "GHz" and corrected frequency values from GHz to MHz, p. 13, 14, 15

How to Reach Us:

Home Page:

www.freescale.com

Web Support:

<http://www.freescale.com/support>

USA/Europe or Locations Not Listed:

Freescale Semiconductor, Inc.
Technical Information Center, EL516
2100 East Elliot Road
Tempe, Arizona 85284
+1-800-521-6274 or +1-480-768-2130
www.freescale.com/support

Europe, Middle East, and Africa:

Freescale Halbleiter Deutschland GmbH
Technical Information Center
Schatzbogen 7
81829 Muenchen, Germany
+44 1296 380 456 (English)
+46 8 52200080 (English)
+49 89 92103 559 (German)
+33 1 69 35 48 48 (French)
www.freescale.com/support

Japan:

Freescale Semiconductor Japan Ltd.
Headquarters
ARCO Tower 15F
1-8-1, Shimo-Meguro, Meguro-ku,
Tokyo 153-0064
Japan
0120 191014 or +81 3 5437 9125
support.japan@freescale.com

Asia/Pacific:

Freescale Semiconductor Hong Kong Ltd.
Technical Information Center
2 Dai King Street
Tai Po Industrial Estate
Tai Po, N.T., Hong Kong
+800 2666 8080
support.asia@freescale.com

For Literature Requests Only:

Freescale Semiconductor Literature Distribution Center
P.O. Box 5405
Denver, Colorado 80217
1-800-441-2447 or 303-675-2140
Fax: 303-675-2150
LDCForFreescaleSemiconductor@hibbertgroup.com

Information in this document is provided solely to enable system and software implementers to use Freescale Semiconductor products. There are no express or implied copyright licenses granted hereunder to design or fabricate any integrated circuits or integrated circuits based on the information in this document.

Freescale Semiconductor reserves the right to make changes without further notice to any products herein. Freescale Semiconductor makes no warranty, representation or guarantee regarding the suitability of its products for any particular purpose, nor does Freescale Semiconductor assume any liability arising out of the application or use of any product or circuit, and specifically disclaims any and all liability, including without limitation consequential or incidental damages. "Typical" parameters that may be provided in Freescale Semiconductor data sheets and/or specifications can and do vary in different applications and actual performance may vary over time. All operating parameters, including "Typicals", must be validated for each customer application by customer's technical experts. Freescale Semiconductor does not convey any license under its patent rights nor the rights of others. Freescale Semiconductor products are not designed, intended, or authorized for use as components in systems intended for surgical implant into the body, or other applications intended to support or sustain life, or for any other application in which the failure of the Freescale Semiconductor product could create a situation where personal injury or death may occur. Should Buyer purchase or use Freescale Semiconductor products for any such unintended or unauthorized application, Buyer shall indemnify and hold Freescale Semiconductor and its officers, employees, subsidiaries, affiliates, and distributors harmless against all claims, costs, damages, and expenses, and reasonable attorney fees arising out of, directly or indirectly, any claim of personal injury or death associated with such unintended or unauthorized use, even if such claim alleges that Freescale Semiconductor was negligent regarding the design or manufacture of the part.

Freescale™ and the Freescale logo are trademarks of Freescale Semiconductor, Inc. All other product or service names are the property of their respective owners.

© Freescale Semiconductor, Inc. 2005-2008. All rights reserved.

