

HFE19-90

MINIATURE HIGH POWER LATCHING RELAY



认证号: 40037408



认证号.: CQC12002086394



Features

- 90A Latching relay
- Carrying 2400A peak current/10ms and contact won't welded (Type:445)
- Carrying the 6000A short circuit current/10ms without explosion
- 4kV dielectric strength (between coil and contact)
- Environmental friendly product (RoHS compliant)
- Outline Dimensions: (38.0 x 30.0 x 16.5) mm

CONTACT DATA

Contact arrangement	1A, 1B
Contact resistance	Typ.: 0.45mΩ max.(at 80A) ⁽¹⁾
Contact material	AgSnO ₂
Contact rating (Res. load)	90A 250VAC
Max. switching voltage	250VAC
Max. switching current	90A
Max. switching power	22500VA
Mechanical endurance	1 x 10 ⁵ OPS

Notes: (1) Typical value: Sampling quantity for contact resistance shall not less than 20 pcs, take the average value from 5 continuous measurements for each sample.

CHARACTERISTICS

Insulation resistance	1000MΩ (at 500VDC)	
Dielectric strength	Between coil & contacts	4000VAC 1min
	Between open contacts	1500VAC 1min
Creepage distance	8mm	
Operate time (at nomi. volt.)	20ms max.	
Release time (at nomi. volt.)	20ms max.	
Shock resistance	Functional	98m/s ²
	Destructive	980m/s ²
Vibration resistance	10Hz to 55Hz 1.5mm DA	
Humidity	5% to 85% RH	
Ambient temperature	-40°C to 70°C	
Termination	QC	
Unit weight	Approx. 50g	
Construction	Dust protected	

Notes: The data shown above are initial values.

COIL

Coil power	Single coil latching: Approx. 1.5W
	Double coils latching: Approx. 3.0W

COIL DATA

at 23°C

Single coil latching

Nominal Voltage VDC	Set / Reset Voltage VDC max.	Pulse Duration ms min.	Coil Resistance x (1±10%) Ω
5	3.5	100	16
6	4.2	100	24
9	6.3	100	54
12	8.4	100	96
24	16.8	100	384
48	33.6	100	1536

Double coils latching

Nominal Voltage VDC	Set / Reset Voltage VDC max.	Pulse Duration ms min.	Coil Resistance x (1±10%) Ω
5	3.5	100	8+8
6	4.2	100	12+12
9	6.3	100	27+27
12	8.4	100	48+48
24	16.8	100	192+192
48	33.6	100	768+768

ELECTRICAL ENDURANCE

UC Class	Voltage (Uc)	Current (Ic)	Power Factor	Close Open time (s)	Electrical endurance (OPS)
415 (UC1)	220VAC	60A	COSØ=1	10:20	3000
		10A	COSØ=0.4		3000
Nil		90A	COSØ=1		Total:6000

Remark:Electrical endurance meet IEC62055-31 test requirement, do the inductive load test after the resistive load test.
Only some typical ratings of UC are listed above, if more special ratings required, please contact us.



HONGFA RELAY

ISO9001, ISO/TS16949, ISO14001, OHSAS18001, IECQ QC 080000 CERTIFIED

2013 Rev. 1.00

ORDERING INFORMATION

Type	HFE19 -90/ 12 -D T -2 1 -R (445)							
Contact rating	90: 90A							
Coil voltage	5, 6, 9, 12, 24, 48VDC							
Contact form ¹⁾	D: 1 Form B H: 1 Form A							
Contact material	T: AgSnO ₂							
Coil angle form	2: Distance 5mm; No bowleg 4: Distance 5mm; L-bowleg							
Sort	1: Single coil latching 2: Double coils latching							
Polarity	R: Negative polarity Nil: Positive polarity							
Customer special code ²⁾	(415):UC1 (See electrical endurance) (459): Coil pins with reverse education way (445): Carrying 2400A peak current(10ms) and contact won't welded							

Notes: 1) H means that relay is on the "reset" status when delivery; D means that relay is on the "set" status when delivery. If no special required by customer, we will keep the relay on the "set" status when delivery.

2) UC1: Meet the UC1 requirements on IEC62055-31; Relays are able to pass the 30Imax short circuit.

3) We can make special design according to customer's requirement, Please see the typical design.

OUTLINE DIMENSIONS, WIRING DIAGRAM AND PC BOARD LAYOUT

Unit: mm

Outline Dimensions

L-bowleg

No bowleg

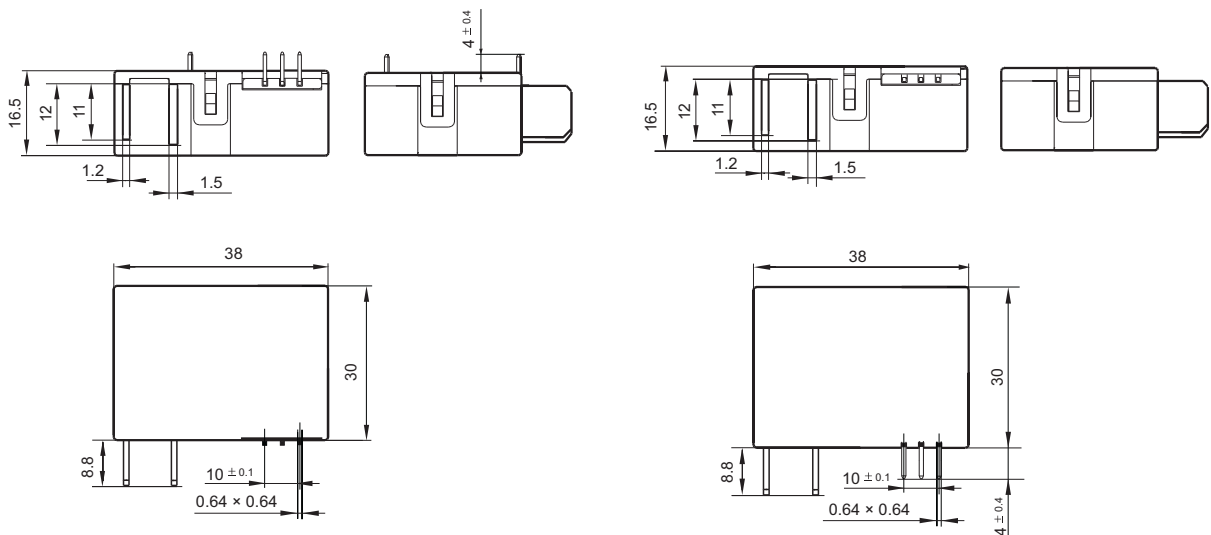

Remark: 1) In case of no tolerance shown in outline dimension: outline dimension ≤ 1 mm, tolerance should be ± 0.2 mm; outline dimension > 1 mm and ≤ 5 mm, tolerance should be ± 0.3 mm; outline dimension > 5 mm, tolerance should be ± 0.4 mm.

2) The tolerance without indicating for PCB layout is always ± 0.1 mm.

OUTLINE DIMENSIONS, WIRING DIAGRAM AND PC BOARD LAYOUT

Unit: mm

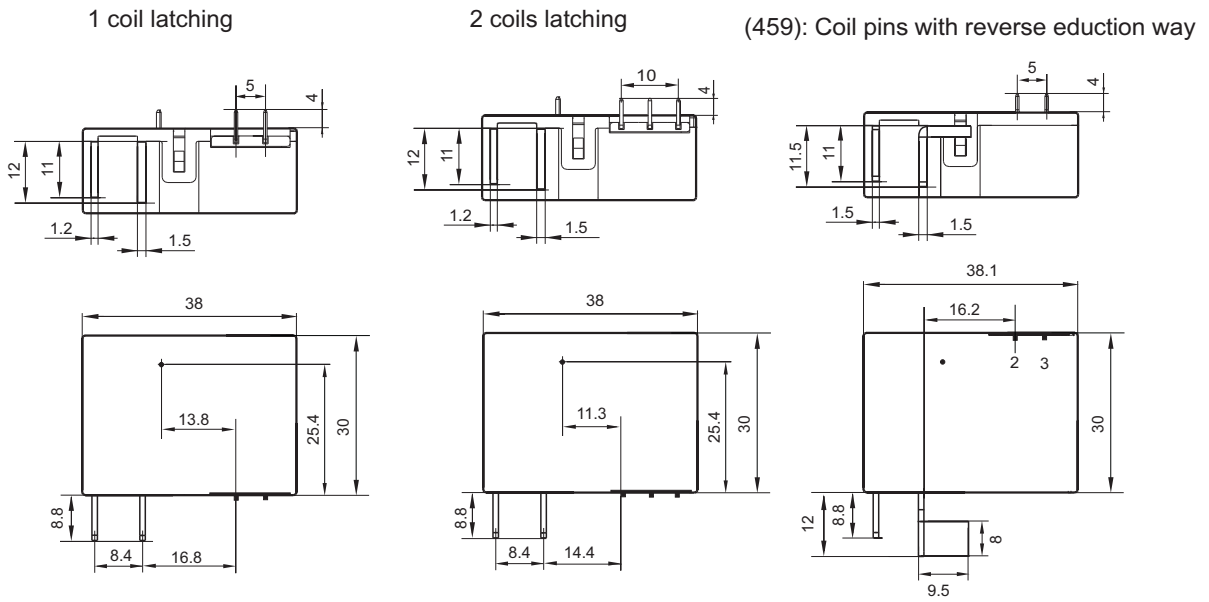

PCB Layout (Bottom view)

Single coil latching

Double coils latching

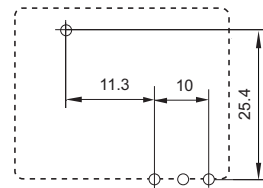
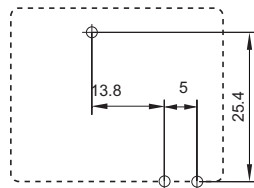

Wiring Diagram (Bottom view)

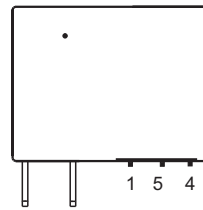
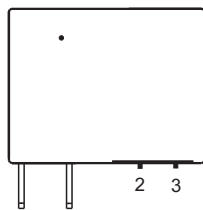

Positive polarity

Negative polarity

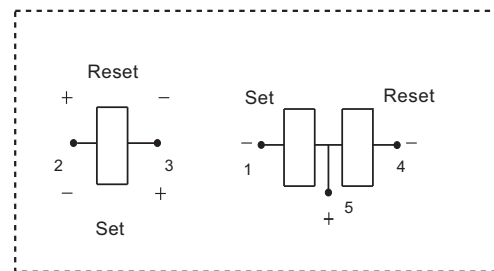
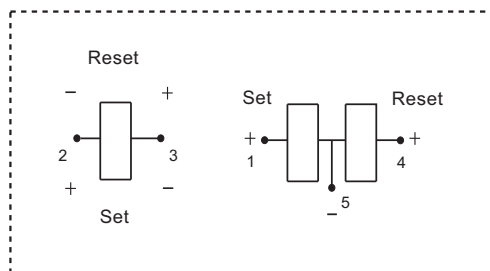

Typical Design

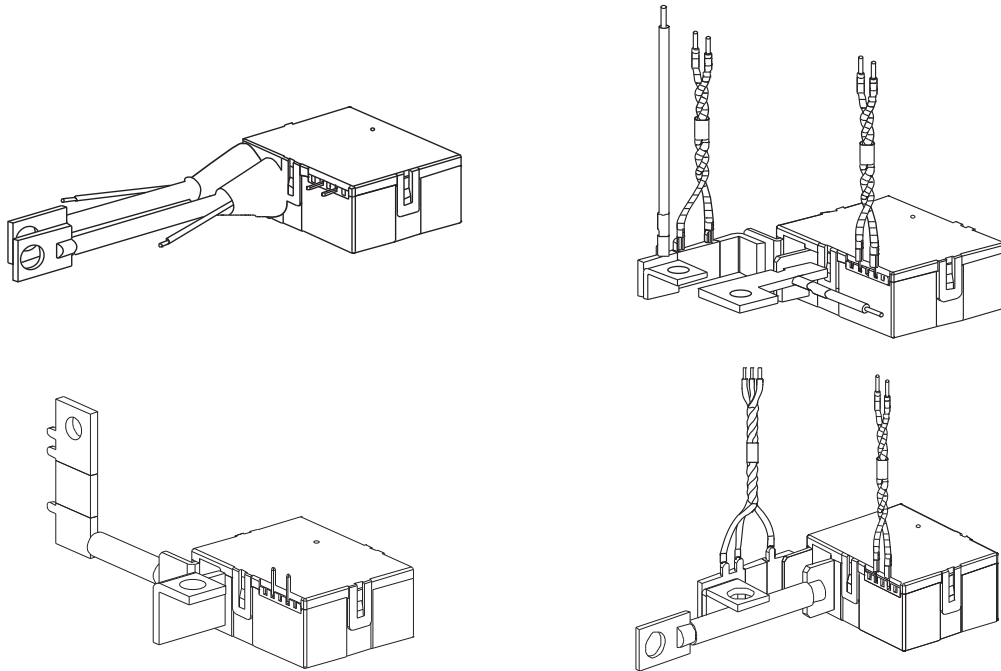

Notes: The drawing shown above are typical design,we can make special design according to customer's requirement. Please provide us with the drawing.

Notice

1. Relay is on the "reset" or "set" status when being released from stock, with the consideration of shock risen from transit and relay mounting, relay would be changed to "set" or "reset" status, therefore, when application (connecting the power supply), please reset the relay to "set" or "reset" status on request.
2. In order to maintain "set" or "reset" status, energized voltage to coil should reach the rated voltage, impulse width should be 5 times more than "set" or "reset" time. Do not energize voltage to "set" coil and "reset" coil simultaneously. And also long energized time (more than 1 min) should be avoided.
3. The terminals of relay without twisted copper wire can not be tin-soldered, can not be moved willfully.
4. Relays used for metering measuring applications are usually made with dust proof structure, while most relays could be made specially per customer's specific requirements.No longer than 6 months' storage time is recommended for this kind of relay, and please pay attention to the storage environment. To ensure contact reliability, we will keep contact status be closed when delivery if no special required by customer.

Disclaimer

This datasheet is for the customers' reference. All the specifications are subject to change without notice.

We could not evaluate all the performance and all the parameters for every possible application. Thus the user should be in a right position to choose the suitable product for their own application. If there is any query, please contact Hongfa for the technical service. However, it is the user's responsibility to determine which product should be used only.