

Renesas Flash Programmer V2.04

Flash memory programming software

User's Manual: RX100, RX200, RX600 (Except RX64x)

All information contained in these materials, including products and product specifications, represents information on the product at the time of publication and is subject to change by Renesas Electronics Corp. without notice. Please review the latest information published by Renesas Electronics Corp. through various means, including the Renesas Electronics Corp. website (<http://www.renesas.com>).

Notice

1. Descriptions of circuits, software and other related information in this document are provided only to illustrate the operation of semiconductor products and application examples. You are fully responsible for the incorporation of these circuits, software, and information in the design of your equipment. Renesas Electronics assumes no responsibility for any losses incurred by you or third parties arising from the use of these circuits, software, or information.
2. Renesas Electronics has used reasonable care in preparing the information included in this document, but Renesas Electronics does not warrant that such information is error free. Renesas Electronics assumes no liability whatsoever for any damages incurred by you resulting from errors in or omissions from the information included herein.
3. Renesas Electronics does not assume any liability for infringement of patents, copyrights, or other intellectual property rights of third parties by or arising from the use of Renesas Electronics products or technical information described in this document. No license, express, implied or otherwise, is granted hereby under any patents, copyrights or other intellectual property rights of Renesas Electronics or others.
4. You should not alter, modify, copy, or otherwise misappropriate any Renesas Electronics product, whether in whole or in part. Renesas Electronics assumes no responsibility for any losses incurred by you or third parties arising from such alteration, modification, copy or otherwise misappropriation of Renesas Electronics product.
5. Renesas Electronics products are classified according to the following two quality grades: "Standard" and "High Quality". The recommended applications for each Renesas Electronics product depends on the product's quality grade, as indicated below.
"Standard": Computers; office equipment; communications equipment; test and measurement equipment; audio and visual equipment; home electronic appliances; machine tools; personal electronic equipment; and industrial robots etc.
"High Quality": Transportation equipment (automobiles, trains, ships, etc.); traffic control systems; anti-disaster systems; anti-crime systems; and safety equipment etc.

Renesas Electronics products are neither intended nor authorized for use in products or systems that may pose a direct threat to human life or bodily injury (artificial life support devices or systems, surgical implantations etc.), or may cause serious property damages (nuclear reactor control systems, military equipment etc.). You must check the quality grade of each Renesas Electronics product before using it in a particular application. You may not use any Renesas Electronics product for any application for which it is not intended. Renesas Electronics shall not be in any way liable for any damages or losses incurred by you or third parties arising from the use of any Renesas Electronics product for which the product is not intended by Renesas Electronics.
6. You should use the Renesas Electronics products described in this document within the range specified by Renesas Electronics, especially with respect to the maximum rating, operating supply voltage range, movement power voltage range, heat radiation characteristics, installation and other product characteristics. Renesas Electronics shall have no liability for malfunctions or damages arising out of the use of Renesas Electronics products beyond such specified ranges.
7. Although Renesas Electronics endeavors to improve the quality and reliability of its products, semiconductor products have specific characteristics such as the occurrence of failure at a certain rate and malfunctions under certain use conditions. Further, Renesas Electronics products are not subject to radiation resistance design. Please be sure to implement safety measures to guard them against the possibility of physical injury, and injury or damage caused by fire in the event of the failure of a Renesas Electronics product, such as safety design for hardware and software including but not limited to redundancy, fire control and malfunction prevention, appropriate treatment for aging degradation or any other appropriate measures. Because the evaluation of microcomputer software alone is very difficult, please evaluate the safety of the final products or systems manufactured by you.
8. Please contact a Renesas Electronics sales office for details as to environmental matters such as the environmental compatibility of each Renesas Electronics product. Please use Renesas Electronics products in compliance with all applicable laws and regulations that regulate the inclusion or use of controlled substances, including without limitation, the EU RoHS Directive. Renesas Electronics assumes no liability for damages or losses occurring as a result of your noncompliance with applicable laws and regulations.
9. Renesas Electronics products and technology may not be used for or incorporated into any products or systems whose manufacture, use, or sale is prohibited under any applicable domestic or foreign laws or regulations. You should not use Renesas Electronics products or technology described in this document for any purpose relating to military applications or use by the military, including but not limited to the development of weapons of mass destruction. When exporting the Renesas Electronics products or technology described in this document, you should comply with the applicable export control laws and regulations and follow the procedures required by such laws and regulations.
10. It is the responsibility of the buyer or distributor of Renesas Electronics products, who distributes, disposes of, or otherwise places the product with a third party, to notify such third party in advance of the contents and conditions set forth in this document, Renesas Electronics assumes no responsibility for any losses incurred by you or third parties as a result of unauthorized use of Renesas Electronics products.
11. This document may not be reproduced or duplicated in any form, in whole or in part, without prior written consent of Renesas Electronics.
12. Please contact a Renesas Electronics sales office if you have any questions regarding the information contained in this document or Renesas Electronics products, or if you have any other inquiries.

(Note 1) "Renesas Electronics" as used in this document means Renesas Electronics Corporation and also includes its majority-owned subsidiaries.

(Note 2) "Renesas Electronics product(s)" means any product developed or manufactured by or for Renesas Electronics.

How to Use This Manual

Target Readers This manual is intended for users who are using the flash programmer in designing and developing a system that employs a Renesas Electronics microcontroller equipped with on-chip flash memory.

Purpose This manual is intended to give users an understanding of the basic specifications and correct use of the Renesas flash programmer.

Organization This manual includes the following sections.

- Basic operation (Basic mode)
- Function details (Basic mode)
- Function details (Full mode)
- Script execution function

How to Read This Manual It is assumed that the readers of this manual have general knowledge of electricity, logic circuits, and microcontrollers.

Conventions **Note:** Footnote for item marked with **Note** in the text.

Caution: Information requiring particular attention

Remark: Supplementary information

Numeral representation: Binary ... xxxx or xxxxB

Decimal ... xxxx

Hexadecimal ... 0XXXXX or xxxxH

“ ”: Any character or item on the screen that can be selected or input

: Name of button

[]: Name of commands, dialog boxes, options, or areas on the screen

Related documents When using this manual, also refer to the following documents.

The related documents indicated in this publication may include preliminary versions.

However, preliminary versions are not marked as such.

Documents related to development tools

Document name	Document number
Renesas Flash Programmer V2.04 Common	R20UT2906E
Renesas Flash Programmer V2.04 RL78, 78K, V850	R20UT2907E
Renesas Flash Programmer V2.04 RX100, RX200, RX600(Except RX64x)	This manual
Renesas Flash Programmer V2.04 RH850, RX64x	R20UT2909E
E1 Emulator R0E000010KCE00 E20 Emulator R0E000200KCT00	R20UT0398E

Caution The related documents listed above are subject to change without notice.

Be sure to use the latest version of each document for designing, etc.

Term replacement When the RX100 is used, some terms in this manual should be replaced as shown in the table below.

Term	To be replaced with
Flash shield window	Area protection
USB Direct	USB interface mode
Get Flash options	Access window read
Set Security	Access window program

CONTENTS

CHAPTER 1	BASIC OPERATION (BASIC MODE) - RX	7
CHAPTER 2	FUNCTION DETAILS (BASIC MODE) - RX	18
2.1	Introduction	18
2.2	Starting up	18
2.2.1	[Welcome!] dialog box	19
2.2.2	[Create a new workspace] dialog box	20
2.2.3	[Communication Interface] dialog box	21
2.2.4	[Power Supply] dialog box	22
2.2.5	[Mode Pin at Connection] dialog box	23
2.2.6	[Connection and Query] dialog box	24
2.2.7	[Frequency] dialog box	26
2.2.8	[Communication Speed] dialog box	28
2.2.9	[Project Settings] dialog box	29
2.2.10	Open latest workspace	30
2.2.11	Open workspace	30
2.3	Main Window	32
2.4	Menu Bar	33
2.4.1	[File] menu	33
2.4.2	[Tool] menu	35
2.4.3	[Microcontroller] menu	36
2.4.4	[Help] menu	52
2.5	[Microcontroller] Area	52
2.6	[Program File] Area	53
2.7	[Command] Area	53
2.8	Start Button	54
2.9	Status Bar	54
2.10	Output Panel	55
2.11	Clear Output Panel Button	55
CHAPTER 3	FUNCTION DETAILS (FULL MODE) - RX	56
3.1	Introduction	56
3.2	Starting up	56
3.3	Main Window	57
3.4	Menu Bar	58
3.4.1	[File] menu	58
3.4.2	[Tool] menu	58
3.4.3	[Microcontroller] menu	59
3.4.4	[Help] menu	60
3.5	Tool Bar	60
3.6	[Workspace Tree] Panel	61
3.7	[Project Settings] Panel	63
3.8	Output Panel	63
3.9	Status Bar	63
CHAPTER 4	SCRIPT EXECUTION FUNCTION	64

4.1	Overview.....	64
4.2	Start and exit.....	64
4.3	Script file	65
4.4	Script commands	65
4.5	Log file.....	68
4.6	How to Handle Dialog Boxes Opened while the Program is Running	68

CHAPTER 1 BASIC OPERATION (BASIC MODE) - RX -

This chapter describes the operation method by using the RX as the target microcontroller as an example to help you understand a series of basic operations with the basic mode of RFP. This chapter covers how to start the system, execute the [Program] command, and write the target microcontroller.

- Series of operations described in this chapter:

The operating conditions are as follows:

Target microcontroller:	R5F562TAA (RX62T)
Target system:	Renesas Starter Kit for RX62T
Tool used:	E1
Interface:	2 wire UART
Communication speed setting:	1,562,500 bps
Frequency:	12.50 MHz (main clock × 8 multiplication, peripheral clock × 4 multiplication)
Power supply:	E1 (5.0 V (USB VBUS))
Other settings:	Initial value

The steps described in this chapter are as follows:

- (1) Installation
- (2) System connection
- (3) Connection of target system
- (4) Creation of workspace
- (5) Selection of program file
- (6) Execution of [Program] command
- (7) System shutdown

(1) Installation

See **Common CHAPTER 2 INSTALLATION** and install in the host PC.

(2) System connection

Connect the USB connector of RFP to the USB port on the host PC using a USB cable.

(3) Connection of target system

Connect the target cable of the tool used to the target system.

Remark Connect the target system before supplying V_{DD} power from the target system.

(4) Creation of workspace

<1> On the taskbar, click the **Start** button, point to [All Programs], [Renesas Electronics Utilities], [Programming Tools], [Renesas Flash Programmer Vx.xx], and then click [Renesas Flash Programmer Vx.xx]. The [Welcome!] dialog box will open. Select [Create new workspace.], select [Basic mode], and then click the **Next** button to open the [Create new workspace] dialog box.

Figure 1-1. [Welcome!] Dialog Box

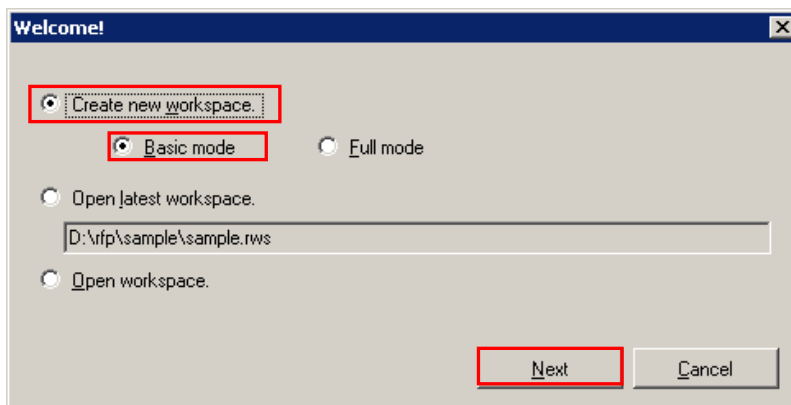

<2> In the [Using Target Microcontroller:] list box, select Group: “RX”, Device Name: “Generic Boot Device”. Enter any text string (such as “sample” in this case) in the [Workspace Name:] box, and specify any folder in the [Folder:] box. Clicking the **Next** button displays the [Communication Interface] dialog box.

Figure 1-2. [Create new workspace] Dialog Box

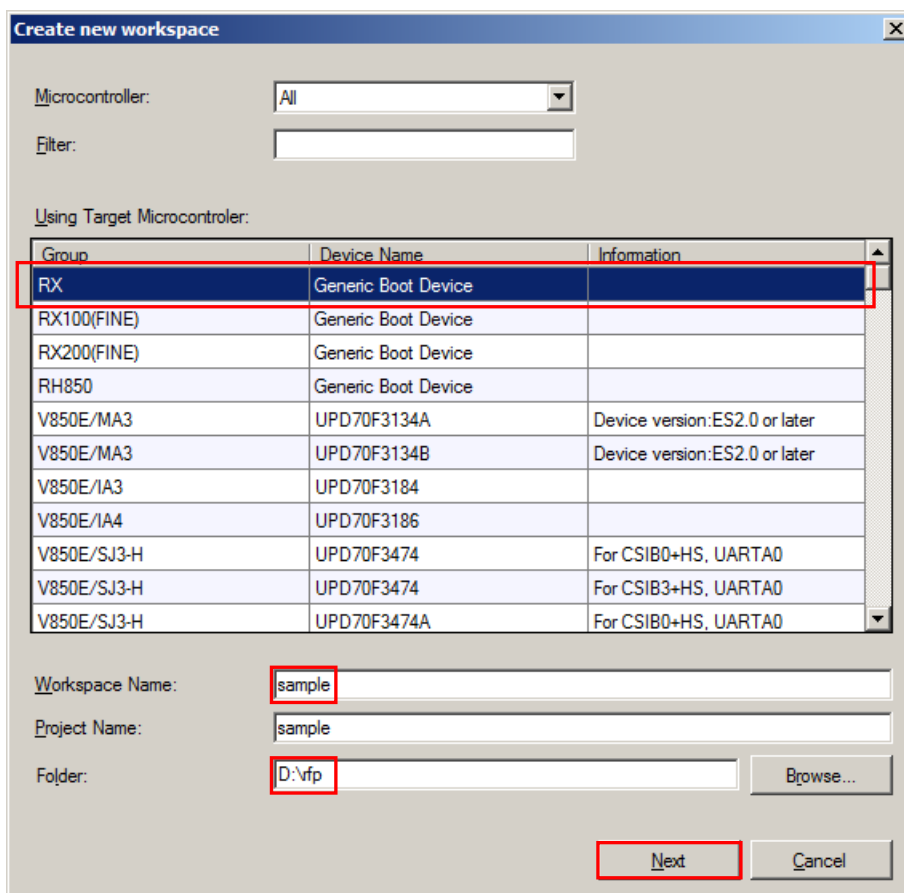

- <3> Select "E1" in the [Tool:] list box. For R5F562TAA, the selection in the [Interface] list box is fixed to "2 wire UART".
Clicking the [Next >] button displays the [Power Supply] dialog box.

Figure 1-3. [Communication Interface] Dialog Box

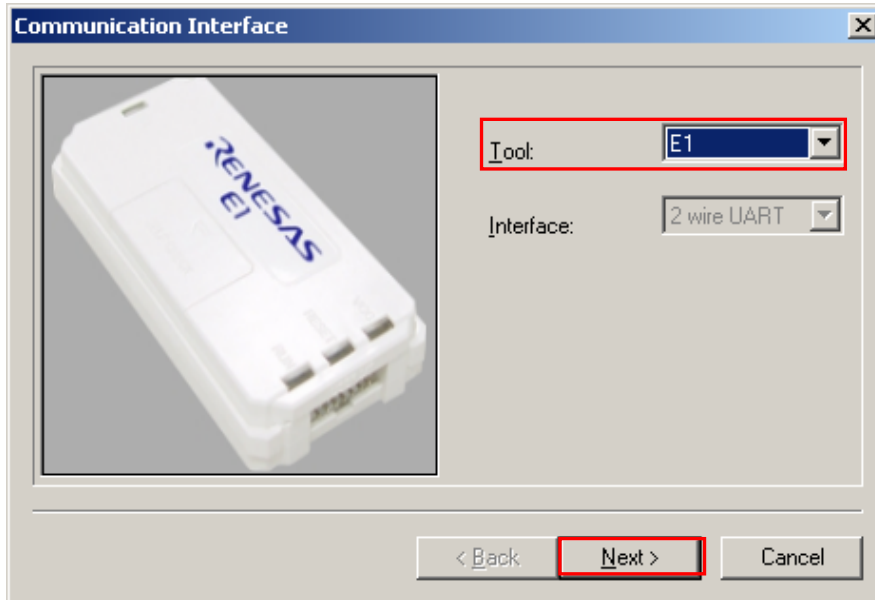

- <4> Select the [Power target from the emulator] check box, and then select "5.0 V (USB VBUS)" for [Supply voltage].
Clicking the [OK] button displays the [Mode Pin at Connection] dialog box.

Figure 1-4. [Power Supply] Dialog Box

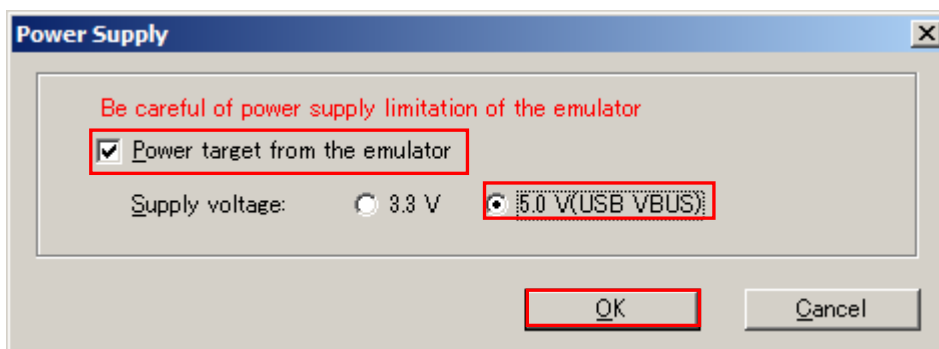

- <5> Set the [Pin Outputs] check boxes and [Pin Setting (High)] check boxes. For R5F562TAA, set io2 of E1 to High for the MD0 pin, and set io3 of E1 to Low for the MD1 pin. Clicking the **OK** button displays the [Confirmation] dialog box.

Figure 1-5. [Mode Pin at Connection] Dialog Box

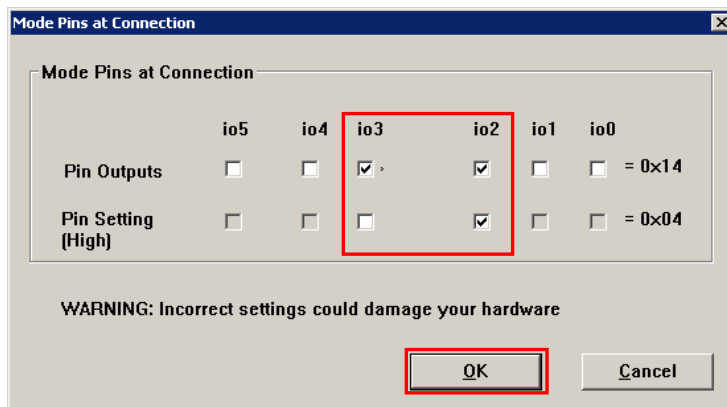

Remark: Processing the io pins is done to set the operating mode of the RX to the boot mode. For the RX62T, control must be applied to set the MD0 pin to the high level and the MD1 pin to the low level. This can be done by connecting any of pins from io0 to io5 of the E1/E20 and making the required settings in the [Mode Pins at Connection] dialog box. For the io0 to io5 pins of E1, refer to **Common APPENDIX B Figure B-1. E1 and E20 Pins - RX**.

- <6> Check that the board is connected, powered, and in Boot mode. Clicking the **OK** button displays the [Select Emulator] dialog box.

Figure 1-6. [Confirmation] Dialog Box

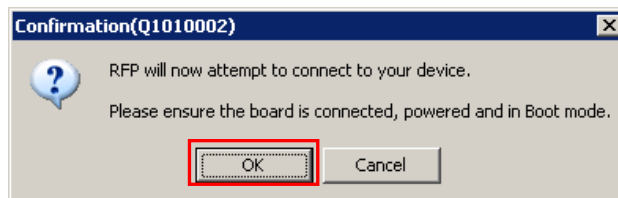

- <7> The name and serial number of the detected Emulator are displayed. Select it. The serial number is printed on the chassis. Clicking the **OK** button establish connection with the device and displays the [Query Generic Device] dialog box.

Figure 1-7. [Select Emulator] Dialog Box

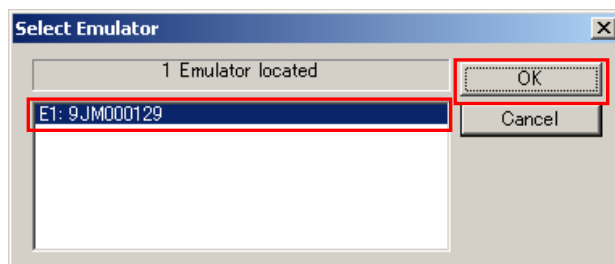

- <8> A query for the target microcontroller is performed.
Clicking the **OK** button displays the [Frequency] dialog box.

Figure 1-8. [Query Generic Device] Dialog Box

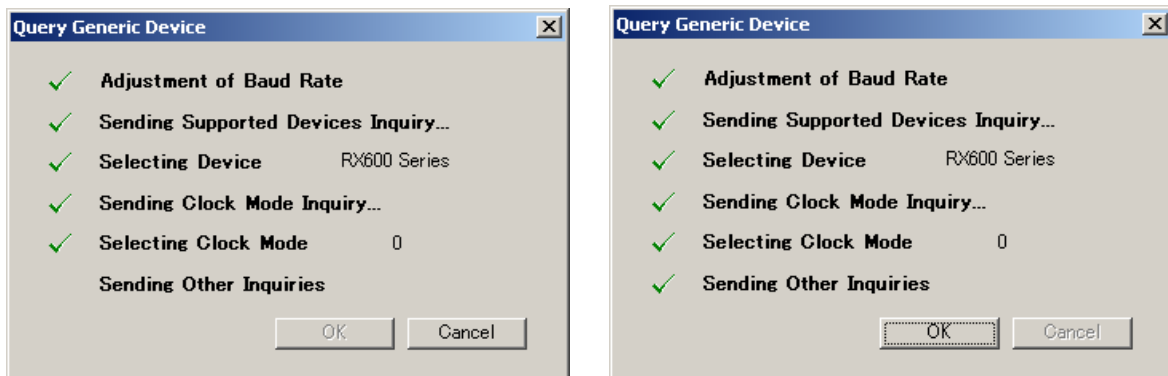

- <9> Enter “12.50” in the [Frequency:] box in the [Clock supply] area. The [Internal/External:] list box displays the result of the query “External Resonator or Clock”. Select “8” from the [CKM:] list box in the [Multiplier for the main clock or peripheral clock] area. Select “4” from the [CKP:] list box. The [Clock Mode:] list box displays the result of the query “0”.
Clicking the **Next >** button displays the [Communication Speed] dialog box.

Figure 1-9. [Frequency] Dialog Box

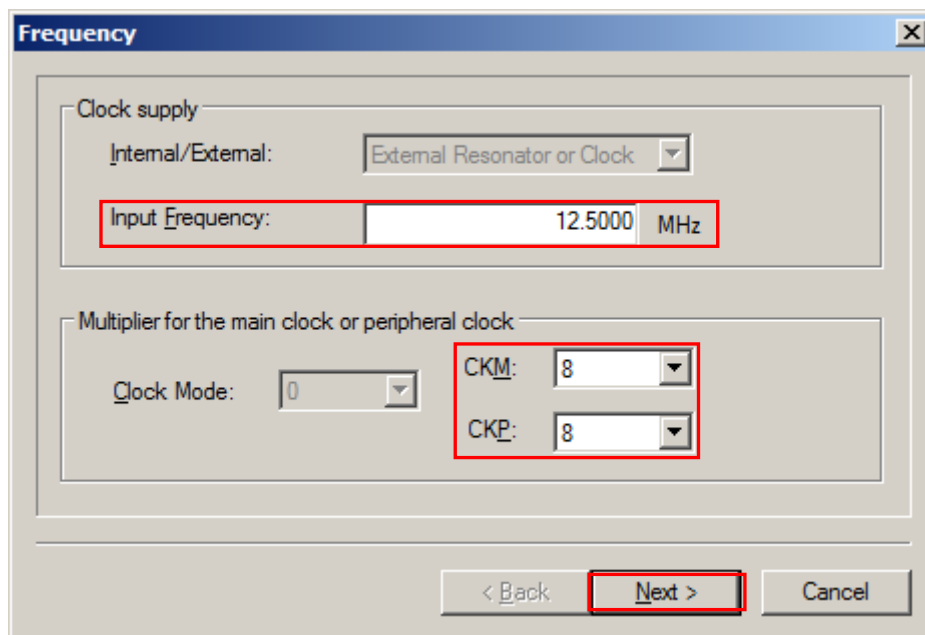

- <10> Clear the [Use Default] check box, and select “1562500” from the [Communication Speed (Recommended):] list box.
Clicking the [Finish] button displays the [Project Settings] dialog box.

Figure 1-10. [Communication Speed] Dialog Box

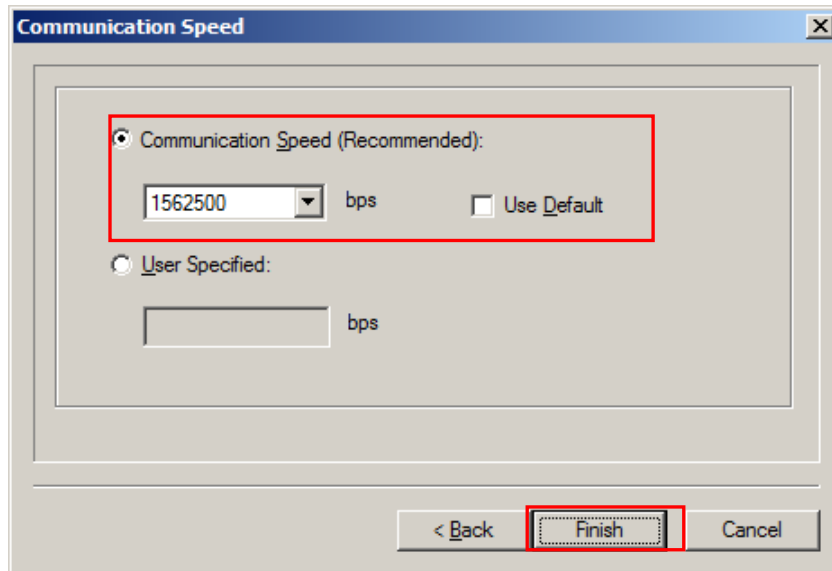

- <11> The [Basic Settings] tab in the [Project Settings] dialog box allows you to check basic information about programming. Clicking the [Other Settings] tab of the [Project Settings] dialog box displays the [Other Settings] tab in the [Project Settings] dialog box.

Figure 1-11. [Project Settings] Dialog Box [Basic Settings] Tab

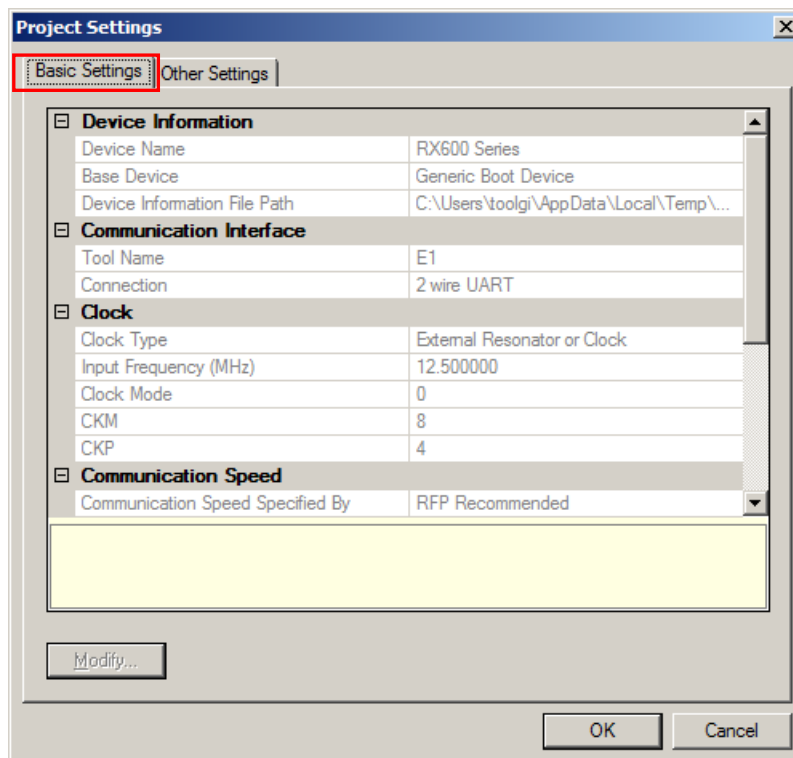

<12> The [Other Settings] tab in the [Project Settings] dialog box allows you to specify and check advanced information about programming. Leave the initial values for other settings. Clicking the **OK** button saves the project file and displays the main window.

Figure 1-12. [Project Settings] Dialog Box [Other Settings] Tab

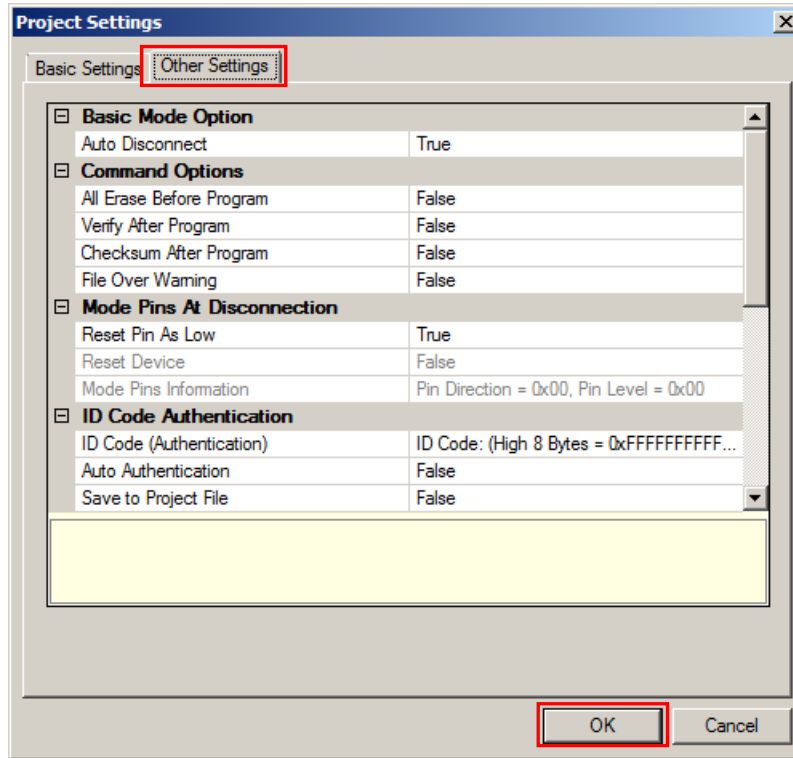

(5) Selection of program file

<1> Clicking the **Browse...** button in the User/Data area: of the program file area displays the [Open File] dialog box.

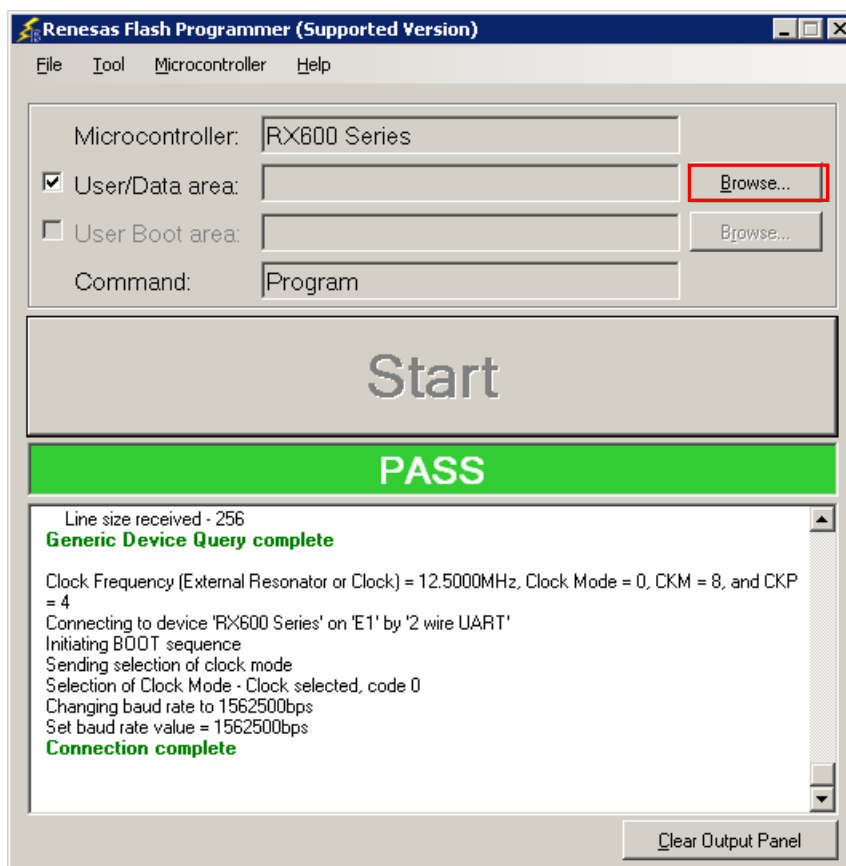
Figure 1-13. Main Window

<2> Select "sample.mot" in the [Open File] dialog box, and then click the **Open** button to open the main window.

Figure 1-14. [Open File] Dialog Box

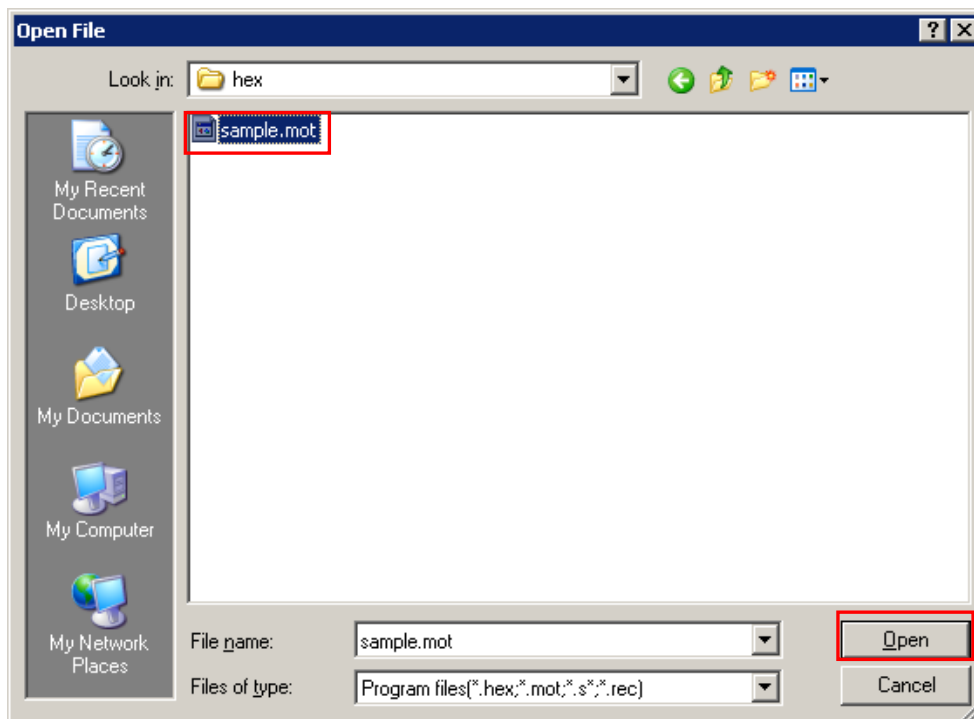

(6) Execute the [Program] command

- <1> Click the [Microcontroller] menu and select the [Program] command. A check mark is then placed on the left of the command, and the command is assigned to the [Start] button.

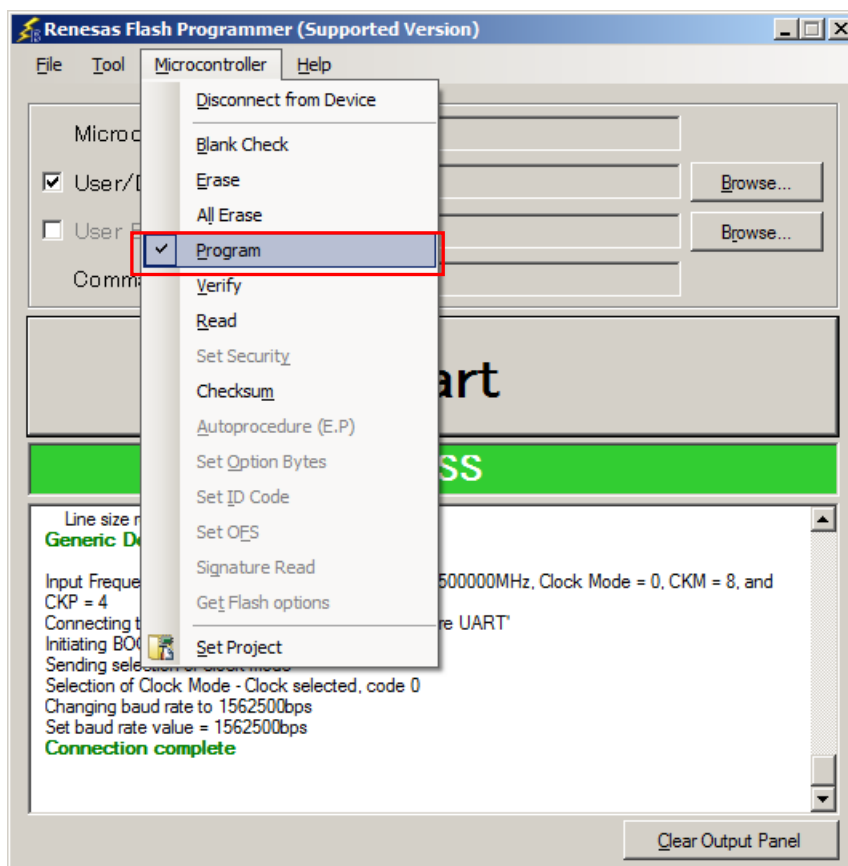
Figure 1-15. Main Window

- <2> After clicking the [Start] button, execute the [Program] command for R5F562TAA.

Remark When the [Program] command is executed, programming is performed after the block with data is erased. To erase all blocks, set [All Erase Before Program] in the [Command Options] category in the [Other Settings] tab of the [Project Settings] dialog box to "True."

- <3> When execution of the [Program] command ends normally, "Image written to device" and "Disconnected" are displayed on the output panel.

Remarks

1. When necessary, connect the tool to be used to the target system, and then execute the [Program] command.
2. When supplying V_{DD} power to the target system, first turn off the power, connect the target system (for programming), and then turn on the power and execute the [Program] command.

Figure 1-16. [Program] Command Execution Results

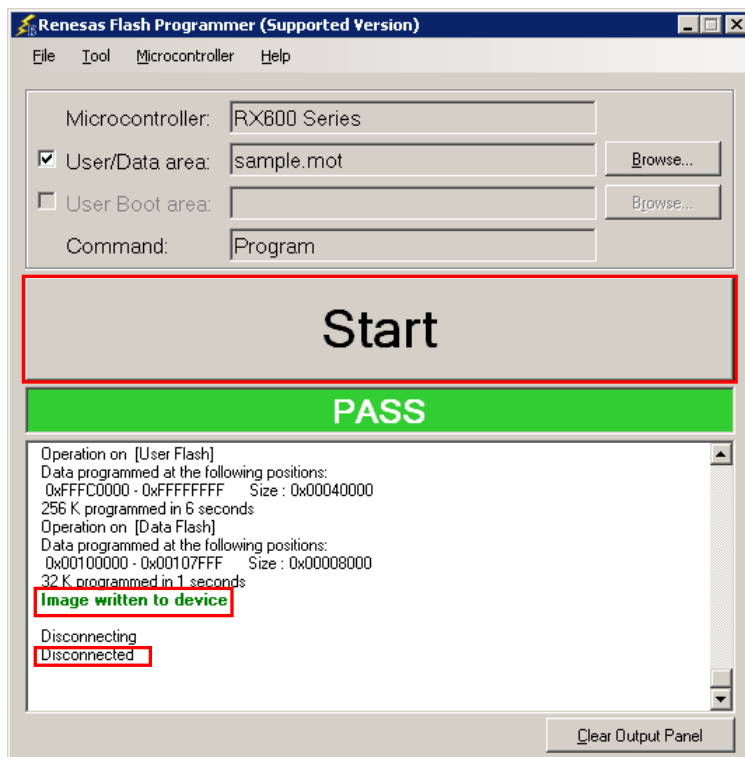

(7) System shutdown

- <1> Unless there are other target microcontrollers to be programmed, click the [File] menu and select the [Exit] command to close RFP. All settings made so far will be saved to a project file.
- <2> Remove the USB cable from the tool used.
- <3> Disconnect the target cable from the target system.

Remark When supplying V_{DD} power to the target system, turn off the power before removing the target cable. Furthermore, if [Auto Disconnect] in the [Basic Mode Options] category in the [Other Settings] tab of the [Project Settings] dialog box is set to "False," remove the target system after executing [Disconnect To Device].

Caution If an error occurs during the above procedure, see Common CHAPTER 4 TROUBLESHOOTING and APPENDIX A MESSAGES.

Also see the user's manual of the tool used and execute diagnostic tests.

If the above still does not resolve the problem, see the FAQ (at <http://www.renesas.com/support/>), or contact Renesas via the Renesas website:
<http://www.renesas.com/contact/>.

CHAPTER 2 FUNCTION DETAILS (BASIC MODE) - RX -

This chapter describes function details of the commands, windows, and dialog boxes of the basic mode of RFP.

2.1 Introduction

Make sure that the RFP package is installed. For how to install the RFP package, see **Common CHAPTER 2 RFP INSTALLATION**. Before starting RFP, make sure that the debugger and utility are not running.

2.2 Starting up

On the taskbar, click the [Start] button, point to [All Programs], [Renesas Electronics Utilities], [Programming Tools], [Renesas Flash Programmer Vx.xx], and then click [Renesas Flash Programmer Vx.xx]. The [Welcome!] dialog box will open.

Follow the instructions that appear in the wizard. When setup is finished, the main window is displayed. The [Power Supply], [Mode Pin at Connection], [Frequency], and [Communication Speed] dialog boxes are skipped depending on the selected connection method.

Figure 2-1. Dialog Boxes Displayed in the Startup Wizard

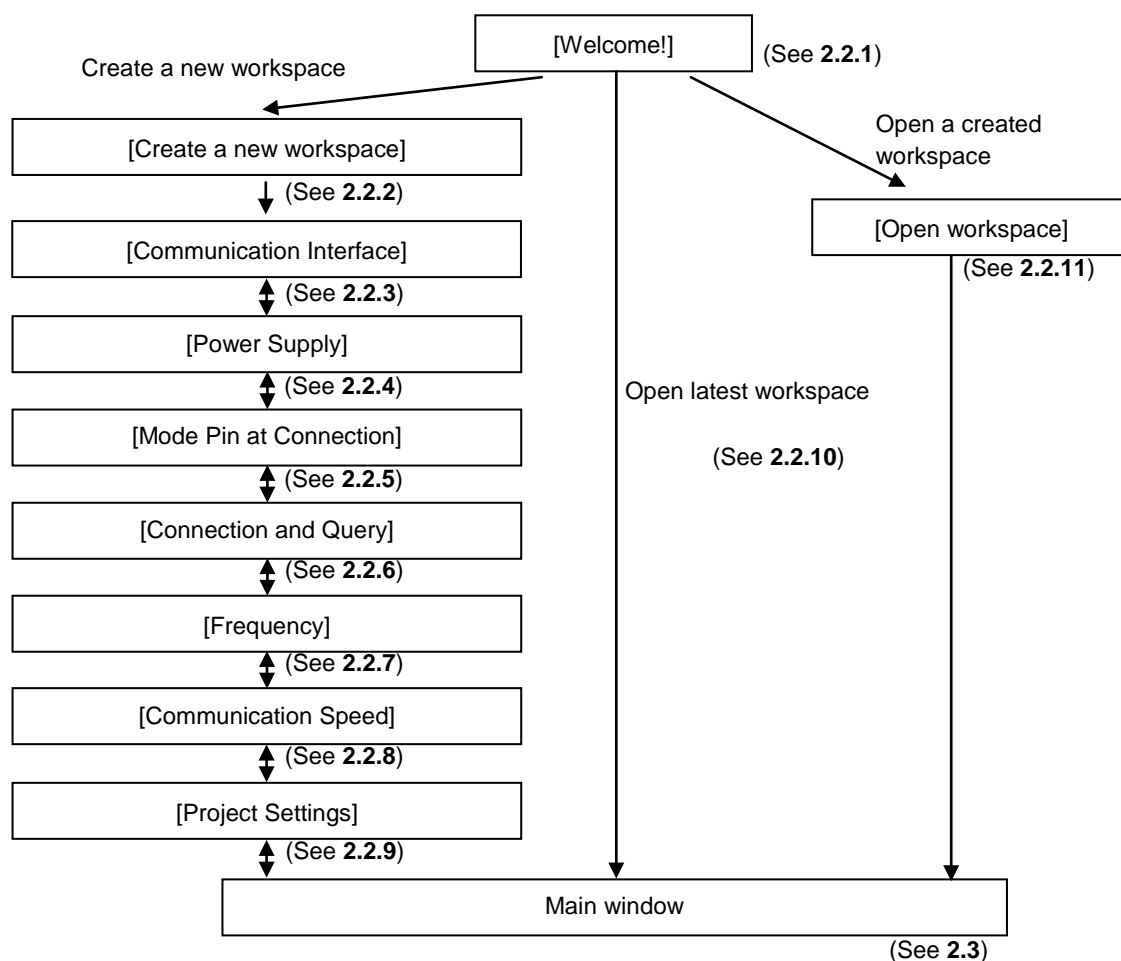

Or a main window is opened by the following method. In the case of (1), the main window of the version installed recently opens.

- (1) Double clicking a workspace file.
- (2) Dragging and dropping a workspace file onto RFP.exe.
- (3) Typing RFP.exe followed by the name of a workspace file at the command prompt and so on; then executing it.

2.2.1 [Welcome!] dialog box

This dialog box is used to make a selection about a workspace.

Figure 2-2. [Welcome!] Dialog Box

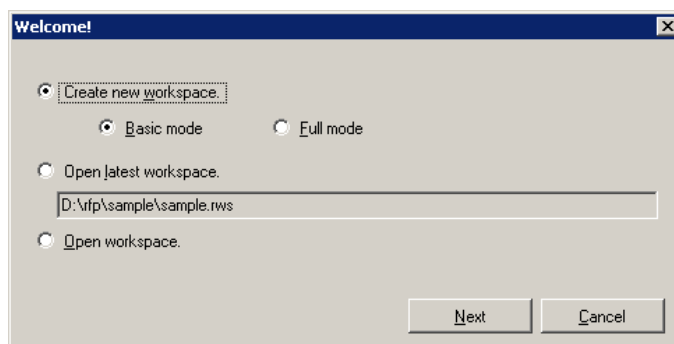

To create a new workspace, select [Create new workspace.], and then select [Basic mode] or [Full mode].

To open the workspace used last time, select [Open latest workspace.].

To open a created workspace, select [Open workspace.].

Clicking the [Next] button displays the next dialog box.

Clicking the [Cancel] or the [X] button terminates RFP.

2.2.2 [Create a new workspace] dialog box

This dialog box is used to create a new workspace.

Figure 2-3. [Create a new workspace] Dialog Box

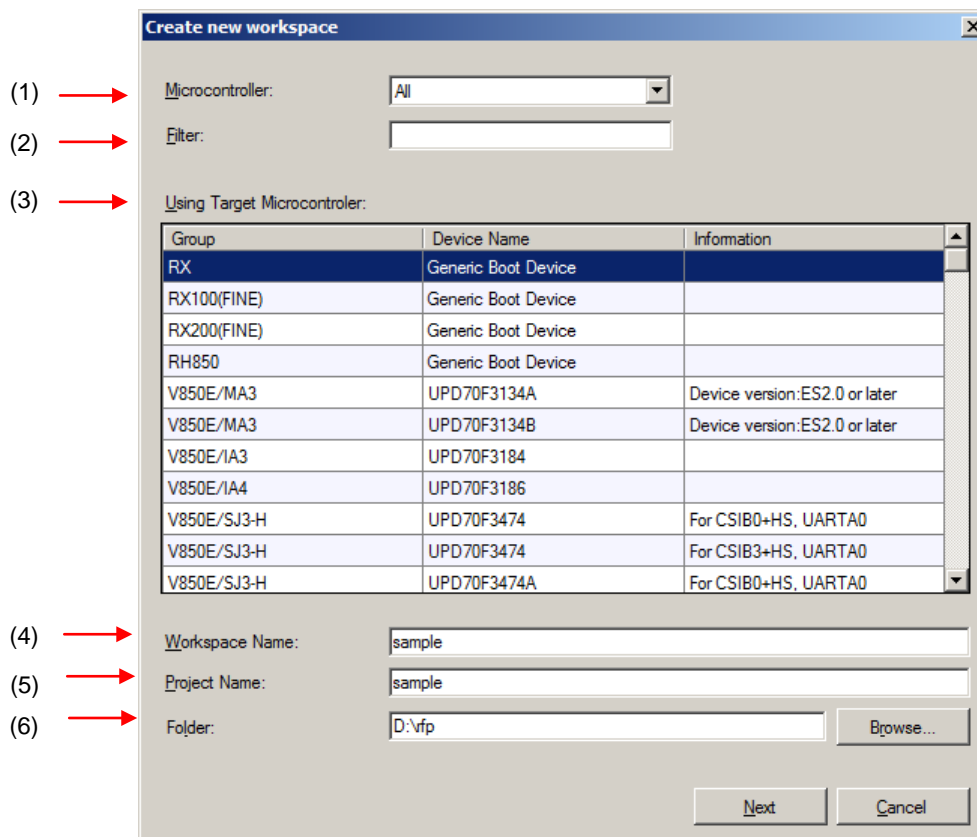

(1) [Microcontroller:] list box

Select "All", "Generic Boot Device", "V850", "RL78", or "78K" to narrow down the microcontrollers that can be selected in the [Using Target Microcontroller:] list box.

(2) [Filter:] box

Enter a character string that matches the character strings displayed in the [Using Target Microcontroller:] list box to narrow down the microcontrollers that can be selected in the [Using Target Microcontroller:] list box.

(3) [Using Target Microcontroller:] list box

Select the target microcontroller to be used.

(4) [Workspace Name:] box

Enter the workspace name in this box.

(5) [Project Name:] box

Enter the project name.

(6) [Folder:] box

Specify a folder in which to create the workspace file. Enter the path in the [Folder:] box, or click the [Browse...] button to display the [Select Folder] dialog box, and then specify the folder.

Clicking the [Next] button displays the next dialog box.

Clicking the [Cancel] or the [X] button terminates RFP.

2.2.3 [Communication Interface] dialog box

This dialog box is used to select the tool used and display the connection method between the selected tool and the target microcontroller.

Figure 2-4. [Communication Interface] Dialog Box



(1) Tool image panel

An image of the tool selected in the [Select Tool:] list box is displayed.

Figure 2-5. Tool Image Panel



(2) [Tool:] list box

Select the tool to be used.

- E1
- E20
- USB Direct
- COMx

(3) [Interface:] list box

The connection method between the selected tool and the target microcontroller is displayed.

- 2 wire UART (when RX is selected)
- FINE (when RX100 (FINE) and RX200 (FINE) are selected)
- USB (when USB Direct is selected)

Clicking the **Next >** button displays the next dialog box.

Clicking the **Cancel** or the **X** button terminates RFP.

2.2.4 [Power Supply] dialog box

This dialog box is used to specify the power supply used for writing to the target microcontroller.

Figure 2-6. [Power Supply] Dialog Box

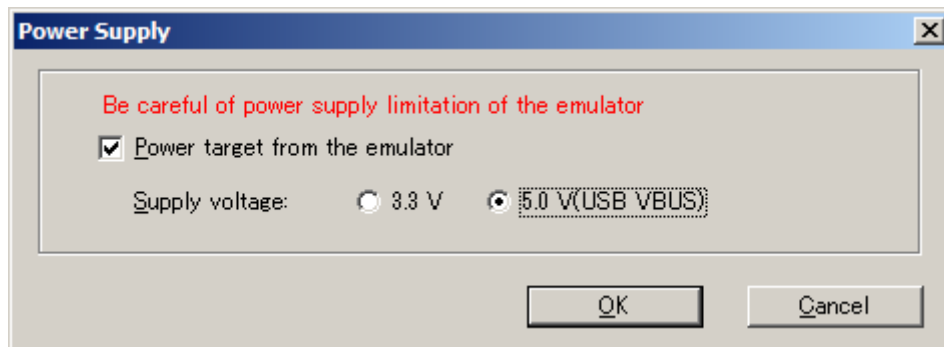

[Power target from the emulator] check box

Select this check box if supplying power from the emulator. Clear this check box if supplying power from the target system.

[Supply voltage:] option button

When supplying power from the tool used, select a voltage of 3.3 V or 5.0 V (USB VBUS).

Caution E1 supports the power supply function. In the mass-production process, do not use the power supply function of E1. Instead, supply the power suitable for the microcontroller specifications from the target system. The supply voltage from E1 is dependent on the USB power performance of the host PC, so the accuracy cannot be guaranteed.

Clicking the **OK** button displays the next dialog box.

Clicking the **Cancel** or the **X** button returns you to the [Communication Interface] dialog box.

2.2.5 [Mode Pin at Connection] dialog box

This dialog box is used to select the pin to control the mode pin of the target microcontroller from io0 to io5 pins of E1/E20.

Figure 2-7. [Mode Pin at Connection] Dialog Box

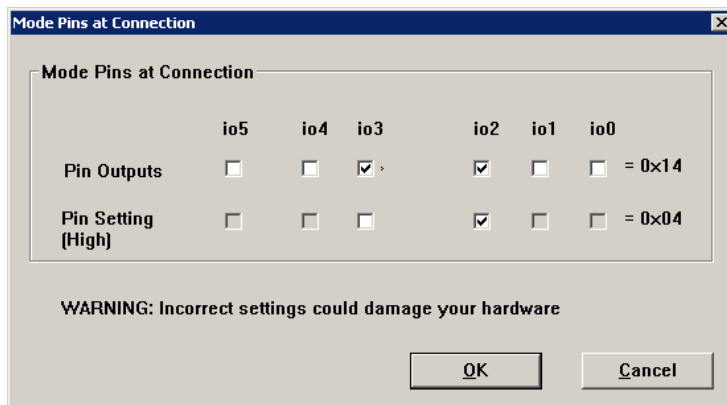

[Pin Outputs] check box

Select the pin to control the mode pin of the target microcontroller from io0 to io5 pins. A selected check box is output, and a cleared check box is input.

[Pin Setting (High)] check box

Set the level of the selected io0 to io5 pins to High or Low. A selected check box is High, and a cleared check box is Low. This setting is effective only when the I/O direction is Output.

Remark For the io0 to io5 pins of E1 and E20, refer to **Common APPENDIX B Figure B-1. E1 and E20 Pins - RX -**.

Clicking the **OK** button displays the next dialog box.

Clicking the **Cancel** or the **X** button returns you to the [Communication Interface] dialog box.

2.2.6 [Connection and Query] dialog box

This dialog box is used to perform connection and a query of the target microcontroller and create a device information file.

Caution The connection is maintained after querying the device until the disconnection processing is executed.

- (1) Confirm before connecting to the target microcontroller.

Figure 2-8. [Confirmation] Dialog Box

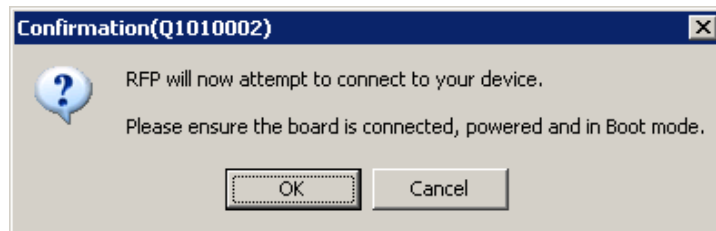

Clicking the **OK** button displays the next dialog box.

Clicking the **Cancel** or the **X** button returns you to the [Communication Interface] dialog box.

- (2) When E1 or E20 is selected, the [Select Emulator] dialog box is displayed. The name and serial number of the detected USB device are displayed. Select it.

Figure 2-9. [Select Emulator] Dialog Box

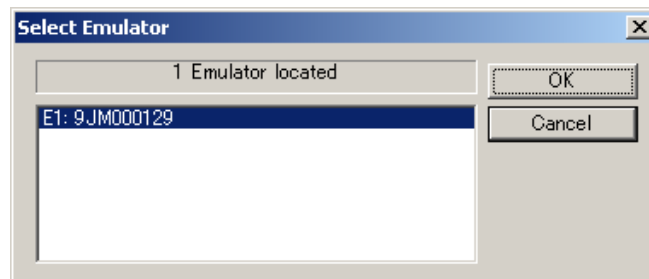

Clicking the **OK** button displays the next dialog box.

Clicking the **Cancel** or the **X** button returns you to the [Communication Interface] dialog box.

Remark This dialog box is displayed only when RFP starts up for the first time. It won't be displayed for the second time and on. After a restart of RFP, it is displayed only for the first time and not for the second time and on.

- (3) When USB Direct is selected, the [Select USB Device] dialog box is displayed. The detected USB port number is displayed. Select it.

Figure 2-10. [Select USB Device] Dialog Box

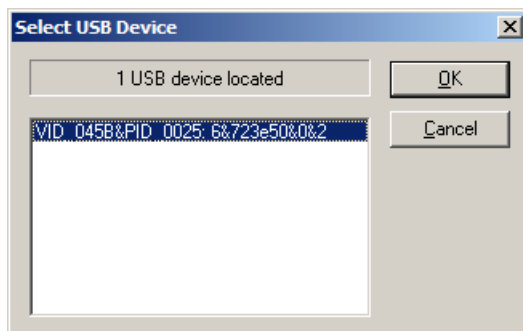

Clicking the **OK** button displays the next dialog box.
 Clicking the **Cancel** or the **X** button returns you to the [Communication Interface] dialog box.

Remark This dialog box is displayed only when RFP starts up for the first time. It won't be displayed for the second time and on. After a restart of RFP, it is displayed only for the first time and not for the second time and on.

- (4) A query for the target microcontroller is performed.

Figure 2-11. [Query Generic Device] Dialog Box

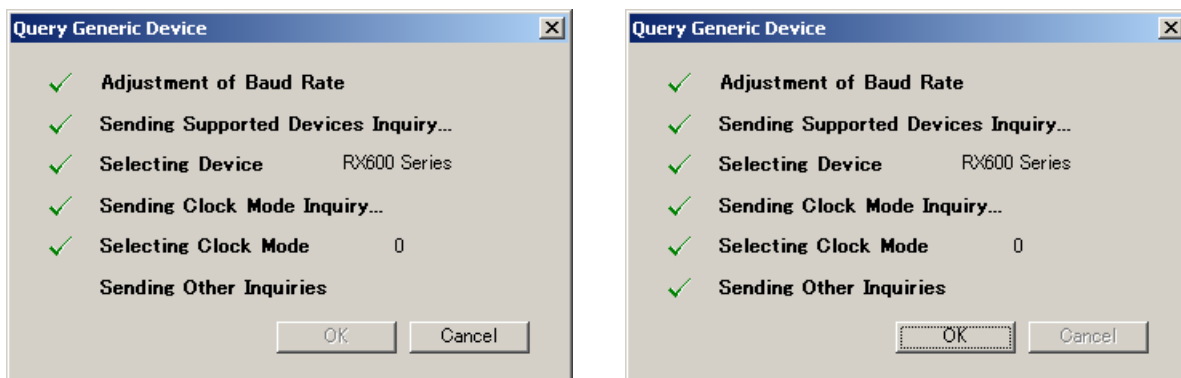

Clicking the **OK** button displays the next dialog box.
 Clicking the **Cancel** or the **X** button returns you to the [Communication Interface] dialog box.

- (5) For some microcontrollers, the [Select Device] dialog box opens at the time of query by [Select Device]. Select a device from the [Select a device:] box.

Figure 2-12 [Select Device] Dialog Box

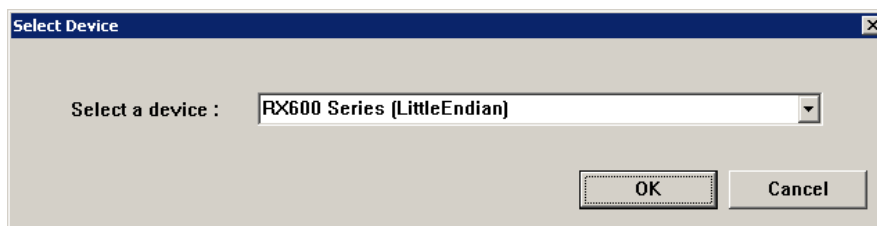

2.2.7 [Frequency] dialog box

This dialog box is used to set clock supply and multipliers for the main clock and peripheral clock.

Figure 2-13. [Frequency] Dialog Box

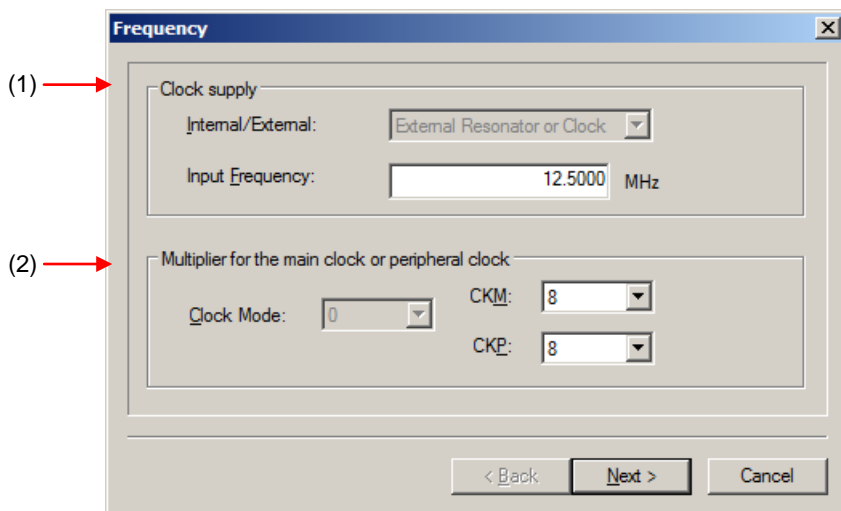

(1) [Clock supply] area

This area is used to select the communication speed at the port.

Figure 2-14. [Clock supply] Area

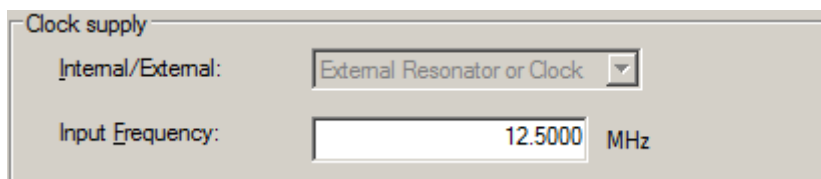

[Internal/External:] list box

Displays the type of clock supplied to the target microcontroller.

External Resonator or Clock	Clock or clock resonator for a microcontroller that does not support the clock switching function
External Clock	Clock for a microcontroller that supports the clock switching function
External Resonator	Clock resonator for a microcontroller that supports the clock switching function
Internal Clock	On-chip oscillator for a microcontroller that supports the clock switching function

[Input Frequency:] list box

Enter the clock supplied to the target microcontroller.

(2) [Multiplier for the main clock or peripheral clock] area

Set the clock mode, CKM, and CKP.

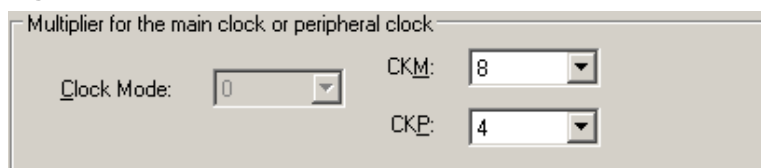
Figure 2-15. [Multiplier for the main clock or peripheral clock] Area

The screenshot shows a dialog box titled "Multiplier for the main clock or peripheral clock". It contains three dropdown menus arranged in two rows. The first row has "Clock Mode:" followed by a dropdown menu showing the value "0". The second row has "CKM:" followed by a dropdown menu showing the value "8", and "CKP:" followed by a dropdown menu showing the value "4".

[Clock Mode:] list box

Select a value.

[CKM:] list box

Select a multiplication ratio of the main clock.

[CKP:] list box

Select a multiplication ratio of the peripheral clock.

Remark For available multiplication ratios, refer to the user's manual of the target microcontroller.

Clicking the **< Back** button displays the previous dialog box.

Clicking the **Next >** button displays the next dialog box.

Clicking the **Cancel** or the **X** button terminates RFP.

2.2.8 [Communication Speed] dialog box

This dialog box is used to set communication speed.

Figure 2-16. [Communication Speed] Dialog Box

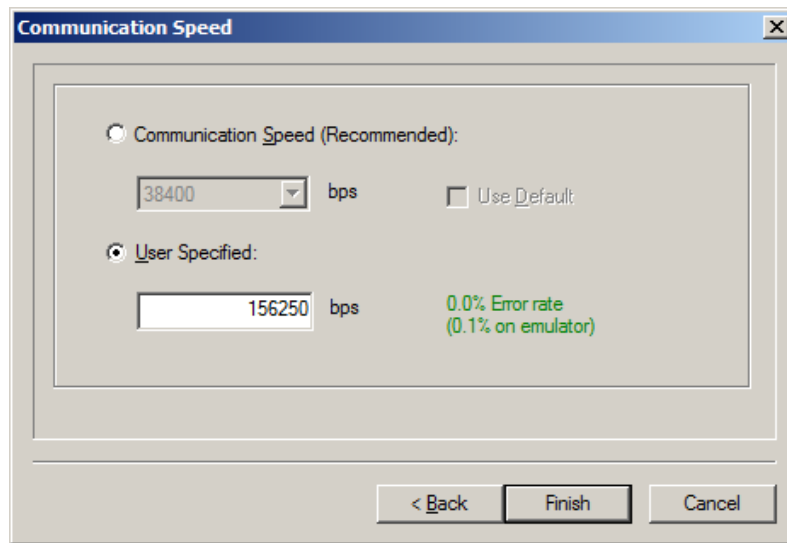

(1) [Communication Speed (Recommended):] list box

If the [Use Default] check box is selected, "38400" is selected. If the check box is cleared, one of the recommended baud rates can be selected.

(2) [User Specified:] box

When E1/E20 is selected, a non-standard communication speed can be entered. The displayed error takes into account the peripheral clock of the microcontroller, communication speed calculation formula, and the characteristics of E1/E20.

Clicking the **< Back** button displays the previous dialog box.

Clicking the **Finish** button displays the next dialog box.

Clicking the **Cancel** or the **X** button terminates RFP.

2.2.9 [Project Settings] dialog box

This dialog box is used to check and change the project settings. It has the [Basic Settings] tab and [Other Settings] tab. Selecting a tab changes the categories in which settings are displayed.

Figure 2-17. [Project Settings] Dialog Box

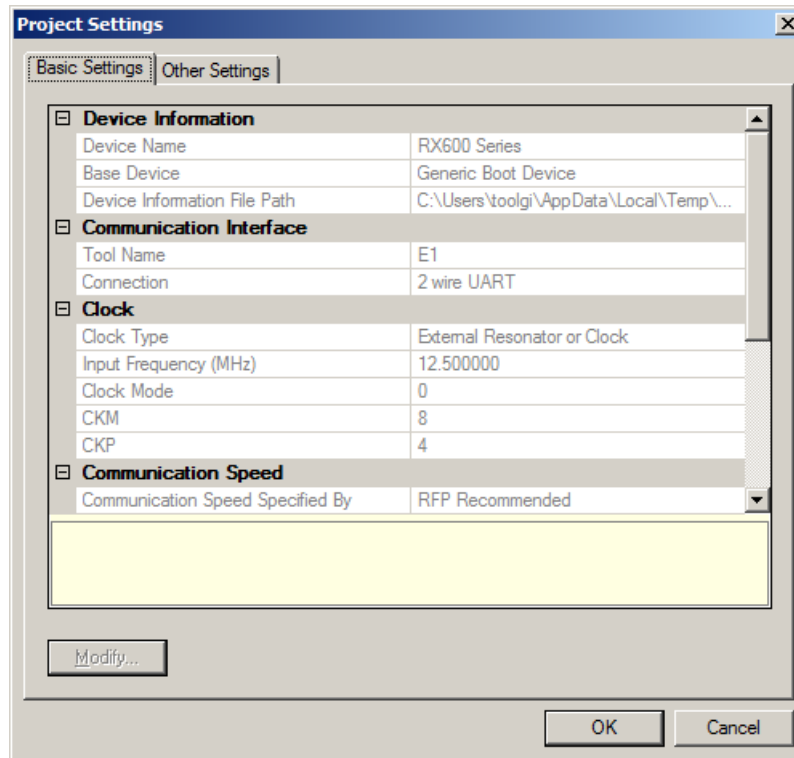

For details about each item, see 2.4.3 (11) (f) [Project Settings] dialog box.

Clicking the **Modify...** button opens the [Communication Interface] dialog box.

Clicking the **OK** button saves the project file and opens the main window.

Clicking the **Cancel** or the **X** button terminates RFP.

Remark The **Modify...** button is disabled while it is connected with the target controller. To enable it, select the **[Microcontroller]** menu and select **[Disconnect To Device]**, then select **[Project Settings]** from the **[Microcontroller]** menu to display the [Project Settings] dialog box.

2.2.10 Open latest workspace

If you select [Open latest workspace.] in the [Welcome!] dialog box, the main window is displayed with the settings for the workspace used last time.

Figure 2-18. [Open latest workspace.]

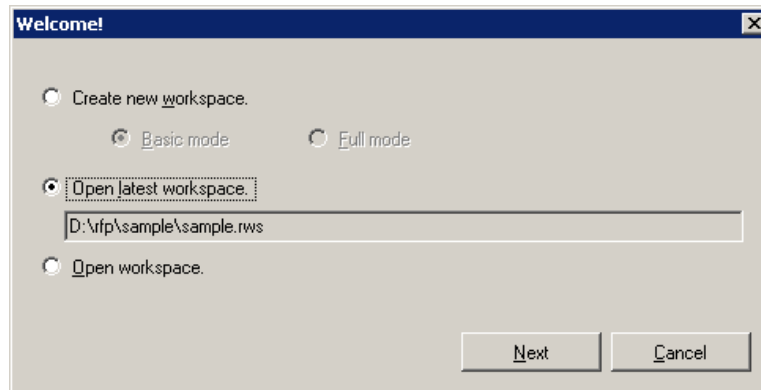

2.2.11 Open workspace

If you select [Open workspace.] in the [Welcome!] dialog box, the [Open File] dialog box is displayed.

Figure 2-19. [Open workspace.]

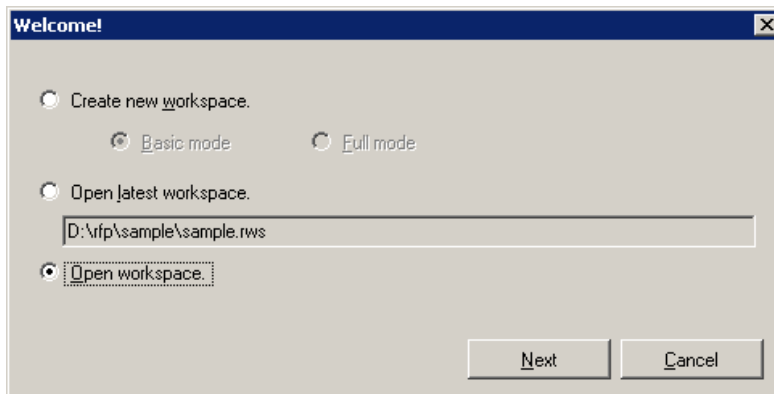
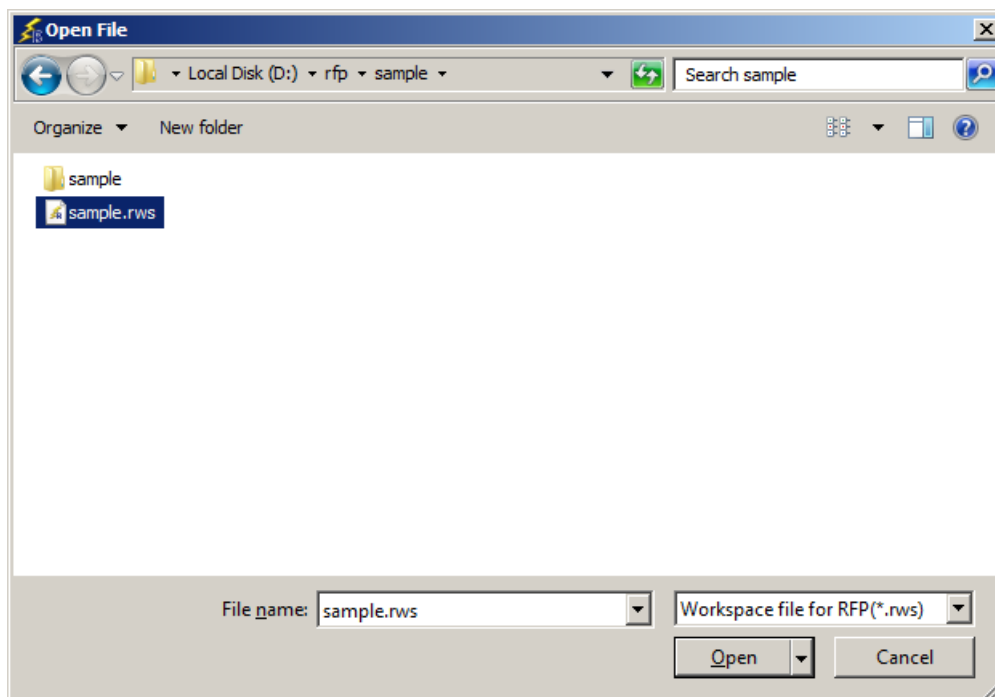

Figure 2-20. [Open File] Dialog Box



Select a workspace file, and then click the **Open** button. The main window is displayed with the settings for the specified workspace.

Clicking the **Cancel** or the **X** button closes the [Open File] dialog box and returns you to the [Welcome!] dialog box.

2.3 Main Window

The main window consists of the following items:

Figure 2-21. Main Window

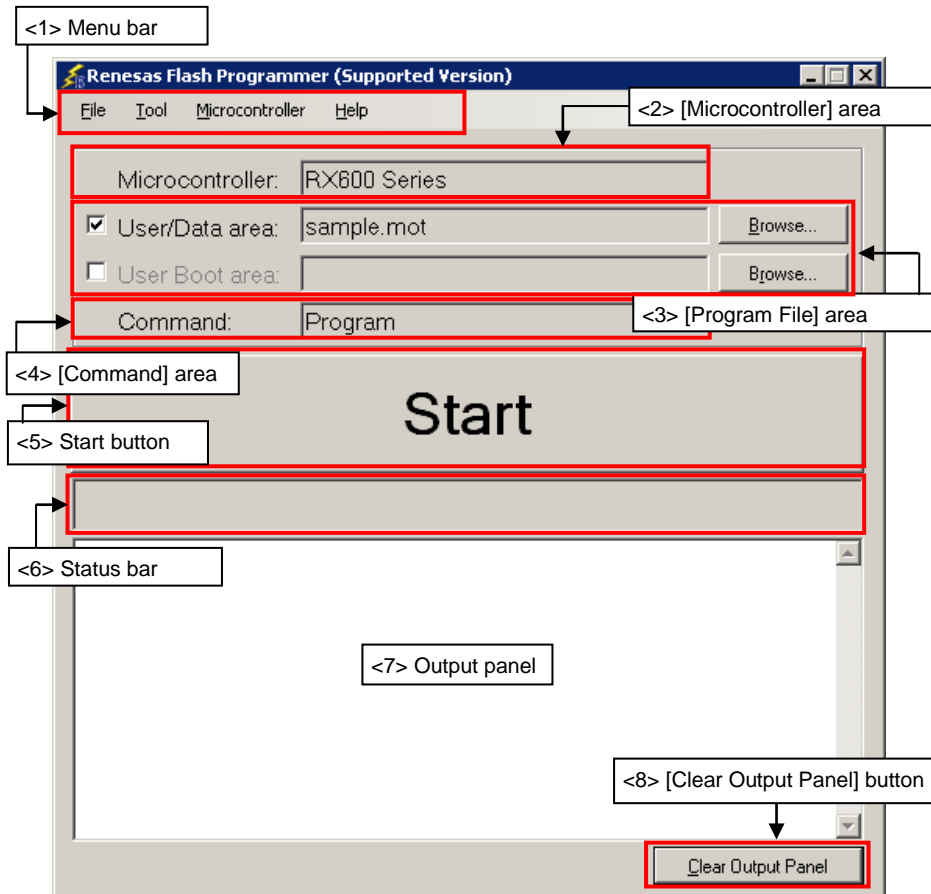

Name	Description	See
<1> Menu bar	Displays the selectable menus	2.4
<2> [Microcontroller] area	Displays the selected target microcontroller	2.5
<3> [Program File] area	Displays the selected program file	2.6
<4> [Command] area	Displays the selected command	2.7
<5> Start button	Executes the selected command	2.8
<6> Status bar	Displays the command execution status in colors and text	2.9
<7> Output panel	Displays in detail what is executed by the command	2.10
<8> [Clear Output Panel] button	Clears the output panel display	2.11

2.4 Menu Bar

The menu bar consists of [File], [Tool], [Microcontroller], and [Help]. When a menu is selected, the pull-down menu is displayed where the items can be selected. Some items may be disabled depending on the settings.

2.4.1 [File] menu

The following pull-down menu appears by selecting the [File] menu.

Figure 2-22. [File] Menu



(1) [Create a new workspace]

The [Create a new workspace] dialog box is displayed. Create a new workspace. Save the project file that has been created. For the items in the dialog box, refer to 2.2.2.

Figure 2-23. [Create new workspace] Dialog Box

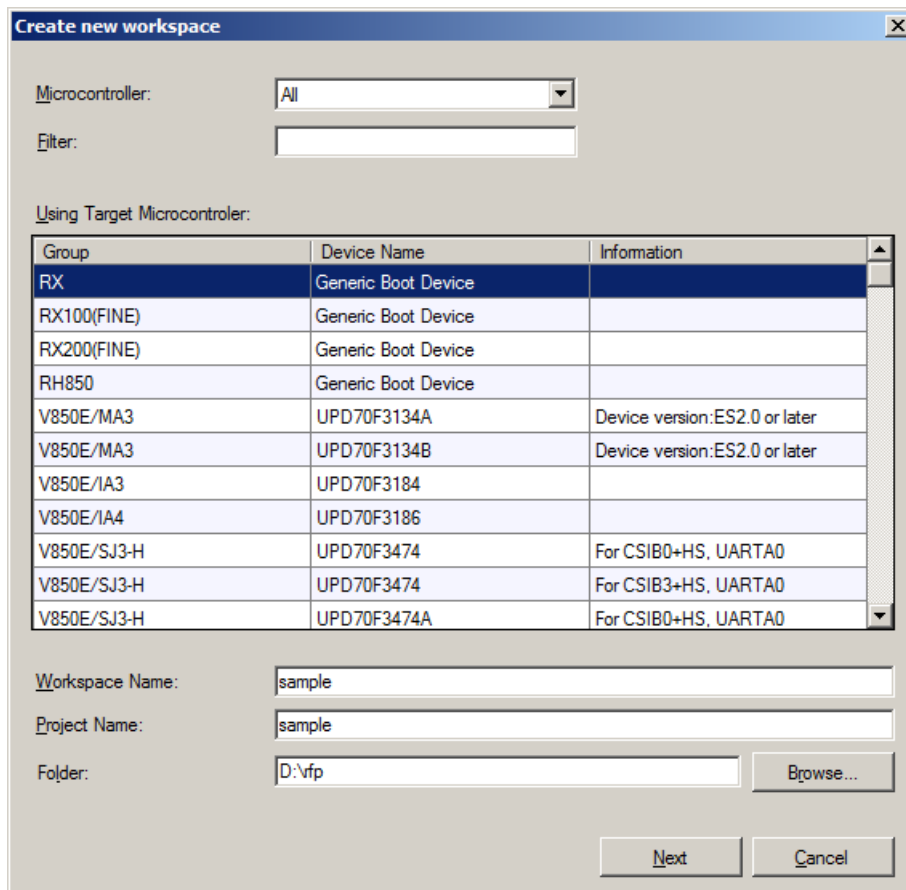

(2) [Open a workspace]

Selecting this option opens the [Open File] dialog box in which you can open a workspace created before. Save the project file that has been created. For the items in the dialog box, see 2.2.11.

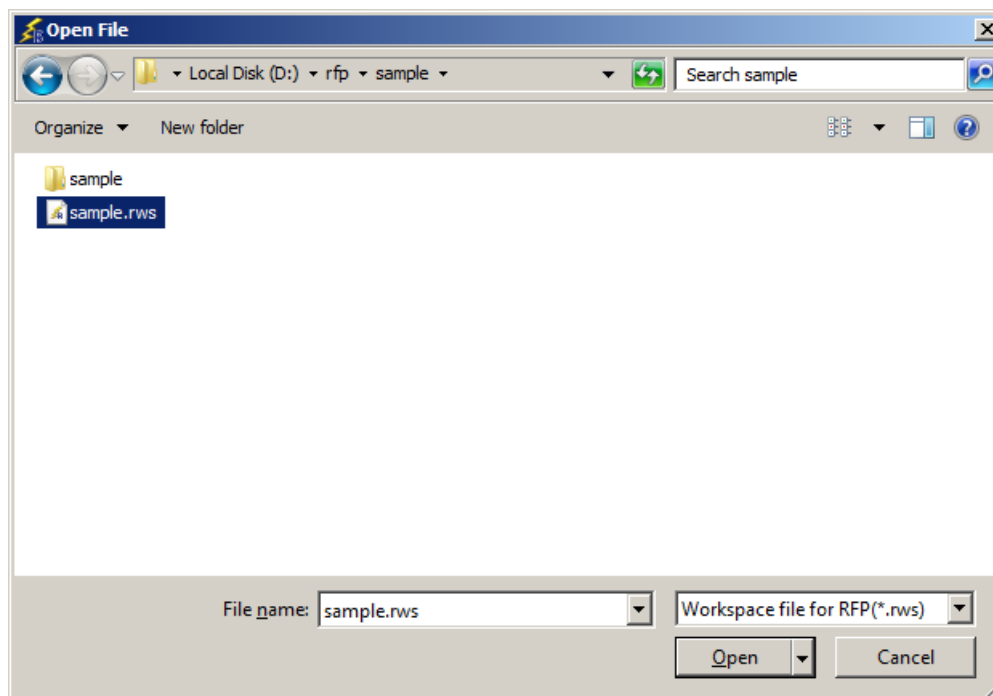
Figure 2-24. [Open File] Dialog Box**(3) [Exit]**

[Exit] terminates RFP. RFP can also be terminated by clicking the [X] button on the right end of the title bar in the main window. When RFP is terminated, various settings are saved in the `rfp.ini` file. Save the project file that has been created.

2.4.2 [Tool] menu

Selecting the [Tool] menu displays the pull-down menu as shown in the figure below.

Figure 2-25. [Tool] Menu

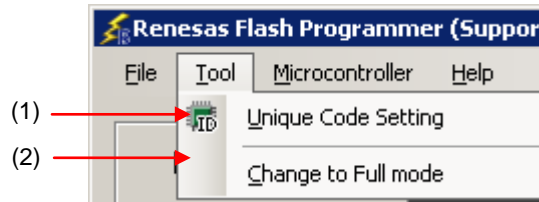

(1) [Unique Code Setting]

Selecting this option displays the [Unique Code Setting] dialog box, in which you make settings for imbedding unique codes. Save the project file that has been created. For the items in the dialog box, refer to **Common Chapter 4**.

Figure 2-26. [Unique Code Setting] Dialog Box

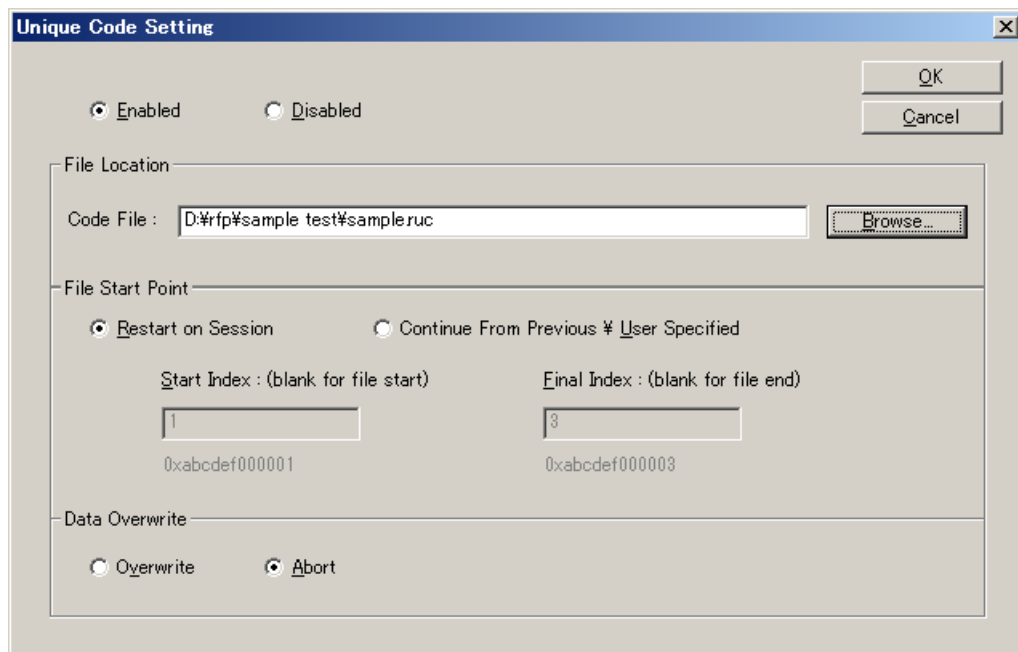

(2) [Change to Full mode]

Selecting this option switches the mode from basic to full. Save the project file that has been created. For the full mode features, refer to **Chapter 3**.

Caution This menu is grayed out when a device is connected. To enable this menu, execute [Disconnect To Device].

2.4.3 [Microcontroller] menu

The following pull-down menu appears by selecting the [Microcontroller] menu. This menu is used for selection and setting of commands such as disconnection from a device, all erase, and program. If you select a command, the check mark is displayed at the left of the command, and the command is assigned to the [Start] button. Note that [Disconnect to Device] and [Set Project] commands are not assigned to the [Start] button.

Figure 2-27. [Microcontroller] Menu

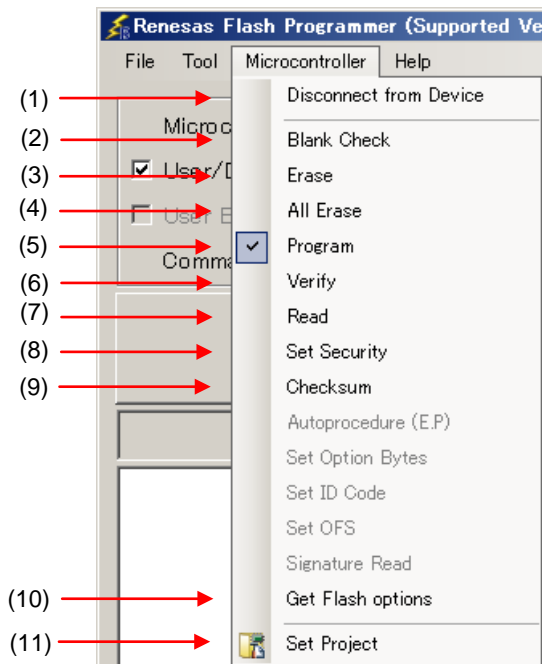

(1) [Disconnect To Device]

This command is used to disconnect from the device, and shut off the power supply if the [Power target from the emulator] check box is selected in the [Power Supply] dialog box.

(2) [Blank Check] command

This command executes blank check on all flash memory blocks.

(3) [Erase] command

This command erases the specified flash memory block. Executing the [Erase] command opens the [Erase] dialog. The blocks whose checkboxes are selected will be erased. The [Erase] command is executed in accordance with the settings of [Erasure Permission] of the [User Boot Area Options] category in the [Other Settings] tab of the [Project Settings] dialog box. Refer to 2.4.3. (11) (f) <12> [User Boot Area Options] category for details.

Figure 2-28. [Tree] Tab of [Erase] Dialog Box

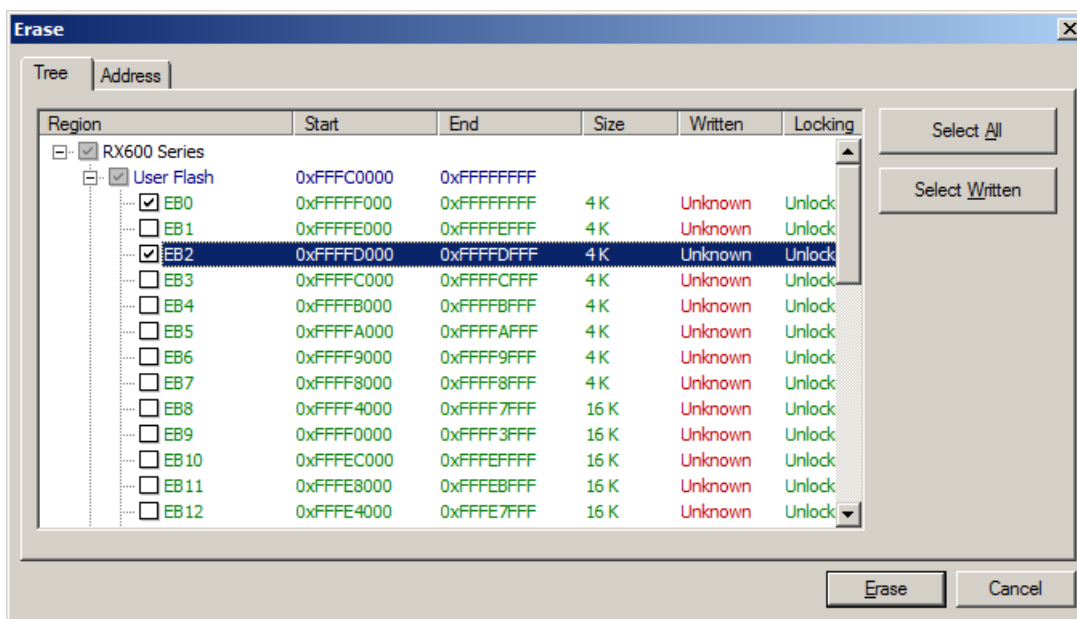

- Clicking the **Select All** button selects all blocks for erasure.
- Clicking the **Select Written** button selects all blocks that have been programmed for erasure.
- Clicking the **Erase** button selects the specified block for erasure.
- Clicking the **Cancel** or **X** button returns you to the main window without erasing a block.

Figure 2-29. [Address] Tab of the [Erase] Dialog Box

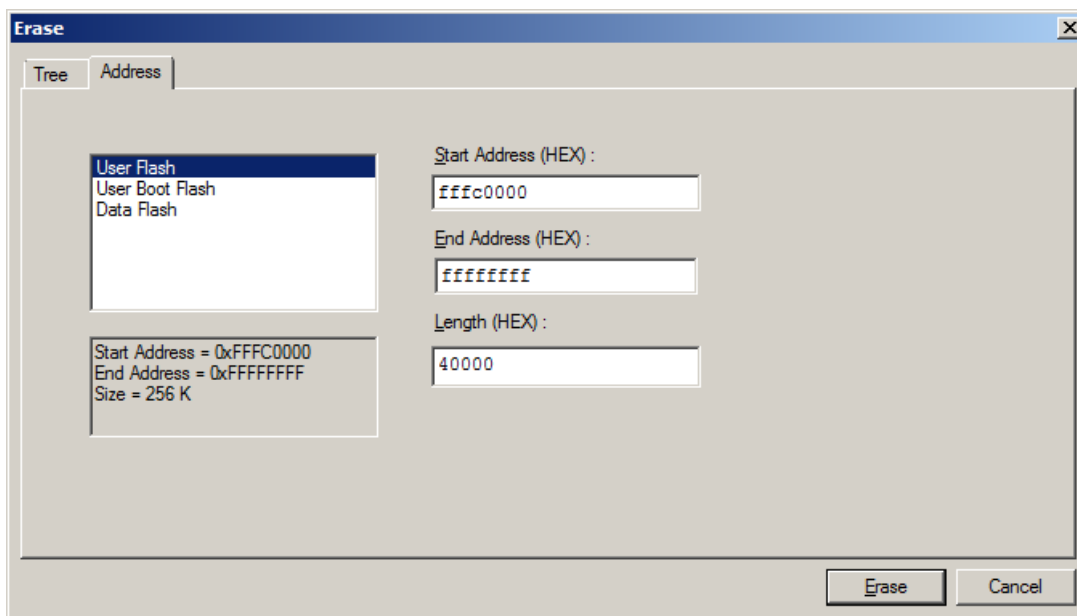

Specify each erasing target area by entering the start address and the end address, or by entering the start address and the data length.

- Clicking **Erase** leads to erasing of the data from the specified address range.
- Clicking **Cancel** or **X** closes the dialog box without performing erasing.

(4) [All Erase] command

This command is used to erase all blocks of the flash memory. The operation of the [All Erase] command is subject to the setting of [Erasure Permission] of the [User Boot Area Options] category in the [Other Settings] tab of the [Project Settings] dialog box. For details, see 2.4.3 (11) (f) <12>, [User Boot Area Options] category.

(5) [Program] command

This command is used to write the program file selected in the program file area to the flash memory. When programming is complete, the result is displayed. The operation options related to the [Program] command are according to the settings of [All Erase Before Program], [Verify After Program], [Checksum After Program], [Security After Program], and [File Over Warning] in the [Command Options] category of the [Other Settings] tab in the [Project Settings] dialog box. For details, see 2.4.3 (11) (f) <8> [Command Options] category.

Remark When the [Program] command is executed, programming is performed after the block with data is erased. To erase all blocks, set [All Erase Before Program] in the [Command Options] category in the [Other Settings] tab of the [Project Settings] dialog box to “True.”

(6) [Verify] command

This command is used to verify that the data written to the flash memory is the same as the data in the program file selected in the program file area.

(7) [Read] command

This command reads the specified flash memory block. Executing the [Read] command opens the [Save As] dialog box.

Figure 2-30. [Save As] Dialog Box

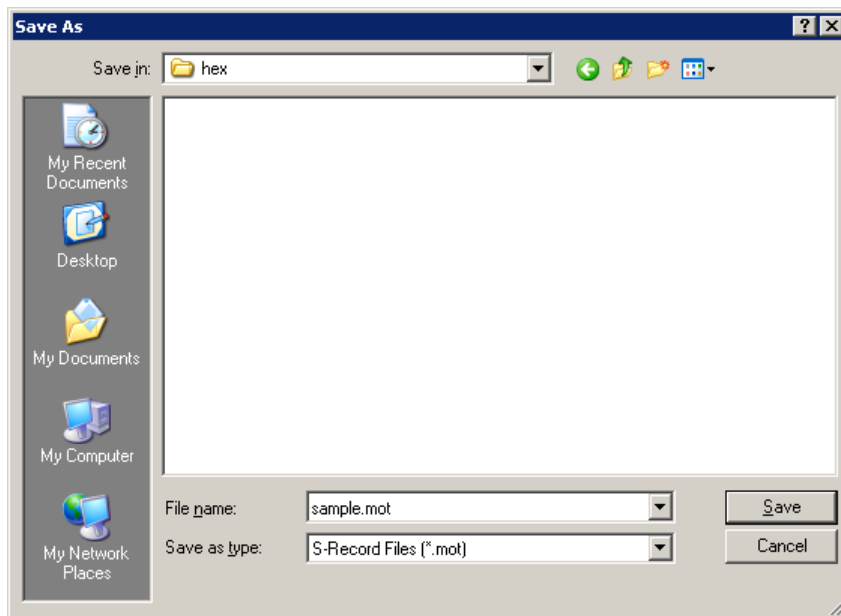

Enter a filename in the [File name:] box. A saving format "S-Record File (*.mot)" is specified in the [Save as type:] list box.

Clicking [Save] specifies the file name, closes the dialog box, and opens the [Read] dialog box. The dialog box has the [Tree] tab and the [Address] tab. Selecting either of them determines how you specify the item to be read.

Clicking [Cancel] or [x] closes the dialog box without specifying the file name.

Figure 2-31. [Tree] Tab of the [Read] Dialog Box

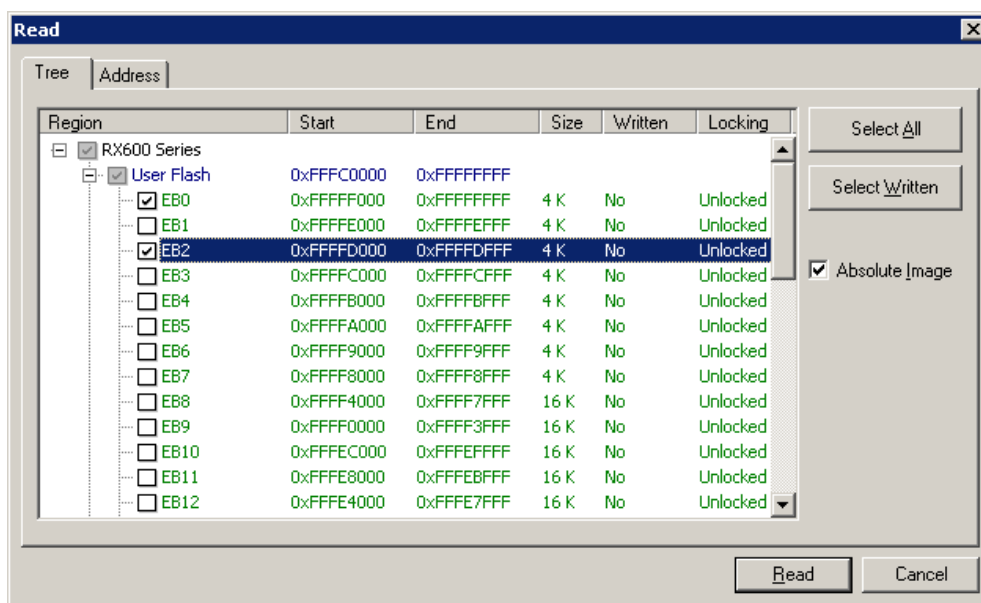

The blocks with boxes under the Region column checked are read.

[Absolute Image] checkbox

Checked: When the read data are saved to a file, the data are saved at the address in flash memory from which the data were read out.

Not checked: When the read data are saved to a file, the data are saved in the address range starting from address 00h.

Clicking [Select All] selects all blocks for reading.

Clicking [Select Written] selects all blocks that have been programmed for reading.

Clicking [Read] leads to reading of the selected blocks and saving of the contents in a file when the process ends normally.

Clicking [Cancel] or [x] closes the dialog box without performing reading.

Figure 2-32. [Address] Tab of the [Read] Dialog Box

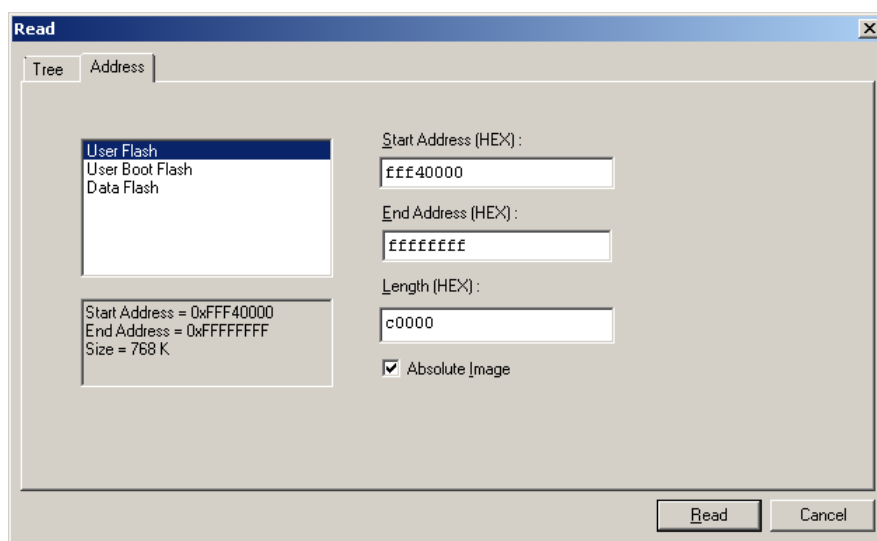

Specify each reading target area by entering the start address and the end address, or by entering the start address and the data length.

[Absolute Image] checkbox

Checked: When the read data are saved to a file, the data are saved at the address in flash memory from which the data were read out.

Not checked: When the read data are saved to a file, the data are saved in the address range starting from address 00h.

Clicking [Read] leads to reading of the data from the specified address range and saving of the contents in a file when the process ends normally.

Clicking [Cancel] or [x] closes the dialog box without performing reading.

(8) [Set Security] command

This command is used to set security of the target microcontroller. When the [Set Security] command is executed, the contents that are set in the [Security Setting (Flash Shield Window)] category in the [Other Settings] tab of the [Project Settings] dialog box are reflected to the target microcontroller. For details of settings including the security settings, see 2.4.3 (11) (f) <14> [Security Setting (Flash Shield window)] category.

(9) [Checksum] command

This command reads the checksum calculated in the target microcontroller and displays it on the output panel.

Checksums are calculated as follows:

Calculation method: 32-bit sum method

Calculation scope: The user area, the user boot area, and the data area

Figure 2-33. Output Panel after Execution of [Checksum] Command

```
Getting the checksum of the device
Checksum of the flash: 0x03FC0000 User Flash
Checksum of the flash: 0x003FC000 User Boot Flash
Checksum of the flash: 0x0048AAC4 Data Flash
```

Remark 32-bit addition is the eight lower-digit of the result of adding the value of all bytes in the flash memory.

(10)[Get Flash options] command

This command is used to read the contents of the flash options settings of the target microcontroller. The read results are reflected to the [Security Setting (Flash Shield Window)] category in the [Other Settings] tab of the [Project Settings] dialog box and displayed. When this command is executable, the flash options settings can be verified by executing this command before executing the [Set Security] command. For details of flash options settings, see 2.4.3 (11) (f) <14> [Security Setting (Flash Shield window)] category.

Figure 2-34. [Get Flash options] Command

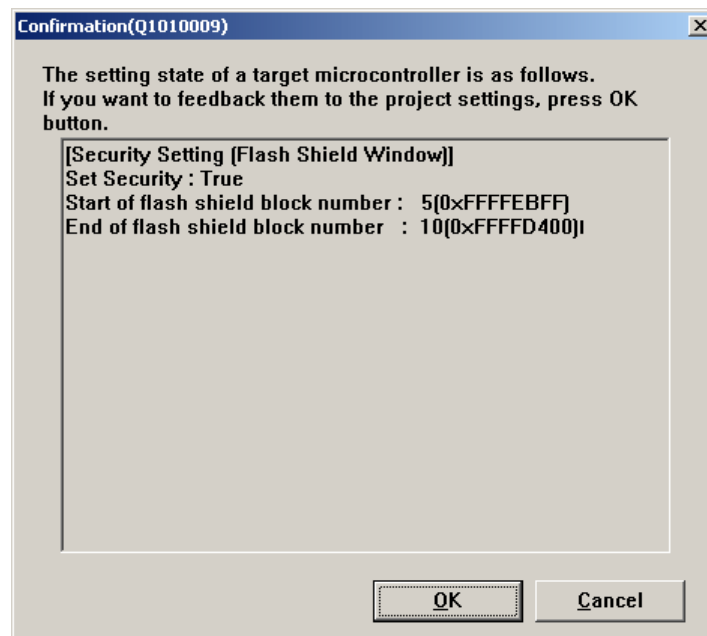

(11) [Set Project]

When [Project Settings] is selected, the [Project Settings] dialog box is displayed, and you can check and change project settings. You can select [Basic Settings] tab or [Other Settings] tab, each of which presenting its specific category of settings. When the [Modify...] button in the [Basic Settings] is clicked, the [Communication Interface] dialog box is displayed, and you can change the settings in the wizard format (refer to **Figure 2-35**). The [Communication Speed] dialog box is not displayed when USB Direct is selected. The [Power Supply] dialog box is displayed when E1 is selected. The [Mode Pins] dialog box is displayed when E1 or E20 and 2 wire UART is selected.

Figure 2-35. Flow of Setting Change with the [Modify...] Button

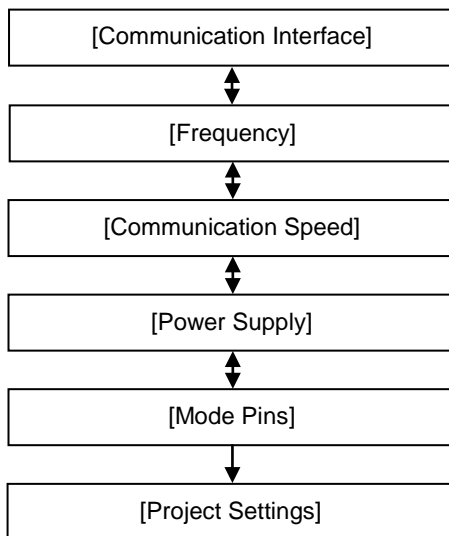

(a) [Communication Interface] dialog box

This dialog box is used to select the tool used and the port used for communication between the selected tool and the target microcontroller.

Figure 2-36. [Communication Interface] Dialog Box

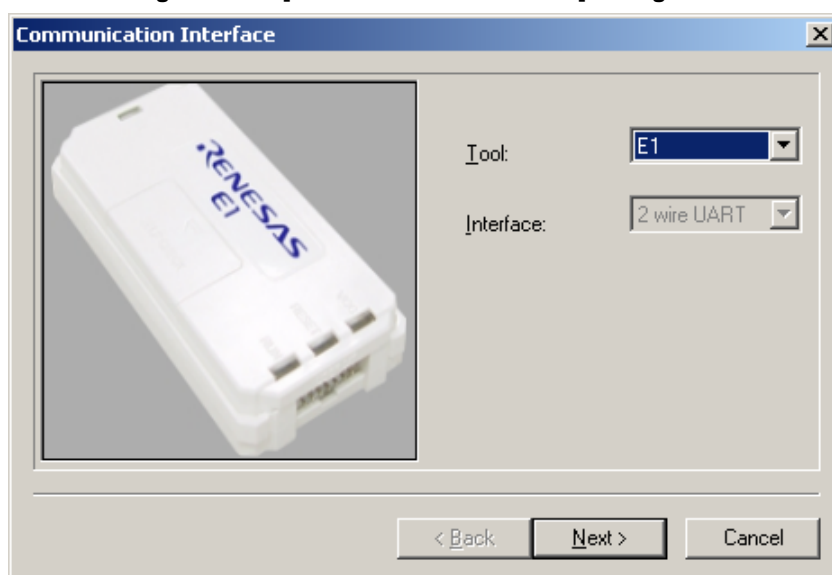

For details about each item, see 2.2.3.

Clicking the [Next >] button displays the next dialog box.

Clicking the [Cancel] or the [X] button returns you to the [Project Settings] dialog box.

(b) [Frequency] dialog box

This dialog box is used to set clock supply and multiplication ratios for the main clock and peripheral clock.

Figure 2-37. [Frequency] Dialog Box

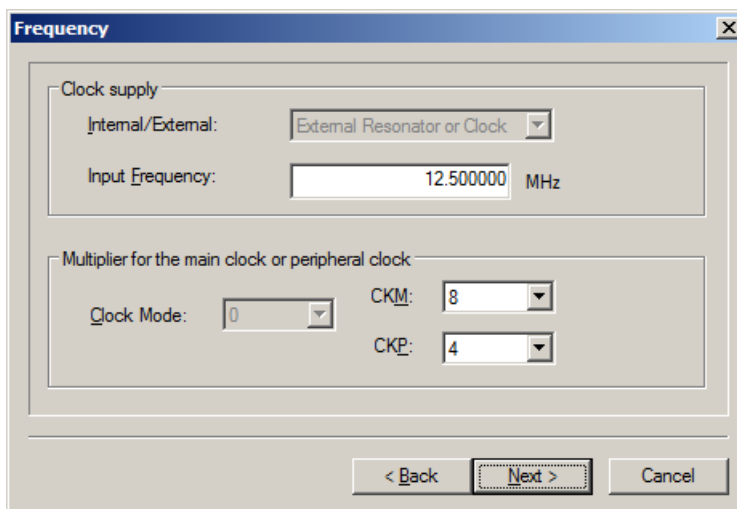

For details about each item, see 2.2.7.

Clicking the < Back button displays the previous dialog box.

Clicking the Next > button displays the next dialog box.

Clicking the Cancel or the X button returns you to the [Project Settings] dialog box.

(c) [Communication Speed] dialog box

This dialog box is used to set communication speed.

Figure 2-38. [Communication Speed] Dialog Box

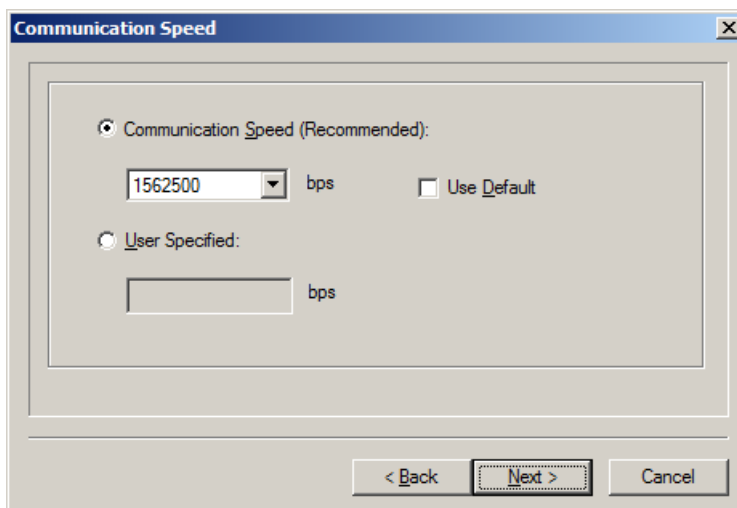

For details about each item, see 2.2.8.

Clicking the < Back button displays the previous dialog box.

Clicking the Next > button displays the next dialog box.

Clicking the Cancel or the X button returns you to the [Project Settings] dialog box.

(d) [Power Supply] dialog box

This dialog box is used to set power supply for the target system.

Figure 2-39. [Power Supply] Dialog Box

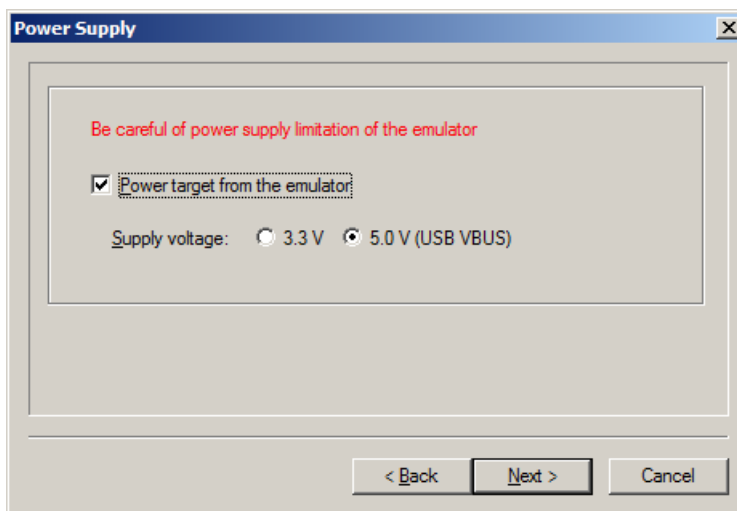

For details about each item, see 2.2.4.

Clicking the < Back button displays the previous dialog box.

Clicking the Next > button displays the next dialog box.

Clicking the Cancel or the X button returns you to the [Project Settings] dialog box.

(e) [Mode Pins] dialog box

This dialog box is used to select the pin to control the mode pin of the target microcontroller from io0 to io5 pins.

Figure 2-40. [Mode Pins] Dialog Box

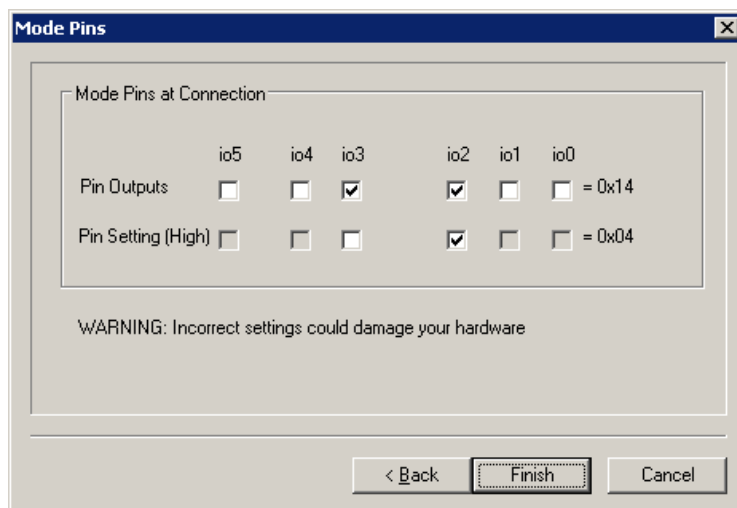

Remark For the io0 to io5 pins of E1 and E20, refer to **Common APPENDIX B Figure B-1. E1 and E20 Pins - RX -**.

For details about each item, see 2.2.5.

Clicking the < Back button displays the previous dialog box.

Clicking the Finish button saves the workspace file and returns you to the [Project Settings] dialog box.

Clicking the Cancel or the X button returns you to the [Project Settings] dialog box.

(f) [Project Settings] dialog box

This dialog box is used to check and change the project settings. It has the [Basic Settings] tab and [Other Settings] tab. Selecting a tab changes the categories in which settings are displayed.

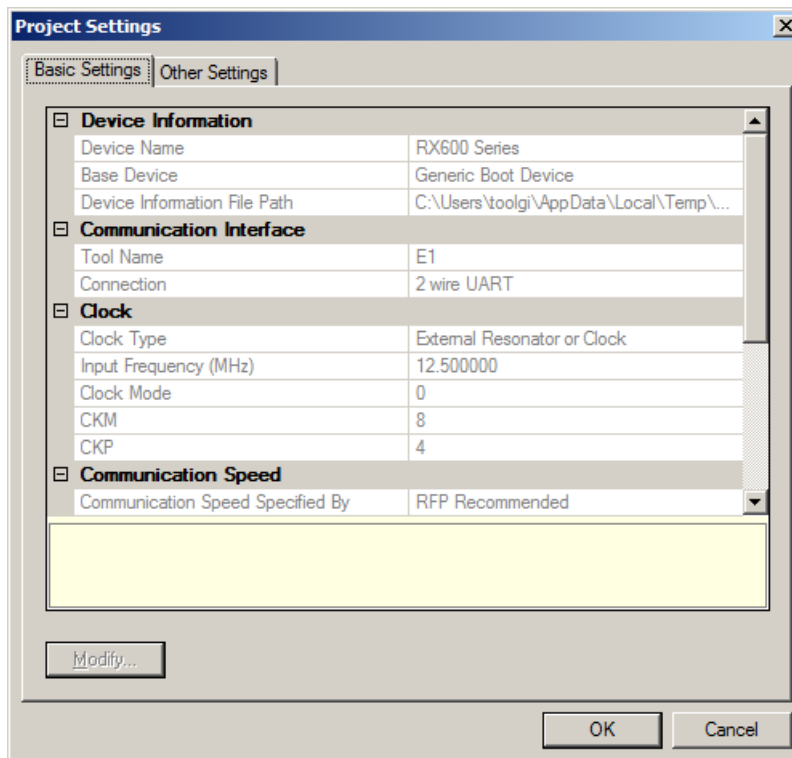
Figure 2-41. [Project Settings] Dialog Box

[Basic Settings] tab

- <1> [Device Information] category
- <2> [Communication Interface] category
- <3> [Clock] category
- <4> [Communication Speed] category
- <5> [Target Power] category
- <6> [Mode Pins At Connection] category

[Other Settings] tab

- <7> [Basic Mode Option] category
- <8> [Command Options] category
- <9> [Mode Pins At Disconnection] category
- <10> [ID Code Authentication] category
- <11> [Timeout Option] category
- <12> [User Boot Area Options] category
- <13> [Lock Bit] category
- <14> [Security Setting (Flash Shield Window)] category

Clicking the **Modify...** button displays the [Communication Interface] dialog box.

Clicking the **OK** button saves the project file and returns you to the main window.

Clicking the **Cancel** or the **X** button returns you to the main window.

<1> [Device Information] category

This category displays information about the microcontroller such as Device Name, Base Device, and Device Information File Path.

Device Name	Displays the device name.
Base Device	Displays the base device of the device.
Device Information File Path	Displays the parameter file path of the device.

<2> [Communication Interface] category

This category displays Tool and Connection.

Tool Name	Displays the communication tool between the target board and host PC.
Connection	Displays the connection method between the target board and host PC.

<3> [Clock] category

This category displays clock-related information such as Clock Type, Frequency, CKM, and CKP.

Clock Type	Clock is supplied to the device via internal or external clock.
Input Frequency (MHz)	Displays the input frequency of the device.
Clock Mode	Displays the clock mode of the device.
CKM	Displays the multiplication or frequency dividing of the main clock.
CKP	Displays the multiplication or frequency dividing of the peripheral clock.

<4> [Communication Speed] category

This category displays communication speed-related information such as Communication speed Specified By, Communication speed Value (bps), and Use Default Value.

Communication speed Specified By	Displays the communication speed based on the Recommended Speeds or User Specified.
Communication speed Value (bps)	Displays the communication speed with the device.
Use Default	Displays if the recommended default communication speed is used or not.

<5> [Target Power] category

This category displays Power Supply of the target device.

Supply Power	Displays the power supply for the target device.
--------------	--

<6> [Mode Pins at Connection] category

This category displays the state of the mode pin to start the device in the boot mode when it is connected.

Mode Pin Information	Displays the state of the mode pin to start the device in the Boot mode at connection.
----------------------	--

<7> [Basic Mode Option] category

This category is used to select whether or not to automatically disconnect after execution.

Auto Disconnect	Selects whether to disconnect automatically after execution.	
	True	Enabled
	False	Disabled

<8> [Command Options] category

This category is used to select Readback Verification, All Erase Before Program, Request Checksum, and File Over Warning.

All Erase Before Program	Selects whether to erase all blocks before programming.	
	True	Enabled
	False	Disabled
Verify After Program	Selects whether to execute readback verification after programming.	
	True	Enabled
	False	Disabled
Checksum After Program	Selects whether to obtain the checksum of the device after programming.	
	True	Enabled
	False	Disabled
Security after Program	Selects whether to set security after programming.	
	True	Enabled
	False	Disabled
File Over Warning	Selects whether to display the warning dialog when the program file exceeds the ROM size of the flash.	
	True	Enabled
	False	Disabled

Remark The checksum is the eight lower-order digits of the result of adding the values of all bytes in the flash memory.

<9> [Mode Pins At Disconnect] category

This category displays or is used to select Reset Pin As Low, Reset Device, and Mode Pins Information.

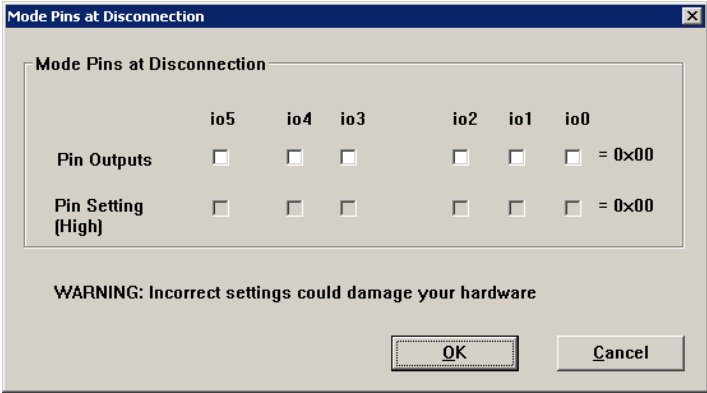
Reset Pin As Low	Selects whether to set the reset pin at Low level when disconnecting from the device.	
	True	The reset pin is set to low level.
	False	The reset pin is set to high impedance.
Reset Device	Selects whether to reset the device when disconnecting from the device.	
	True	Enabled
	False	Disabled
Mode Pins Information	Specifies the mode pin state when resetting the device.	
	 <p>[Pin Outputs] check box Selects the pin to control the mode pin of the target microcontroller from io0 to io5 pins. A selected check box is output, and a cleared check box is input.</p> <p>[Pin Setting (High)] check box Sets the level of the selected io0 to io5 pins to High or Low. A selected check box is High, and a cleared check box is Low. This setting is effective only when the I/O direction is Output.</p>	

Remark For the io0 to io5 pins of E1 and E20, refer to **Common APPENDIX B Figure B-1. E1 and E20 Pins - RX -**.

<10> [ID Code Authentication] category
 This category is used to specify ID code.

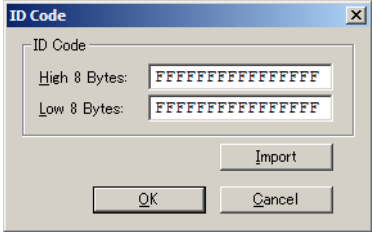
<p>ID Code (Authentication)</p>	<p>Changes the ID code for authentication.</p> <ul style="list-style-type: none"> <Changing the ID code>  <p>[High 8 Bytes:] box Enter the 8 higher order bytes of the ID code.</p> <p>[Low 8 Bytes:] box Enter the 8 lower order bytes of the ID code.</p> <p>[Import] button The [Open] dialog box is opened; when an ID code file in the RFP ID Code File (*.rid)" format is selected, the ID code read from the file will be input to the [ID Code] dialog box.</p> <p>Notes</p> <ol style="list-style-type: none"> For a microcontroller with 8-byte ID code, leave High 8 Bytes blank, or enter 0xFF. If the value of each input field is less than 8 bytes, RFP automatically input 0xFF from the beginning of the field. For a device with control code, enter the value at the first byte of the effective data bytes. <p>Example 1: When Effective data bytes = 16, Control code = H'45, ID code = H'010203, H'04050607, H'08090A0B, H'0C0D0E0F -> 'High 8 Bytes:' 4501020304050607 'Low 8 Bytes:' 08090A0B0C0D0E0F</p> <p>Example 2: When Effective data bytes = 8, Control code = H'45, ID code = H'010203, H'04050607 -> 'High 8 Bytes:' FFFFFFFFFFFFFFFF 'Low 8 Bytes:' 4501020304050607</p> <ul style="list-style-type: none"> <Output to file...> <p>The [Save As] dialog box is opened and the name of an ID code file in the "RFP ID Code Files (*.rid)" format to be created is specified.</p>					
<p>Automatic authentication</p>	<p>This option selects whether or not to send the ID code automatically on ID code authentication.</p> <table border="1" data-bbox="544 1518 1450 1630"> <tr> <td data-bbox="544 1518 751 1554">True</td> <td data-bbox="751 1518 1450 1554">Enables automatic verification of the ID code.</td> </tr> <tr> <td data-bbox="544 1554 751 1630">False</td> <td data-bbox="751 1554 1450 1630">The [ID Code] dialog box is opened on connection to a device to which an ID code has been written.</td> </tr> </table>		True	Enables automatic verification of the ID code.	False	The [ID Code] dialog box is opened on connection to a device to which an ID code has been written.
True	Enables automatic verification of the ID code.					
False	The [ID Code] dialog box is opened on connection to a device to which an ID code has been written.					
<p>Save to the project file</p>	<p>This option selects whether or not to save the ID code in the project file.</p> <table border="1" data-bbox="544 1675 1450 1753"> <tr> <td data-bbox="544 1675 751 1711">True</td> <td data-bbox="751 1675 1450 1711">Enables the option.</td> </tr> <tr> <td data-bbox="544 1711 751 1753">False</td> <td data-bbox="751 1711 1450 1753">Disables the option.</td> </tr> </table>		True	Enables the option.	False	Disables the option.
True	Enables the option.					
False	Disables the option.					

<11> [Timeout Option] category

This category is used to specify Timeout for Erase, Timeout for Blank Check, Timeout for Program, and Timeout for Read.

Timeout for Erase (sec)	Specifies the timeout for erasing the device.
Timeout for Blank Check (sec)	Specifies the timeout for checking if the device is blank.
Timeout for Program (sec)	Specifies the timeout for writing data to the device.
Timeout for Read (sec)	Specifies the timeout for reading data from the device.

<12> [User Boot Area Option] category

This category is used to specify whether or not to include the user boot area in the scope of erasure.

Permission of erasure	Specifies whether to include the user boot area in the scope of erasure.	
	True	Included
	False	Not included

<13> [Lock Bit] category

This category is used to specify lock-bit-related settings such as Connect Option, Disconnect Option, and Lock Blocks At Disconnect.

Disconnect Option	Selects whether to set block lock when disconnecting from the device.
	<ul style="list-style-type: none"> • Set • Displays the setting dialog • Do Nothing
Lock Blocks At Disconnect	Changes the lock state of the block when disconnecting from the device.
	<p>The lock bit setting at disconnection is changed to "Locked" or "Unlocked".</p>

<14> [Security Setting (Flash Shield Window)] category

This category is used to set security.

Set Security	Specifies whether to set the flash shield window.	
	True	Set
	False	Not set
Start of flash shield block number	Inputs the starting block of the flash shield window.	
End of flash shield block number	Inputs the ending block of the flash shield window.	

2.4.4 [Help] menu

Selecting the [Help] menu displays the following pull-down menu.

Figure 2-42. [Help] Menu

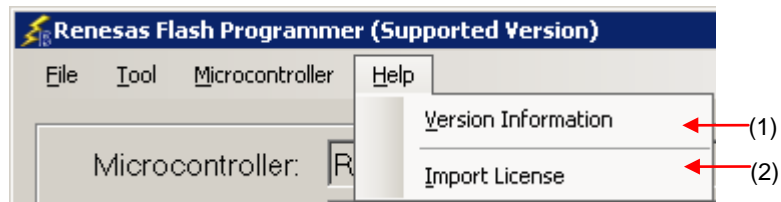

(1) [Version Information]

This is used to open the Version Information dialog box below and display the RFP version. Clicking the [OK] button closes this dialog box.

Figure 2-43. Version Information Dialog Box

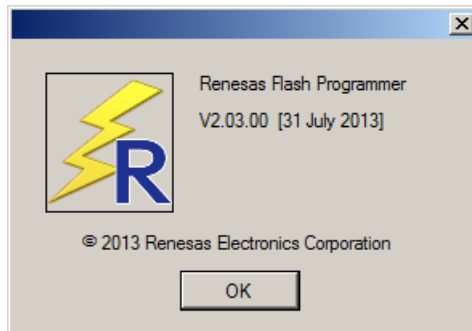

(2) [Import License]

For details of this menu item, see the manual accompanying this product.

2.5 [Microcontroller] Area

This area displays the selected target microcontroller.

Figure 2-44. [Microcontroller] Area



2.6 [Program File] Area

This area displays the selected program file. Clicking the **[Browse...]** button in the User/Data area or the **[Browse...]** button in the User Boot area opens the [Open File] dialog box. Move to a desired folder and select a program file (*.hex;*.mot;*.s*;*.rec). Each item can be enabled by selecting the left check box, or disabled by clearing it.

Figure 2-45. [Program File] Area

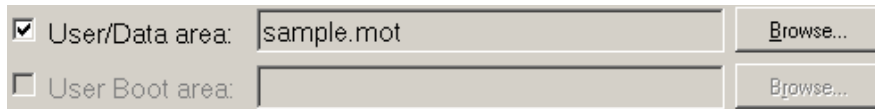
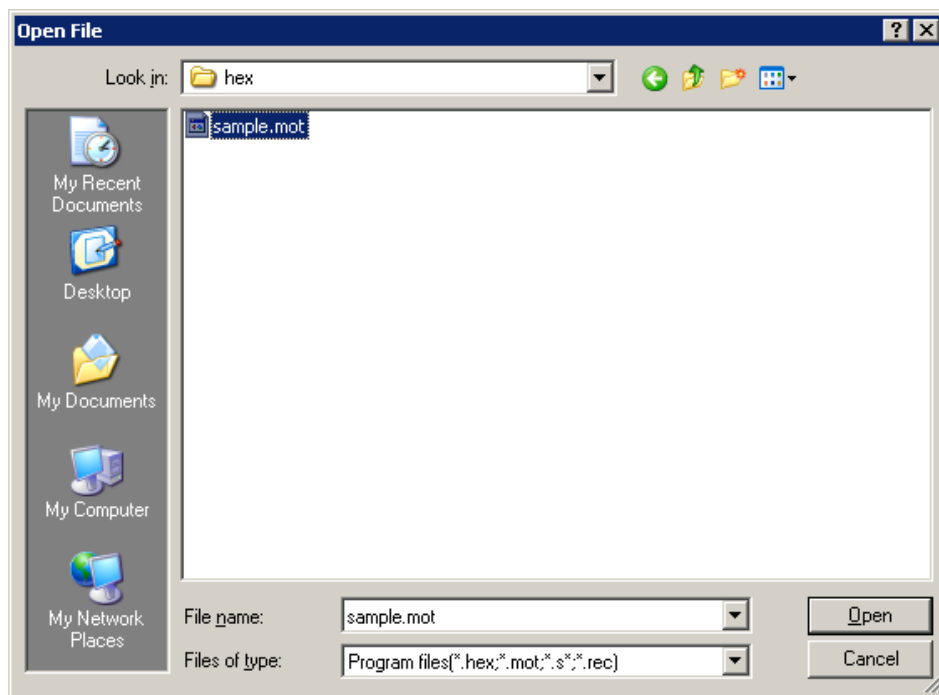

Figure 2-46. [Open File] Dialog Box



2.7 [Command] Area

The command area displays the command selected on the **[Microcontroller]** menu.

Figure 2-47. Command Area

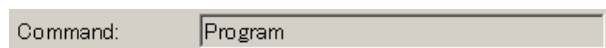

2.8 Start Button

This button executes the command selected on the [Microcontroller] menu. The execution progress is displayed on the output panel or in the [Progress report] dialog box.

Figure 2-48. Start Button



Figure 2-49. [Progress report] Dialog Box

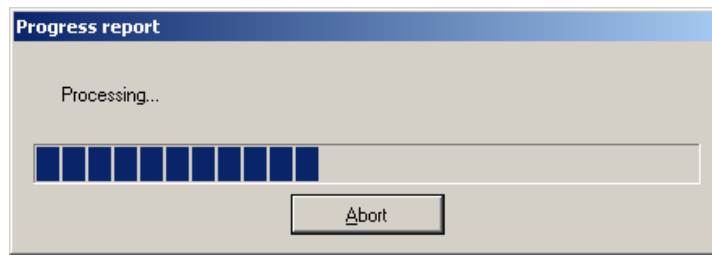

If [Abort] button is clicked during the [Start] button is effective, the command being executed is aborted.

2.9 Status Bar

The status bar shows the progress as a color and with a message when a command selected on the [Microcontroller] menu is executed.

Figure 2-50. Status Bar



Table 2-1 List of Status Bar Display

	Immediately after start of the command, or when the clear button of the output panel is clicked
	During the command execution
	When the command has terminated normally
	When the command has terminated abnormally

2.10 Output Panel

The output panel displays the execution status of the command selected on the [Microcontroller] menu in text. Up to 2000 lines can be displayed. If the text exceeds 2000 lines, lines will be deleted, starting from the first line.

Figure 2-51. Output Panel

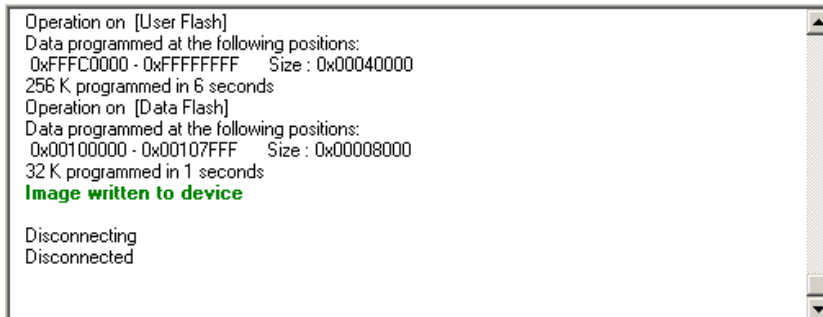

(a) Output Panel Context Menu

Right-clicking the output panel displays a context menu.

Table 2-1 Output Panel Context Menu

<u>C</u> opy	Copies the text selected on the output panel to the clip board.
<u>S</u> elect <u>A</u> ll	Selects the entire text on the output panel.
<u>C</u> lear	Clears the entire text and the status bar display of the output panel.
<u>S</u> ave	Saves the entire text on the output panel to a file. The [Open File] dialog box opens, where you can specify any filename for the file saved.

2.11 Clear Output Panel Button

Clicking the [Clear Output Panel] button will delete all the text displayed on the output panel. The status bar is also cleared.

Figure 2-52. [Clear Output Panel] Button

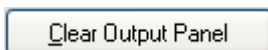

CHAPTER 3 FUNCTION DETAILS (FULL MODE) - RX -

This chapter describes function details of the commands, windows, and dialog boxes of the full mode of RFP.

3.1 Introduction

Make sure that the RFP package is installed. For how to install the RFP package, see **Common CHAPTER 2 INSTALLATION**. Before starting RFP, make sure that the debugger and utility are not running.

3.2 Starting up

On the taskbar, click the [Start] button, point to [All Programs], [Renesas Electronics Utilities], [Programming Tools], [Renesas Flash Programmer Vx.xx], and then click [Renesas Flash Programmer Vx.xx]. The [Welcome!] dialog box will open.

Follow the instructions that appear in the wizard. When setup is finished, the main window is displayed. The [Power Supply], [Mode Pins at Connection], [Frequency] and [Communication Speed] dialog boxes are skipped according to the selected connection method.

Figure 3-1. Flow of Dialog Boxes Until the Program is Activated

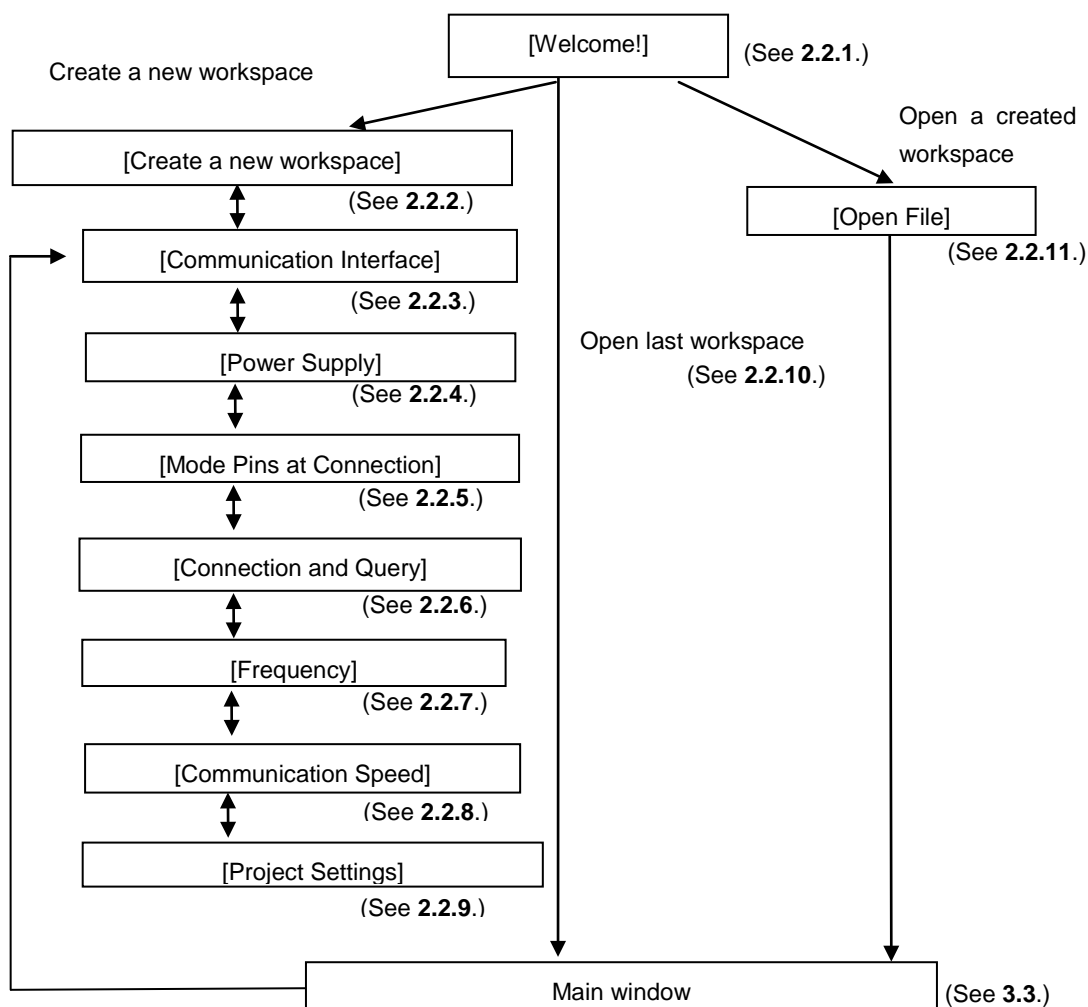

Or a main window is opened by the following method. In the case of (1), the main window of the version installed recently opens.

- (1) Double clicking a workspace file.
- (2) Dragging and dropping a workspace file onto RFP.exe.
- (3) Typing RFP.exe followed by the name of a workspace file at the command prompt and so on; then executing it.

3.3 Main Window

The main window consists of the following items:

Figure 3-2. Main Window

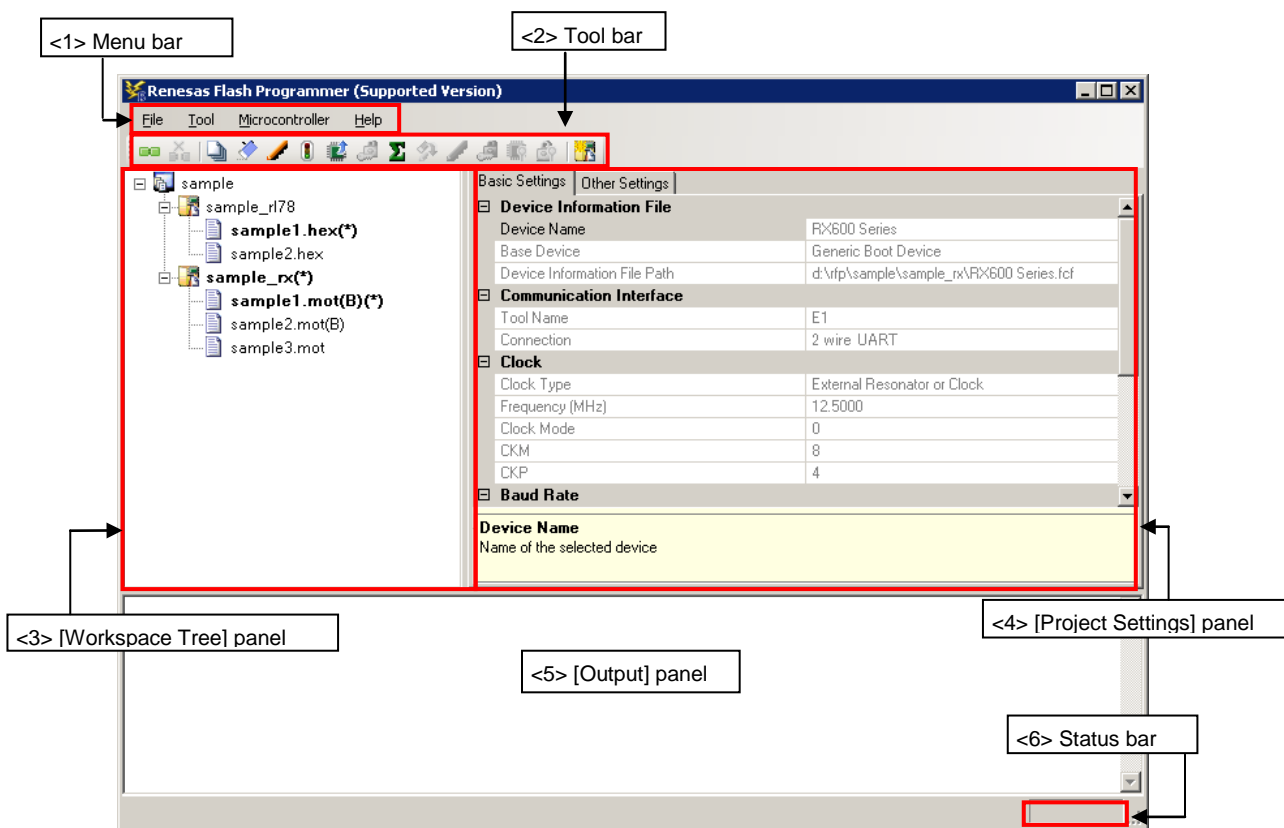

Name	Description	See
<1> Menu bar	Displays the selectable menus.	3.4
<2> Tool bar	Displays buttons for frequently used commands.	3.5
<3> [Workspace Tree] panel	Displays the workspace in a tree form.	3.6
<4> [Project Settings] panel	Displays the project settings.	3.7
<5> [Output] panel	Displays the command execution output.	3.8
<6> Status bar	Displays the command execution status in colors and text	3.9

3.4 Menu Bar

The menu bar consists of [File], [Tool], [Microcontroller], and [Help]. When a menu is selected, the pull-down menu is displayed where the items can be selected. Some items may be disabled depending on the settings.

3.4.1 [File] menu

The following pull-down menu appears by selecting the [File] menu. Refer to 2.4.1 for details of each menu.

Figure 3-3. [File] Menu



3.4.2 [Tool] menu

Selecting the [Tool] menu displays the pull-down menu as shown in the figure below. Refer to 2.4.2 for details of each menu.

Figure 3-4. [Tool] Menu



3.4.3 [Microcontroller] menu

The following pull-down menu appears by selecting the [Microcontroller] menu. You can select a command such as [Disconnect To Device], [All Erase], and [Program], or make settings. Selecting any command executes that command. Selecting [Project Settings] opens a wizard-type dialog box for changing the project basic settings. Refer to 2.4.3 for more information on commands other than [Connect to Device].

Remark The [Set Project] option is deselected while the target microcontroller is connected. To enable the option, select [Disconnect from Device] from the [Microcontroller] pull-down menu.

Figure 3-5. [Microcontroller] Menu

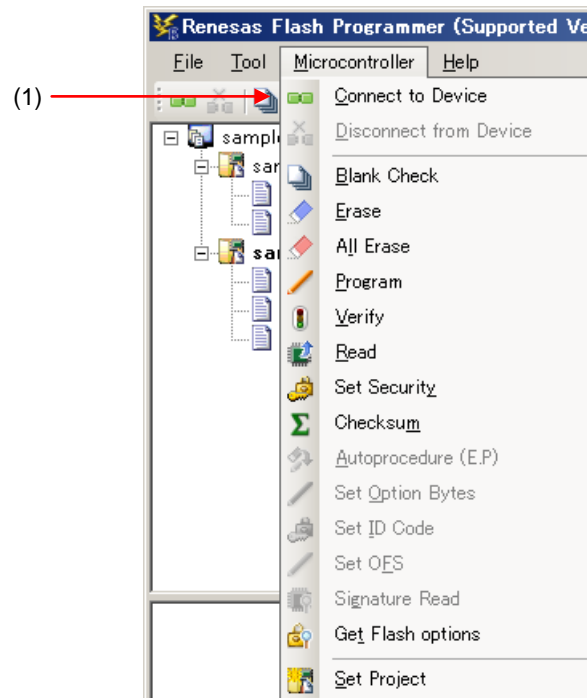

(1) [Connect To Device]

This menu item connects to the device. If the [Power target from the emulator] checkbox of the [Power Supply] dialog is selected, the power supply starts.

3.4.4 [Help] menu

Clicking the [Help] menu displays the following pull-down menu. Refer to 2.4.4 for details of each menu.

Figure 3-6. [Help] Menu

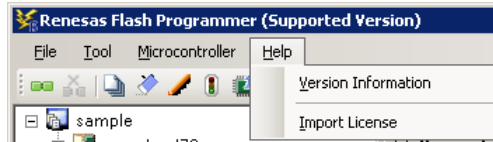

3.5 Tool Bar

The tool bar lists the buttons for the commands of the [Microcontroller] menu. Clicking any of the buttons executes the corresponding command. Some buttons become enabled or disabled depending on the settings. Placing the mouse cursor over a tool bar button displays a tooltip. Refer to 2.4.3 for details of each command.

Figure 3-7. Tool Bar



Table 3-1. Tool Bar

(1)	Executes the [Connect To Device].
(2)	Executes the [Disconnect To Device].
(3)	Executes the [Blank Check] command.
(4)	Executes the [Erase] command.
(5)	Executes the [All Erase] command.
(6)	Executes the [Program] command.
(7)	Executes the [Verify] command.
(8)	Executes the [Read] command.
(9)	Executes the [Set Security] command.
(10)	Executes the [Checksum] command.
(11)	Executes the [Get Flash options] command.
(12)	Opens a wizard-type dialog box for changing the project basic settings. Remark: This button is invalid when the device is connected to a target microcontroller. Select [Disconnect To Device] to enable the button.

3.6 [Workspace Tree] Panel

This panel displays the tree-format representation of the workspace elements (workspace nodes, project nodes, and program file nodes), allowing you to make project operations (such as adding and deleting) and program file operations (such as adding, deleting, and programming).

Figure 3-8. [Workspace Tree] Panel

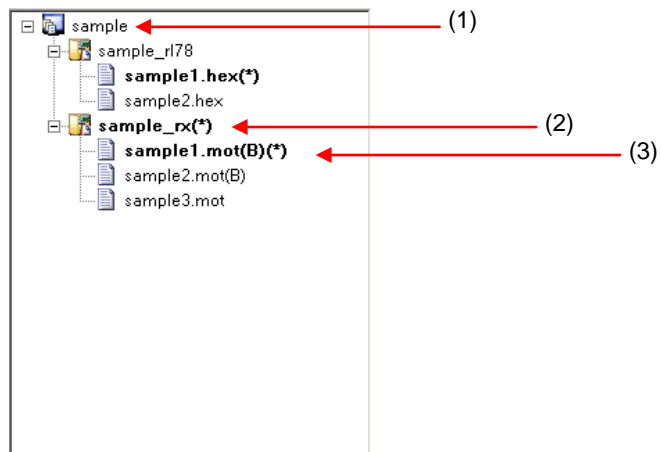

(1) Workspace node

This node represents the workspace currently opened. You cannot open multiple workspaces. The workspace tree has only one workspace node as its root node.

(a) Context menu of the workspace node

Right-clicking the workspace node displays its context menu.

Table 3-2. Context Menu of the Workspace Node

<p>Add Project</p>	<p>This menu item opens the [Create a new workspace] dialog for adding a project in the workspace. The newly added project becomes available for manipulation and edition. The project that has been created is saved.</p>
--------------------	--

(2) Project nodes

A project node represents a project within the workspace. You can manipulate and edit one of the multiple projects (maximum of 64) at a time. The project that can be manipulated and edited is displayed bold and marked by "(*)". Double-clicking one of other project nodes makes it available for manipulation and edition.

(a) Context menu of project nodes

Right-clicking a project node displays its context menu.

Table 3-3. Context Menu of Project Nodes

<u>S</u> et Project Active	Makes the selected project available for manipulation and edition. The project that has been manipulated and edited is saved.
<u>D</u> elete Project	Deletes the selected project from the list. The project file itself is not deleted. This menu item is enabled when the project is not being manipulated or edited.
Add <u>P</u> rogram File	Adds a program file to the selected project. The [Open File] dialog box opens for adding a program file.
<u>M</u> erge Program File	Merges data in all program files added to the selected project and outputs the result as a single program file. The program file is in Motorola S-format HEX format (data record: S3, end record: S7). Note that data in ranges beyond the memory area of the MCU will not be output.

(3) Program file nodes

A program file node represents a program file of a project. A project can have multiple program files (maximum of 64), one of which is available for programming and verification. The program file node available for programming and verification is displayed bold and marked by "(*)". Double-clicking one of other nodes makes it available for programming and verification. Selecting [User Boot Area] from the context menu of a program file node displays the project node bold, and marks the program file node with "(B)".

(a) Context menu of program file nodes

Right-clicking a program file node displays its context menu.

Table 3-4. Context Menu of Program File Nodes

<u>S</u> et Program File Active	Makes the selected program file available for programming and verification.
<u>D</u> elete Program File	Deletes the selected program file from the list. The program file itself is not deleted. This menu item is enabled when the program file is not selected for programming and verification.
Area	Selects an area from the selected program file.
<u>U</u> ser/Data Area	Specifies the area for programming and verification as the User/Data Area.
User <u>B</u> oot Area	Specifies the area for programming and verification as the User boot Area.
<u>P</u> rogram	Executes the [Program] command with the selected program file and area. This menu item is enabled when the project is selected for manipulation and edition, and the program file is selected for programming and verification.
<u>A</u> utoprocEDURE(E.P.)	Not used.

3.7 [Project Settings] Panel

This panel allows you to check and change the project settings. The [Basic Setting] tab and [Other Setting] tab are included in this panel, each of which displays its specific category of settings when selected. Information displayed on this panel is for the project selected for manipulation and edition. Refer to 2.4.3 (11) (f), [Project Settings] dialog for details.

Figure 3-9. [Project Settings] Panel

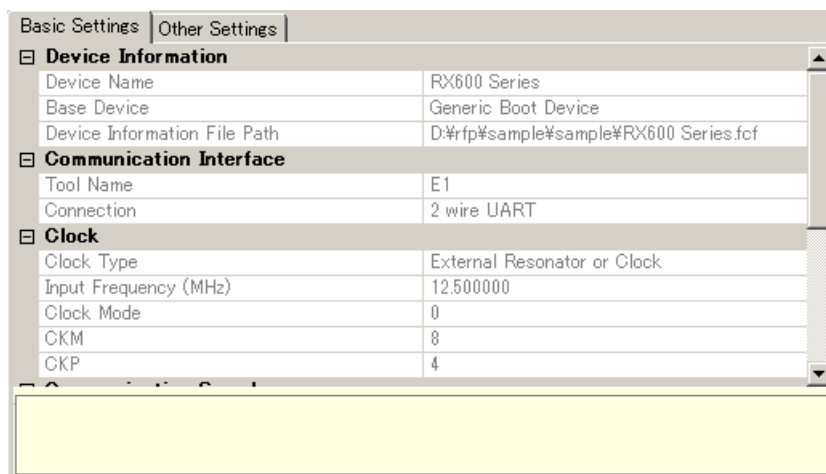

3.8 Output Panel

The output panel displays the execution status of the command selected on the [Microcontroller] menu or the tool bar in text. Up to 2000 lines can be displayed. If the text exceeds 2000 lines, lines will be deleted, starting from the first line. Refer to 2.10 for details.

Figure 3-10. Output Panel



3.9 Status Bar

The status bar shows the progress as a color and with a message when a command selected on the [Microcontroller] menu or the tool bar is executed.

Figure 3-11. Status Bar



Table 3-5. Status Bar Displays

		Immediately after startup, or when [Clear] is selected in the context menu of the output panel
	BUSY	During the command execution
	PASS	When the command has terminated normally
	ERROR	When the command has terminated abnormally

CHAPTER 4 SCRIPT EXECUTION FUNCTION

This chapter explains the script execution function.

4.1 Overview

The script execution function executes the script commands in a script file sequentially without displaying the main window or dialog boxes^{note}. The RFP can be started up and the write command can be executed from the command prompt or user applications.

Note Processing automatically proceeds in response to clicking on button in the [Confirmation] dialog box. Note, however, depending on the settings, a dialog box might be shown while the program is running (see 4.6).

4.2 Start and exit

The script execution starts by the following method. In the case of (1), the main window of the version installed recently starts.

- (1) Double clicking a script file.
- (2) Dragging and dropping a script file onto RFP.exe.
- (3) Typing RFP.exe followed by the name of a script file at the command prompt and so on; then executing it.

After the script execution starts, the script commands in the script file are executed from the first line to the last sequentially. When execution of all commands in the script down to the last line is completed, the result code "0" is returned on exit from the RFP. If there is an error in a command or an error is generated while a command is being executed, the result code "1" is returned immediately and execution of the RFP is terminated. As a note, If there is no script file (*.rsc) or a file that is not a script file (not an *.rsc file) is specified, the script execution function ends and the [Welcome!] dialog box is opened. If an error occurs due to an incorrect command in the script or while a command is being executed, the [Welcome!] dialog box will not open.

RFP.exe xxxx

xxxx: the full path of a script file. If the full path contains spaces, use double quotation marks to enclose the full path ("").

Example) A batch file (sample.bat) example

```
:START
RFP.exe "d:\rfp\sample test\sample.rsc"
ECHO OFF
ECHO Result Code : %ErrorLevel%
PAUSE
```

4.3 Script file

This section describes a script file (file extension, file format, file and example).

(1) File extension

*.rsc

(2) File format

File format: text format

Newline: CR + LF

The only supported character code is ASCII (one byte). Unicode (two bytes) is not supported.

(3) Format

The first line :log command (optional)

The second line :workspace command

The third line and after :arbitrary script command

The lines starting with // are comment lines and will be skipped.

(4) Example

```
//Sample script file
log "d:\rfp\sample test\sample.log"
workspace "d:\rfp\sample test\sample\sample.rws"
programfile d:\hex\sample.mot userdata
serial e1 9jm000129
connect
checksum
disconnect
```

4.4 Script commands

This section describes script commands in a script file. The command interpreter is case-insensitive.

The symbols used to describe the script commands are defined below.

Symbol	Description
Characters within angle brackets < >	Information that must be provided
Characters within square brackets []	Optional information
Slash /	Options where only one option must be selected

Table 4-1 Script Commands

Function	Script command
	Description
Specify a log file	log <filename>
	Specifies a log file. For more details, see 4.5. <filename>: the full path of the log file. If the full path contains spaces, use double quotation marks to enclose the full path (" ").
Specify a workspace	workspace <filename>
	Specifies a workspace file. The script execution function uses an active project and an active program file. <filename>: the full path of the workspace file. If the path contains spaces, use double quotation marks to enclose the path (" ").
Specify a program file	programfile <filename> <area>
	Specifies a program file. When multiple files are specified, the last file is active. <filename>: the full path of the program file. If the path contains spaces, use double quotation marks to enclose the path (" "). <area>: specifies the area (userdata / userboot) userdata: specifies the user and data area. userboot: specifies the user boot area.
Specify an ID code file	idcodefile <filename>
	Specifies an ID code file for authentication. When multiple files are specified, the command is only effective for the last file to be specified. Note that the command leads to the ID code settings in a project file being ignored. <filename>: Use double quotation marks (" ") in cases where the full pathname of the program file is specified or the filename includes a space.
Specify the serial number	serial <connection> <serial_id>
	Specifies the serial number of the tool used. <connection>: specifies the connection method. (e1/ e20/ usb) e1: specifies "E1." e20: specifies "E20." usb: specifies "USB Direct." <serial_id>: When "E1" or "E20" is selected, the serial number marked on the chassis: Example) 9jm000129 When "USB Direct" is selected, the USB port number* : Example) VID_045B&PID_0025\6&3234B9D9&0&3
Wait	wait <time>
	Waits for the specified time. <time>: specifies the wait time (unit: msec, range: 1-2147483647)
Connect to the device	connect
	Executes the connect to the device command.
Disconnect from the device	disconnect
	Executes the disconnect from the device command.

Blank check	<p>blankcheck <area> [<option>]</p> <p>Executes the blankcheck command.</p> <p><area>: specifies the area (user / data/ userboot/ all)</p> <p>user: specifies the user area.</p> <p>data: specifies the data area.</p> <p>userboot: specifies the user boot area.</p> <p>all: specifies all the area.</p> <p>If data or userboot is specified for a microcontroller that does not have a data area or user boot area, the result code "1" is returned.</p> <p><option>: specifies the action (stoponwritten / stoponblank)</p> <p>stoponwritten: if the area specified with <area> is not blank, terminate the script execution function.</p> <p>stoponblank: if the area specified with <area> is blank, terminate the script execution function.</p>
Erase	<p>erase <block></p> <p>Executes the erase command.</p> <p><block>: specifies using either one of the following options.</p> <p>Using block numbers: Example) 0 1 4 7</p> <p>Using block names: Example) EB0 EB1 EB4 EB7</p> <p>written: all written blocks will be erased.</p> <p>device: all blocks will be erased.</p>
Program	<p>program</p> <p>Executes the program command.</p>
Set security	<p>security</p> <p>Executes the set security command.</p>
Verify	<p>verify</p> <p>Executes the verify command.</p>
Checksum	<p>checksum</p> <p>Executes the checksum command.</p>

*) The USB port number is information shown in the device manager when the Generic USB Boot device is connected to the host PC with a USB cable. In the following case, it is "VID_045B&PID_0025\7&91E2848&0&".

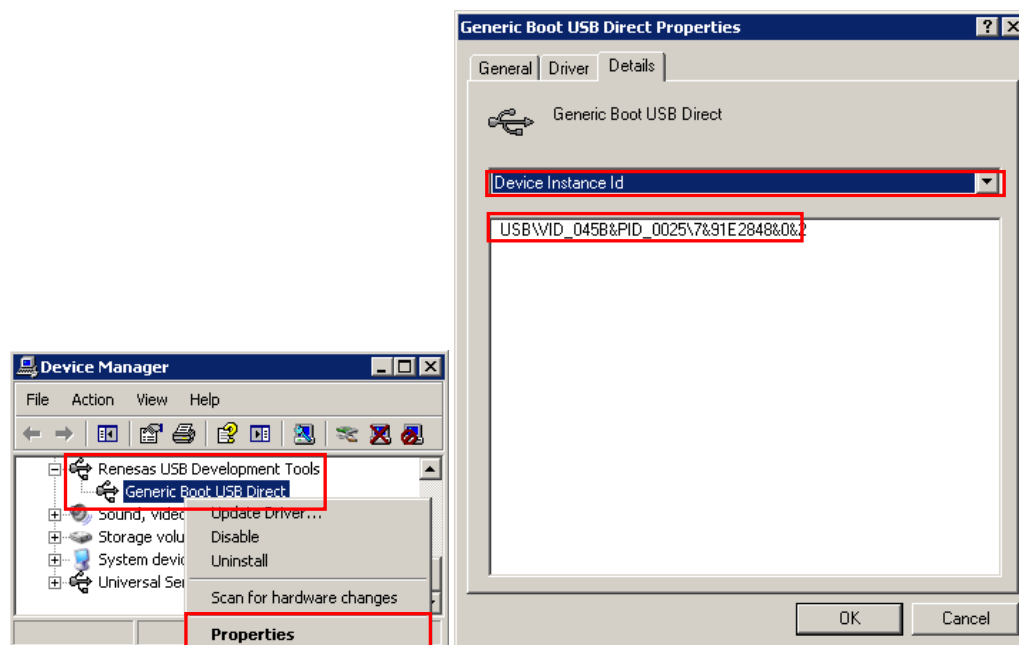

4.5 Log file

Execute the specify a log file script command (log <filename>) by the script command to create a specified log file and to save the script commands and the characters in the output panel to the log file in the text format. If a log file with the same name already exists when a new log file is tried to be created, the existing log file is opened and new log entries are appended after the last line.

(1) Log file format

```
[DD-Mon-YY HH:MM:SS.mmm] ----- Start Script -----
Version
Script
Workspace
[DD-Mon-YY HH:MM:SS.mmm] <script command>
Characters in the output panel
[DD-Mon-YY HH:MM:SS.mmm] ----- End Script -----
```

DD: day (two digits)
 Mon: month (three characters)
 YY: year (two digits)
 HH: hour (two digits)
 MM: minute (two digits)
 SS: second (two digits)
 mmm: millisecond (three digits)

4.6 How to Handle Dialog Boxes Opened while the Program is Running

According to the settings, dialog boxes might be displayed while the program is running. How to deal with the various dialog boxes is covered below.

(1) [ID code] dialog box

<Condition>

When the ID code set in a project and that written in the microcomputer do not match, the [ID Code] dialog box is displayed on connection of the microcomputer.

<Action by the user>

Enter the ID code written in the microcomputer to the [ID Code] dialog box in the [ID Code Authentication] category under the [Other Settings] tab in the [Project Settings]. After that, set [Auto Authentication] to "True".

(2) [Block Locking] dialog box

<Condition>

The [Block Locking] dialog box is displayed on disconnection of a microcomputer that supports lock bits.

<Action by user>

Select either [Set Locks/Unlocks] or [Do Nothing] for [Disconnect Option] in the [Lock Bit] category below the [Other Settings] tab in the [Project Settings] dialog box.

(3) [Confirmation] dialog box

<Condition>

The [Confirmation] dialog box is displayed when the program file exceeds the capacity of the flash ROM at the time of writing.

<Action by user>

Change the setting of [File Over Warning] to "False" in the [Flash Program Options] category under the [Other Settings] tab in the [Project Settings] dialog box.

Renesas Flash Programmer V2.04 User's Manual:
RX100, RX200, RX600 (Except RX64x)

Publication Date: Rev. 1.00 Mar. 31, 2014

Published by: Renesas Electronics Corporation

**SALES OFFICES****Renesas Electronics Corporation**<http://www.renesas.com>Refer to "<http://www.renesas.com/>" for the latest and detailed information.**Renesas Electronics America Inc.**2801 Scott Boulevard Santa Clara, CA 95050-2549, U.S.A.
Tel: +1-408-588-6000, Fax: +1-408-588-6130**Renesas Electronics Canada Limited**1101 Nicholson Road, Newmarket, Ontario L3Y 9C3, Canada
Tel: +1-905-898-5441, Fax: +1-905-898-3220**Renesas Electronics Europe Limited**Dukes Meadow, Millboard Road, Bourne End, Buckinghamshire, SL8 5FH, U.K
Tel: +44-1628-585-100, Fax: +44-1628-585-900**Renesas Electronics Europe GmbH**Arcadiastrasse 10, 40472 Düsseldorf, Germany
Tel: +49-211-6503-0, Fax: +49-211-6503-1327**Renesas Electronics (China) Co., Ltd.**Room 1709, Quantum Plaza, No.27 ZhiChunLu Haidian District, Beijing 100191, P.R.China
Tel: +86-10-8235-1155, Fax: +86-10-8235-7679**Renesas Electronics (Shanghai) Co., Ltd.**Unit 301, Tower A, Central Towers, 555 Langao Road, Putuo District, Shanghai, P. R. China 200333
Tel: +86-21-2226-0888, Fax: +86-21-2226-0999**Renesas Electronics Hong Kong Limited**Unit 1601-1613, 16/F., Tower 2, Grand Century Place, 193 Prince Edward Road West, Mongkok, Kowloon, Hong Kong
Tel: +852-2265-6688, Fax: +852 2886-9022/9044**Renesas Electronics Taiwan Co., Ltd.**13F, No. 363, Fu Shing North Road, Taipei 10543, Taiwan
Tel: +886-2-8175-9600, Fax: +886 2-8175-9670**Renesas Electronics Singapore Pte. Ltd.**80 Bendemeer Road, Unit #06-02 Hyflux Innovation Centre, Singapore 339949
Tel: +65-6213-0200, Fax: +65-6213-0300**Renesas Electronics Malaysia Sdn.Bhd.**Unit 906, Block B, Menara Amcorp, Amcorp Trade Centre, No. 18, Jln Persiaran Barat, 46050 Petaling Jaya, Selangor Darul Ehsan, Malaysia
Tel: +60-3-7955-9390, Fax: +60-3-7955-9510**Renesas Electronics Korea Co., Ltd.**12F., 234 Teheran-ro, Gangnam-Ku, Seoul, 135-920, Korea
Tel: +82-2-558-3737, Fax: +82-2-558-5141

Renesas Flash Programmer V.2.04



Renesas Electronics Corporation

R20UT2908EJ0100