

Adjustable Precision Shunt Regulator

IR9431/IR9431N

T-58-11-23

IR9431/IR9431N Adjustable Precision Shunt Regulator

Description

The IR9431/IR9431N is a shunt regulator IC which adjusts output voltages from 2.5 to 36V through external resistors over the entire operating temperature range. It has a typical dynamic output impedances of 0.2Ω . Active output circuitry provides a very sharp turn-on characteristics making it excellent replacements for zener diodes in many applications.

Features

1. Temperature stability 50ppm/°C (TYP.)
2. Adjustable output voltage
3. Fast turn-on response
4. Low dynamic output impedance 0.2Ω (TYP.)
5. Low output noise voltage
6. 8-pin dual-in-line package (IR9431)
8-pin small-outline package (IR9431N)

Pin Connections

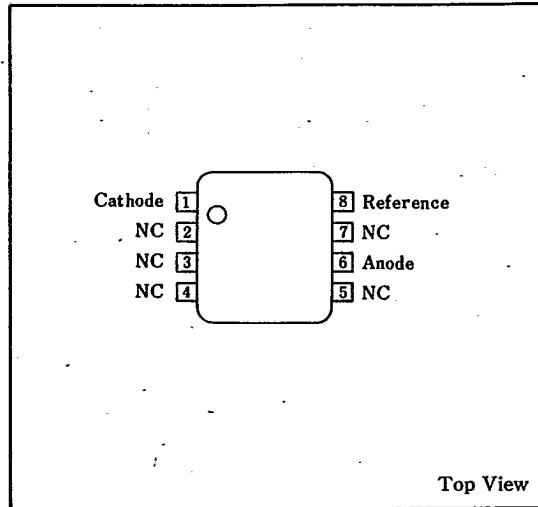

Equivalent Circuit

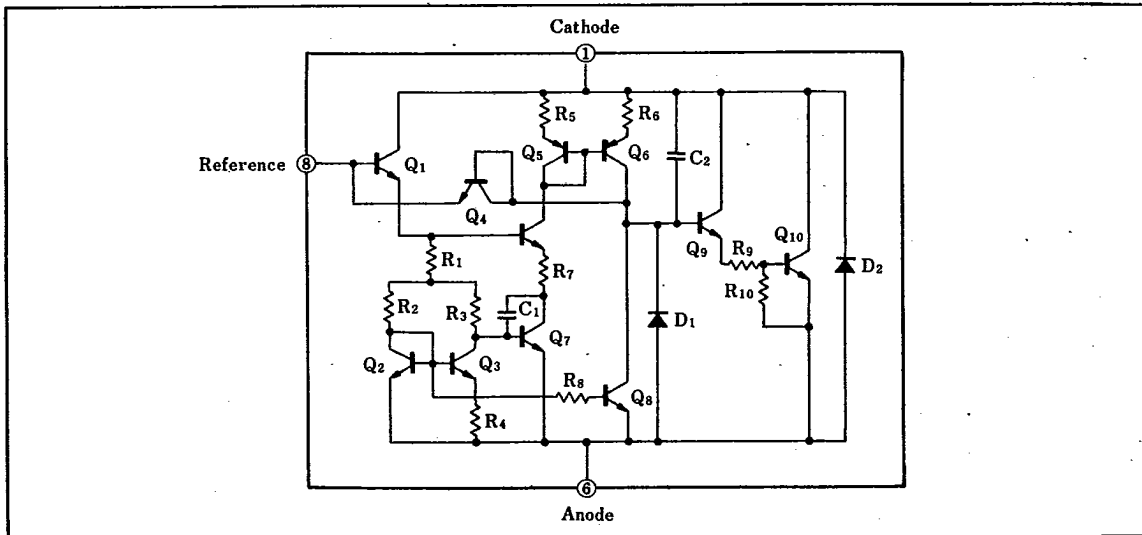

SHARP

229

Adjustable Precision Shunt Regulator

IR9431/IR9431N

Absolute Maximum Ratings

Parameter	Symbol	Condition	Rating	Unit	
Cathode voltage	V_K		37	V	
Cathode current	I_K		-100 ~ +150	mA	
Reference input current	I_{REF}		+0.05 ~ +10	mA	
Power dissipation	P_D	$T_a \leq 25^\circ\text{C}$	IR9431	750	mW
			IR9431N	500	
P_D derating ratio	$\Delta P_D / ^\circ\text{C}$	$T_a > 25^\circ\text{C}$	IR9431	6	mW/°C
			IR9431N	4	
Operating temperature	T_{OPF}		-20 ~ +100	°C	
Storage temperature	T_{STG}		-65 ~ +150	°C	

Recommended Operating Conditions

Parameter	Symbol	Condition	MIN.	TYP.	MAX.	Unit
Cathode voltage	V_K		V_{REF}		36	V
Cathode current	I_K		1		100	mA

Electrical Characteristics

($T_a = 25^\circ\text{C}$)

Parameter	Symbol	Condition	MIN.	TYP.	MAX.	Unit
Reference voltage	V_{REF}	$V_K = V_{REF}, I_K = 10\text{mA}$	2,458	2,495	2,532	mV
Temperature change of reference voltage	$V_{REF(DEV)}$	$V_K = V_{REF}, I_K = 10\text{mA}$ $T_a = \text{full range}$		8	17	mV
Voltage fluctuation of reference voltage	$\frac{\Delta V_{RE}}{\Delta V_K}$	$I_K = 10\text{mA}$	$\Delta V_K = 10\text{V} - V_{REF}$	-1.4	-2.7	mV/V
			$\Delta V_K = 36\text{V} - 10\text{V}$	-1	-2	
Reference input current	I_{REF}	$I_K = 10\text{mA}, R_1 = 10\text{k}\Omega, R_2 = \infty$		2	4	μA
Temperature change of reference current	$I_{REF(DEV)}$	$I_K = 10\text{mA}, R_1 = 10\text{k}\Omega, R_2 = \infty$ $T_a = \text{full range}$		0.4	1.2	μA
Minimum cathode current	I_{MIN}	$V_K = V_{REF}$		0.4	1	mA
OFF-state cathode current	I_{OFF}	$V_K = 36\text{V}, V_{REF} = 0\text{V}$		0.1	1	μA
Dynamic impedance	$ Z_{KA} $	$V_K = V_{REF}, I_K = 1 \sim 10\text{mA}$ $f < 1\text{kHz}$		0.2	0.5	Ω

* Refer to the figure to the right.

$$|\alpha V_{REF}| = \frac{V_{REF(DEV)}}{V_{REF @ 25^\circ\text{C}} \Delta T_a} \cdot 10^6 \quad (\text{ppm}/^\circ\text{C})$$

If the temperature coefficient of reference voltage $V_{REF(DEV)} = 8\text{mV}$ (equation),

$$|\alpha V_{REF}| = \frac{8\text{mV}}{2,495\text{mV}} \cdot 10^6 = 46 \quad (\text{ppm}/^\circ\text{C})$$

dynamic impedance is defined by the following equation.

$$|Z_{KA}| = \frac{\Delta V_K}{\Delta I_K}$$

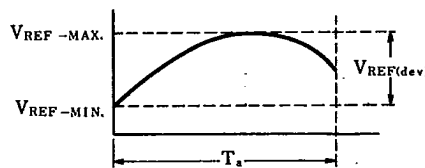

SHARP

Test Circuit

(1) $V_K = V_{REF}$

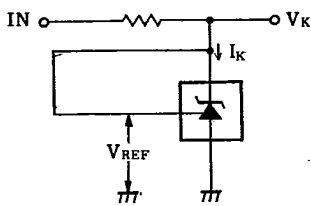

(2) $V_K > V_{REF}$

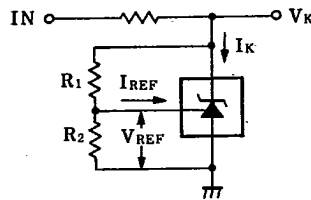

$$V_K = V_{REF} \left(1 + \frac{R_1}{R_2}\right) + I_{REF} \cdot R_1$$

$$|Z| = \frac{\Delta V}{\Delta I} \approx |Z_K| \left(1 + \frac{R_1}{R_2}\right)$$

(3) I_{OFF}

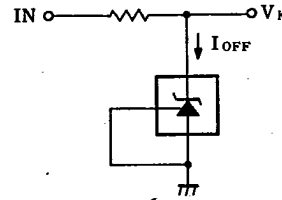

Electrical Characteristic Curves

Cathode current — Cathode voltage Characteristics

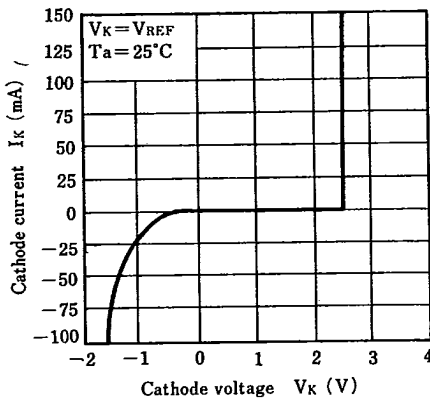

Cathode current — Cathode voltage Characteristics

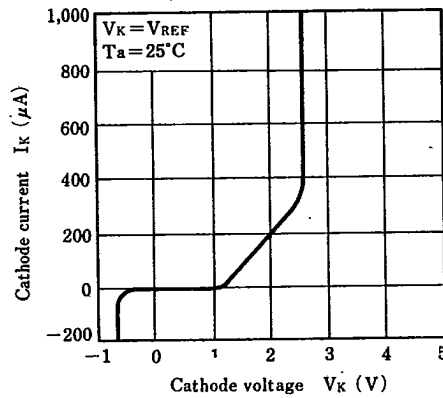

OFF-state cathode current — Operating temperature Characteristics

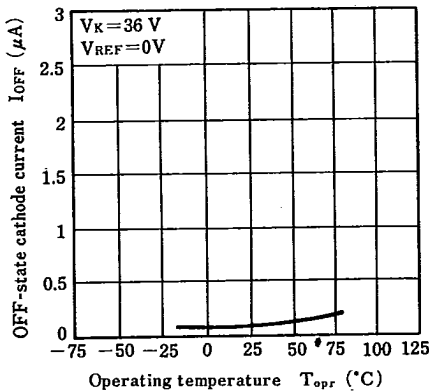

Noise voltage — Frequency Characteristics

