

P-Channel MOSFET

SI2301DS-HF (KI2301DS-HF)

■ Features

- $V_{DS} (V) = -20V$
- $R_{DS(ON)} < 130m\Omega$ ($V_{GS} = -4.5V$)
- $R_{DS(ON)} < 190m\Omega$ ($V_{GS} = -2.5V$)
- Pb-Free Package May be Available. The G-Suffix Denotes a Pb-Free Lead Finish

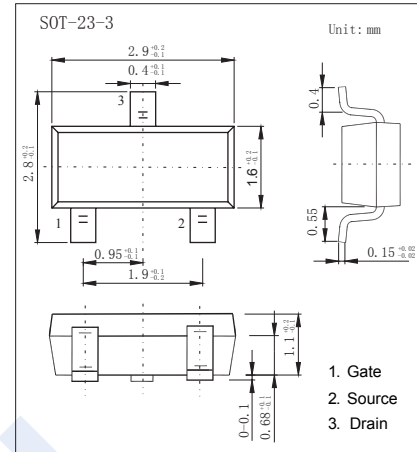
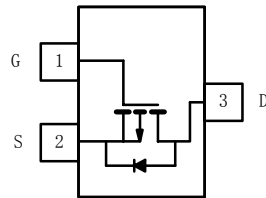

■ Absolute Maximum Ratings $T_a = 25^\circ C$

Parameter	Symbol	Rating	Unit
Drain-Source Voltage	V_{DS}	-20	V
Gate-Source Voltage	V_{GS}	± 8	
Continuous Drain Current *1	I_D	$T_a = 25^\circ C$	A
		$T_a = 70^\circ C$	
Pulsed Drain Current *2	I_{DM}	-10	
Power Dissipation *1	P_D	$T_a = 25^\circ C$	W
		$T_a = 70^\circ C$	
Thermal Resistance.Junction- to-Ambient *1	R_{thJA}	100	$^\circ C/W$
Thermal Resistance.Junction- to-Ambient *3		166	
Junction Temperature	T_J	150	$^\circ C$
Storage Temperature Range	T_{stg}	-55 to 150	

*1 Surface Mounted on FR4 Board, $t \leq 5$ sec.

*2 Pulse width limited by maximum junction temperature.

*3 Surface Mounted on FR4 Board.

P-Channel MOSFET

SI2301DS-HF (KI2301DS-HF)

■ Electrical Characteristics Ta = 25°C

Parameter	Symbol	Test Conditions	Min	Typ	Max	Unit
Drain-Source Breakdown Voltage	V _{DSS}	I _D =-250 μA, V _{GS} =0V	-20			V
Zero Gate Voltage Drain Current	I _{DSS}	V _{DS} =-20V, V _{GS} =0V			-1	μA
		V _{DS} =-20V, V _{GS} =0V, T _J =55°C			-10	
Gate-Body leakage current	I _{GSS}	V _{DS} =0V, V _{GS} =±8V			±100	nA
Gate Threshold Voltage	V _{GS(th)}	V _{DS} =V _{GS} I _D =-250 μA	-0.45		-1	V
Static Drain-Source On-Resistance *1	R _{DS(on)}	V _{GS} =-4.5V, I _D =-2.8A			130	mΩ
		V _{GS} =-2.5V, I _D =-2.0A			190	
On state drain current *1	I _{D(ON)}	V _{GS} =-4.5V, V _{DS} ≤ -5V	-6			A
		V _{GS} =-2.5V, V _{DS} ≤ -5V	-3			
Forward Transconductance *1	g _{FS}	V _{DS} =-5V, I _D =-2.8A		6.5		S
Input Capacitance	C _{iss}	V _{GS} =0V, V _{DS} =-6V, f=1MHz *2		415		pF
Output Capacitance	C _{oss}			223		
Reverse Transfer Capacitance	C _{rss}			87		
Total Gate Charge	Q _g	V _{GS} =-4.5V, V _{DS} =-6V, I _D =-2.8A *2		5.8	10	nC
Gate Source Charge	Q _{gs}			0.85		
Gate Drain Charge	Q _{gd}			1.7		
Turn-On DelayTime	t _{d(on)}	V _{GEN} =-4.5V, V _{DS} =-6V, R _L =6Ω, R _G =6Ω I _D =1.0A *3		13	25	ns
Turn-On Rise Time	t _r			36	60	
Turn-Off DelayTime	t _{d(off)}			42	70	
Turn-Off Fall Time	t _f			34	60	
Continuous Source Current (Diode Conduction)	I _S				-1.6	A
Diode Forward Voltage	V _{SD}	I _S =-1.6A, V _{GS} =0V		-0.8	-1.2	V

*1 Pulse test: PW ≤ 300us duty cycle ≤ 2%.

*2 For DESIGN AID ONLY, not subject to production testing.

*3 Switching time is essentially independent of operating temperature.

■ Marking

Marking	A1* _F
---------	------------------

P-Channel MOSFET SI2301DS-HF (KI2301DS-HF)

■ Typical Characteristics

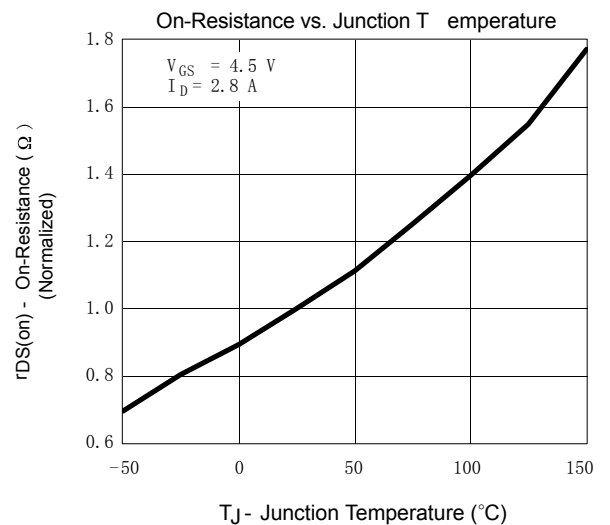
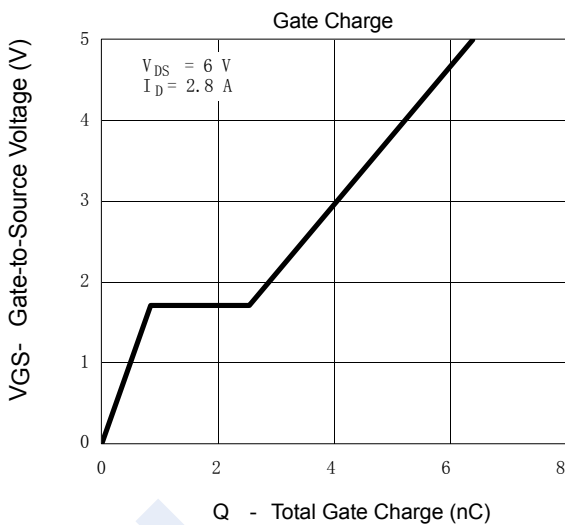
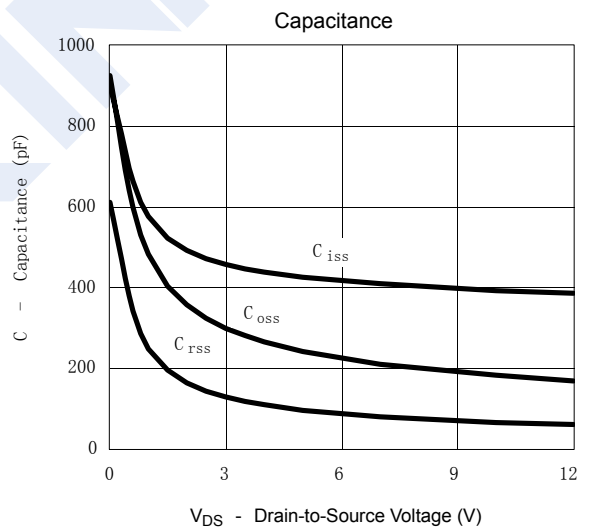
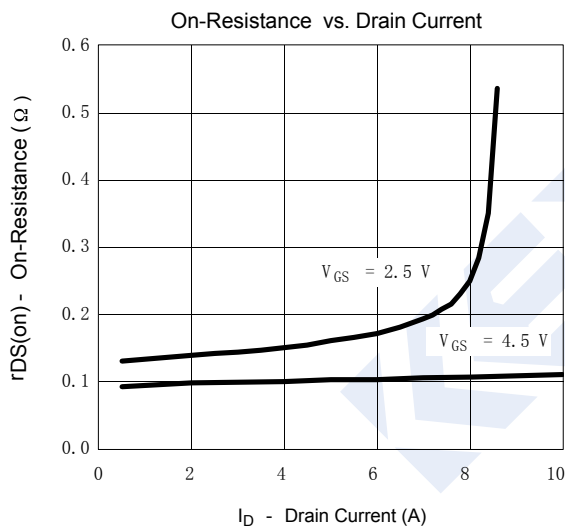
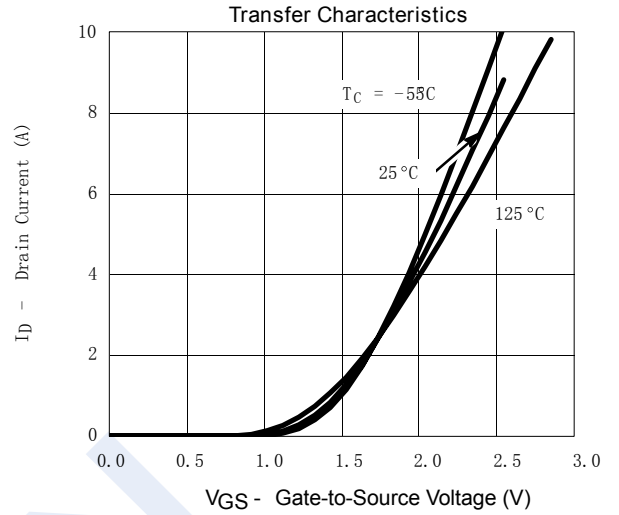
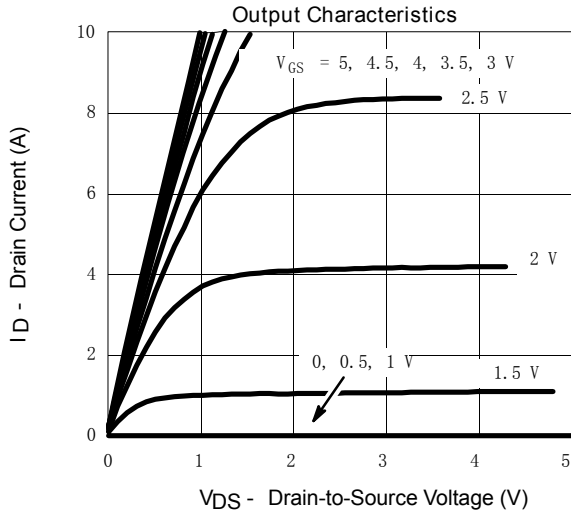

P-Channel MOSFET SI2301DS-HF (KI2301DS-HF)

■ Typical Characteristics

