

Reflective Object Sensor

OPB703 through OPB705, OPB703WZ through OPB705WZ,
OPB70AWZ through OPB70HWZ



Features:

- Phototransistor output
- High sensitivity
- Low-cost plastic housing
- Available with lenses for dust protection and ambient light filtration
- Focused for maximum sensitivity

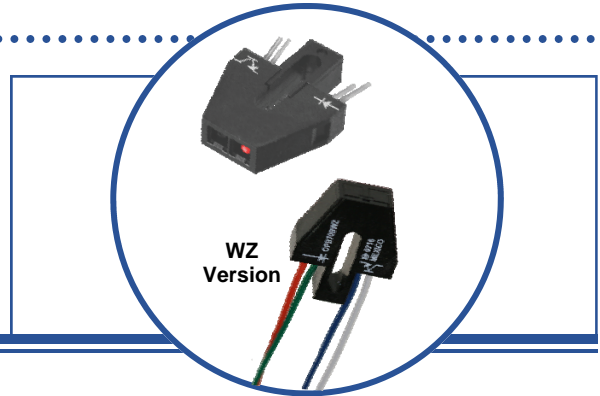

Description:

The **OPB703**, **OPB704** and **OPB705** consist of an Infrared (890nm) Light Emitting Diode (LED) and a NPN silicon Phototransistor, mounted side-by-side on converging optical axes in a black plastic housing and are designed for PCBoard mounting. The **OPB703WZ**, **OPB704WZ**, **OPB705WZ** and **OPB70BWZ** are designed for remote mounting utilizing interconnect wires of UL approved 26 AWG, 24" (61.0cm) minimum length, stripped and tinned.

The **OPB70AWZ** consists of an Infrared (890nm) Light Emitting Diode (LED) and a NPN silicon Photodarlington, mounted side-by-side on converging optical axes in a black plastic housing and is designed for remote mounting utilizing interconnect wires of UL approved 26 AWG, 24" (61.0cm) minimum length, stripped and tinned.

The **OPB70CWZ through OPB70FWZ** consist of a Visible (Red 640nm) Light Emitting Diode (LED) and a NPN silicon Phototransistor or Rbe Phototransistor, mounted side-by-side on converging optical axes in a black plastic housing and are designed for remote mounting utilizing interconnect wires of UL approved 26 AWG, 24" (61.0cm) minimum length, stripped and tinned.

Various lens options are available: No lens for the (**OPB703**, **OPB703WZ**), blue window for dust protection for the (**OPB704**, **OPB704WZ**, **OPB70BWZ**, **OPB70HWZ**) and aperture lens for improved resolution for the (**OPB705**, **OPB705WZ**, **OPB70AWZ**, **OPB70CWZ**, **OPB70DWZ**). The **OPB704G** and **OPB704GWZ** offers excellent protection for dirty environments.

The phototransistor responds to illumination from the emitter when a reflective object passes within the field of view centered typically at 0.15" (3.8 mm).

Custom electrical, wire, cabling and connectors are available. Contact your local representative or OPTEK for more information.

Applications:

- Non-contact reflective object sensor
- Assembly line automation
- Machine automation
- Machine safety
- End of travel sensor
- Door sensor
- Mark Detection
- Office Equipment
- Gaming Equipment

Ordering Information						
Part	LED Peak	Detector	Optical Cover	Lead or Wire		
OPB703	890 nm	Transistor	None	0.160" Leads		
OPB703WZ				24" / 26 AWG Wire		
OPB704			Blue Window	0.160" Leads		
OPB704WZ				24" / 26 AWG Wire		
OPB70HWZ				24" / 26 AWG Wire		
OPB704G				0.160" Leads		
OPB704GWZ				24" / 26 AWG Wire		
OPB705				0.160" Leads		
OPB705WZ			Aperture	Darlington	24" / 26 AWG Wire	
OPB70AWZ						
OPB70BWZ			Blue Window	Rbe Transistor		
OPB70CWZ				Aperture		Rbe Transistor
OPB70DWZ						Transistor
OPB70EWZ				Clear Window		Rbe Transistor
OPB70FWZ	Transistor					



RoHS

OPTEK reserves the right to make changes at any time in order to improve design and to supply the best product possible.

Reflective Object Sensor

OPB703 through OPB705, OPB703WZ through OPB705WZ,
OPB70AWZ through OPB70HWZ



OPB703, OPB704, OPB705

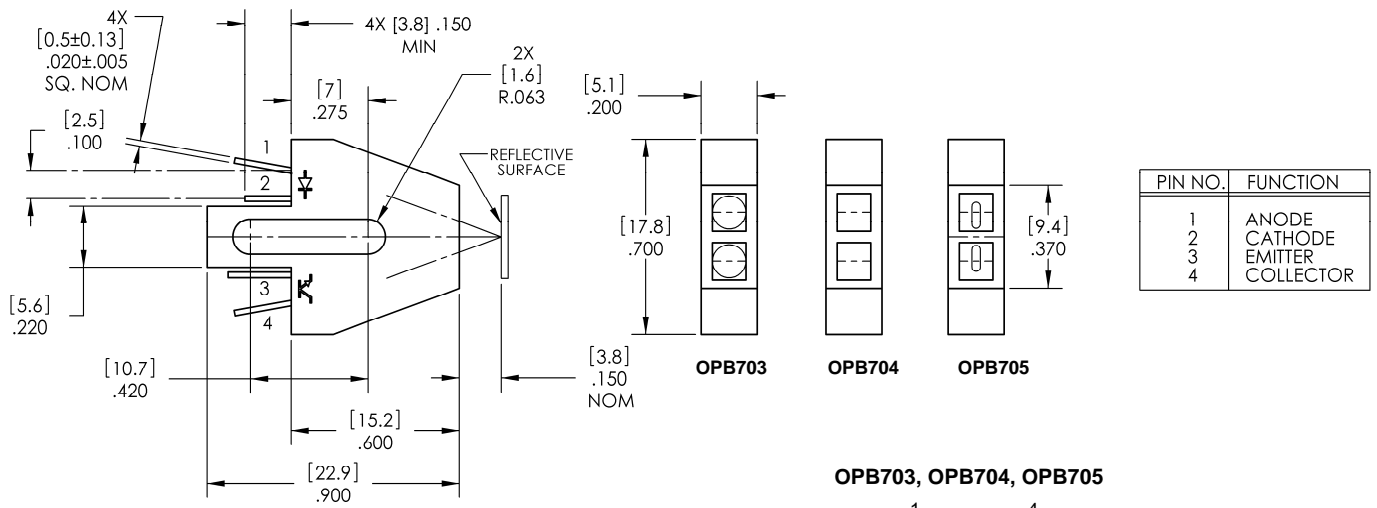

PIN NO.	FUNCTION
1	ANODE
2	CATHODE
3	EMITTER
4	COLLECTOR

DIMENSIONS ARE IN INCHES [MM]
TOLERANCES ARE ± .010 UNLESS OTHERWISE SPECIFIED.

OPB703, OPB704, OPB705

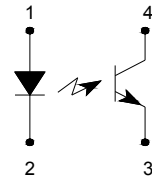

OPB703WZ, OPB704WZ, OPB705WZ, OPB70AWZ, OPB70BWZ, OPB70CWZ, OPB70DWZ

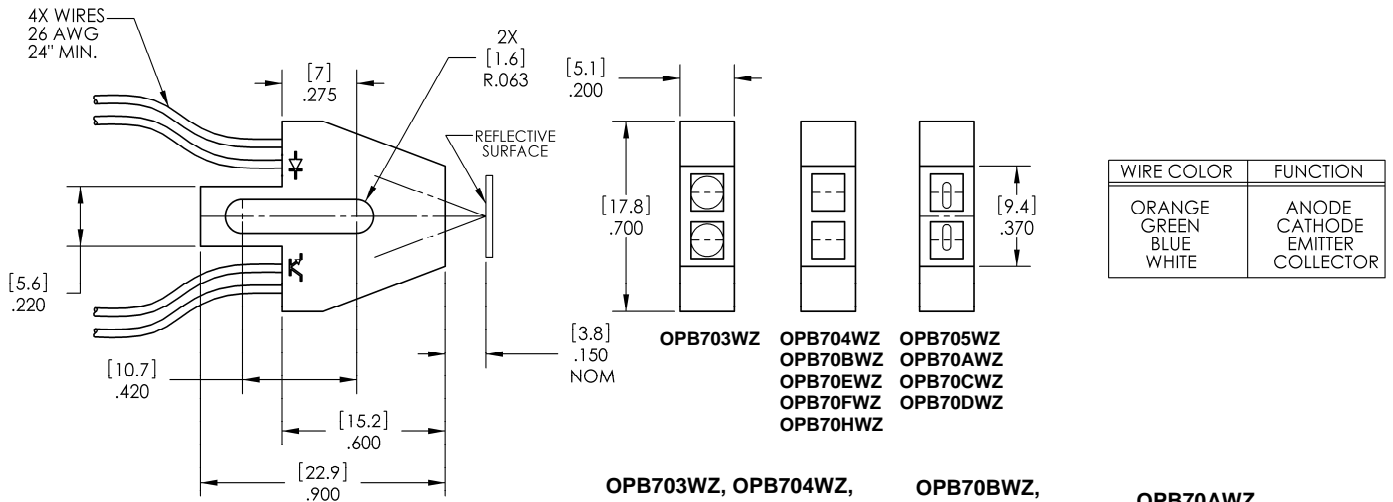

WIRE COLOR	FUNCTION
ORANGE	ANODE
GREEN	CATHODE
BLUE	EMITTER
WHITE	COLLECTOR

DIMENSIONS ARE IN INCHES [MM]
TOLERANCES ARE ± .010 UNLESS OTHERWISE SPECIFIED.

OPB703WZ, OPB704WZ, OPB705WZ, OPB70DWZ OPB70HWZ

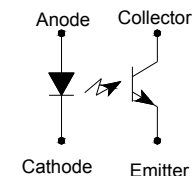

OPB70BWZ, OPB70CWZ OPB70EWZ

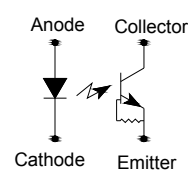

OPB70AWZ

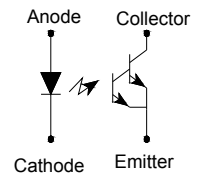

OPTEK reserves the right to make changes at any time in order to improve design and to supply the best product possible.

Reflective Object Sensor
OPB703 through OPB705, OPB703WZ through OPB705WZ,
OPB70AWZ through OPB70HWZ



OPB704G

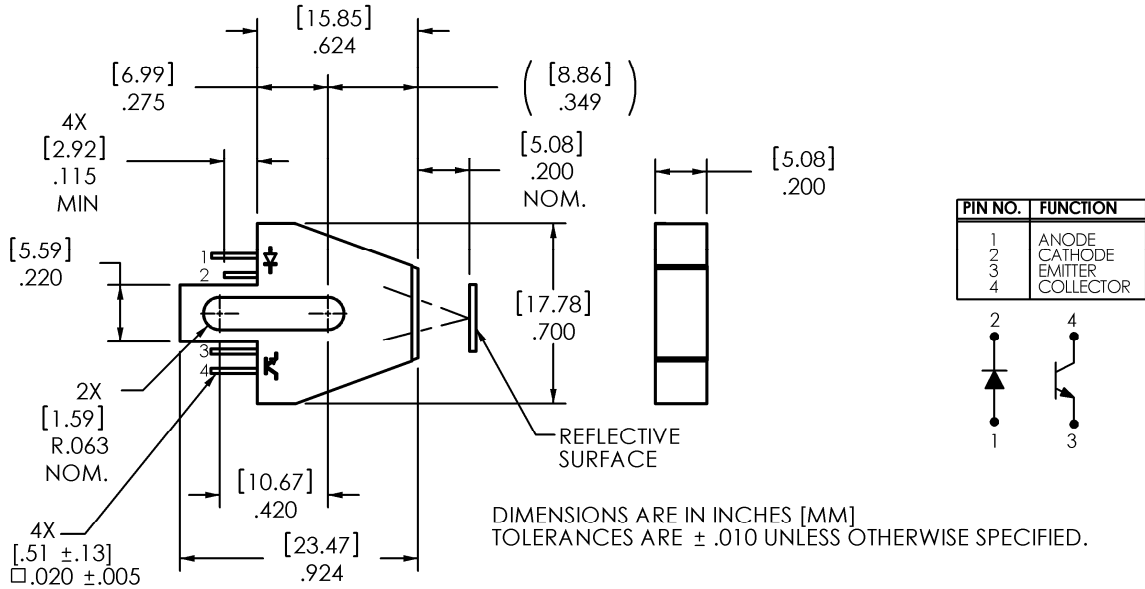

OPB704GWZ

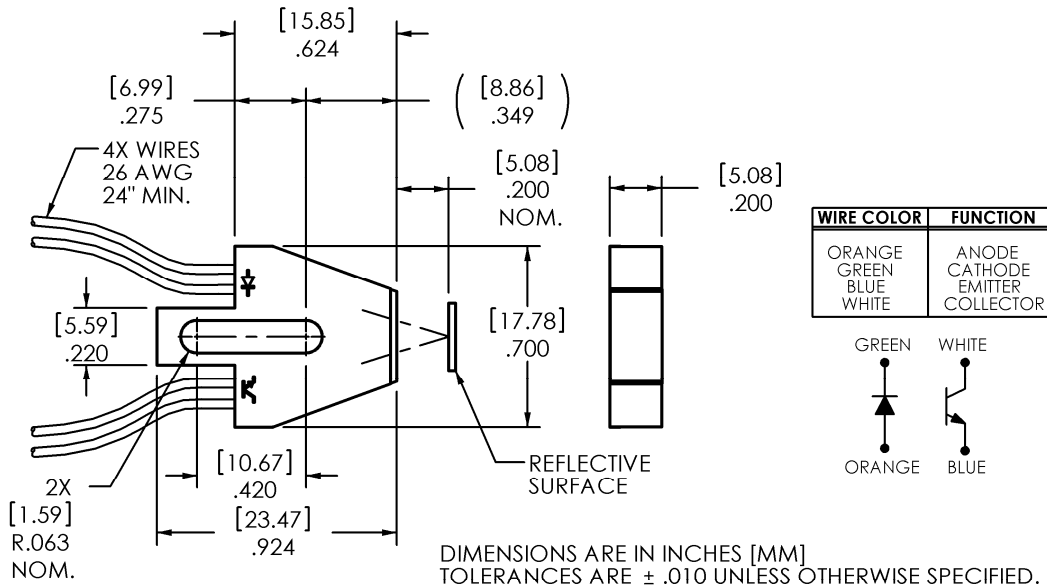

OPTEK reserves the right to make changes at any time in order to improve design and to supply the best product possible.

Reflective Object Sensor

OPB703 through OPB705, OPB703WZ through OPB705WZ,
OPB70AWZ through OPB70HWZ



Absolute Maximum Ratings ($T_A=25^\circ\text{C}$ unless otherwise noted)

Storage Temperature Range	-40°C to +80°C
Lead Soldering Temperature [1/16 inch (1.6 mm) from the case for 5 sec. with soldering iron]	240°C ⁽¹⁾

Input Diode

Forward DC Current	40 mA
Reverse DC Voltage	2 V
Power Dissipation	100 mW ⁽²⁾

Output Photodetector

Collector-Emitter Voltage Phototransistor Photodarlington	30 V 15 V
Emitter-Collector Voltage	5 V
Collector DC Current	25 mA
Power Dissipation	100 mW ⁽²⁾

Electrical Characteristics ($T_A = 25^\circ\text{C}$ unless otherwise noted)

(OPB703, OPB703WZ, OPB704, OPB704WZ, OPB705, OPB705WZ, OPB704G, OPB704GWZ, OPB70HWZ)

SYMBOL	PARAMETER	MIN	TYP	MAX	UNITS	TEST CONDITIONS
--------	-----------	-----	-----	-----	-------	-----------------

Input Diode (See OP265 for additional information — for reference only)

V_F	Forward Voltage	-	-	1.7	V	$I_F = 40\text{mA}$
I_R	Reverse Current	-	-	100	μA	$V_R = 2\text{V}$

Output Phototransistor (See OP505 for additional information — for reference only)

$V_{(BR)CEO}$	Collector-Emitter Breakdown Voltage	30	-	-	V	$I_{CE} = 100\ \mu\text{A}$
$V_{(BR)ECO}$	Emitter-Collector Breakdown Voltage	5	-	-	V	$I_{EC} = 100\ \mu\text{A}$
I_{CEO}	Collector Dark Current	-	-	250	nA	$V_{CE} = 10\text{V}, I_F = 0, E_E = 0$

Coupled

$I_{C(ON)}$	On-State Collector Current OPB70HWZ OPB703, OPB703WZ OPB704, OPB704WZ OPB705, OPB705WZ	0.60 0.30 0.20 0.15	- - - -	3.5 2.5 2.5 1.0	mA	$V_{CE} = 5\text{V}, I_F = 40\text{mA}, d = 0.15''$ ⁽³⁾⁽⁷⁾
	OPB704G, OPB704GWZ	0.50	-	6.0		
I_{CX}	Crosstalk	-	-	20	μA	$V_{CE} = 5\text{V}, I_F = 40\text{mA}$ ⁽⁶⁾
	OPB703, OPB703WZ	-	-	20		
	OPB704, OPB704WZ, OPB70HWZ	-	-	20		
	OPB705, OPB705WZ	-	-	10		

Notes:

- (1) RMA flux is recommended. Duration can be extended to 10 seconds maximum when flow soldering.
- (2) For OPB703, OPB704 and OPB705, derate linearly 1.67 mW/ $^\circ\text{C}$ above 25 $^\circ\text{C}$.
- (3) For OPB703WZ, OPB704WZ, OPB705WZ, OPB70BWZ, OPB704G, OPB704GWZ and OPB70HWZ derate linearly 1.82 mW/ $^\circ\text{C}$ above 25 $^\circ\text{C}$.
- (4) The distance from the assembly face to the reflective surface is d.
- (5) Crosstalk (I_{CX}) is the collector current measured with the indicated current in the input diode and with no reflecting surface.
- (6) Measured using Eastman Kodak neutral white test card with 90% diffuse reflectance as a reflecting surface. Reference: Eastman Kodak, Catalog # E 152 7795.

OPTEK reserves the right to make changes at any time in order to improve design and to supply the best product possible.

Reflective Object Sensor
OPB703 through OPB705, OPB703WZ through OPB705WZ,
OPB70AWZ through OPB70HWZ



Electrical Characteristics ($T_A = 25^\circ\text{C}$ unless otherwise noted)
(OPB70AWZ)

SYMBOL	PARAMETER	MIN	TYP	MAX	UNITS	TEST CONDITIONS
--------	-----------	-----	-----	-----	-------	-----------------

Input Diode (See OP265 for additional information — for reference only)

V_F	Forward Voltage	-	-	1.7	V	$I_F = 40\text{mA}$
I_R	Reverse Current	-	-	100	μA	$V_R = 2\text{V}$

Output PhotoDarlington (See OP535 for additional information — for reference only)

$V_{(BR)CEO}$	Collector-Emitter Breakdown Voltage	15	-	-	V	$I_{CE} = 1.0\text{mA}, E_E = 0$
$V_{(BR)ECO}$	Emitter-Collector Breakdown Voltage	5	-	-	V	$I_{EC} = 100\mu\text{A}, E_E = 0$
I_{CEO}	Collector Dark Current	-	-	250	nA	$V_{CE} = 10\text{V}, I_F = 0, E_E = 0$

Coupled

$I_{C(ON)}$	On-State Collector Current	5.0	-	26.0	mA	$V_{CE} = 5\text{V}, I_F = 40\text{mA}, d = 0.15''^{(2)(5)}$
$V_{(SAT)}$	Saturation Voltage	-	-	1.15	V	$I_C = 400\mu\text{A}, I_F = 40\text{mA}, d = 0.15''^{(2)(5)}$
I_{CX}	Crosstalk	-	-	25	μA	$V_{CE} = 5\text{V}, I_F = 40\text{mA}^{(4)}$

Notes:

- (1) RMA flux is recommended. Duration can be extended to 10 seconds maximum when flow soldering.
- (2) Derate linearly $1.82\text{mW}/^\circ\text{C}$ above 25°C .
- (3) The distance from the assembly face to the reflective surface is d .
- (4) Crosstalk (I_{CX}) is the collector current measured with the indicated current in the input diode and with no reflecting surface.
- (5) Measured using Eastman Kodak neutral white test card with 90% diffuse reflectance as a reflecting surface. Reference: Eastman Kodak, Catalog # E 152 7795.
- (6) All parameters tested using pulse techniques.

OPTEK reserves the right to make changes at any time in order to improve design and to supply the best product possible.

Reflective Object Sensor
OPB703 through OPB705, OPB703WZ through OPB705WZ,
OPB70AWZ through OPB70HWZ



Electrical Characteristics ($T_A = 25^\circ\text{C}$ unless otherwise noted)
(OPB70BWZ)

SYMBOL	PARAMETER	MIN	TYP	MAX	UNITS	TEST CONDITIONS
--------	-----------	-----	-----	-----	-------	-----------------

Input Diode (See OP265 for additional information — for reference only)

V_F	Forward Voltage	-	-	1.7	V	$I_F = 40\text{mA}$
I_R	Reverse Current	-	-	100	μA	$V_R = 2\text{V}$

Output Phototransistor (See OP705 for additional information — for reference only)

$V_{(BR)CEO}$	Collector-Emitter Breakdown Voltage	30	-	-	V	$I_{CE} = 100\ \mu\text{A}$
$V_{(BR)ECO}$	Emitter-Collector Breakdown Voltage	0.4	-	-	V	$I_{EC} = 100\ \mu\text{A}$
I_{CEO}	Collector Dark Current	-	-	100	nA	$V_{CE} = 10\text{V}, I_F = 0, E_E = 0$

Coupled

$I_{C(ON)}$	On-State Collector Current OPB70BWZ	0.50	-	3.0	mA	$V_{CE} = 5\text{V}, I_F = 40\text{mA}, d = 0.15''^{(3)(6)}$
I_{CX}	Crosstalk OPB70BWZ	-	-	5	μA	$V_{CE} = 5\text{V}, I_F = 40\text{mA}^{(5)}$

Notes:

- (1) RMA flux is recommended. Duration can be extended to 10 seconds maximum when flow soldering.
- (2) For OPB703, OPB704 and OPB705, derate linearly $1.67\text{ mW}/^\circ\text{C}$ above 25°C .
- (3) For OPB703WZ, OPB704WZ, OPB705WZ and OPB70BWZ, derate linearly $1.82\text{ mW}/^\circ\text{C}$ above 25°C .
- (4) The distance from the assembly face to the reflective surface is d .
- (5) Crosstalk (I_{CX}) is the collector current measured with the indicated current in the input diode and with no reflecting surface.
- (6) Measured using Eastman Kodak neutral white test card with 90% diffuse reflectance as a reflecting surface. Reference: Eastman Kodak, Catalog # E 152 7795.
- (7) All parameters tested using pulse techniques.

OPTEK reserves the right to make changes at any time in order to improve design and to supply the best product possible.

Reflective Object Sensor
OPB703 through OPB705, OPB703WZ through OPB705WZ,
OPB70AWZ through OPB70HWZ



Electrical Characteristics ($T_A = 25^\circ \text{C}$ unless otherwise noted)
(OPB70CWZ and OPB70EWZ)

SYMBOL	PARAMETER	MIN	TYP	MAX	UNITS	TEST CONDITIONS
--------	-----------	-----	-----	-----	-------	-----------------

Input Diode (See OVLAS6CB8 for additional information — for reference only)

V_F	Forward Voltage	-	-	2.6	V	$I_F = 40\text{mA}$
I_R	Reverse Current	-	-	100	μA	$V_R = 2 \text{ V}$

Output Phototransistor (See OP505 for additional information — for reference only)

$V_{(BR)CEO}$	Collector-Emitter Breakdown Voltage	30	-	-	V	$I_{CE} = 100\mu\text{A}, I_F = 0, E_E = 0$
$V_{(BR)ECO}$	Emitter-Collector Breakdown Voltage	0.4	-	-	V	$I_{EC} = 100\mu\text{A}, I_F = 0, E_E = 0$
I_{CEO}	Collector Dark Current	-	-	100	nA	$V_{CE} = 10 \text{ V}, I_F = 0, E_E = 0$

Coupled

$I_{C(ON)}$	On-State Collector Current	OPB70CWZ	.10	-	1.0	mA	$V_{CE} = 5 \text{ V}, I_F = 40\text{mA}, d = 0.15''^{(2)(5)}$
		OPB70EWZ	.25	-	2.5		
$V_{(SAT)}$	Saturation Voltage	-	-	0.4	V	$I_C = 100 \mu\text{A}, I_F = 40\text{mA}, d = 0.15''^{(2)(5)}$	
I_{CX}	Crosstalk	-	-	2	μA	$V_{CE} = 5 \text{ V}, I_F = 40\text{mA}^{(4)}$	

Notes:

- (1) RMA flux is recommended. Duration can be extended to 10 seconds maximum when flow soldering.
- (2) For OPB703WZ, OPB704WZ, OPB705WZ and OPB70BWZ, derate linearly $1.82 \text{ mW}/^\circ \text{C}$ above 25°C .
- (3) The distance from the assembly face to the reflective surface is d .
- (4) Lower curve is based on a calculated worst-case condition, rather than the conventional -2Ω limit.
- (5) Crosstalk (I_{CX}) is the collector current measured with the indicated current in the input diode and with no reflecting surface.
- (6) Measured using Eastman Kodak neutral white test card with 90% diffuse reflectance as a reflecting surface. Reference: Eastman Kodak, Catalog # E 152 7795.
- (7) All parameters tested using pulse techniques.

OPTEK reserves the right to make changes at any time in order to improve design and to supply the best product possible.

Reflective Object Sensor
OPB703 through OPB705, OPB703WZ through OPB705WZ,
OPB70AWZ through OPB70HWZ



Electrical Characteristics ($T_A = 25^\circ\text{C}$ unless otherwise noted)
(OPB70DWZ and OPB70FWZ)

SYMBOL	PARAMETER	MIN	TYP	MAX	UNITS	TEST CONDITIONS
--------	-----------	-----	-----	-----	-------	-----------------

Input Diode (See OVLAS6CB8 for additional information — for reference only)

V_F	Forward Voltage	-	-	2.6	V	$I_F = 40\text{mA}$
I_R	Reverse Current	-	-	100	μA	$V_R = 2\text{V}$

Output Phototransistor (See OP505 for additional information — for reference only)

$V_{(BR)CEO}$	Collector-Emitter Breakdown Voltage	30	-	-	V	$I_{CE} = 100\mu\text{A}, I_F = 0, E_E = 0$
$V_{(BR)ECO}$	Emitter-Collector Breakdown Voltage	5.0	-	-	V	$I_{EC} = 100\mu\text{A}, I_F = 0, E_E = 0$
I_{CEO}	Collector Dark Current	-	-	250	nA	$V_{CE} = 10\text{V}, I_F = 0, E_E = 0$

Coupled

$I_{C(ON)}$	On-State Collector Current	OPB70DWZ	.10	-	1.5	mA	$V_{CE} = 5\text{V}, I_F = 40\text{mA}, d = 0.15''^{(2)(5)}$
		OPB70FWZ	.25	-	3.5		
$V_{(SAT)}$	Saturation Voltage	-	-	0.4	V	$I_{C(ON)} = 100\mu\text{A}, I_F = 40\text{mA}, d = 0.15''^{(2)(5)}$	
I_{CX}	Crosstalk	-	-	5.0	μA	$V_{CE} = 5\text{V}, I_F = 40\text{mA}^{(4)}$	

Notes:

- (1) RMA flux is recommended. Duration can be extended to 10 seconds maximum when flow soldering.
- (2) For OPB703WZ, OPB704WZ, OPB705WZ and OPB70BWZ, derate linearly 1.82 mW/ $^\circ\text{C}$ above 25°C .
- (3) The distance from the assembly face to the reflective surface is d.
- (4) Crosstalk (I_{CX}) is the collector current measured with the indicated current in the input diode and with no reflecting surface.
- (5) Measured using Eastman Kodak neutral white test card with 90% diffuse reflectance as a reflecting surface. Reference: Eastman Kodak, Catalog # E 152 7795.
- (6) All parameters tested using pulse techniques.

OPTEK reserves the right to make changes at any time in order to improve design and to supply the best product possible.

OPB703—Output Distance

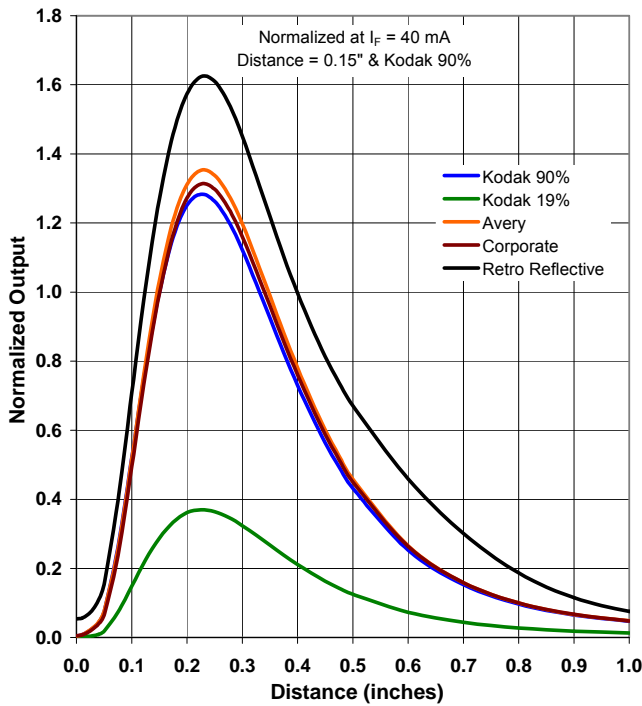

OPB704, OPB70B, OPB70H—Output Distance

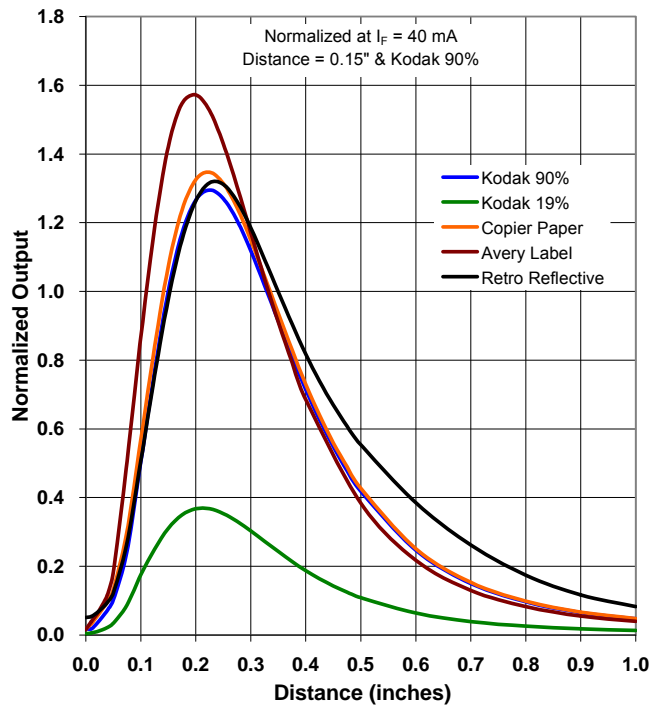

OPB705, OPB70A, OPB70C, OPB70D—Output Distance

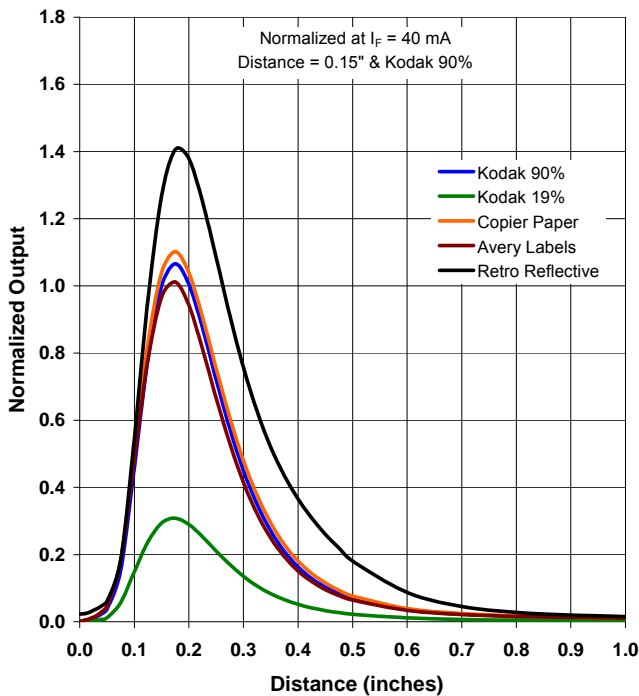

LED Forward Voltage vs Forward Current vs Temp

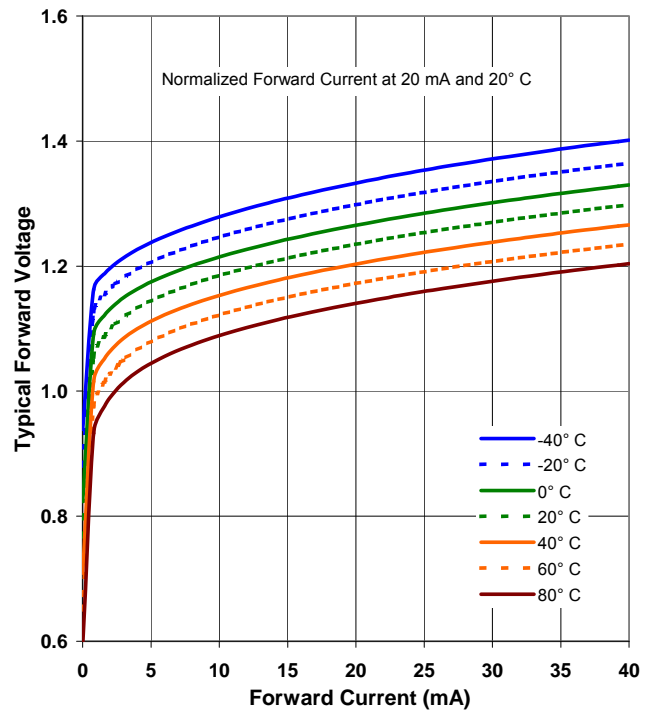

OPTEK reserves the right to make changes at any time in order to improve design and to supply the best product possible.

Reflective Object Sensor
OPB703 through OPB705, OPB703WZ through OPB705WZ,
OPB70AWZ through OPB70HWZ

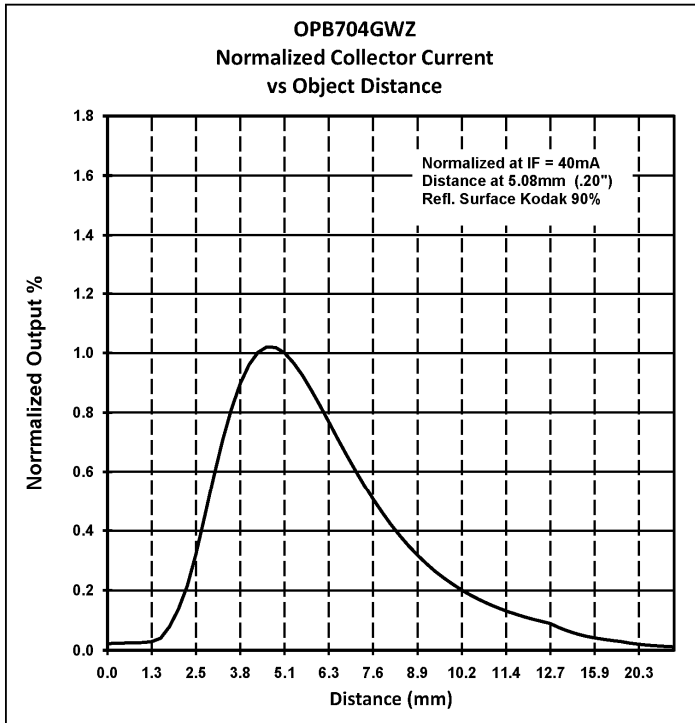

OPTEK reserves the right to make changes at any time in order to improve design and to supply the best product possible.