

Silicon Super Fast Recovery Diode

$V_{RRM} = 600\text{ V} - 1200\text{ V}$

$I_{F(AV)} = 300\text{ A}$

Features

- High Surge Capability
- Types from 600 V to 1200 V V_{RRM}
- Isolation Type Package
- Electrically Isolated Base Plate
- Not ESD Sensitive

Heavy Three Tower Package

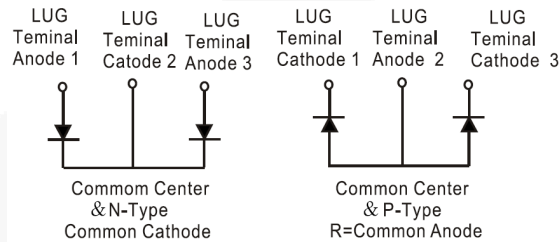

Maximum ratings, at $T_j = 25\text{ }^\circ\text{C}$, unless otherwise specified ("R" devices have leads reversed)

Parameter	Symbol	Conditions	MURTA30060(R)	MURTA300120(R)	Unit
Repetitive peak reverse voltage	V_{RRM}		600	1200	V
RMS reverse voltage	V_{RMS}		424	---	V
DC blocking voltage	V_{DC}		600	1200	V
Operating temperature	T_j		-55 to 150	-55 to 150	$^\circ\text{C}$
Storage temperature	T_{stg}		-55 to 150	-55 to 150	$^\circ\text{C}$

Electrical characteristics, at $T_j = 25\text{ }^\circ\text{C}$, unless otherwise specified

Parameter	Symbol	Conditions	MURTA30060(R)	MURTA300120(R)	Unit
Average forward current (per pkg)	$I_{F(AV)}$	$T_C = 100\text{ }^\circ\text{C}$	300	300	A
Peak forward surge current (per leg)	I_{FSM}	$t_p = 8.3\text{ ms}$, half sine	2750	2750	A
Maximum instantaneous forward voltage (per leg)	V_F	$I_{FM} = 150\text{ A}$, $T_j = 25\text{ }^\circ\text{C}$	1.7	2.6	V
Maximum instantaneous reverse current at rated DC blocking voltage (per leg)	I_R	$T_j = 25\text{ }^\circ\text{C}$	25	25	μA
		$T_j = 125\text{ }^\circ\text{C}$	5	5	mA
Maximum reverse recovery time (per leg)	T_{rr}	$I_F = 0.5\text{ A}$, $I_R = 1.0\text{ A}$, $I_{RR} = 0.25\text{ A}$	150	150	ns

Thermal characteristics

Maximum thermal resistance, junction - case (per leg)	$R_{\theta JC}$		0.40	0.40	$^\circ\text{C/W}$
---	-----------------	--	------	------	--------------------

MURTA30060(R) Figures:

Figure .1- Typical Forward Characteristics

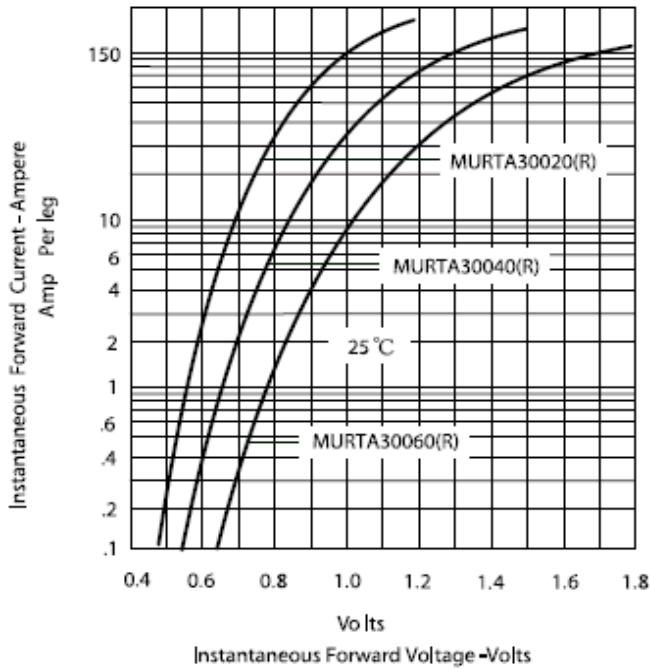

Figure .2- Forward Derating Curve

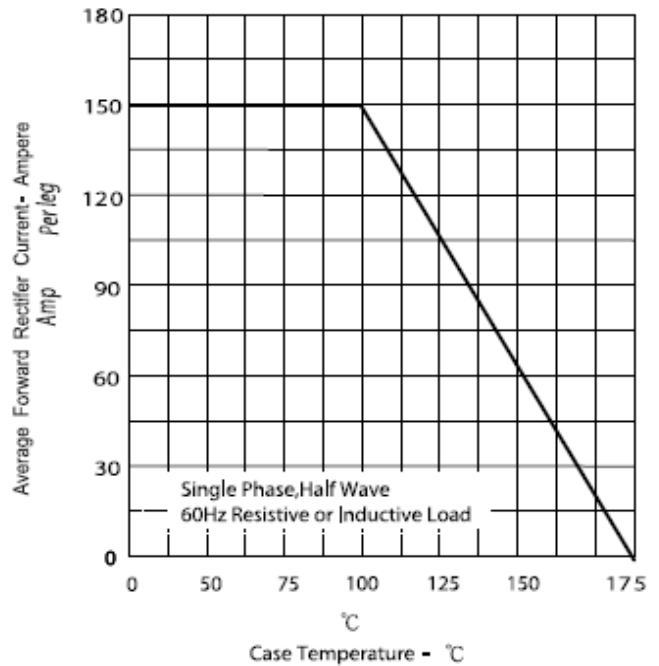

Figure .3- Peak Forward Surge Current

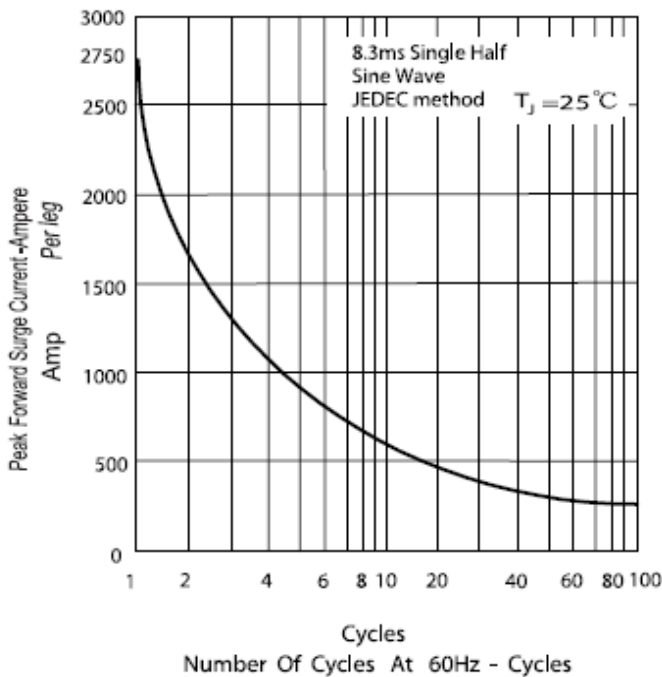
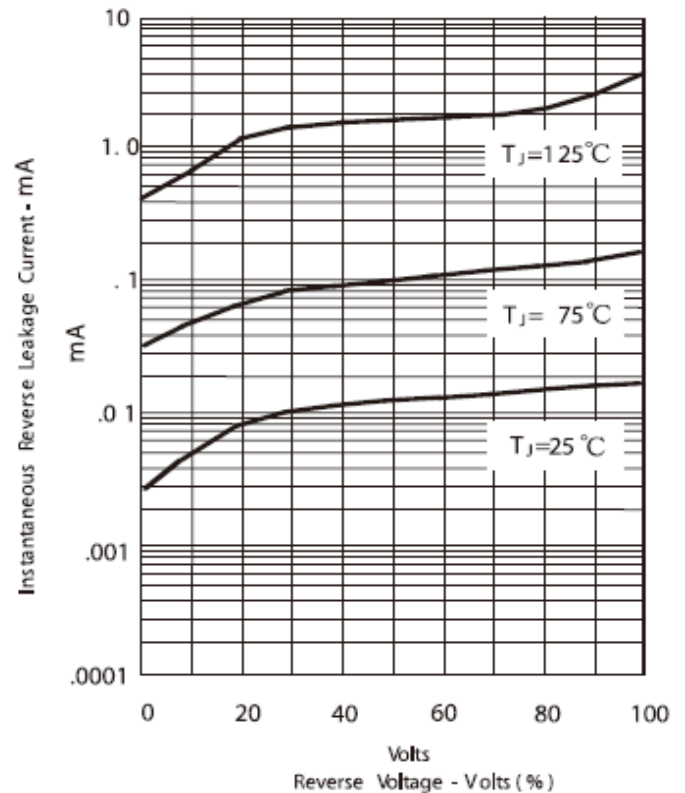

Figure .4- Typical Reverse Characteristics



MURTA300120(R) Figures:

Figure .1- Typical Forward Characteristics

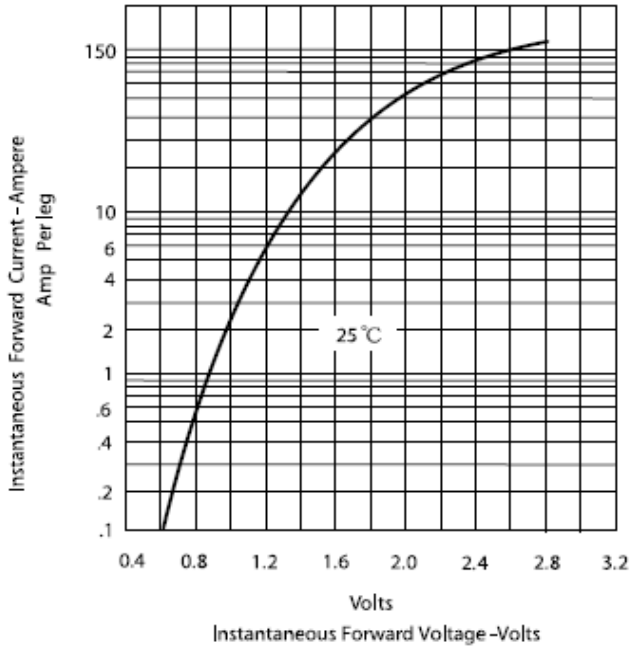

Figure .2- Forward Derating Curve

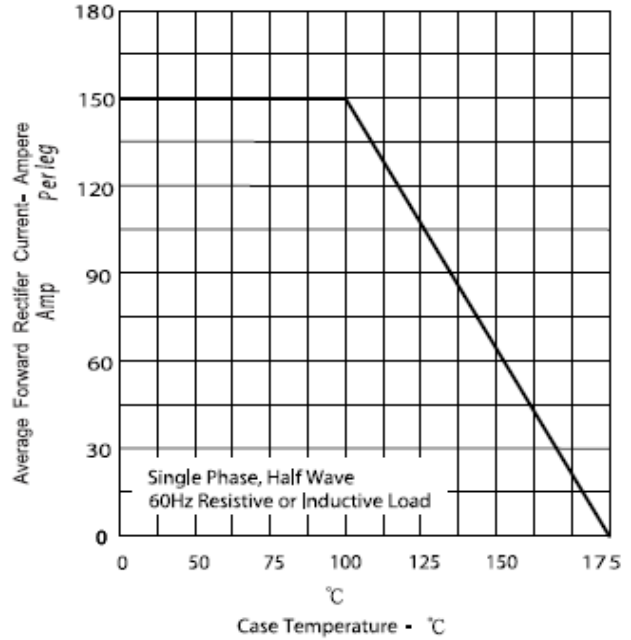

Figure .3- Peak Forward Surge Current

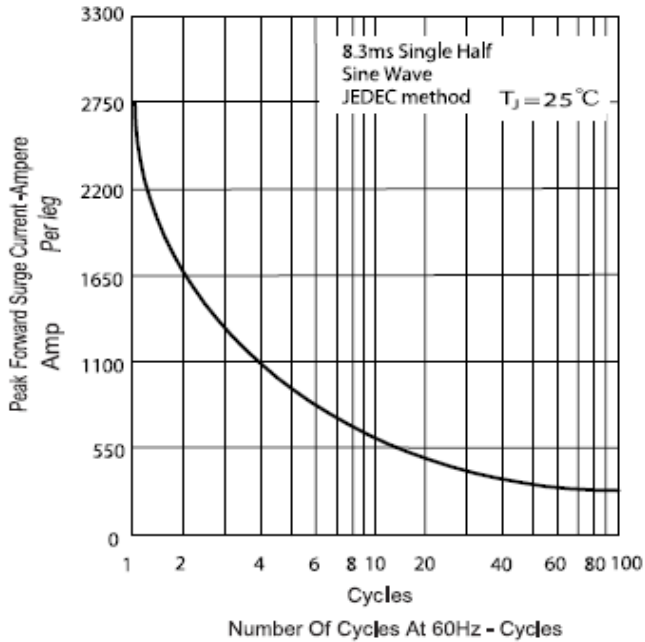
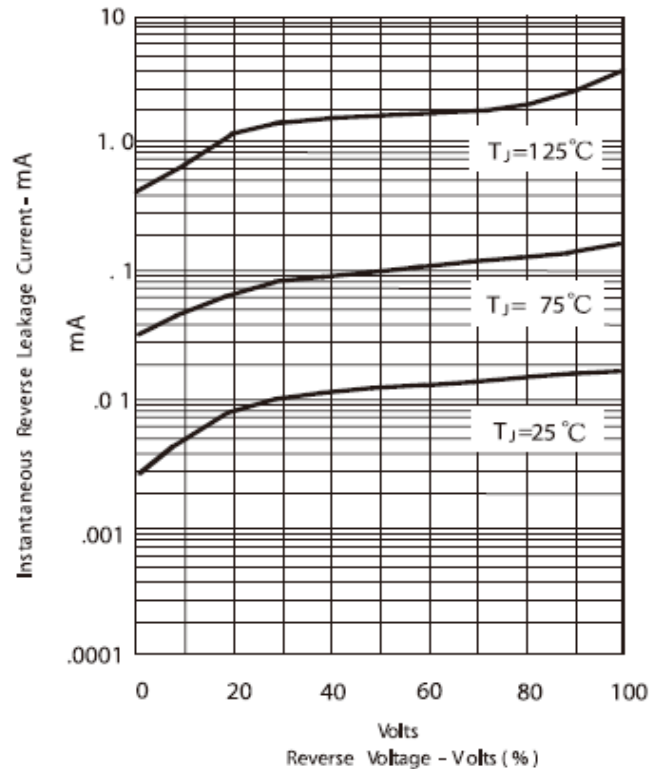
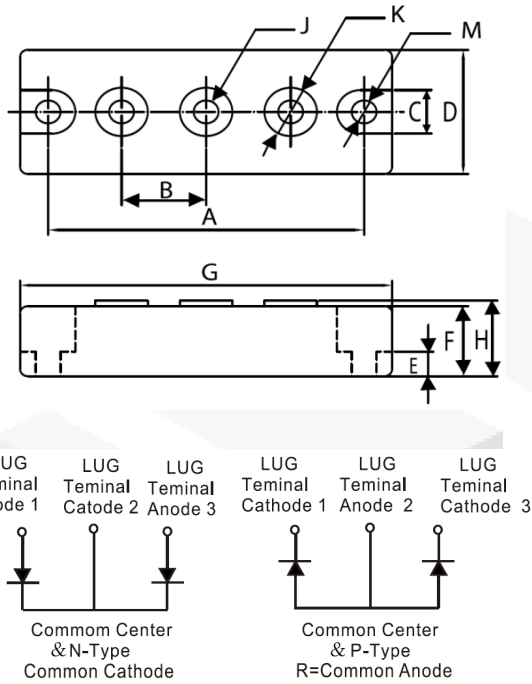

Figure .4-Typical Reverse Characteristics



Package dimensions and terminal configuration

Product is marked with part number and terminal configuration.



DIMENSIONS				
DIM	Inches		Millimeters	
	Min	Max	Min	Max
A	3.150	NOM	80.01	NOM
B	.872	.892	22.15	22.65
C	.465	.479	11.82	12.18
D	1.337	1.356	33.95	34.45
E	.230	.234	5.84	6.16
F	.725	REF	18.42	REF
G	3.668	3.768	93.17	95.71
H	—	.791	—	20.10
J	1/4-20 UNC FULL			
K	.509	.538	12.92	13.68
M	.238	.258	6.05	6.55