

QBVS050A0B Barracuda* Series; DC-DC Converter Power Modules

52-60Vdc Input; 12.0Vdc, 50.0A, 600W Output

RoHS Compliant



Applications

- Distributed power architectures
- Intermediate bus voltage applications
- Servers and storage applications

Options

- Negative Remote On/Off logic (1=option code, factory preferred)
- Auto-restart after fault shutdown (4=option code, factory preferred)
- Pin Trim

Description

The QBVS050A0B Barracuda series of dc-dc converters are a new generation of fully regulated DC/DC power modules designed to support 12.0Vdc intermediate bus applications where multiple low voltages are subsequently generated using point of load (POL) converters, as well as other application requiring a tightly regulated output voltage. The QBVS050A0B series operate from an input voltage range of 52 to 60Vdc and provide up to 50.0A output current at output voltages of 12.0V_{dc} in an industry standard, DOSA compliant quarter brick. The converter incorporates digital control, synchronous rectification technology, a fully regulated control topology, and innovative packaging techniques to achieve efficiency exceeding 97% at 12.0V output. This leads to lower power dissipations such that for many applications a heat sink is not required. Standard features include on/off control, output overcurrent and over voltage protection, over temperature protection, input under and over voltage lockout.

The output is fully isolated from the input, allowing versatile polarity configurations and grounding connections. Built-in filtering for both input and output minimizes the need for external filtering.

Features

- Compliant to RoHS II EU "Directive 2011/65/EU" (-Z versions)
- Compliant to REACH Directive (EC) No 1907/2006
- High and flat efficiency profile >96.5% at 12.0V_{dc}, 50% load to 100% output
- Input voltage range: 52-60V_{dc}
- Delivers up to 50.0A_{dc} output current
- Fully very tightly regulated output voltage
- Low output ripple and noise
- Industry standard, DOSA Compliant Quarter Brick:
 - 58.4 mm x 36.8 mm x 12.7 mm
 - (2.30 in x 1.45 in x 0.50 in)
- Base plate (-H=option code, must be ordered)
- Constant switching frequency
- Positive Remote On/Off logic
- Output over current/voltage protection
- Over temperature protection
- Wide operating temperature range
 - -5°C to 85°C, continuous
 - -20°C to 90°C, short term, ≤ 96hrs/year
- UL# 60950-1, 2nd Ed. Recognized, CSA† C22.2 No. 60950-1-07 Certified, and VDE‡ (EN60950-1, 2nd Ed.) Licensed
- CE mark to 2006/96/EC directive§
- 750Vdc Functional Isolation
- ISO** 9001 and ISO14001 certified manufacturing facilities

* Trademark of General Electric Company

UL is a registered trademark of Underwriters Laboratories, Inc.

† CSA is a registered trademark of Canadian Standards Association.

‡ VDE is a trademark of Verband Deutscher Elektrotechniker e.V.

§ This product is intended for integration into end-user equipment. All of the required procedures of end-use equipment should be followed.

** ISO is a registered trademark of the International Organization of Standards.

QBVS050A0B Barracuda Series; DC-DC Converter Power Modules

52-60Vdc Input; 12.0Vdc, 50.0A, 600W Output

Absolute Maximum Ratings

Stresses in excess of the absolute maximum ratings can cause permanent damage to the device. These are absolute stress ratings only, functional operation of the device is not implied at these or any other conditions in excess of those given in the operations sections of the Data Sheet. Exposure to absolute maximum ratings for extended periods can adversely affect device reliability.

Parameter	Device	Symbol	Min	Max	Unit
Input Voltage*					
Continuous		V_{IN}	-0.3	60	V_{dc}
Non- operating continuous		V_{IN}		75	V_{dc}
Operating Ambient Temperature (See Thermal Considerations section)	All	T_A	-20	85	$^{\circ}C$
Storage Temperature	All	T_{stg}	-55	125	$^{\circ}C$
I/O Isolation Voltage (100% factory Hi-Pot tested)	All	—	—	750	V_{dc}

* Input over voltage protection will shutdown the output voltage when the input voltage exceeds threshold level.

Electrical Specifications

Unless otherwise indicated, specifications apply over all operating input voltage, resistive load, and temperature conditions.

Parameter	Device	Symbol	Min	Typ	Max	Unit
Operating Input Voltage		V_{IN}	52	54	60	V_{dc}
Maximum Input Current ($V_{IN}=45V$, $I_O=I_{O,max}$)		$I_{IN,max}$	-	-	13	A_{dc}
Input No Load Current ($V_{IN} = V_{IN,nom}$, $I_O = 0$, module enabled)	All	$I_{IN,No\ load}$		175		mA
Input Stand-by Current ($V_{IN} = V_{IN,nom}$, module disabled)	All	$I_{IN,stand-by}$			20	mA
External Input Capacitance	All		120	600	-	μF
Inrush Transient	All	I^2t	-	-	1	A^2s
Input Reflected Ripple Current, peak-to-peak (5Hz to 20MHz, 12 μH source impedance; $V_{IN}= 48V$, $I_O= I_{O,max}$; see Figure 9)	All		-	40	-	mA_{p-p}
Input Terminal Ripple Current (Measured at module input pin with maximum specified input capacitance and < 500uH inductance between voltage source and input capacitance) 5Hz to 20MHz, $V_{IN}= 52V$ to 60V, $I_O= I_{O,max}$	All		-	-	800	mA_{rms}
Input Ripple Rejection (120Hz)	All		-	25	-	dB

CAUTION: This power module is not internally fused. An input line fuse must always be used.

This power module can be used in a wide variety of applications, ranging from simple standalone operation to an integrated part of sophisticated power architecture. To preserve maximum flexibility, internal fusing is not included, however, to achieve maximum safety and system protection, always use an input line fuse. The safety agencies require a fast-acting fuse with a maximum rating of 25A in the ungrounded input lead of the power supply (see Safety Considerations section). Based on the information provided in this Data Sheet on inrush energy and maximum dc input current, the same type of fuse with a lower rating can be used. Refer to the fuse manufacturer's Data Sheet for further information.

QBVS050A0B Barracuda Series; DC-DC Converter Power Modules

52-60Vdc Input; 12.0Vdc, 50.0A, 600W Output

Electrical Specifications (continued)

Parameter	Device	Symbol	Min	Typ	Max	Unit
Output Voltage Set-point ($V_{IN}=V_{IN,nom}$, $I_O=25.0A$, $T_A=25^\circ C$)	All	$V_{O,set}$	11.95	12.00	12.05	V _{dc}
Output Voltage (Over all operating input voltage (52V to 60V), resistive load, and temperature conditions until end of life)	All	V_O	11.70	—	12.30	V _{dc}
Output Regulation						
Line ($V_{IN}=V_{IN,min}$ to $V_{IN,max}$)	All		—	0.2	—	% $V_{O,set}$
Load ($I_O=I_{O,min}$ to $I_{O,max}$)	All		—	0.2	—	% $V_{O,set}$
Temperature ($T_A = -20^\circ C$ to $+85^\circ C$)	All		—	2	—	% $V_{O,set}$
Output Ripple and Noise on nominal output ($V_{IN}=V_{IN,nom}$ and $I_O=I_{O,min}$ to $I_{O,max}$)						
RMS (5Hz to 20MHz bandwidth)	All		—	70	—	mV _{rms}
Peak-to-Peak (5Hz to 20MHz bandwidth) 750uF	All		—	150	—	mV _{pk-pk}
External Output Capacitance	All	$C_{O,max}$	0	—	4,500	μF
Output Current	All	I_O	0	—	50	A _{dc}
Output Current Limit Inception	All	$I_{O,lim}$	55	—	65	A _{dc}
Output Power	All	P_O	0	—	600	W
Efficiency $V_{IN}=V_{IN,nom}$, $T_A=25^\circ C$ $I_O=100\% I_{O,max}$, $V_O=V_{O,set}$	All	η		97.1		%
$I_O=50\% I_{O,max}$ to $100\% I_{O,max}$, $V_O=V_{O,set}$	All	η		96.5		%
Switching Frequency (Primary FETs)		f_{sw}		150		kHz
Dynamic Load Response $di/dt=1A/10\mu s$; $V_{in}=V_{in,nom}$; $T_A=25^\circ C$; (Tested with a 1.0μF ceramic, and 750μF capacitor and across the load.)						
Load Change from $I_O = 50\%$ to 75% of $I_{O,max}$: Peak Deviation	All	V_{pk}	—	350	—	mV _{pk}
Settling Time ($V_O < 10\%$ peak deviation)		t_s	—	700	—	μs
Load Change from $I_O = 75\%$ to 50% of $I_{O,max}$: Peak Deviation	All	V_{pk}	—	350	—	mV _{pk}
Settling Time ($V_O < 10\%$ peak deviation)		t_s	—	700	—	μs

Isolation Specifications

Parameter	Symbol	Min	Typ	Max	Unit
Isolation Capacitance	C_{iso}	—	0.01	—	μF
Isolation Resistance	R_{iso}	10	—	—	MΩ

General Specifications

Parameter	Symbol	Device	Typ	Unit
Calculated Reliability Based upon Telcordia SR-332 Issue 2: Method I, Case 3, ($I_O=80\% I_{O,max}$, $T_A=40^\circ C$, Airflow = 200 LFM), 90% confidence	MTBF	All	2,615,767	Hours
	FIT	All	382.3	10 ⁹ /Hours
Weight - with Base plate option			73.6 (2.60)	g (oz.)

QBVS050A0B Barracuda Series; DC-DC Converter Power Modules

52-60Vdc Input; 12.0Vdc, 50.0A, 600W Output

Feature Specifications

Unless otherwise indicated, specifications apply over all operating input voltage, resistive load, and temperature conditions. See Feature Descriptions for additional information.

Parameter	Device	Symbol	Min	Typ	Max	Unit
Remote On/Off Signal Interface ($V_{IN}=V_{IN, min}$ to $V_{IN, max}$, Signal referenced to V_{IN} -terminal) Negative Logic: device code suffix "1" Logic Low = module On, Logic High = module Off Positive Logic: No device code suffix required Logic Low = module Off, Logic High = module On Logic Low Specification On/Off Thresholds:						
Remote On/Off Current – Logic Low ($V_{in} = 60V$)	All	$I_{on/off}$	—	—	200	μA
Logic Low Voltage	All	$V_{on/off}$	-0.3	—	0.8	V_{dc}
Logic High Voltage – (Typ = Open Collector)	All	$V_{on/off}$	2.4	—	14.5	V_{dc}
Logic High maximum allowable leakage current ($V_{on/off} = 2.4V$)	All	$I_{on/off}$	—	—	130	μA
Maximum voltage allowed on On/Off pin	All	$V_{on/off}$	—	—	14.5	V_{dc}
Turn-On Delay and Rise Times ($I_o=I_{o, max}$) T_{delay} =Time until $V_o = 10\%$ of $V_{o, set}$ from either application of V_{in} with Remote On/Off set to On (Enable with V_{in}); or operation of Remote On/Off from Off to On with V_{in} already applied for at least 30 milli-seconds (Enable with on/off).	All	$T_{delay, Enable with Vin}$	—	—	30	ms
	All	$T_{delay, Enable with on/off}$	—	—	5	ms
T_{rise} =Time for V_o to rise from 10% to 90% of $V_{o, set}$, For $C_o > 5000\mu F$, I_o must be $< 50\%$ $I_{o, max}$ during T_{rise} .	All	T_{rise}	—	5	—	ms
Output Overvoltage Protection	All	V_{Olimit}	13.0	—	16.0	V_{dc}
Overtemperature Protection (See Feature Descriptions)	All	T_{ref}	—	130	—	$^{\circ}C$
Input Undervoltage Lockout						
Turn-on Threshold			50	51	52	V_{dc}
Turn-off Threshold			47	48	49	V_{dc}
Hysteresis			2	3		V_{dc}
Input Overvoltage Lockout						
Turn-off Threshold			—	64	—	V_{dc}
Turn-on Threshold			60	61	—	V_{dc}

QBVS050A0B Barracuda Series; DC-DC Converter Power Modules

52-60Vdc Input; 12.0Vdc, 50.0A, 600W Output

Characteristic Curves, 12.0V_{dc} Output

The following figures provide typical characteristics for the QBVS050A0B (12.0V, 50A) at 25°C. The figures are identical for either positive or negative Remote On/Off logic.

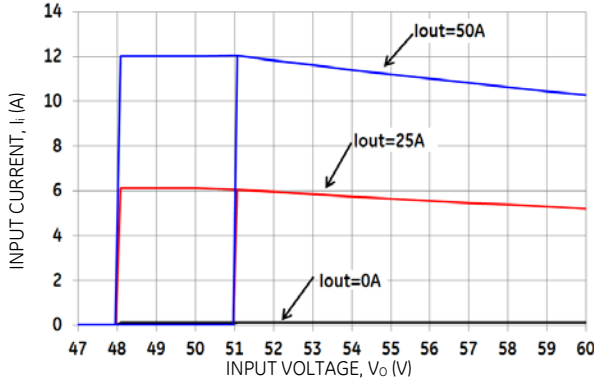

Figure 1. Typical Input Characteristic.

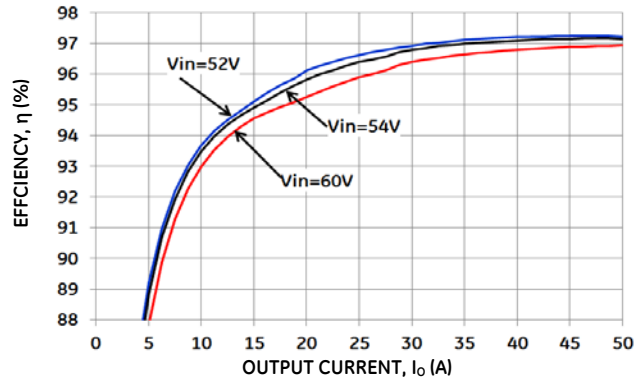

Figure 2. Typical Converter Efficiency vs. Output Current.

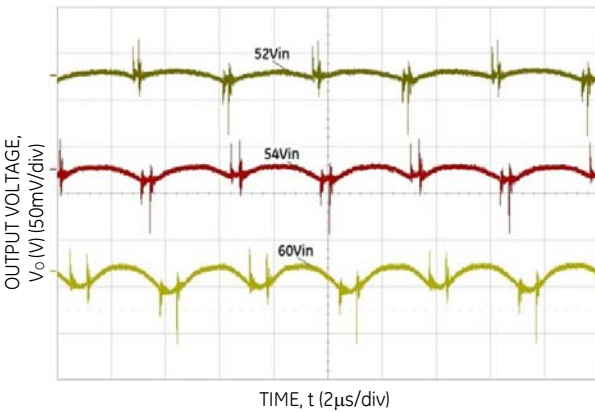

Figure 3. Typical Output Ripple and Noise, $I_o = I_{o,max}$, $C_o=750\mu F$.

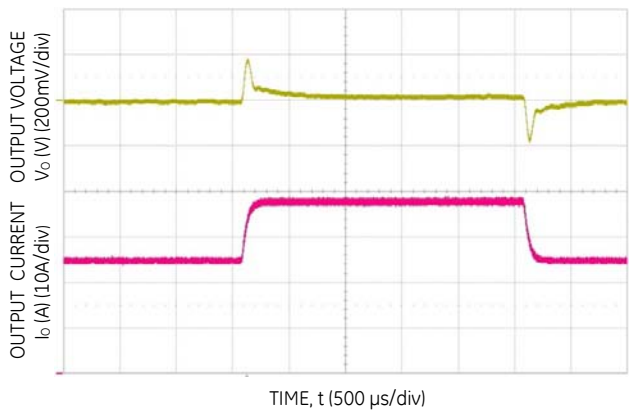

Figure 4. Typical Transient Response to 0.1A/ μ s Step Change in Load from 50% to 75% to 50% of Full Load, $C_o=750\mu F$ and 48 V_{dc} Input.

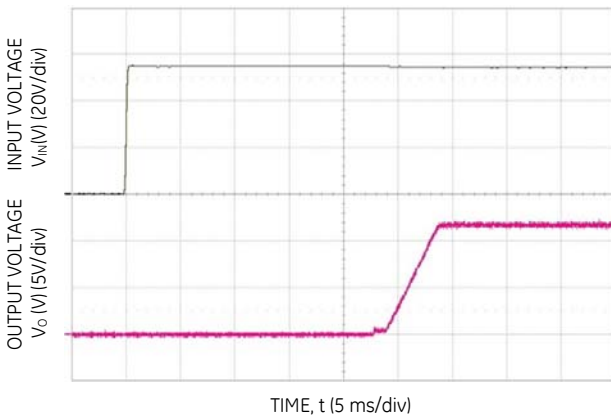

Figure 5. Typical Start-Up Using V_{in} with Remote On/Off enabled, negative logic version shown, $I_o = I_{o,max}$.

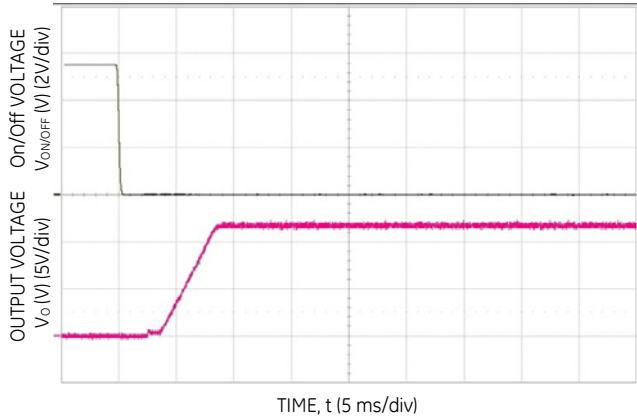

Figure 6. Typical Start-Up Using Remote On/Off with V_{in} applied, negative logic version shown $I_o = I_{o,max}$.

QBVS050A0B Barracuda Series; DC-DC Converter Power Modules
 52-60Vdc Input; 12.0Vdc, 50.0A, 600W Output

Characteristic Curves, 12.0V_{dc} Output (continued)

The following figures provide typical characteristics for the QBVS050A0B (12.0V, 60A) at 25°C. The figures are identical for either positive or negative Remote On/Off logic.

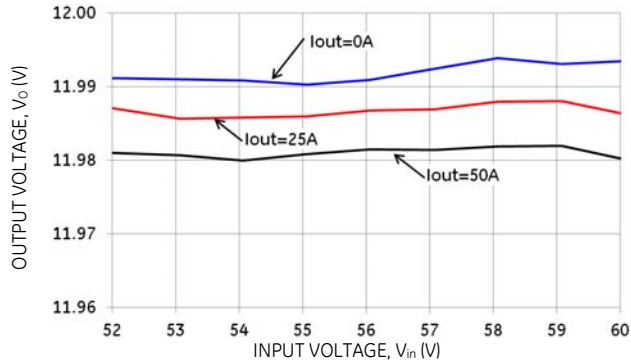

Figure 7. Typical Output Voltage Regulation vs. Input Voltage.

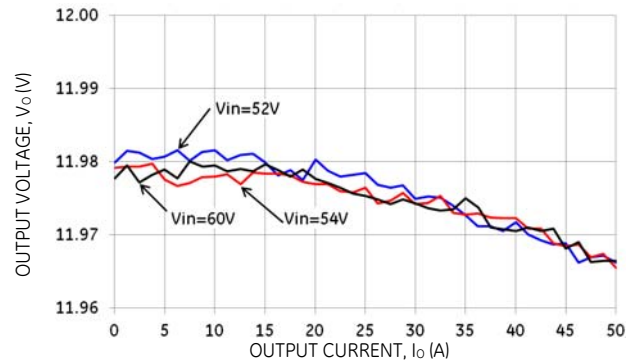
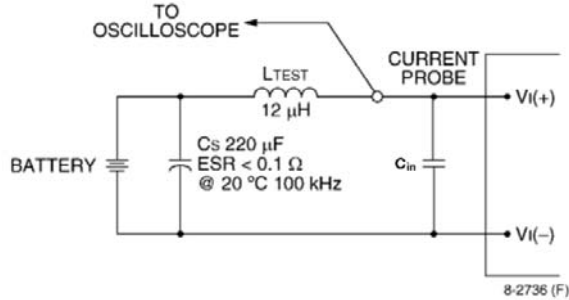

Figure 8. Typical Output Voltage Regulation vs. Output Current.

QBVS050A0B Barracuda Series; DC-DC Converter Power Modules

52-60Vdc Input; 12.0Vdc, 50.0A, 600W Output

Test Configurations



Note: Measure input reflected-ripple current with a simulated source inductance (LTEST) of 12 μH. Capacitor CS offsets possible battery impedance. Measure current as shown above.

Figure 9. Input Reflected Ripple Current Test Setup.

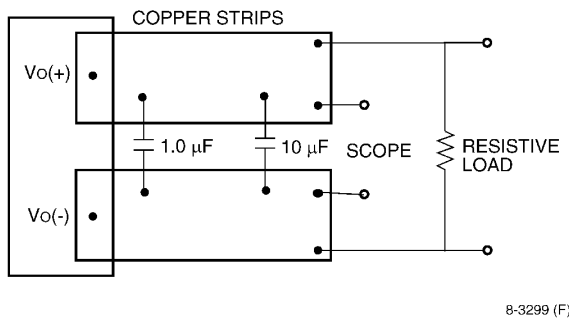

Note: Use a 1.0 μF ceramic capacitor and a 10 μF aluminum or tantalum capacitor. Scope measurement should be made using a BNC socket. Position the load between 51 mm and 76 mm (2 in. and 3 in.) from the module.

Figure 10. Output Ripple and Noise Test Setup.

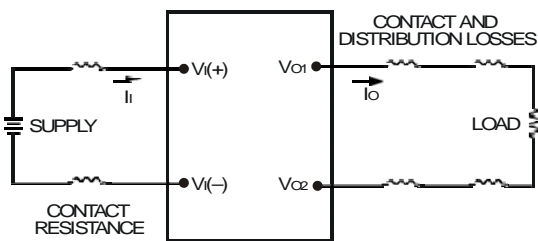

Note: All measurements are taken at the module terminals. When socketing, place Kelvin connections at module terminals to avoid measurement errors due to socket contact resistance.

$$\eta = \left(\frac{[V_{O(+)} - V_{O(-)}]I_{O}}{[V_{I(+)} - V_{I(-)}]I_{I}} \right) \times 100 \%$$

Figure 11. Output Voltage and Efficiency Test Setup.

Design Considerations

Input Source Impedance

The power module should be connected to a low ac-impedance source. Highly inductive source impedance can affect the stability of the power module. For the test configuration in Figure 9, a 680μF electrolytic capacitor, Cin, (ESR<0.7Ω at 100kHz), mounted close to the power module helps ensure the stability of the unit.

Safety Considerations

For safety-agency approval of the system in which the power module is used, the power module must be installed in compliance with the spacing and separation requirements of the end-use safety agency standard, i.e., UL60950-1 2nd Ed., CSA C22.2 No. 60950-1 2nd Ed., and VDE0805-1 EN60950-1 2nd Ed.

If the input source is non-SELV (ELV or a hazardous voltage greater than 60 Vdc and less than or equal to 75Vdc), for the module's output to be considered as meeting the requirements for safety extra-low voltage (SELV), all of the following must be true:

- The input source is to be provided with reinforced insulation from any other hazardous voltages, including the ac mains.
- One VIN pin and one VOUT pin are to be grounded, or both the input and output pins are to be kept floating.
- The input pins of the module are not operator accessible.
- Another SELV reliability test is conducted on the whole system (combination of supply source and subject module), as required by the safety agencies, to verify that under a single fault, hazardous voltages do not appear at the module's output.

Note: Do not ground either of the input pins of the module without grounding one of the output pins. This may allow a non-SELV voltage to appear between the output pins and ground.

The power module has safety extra-low voltage (SELV) outputs when all inputs are SELV.

The input to these units is to be provided with a maximum 25A fast-acting (or time-delay) fuse in the ungrounded input lead.

QBVS050A0B Barracuda Series; DC-DC Converter Power Modules

52-60Vdc Input; 12.0Vdc, 50.0A, 600W Output

Feature Descriptions

Overcurrent Protection

To provide protection in a fault output overload condition, the module is equipped with internal current-limiting circuitry and can endure current limiting continuously. If the overcurrent condition causes the output voltage to fall greater than 3.0V from $V_{o,set}$, the module will shut down and remain latched off. The overcurrent latch is reset by either cycling the input power or by toggling the on/off pin for one second. If the output overload condition still exists when the module restarts, it will shut down again. This operation will continue indefinitely until the overcurrent condition is corrected.

A factory configured auto-restart option (with overcurrent and overvoltage auto-restart managed as a group) is also available. An auto-restart feature continually attempts to restore the operation until fault condition is cleared.

Remote On/Off

The module contains a standard on/off control circuit reference to the $V_{IN(-)}$ terminal. Two factory configured remote on/off logic options are available. Positive logic remote on/off turns the module on during a logic-high voltage on the ON/OFF pin, and off during a logic low. Negative logic remote on/off turns the module off during a logic high, and on during a logic low. Negative logic, device code suffix "1," is the factory-preferred configuration. The On/Off circuit is powered from an internal bias supply, derived from the input voltage terminals. To turn the power module on and off, the user must supply a switch to control the voltage between the On/Off terminal and the $V_{IN(-)}$ terminal ($V_{on/off}$). The switch can be an open collector or equivalent (see Figure 12). A logic low is $V_{on/off} = -0.3V$ to $0.8V$. The typical $I_{on/off}$ during a logic low ($V_{in}=48V$, On/Off Terminal= $0.3V$) is $147\mu A$. The switch should maintain a logic-low voltage while sinking $200\mu A$. During a logic high, the maximum $V_{on/off}$ generated by the power module is $8.2V$. The maximum allowable leakage current of the switch at $V_{on/off} = 2.4V$ is $130\mu A$. If using an external voltage source, the maximum voltage $V_{on/off}$ on the pin is $14.5V$ with respect to the $V_{IN(-)}$ terminal.

If not using the remote on/off feature, perform one of the following to turn the unit on:

For negative logic, short ON/OFF pin to $V_{IN(-)}$.

For positive logic: leave ON/OFF pin open.

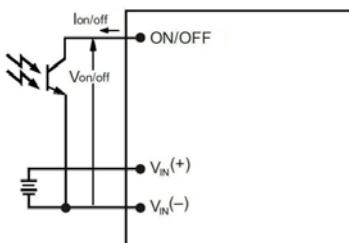

Figure 12. Remote On/Off Implementation.

Output Overvoltage Protection

The module contains circuitry to detect and respond to output overvoltage conditions. If the overvoltage condition causes the output voltage to rise above the limit in the Specifications Table, the module will shut down and remain latched off. The overvoltage latch is reset by either cycling the input power, or by toggling the on/off pin for one second. If the output overvoltage condition still exists when the module restarts, it will shut down again. This operation will continue indefinitely until the overvoltage condition is corrected.

A factory configured auto-restart option (with overcurrent and overvoltage auto-restart managed as a group) is also available. An auto-restart feature continually attempts to restore the operation until fault condition is cleared.

Overtemperature Protection

These modules feature an overtemperature protection circuit to safeguard against thermal damage. The circuit shuts down the module when the maximum device reference temperature is exceeded. The module will automatically restart once the reference temperature cools by $\sim 25^{\circ}C$.

Input Under/Over voltage Lockout

At input voltages above or below the input under/over voltage lockout limits, module operation is disabled. The module will begin to operate when the input voltage level changes to within the under and overvoltage lockout limits.

Thermal Considerations

The power modules operate in a variety of thermal environments and sufficient cooling should be provided to help ensure reliable operation.

Thermal considerations include ambient temperature, airflow, module power dissipation, and the need for increased reliability. A reduction in the operating temperature of the module will result in an increase in reliability. The thermal data presented here is based on physical measurements taken in a wind tunnel. Heat-dissipating components are mounted on the top side of the module. Heat is removed by conduction, convection and radiation to the surrounding environment. Proper cooling can be verified by measuring the thermal reference temperature (TH_1).

Peak temperature occurs at the position indicated in Figure 16. For reliable operation this temperature should not exceed $TH_1=100^{\circ}C$. For extremely high reliability you can limit this temperature to a lower value. The output power of the module should not exceed the rated power for the module as listed in the Ordering Information table.

QBVS050A0B Barracuda Series; DC-DC Converter Power Modules
52-60Vdc Input; 12.0Vdc, 50.0A, 600W Output

Feature Descriptions (continued)

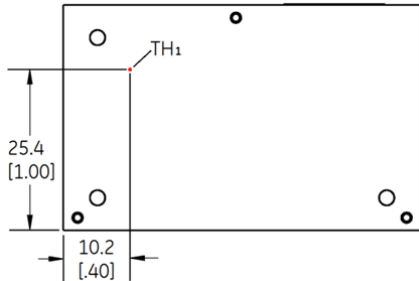

Figure 16. Location of the thermal reference temperature TH₁ for base plate module.

Heat Transfer via Convection

The thermal data presented here is based on physical measurements taken in a wind tunnel, using automated thermo-couple instrumentation to monitor key component temperatures: FETs, diodes, control ICs, magnetic cores, ceramic capacitors, opto-isolators, and module pwb conductors, while controlling the ambient airflow rate and temperature. For a given airflow and ambient temperature, the module output power is increased, until one (or more) of the components reaches its maximum derated operating temperature, as defined in IPC-9592A. This procedure is then repeated for a different airflow or ambient temperature until a family of module output derating curves is obtained. Please refer to the Application Note "Thermal Characterization Process For Open-Frame Board-Mounted Power Modules" for a detailed discussion of thermal aspects including maximum device temperatures.

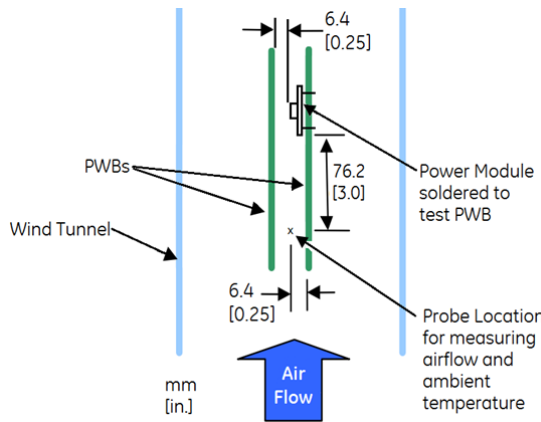

Figure 17. Thermal Test Setup .

Increased airflow over the module enhances the heat transfer via convection. The thermal derating of figure 18-21 shows the maximum output current that can be delivered by each module in the indicated orientation without exceeding the maximum TH_x temperature versus local ambient temperature (T_A) for several air flow conditions.

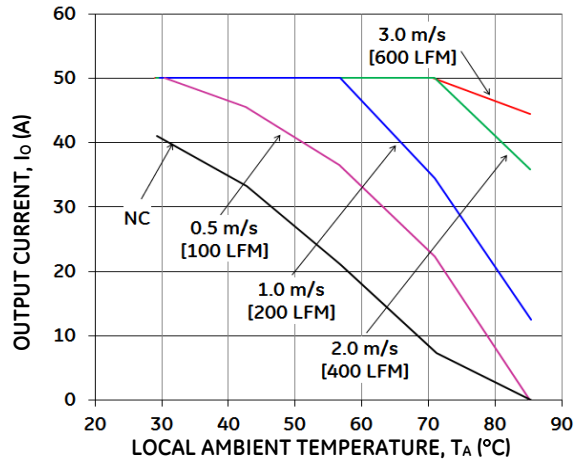

Figure 18. Output Current Derating for the QBVS050A0Bxx-H in the Transverse Orientation; Airflow Direction from Vin(-) to Vin(+); Vin = 54V.

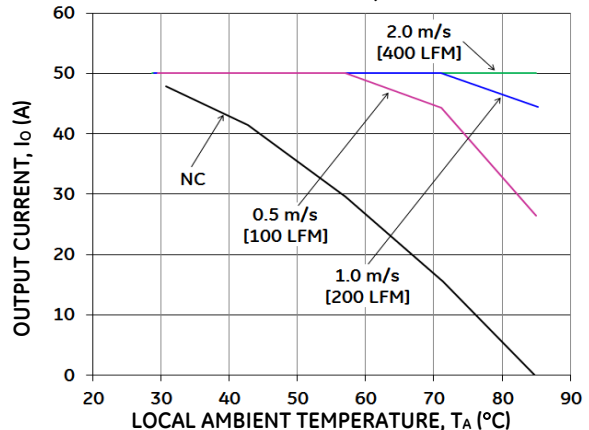

Figure 19. Output Current Derating for the QBVS050A0Bxx-H + 0.5" Heat Sink in the Transverse Orientation; Airflow Direction from Vin(-) to Vin(+); Vin = 54V.

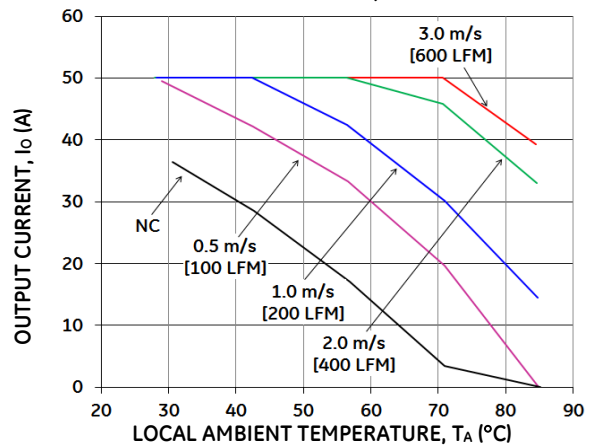

Figure 20. Output Current Derating for the QBVS050A0Bxx-H in the Longitudinal Orientation; Airflow Direction from Vout to Vin; Vin = 54V.

QBVS050A0B Barracuda Series; DC-DC Converter Power Modules
 52-60Vdc Input; 12.0Vdc, 50.0A, 600W Output

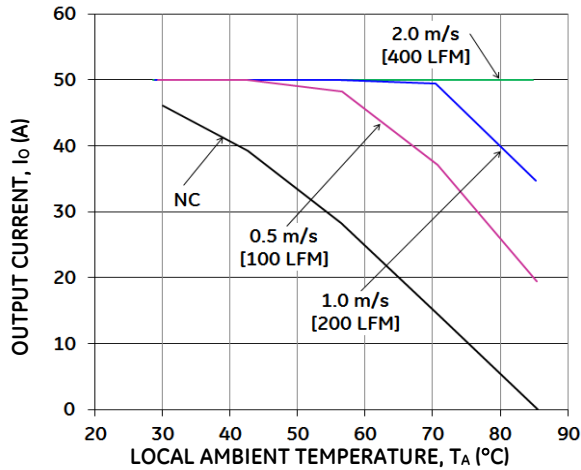

Figure 21. Output Current Derating for the QBVS050A0Bxx-H + 0.5" Heat Sink in the Longitudinal Orientation; Airflow Direction from Vout to Vin; Vin = 54V.

Layout Considerations

The QBVS050A0B power module series are low profile in order to be used in fine pitch system card architectures. As such, component clearance between the bottom of the power module and the mounting board is limited. Avoid placing copper areas on the outer layer directly underneath the power module. Also avoid placing via interconnects underneath the power module.

For additional layout guide-lines, refer to FLT012A0Z Data Sheet.

Through-Hole Lead-Free Soldering Information

The RoHS-compliant, Z version, through-hole products use the SAC (Sn/Ag/Cu) Pb-free solder and RoHS-compliant components. The module is designed to be processed through single or dual wave soldering machines. The pins have a RoHS-compliant, pure tin finish that is compatible with both Pb and Pb-free wave soldering processes. A maximum preheat rate of 3°C/s is suggested. The wave preheat process should be such that the temperature of the power module board is kept below 210°C. For Pb solder, the recommended pot temperature is 260°C, while the Pb-free solder pot is 270°C max.

Reflow Lead-Free Soldering Information

The RoHS-compliant through-hole products can be processed with the following paste-through-hole Pb or Pb-free reflow process.

Max. sustain temperature :
 245°C (J-STD-020C Table 4-2: Packaging Thickness >= 2.5mm / Volume > 2000mm³),

Peak temperature over 245°C is not suggested due to the potential reliability risk of components under continuous high-temperature.

Min. sustain duration above 217°C : 90 seconds
 Min. sustain duration above 180°C : 150 seconds
 Max. heat up rate: 3°C/sec
 Max. cool down rate: 4°C/sec
 In compliance with JEDEC J-STD-020C spec for 2 times reflow requirement.

Pb-free Reflow Profile

BMP module will comply with J-STD-020 Rev. D (Moisture/Reflow Sensitivity Classification for Nonhermetic Solid State Surface Mount Devices) for both Pb-free solder profiles and MSL classification procedures. BMP will comply with JEDEC J-STD-020C specification for 3 times reflow requirement. The suggested Pb-free solder paste is Sn/Ag/Cu (SAC). The recommended linear reflow profile using Sn/Ag/Cu solder is shown in Figure 24.

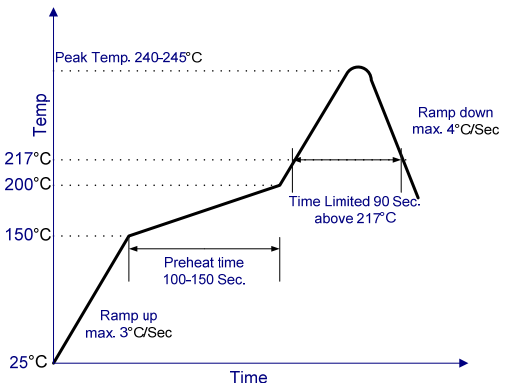

Figure 22. Recommended linear reflow profile using Sn/Ag/Cu solder.

MSL Rating

The QBVS050A0B modules have a MSL rating of 2a.

Storage and Handling

The recommended storage environment and handling procedures for moisture-sensitive surface mount packages is detailed in J-STD-033 Rev. A (Handling, Packing, Shipping and Use of Moisture/Reflow Sensitive Surface Mount Devices). Moisture barrier bags (MBB) with desiccant are required for MSL ratings of 2 or greater. These sealed packages should not be broken until time of use. Once the original package is broken, the floor life of the product at conditions of ≤30°C and 60% relative humidity varies according to the MSL rating (see J-STD-060A). The shelf life for dry packed SMT packages will be a minimum of 12 months from the bag seal date, when stored at the following conditions: < 40° C, < 90% relative humidity.

QBVS050A0B Barracuda Series; DC-DC Converter Power Modules

52-60Vdc Input; 12.0Vdc, 50.0A, 600W Output

Post Solder Cleaning and Drying Considerations

Post solder cleaning is usually the final circuit board assembly process prior to electrical board testing. The result of inadequate cleaning and drying can affect both the reliability of a power module and the testability of the finished circuit board assembly. For guidance on appropriate soldering, cleaning and drying procedures, refer to Lineage Power Board Mounted Power Modules: Soldering and Cleaning Application Note (AN04-001).

If additional information is needed, please consult with your GE Sales representative for more details

QBVS050A0B Barracuda Series; DC-DC Converter Power Modules

52-60Vdc Input; 12.0Vdc, 50.0A, 600W Output

EMC Considerations

The circuit and plots in Figure 23 shows a suggested configuration to meet the conducted emission limits of

EN55022 Class A. For further information on designing for EMC compliance, please refer to the FLT012A0Z data sheet.

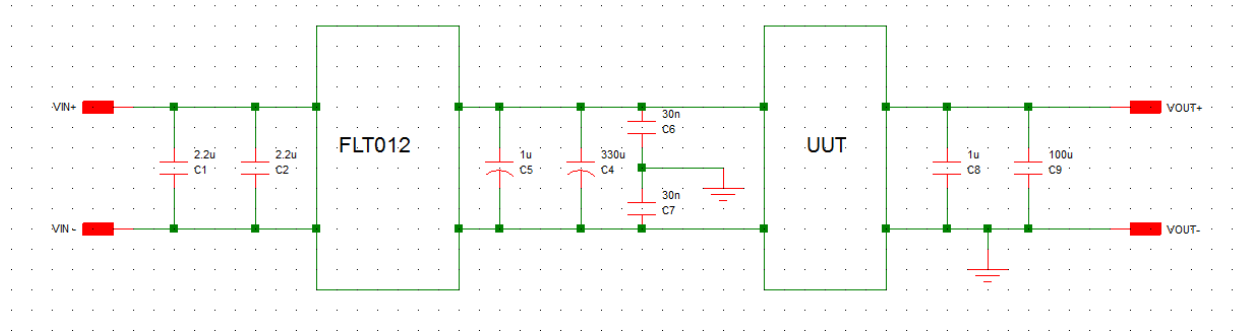

- C1 & C2 = 2.2uF 100V 1210
- C4 = 330uF 100V Nichicon VR series
- C5 & C8 = 1uF 100V 1210
- C6 & C7 = total of six 0.01uF 1500V 1210 caps
- C9 = 1000uF 100V KME series

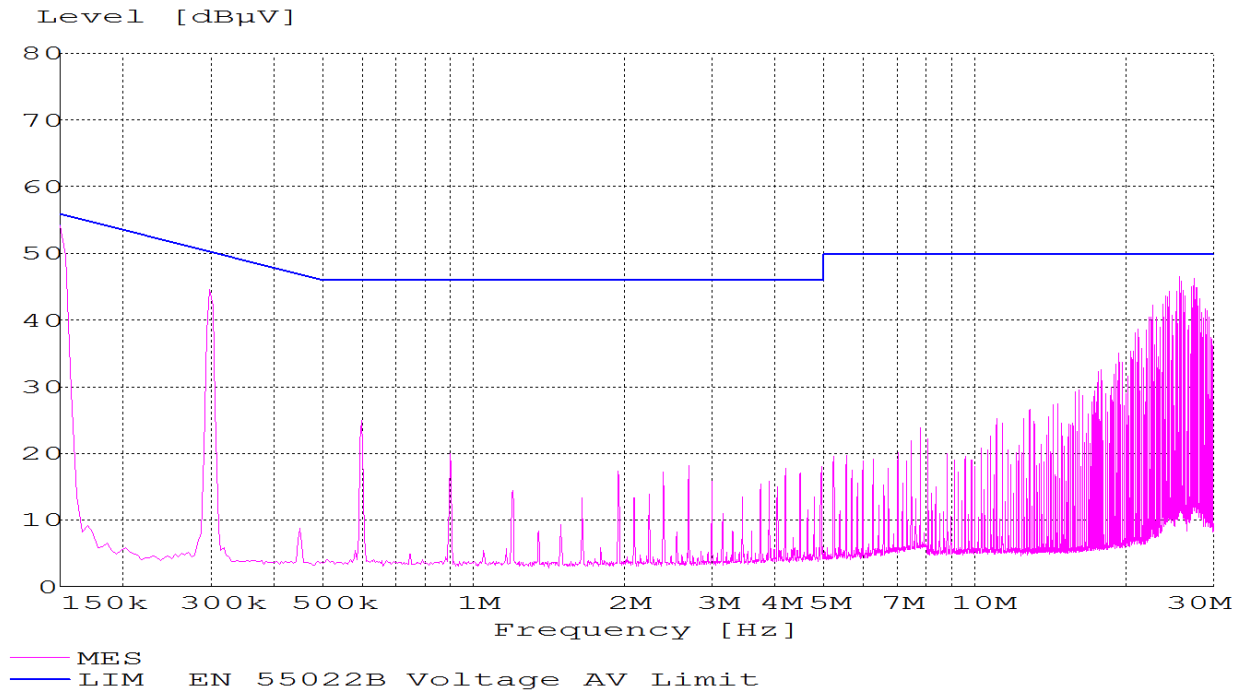

Figure 23. EMC Considerations

QBVS050A0B Barracuda Series; DC-DC Converter Power Modules

52-60Vdc Input; 12.0Vdc, 50.0A, 600W Output

Mechanical Outline for QBVS050A0B-H (Base plate) Through-hole Module

Dimensions are in millimeters and [inches].

Tolerances: x.x mm ± 0.5 mm [x.xx in. ± 0.02 in.] (Unless otherwise indicated)

x.xx mm ± 0.25 mm [x.xxx in ± 0.010 in.]

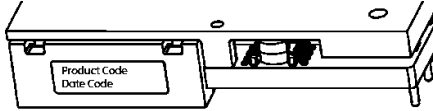
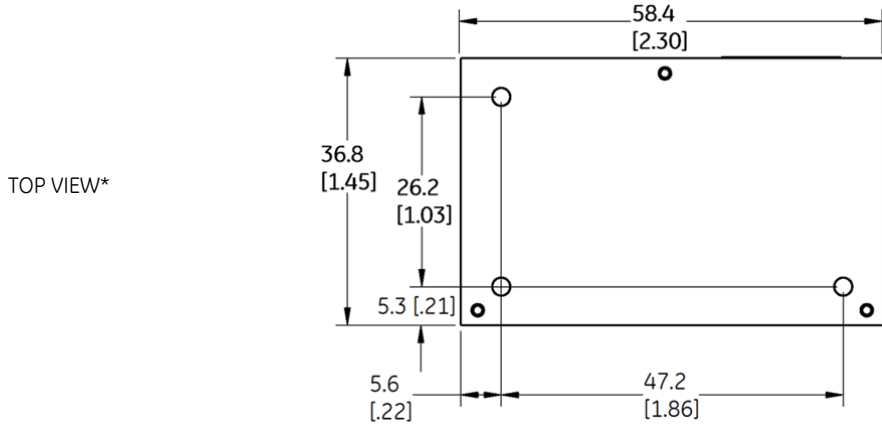

*Side side label includes GE name, product designation, and data code

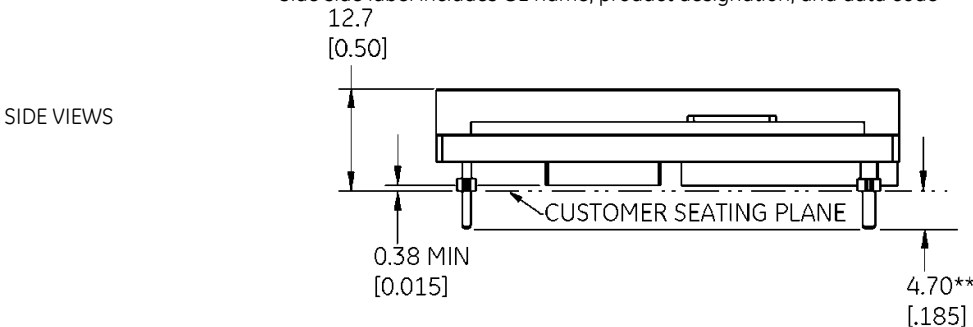

** Standard pin tail length. Optional pin tail lengths shown in Table 2, Device Options.

BOTTOM VIEW***

Pin Number	Pin Name
1	VIN(+)
2	ON/OFF
3	VIN(-)
4	VOUT(-)
8	VOUT(+)

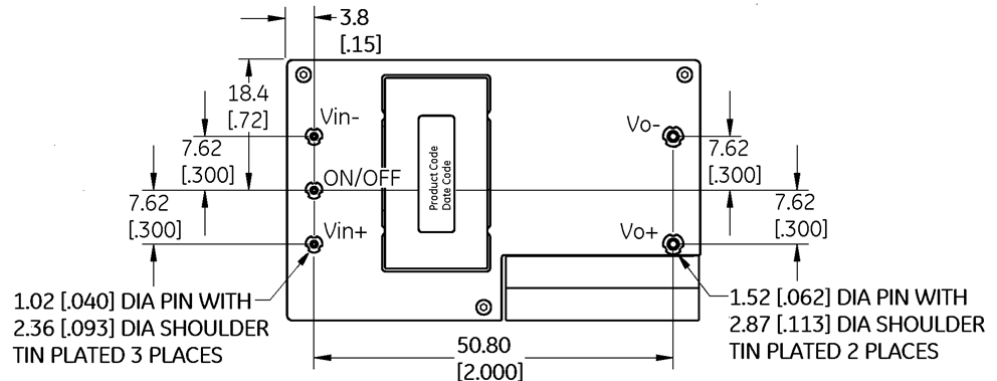

***Bottom side label includes GE name, product designation, and data code

QBVS050A0B Barracuda Series; DC-DC Converter Power Modules

52-60Vdc Input; 12.0Vdc, 50.0A, 600W Output

Recommended Pad Layouts

Dimensions are in millimeters and (inches).
 Tolerances: x.x mm ± 0.5 mm [x.xx in. ± 0.02 in.] (unless otherwise indicated)
 x.xx mm ± 0.25 mm [x.xxx in. ± 0.010 in.]

Through-Hole Modules

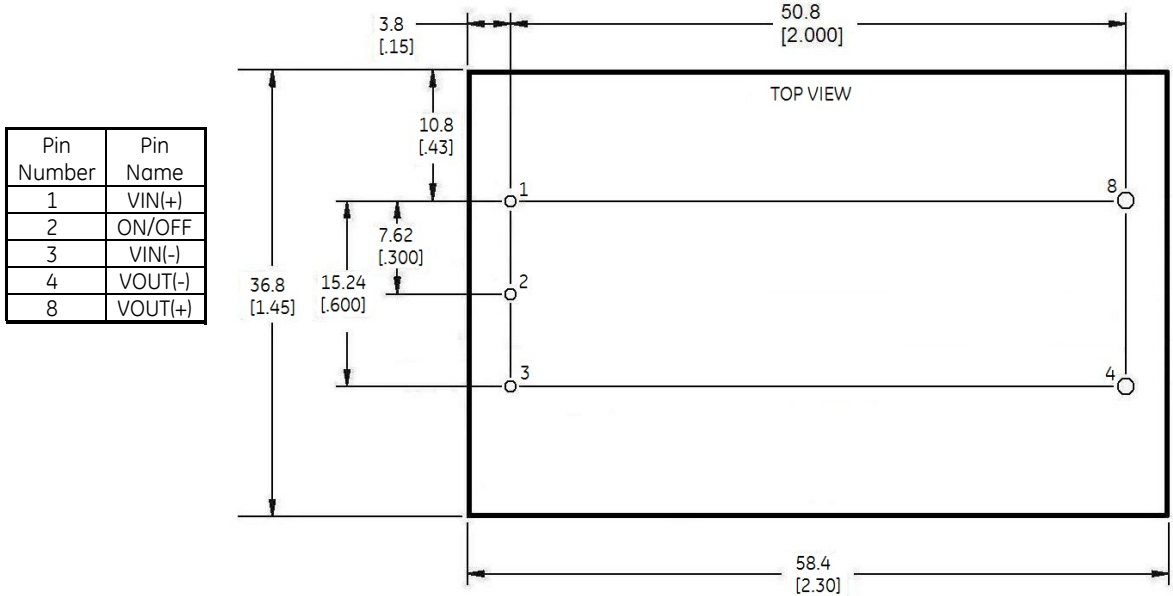

Hole and Pad diameter recommendations:

Pin Number	Hole Dia (mm)	Pad Dia (mm)
1, 2, 3	1.6	2.1
4, 8	2.2	3.2

QBVS050A0B Barracuda Series; DC-DC Converter Power Modules

52-60Vdc Input; 12.0Vdc, 50.0A, 600W Output

Packaging Details

All versions of the QBVS050A0B are supplied as standard in the plastic trays shown in Figure 24.

Each tray contains a total of 12 power modules. The trays are self-stacking and each shipping box for the QBVS050A0B module contains 2 full trays plus one empty hold-down tray giving a total number of 24 power modules.

Tray Specification

Material	PET (1mm)
Max surface resistivity	$10^9 - 10^{11} \Omega/\text{PET}$
Color	Clear
Capacity	12 power modules
Min order quantity	24 pcs (1 box of 2 full trays + 1 empty top tray)

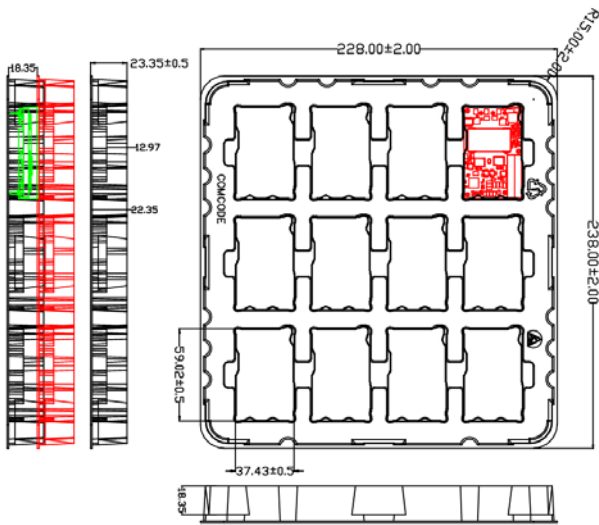

Base Plate Module Tray

Figure 24. QBVS050A0B Packaging Tray

QBVS050A0B Barracuda Series; DC-DC Converter Power Modules

52-60Vdc Input; 12.0Vdc, 50.0A, 600W Output

Ordering Information

Please contact your GE Sales Representative for pricing, availability and optional features.

Table 1. Device Codes

Product codes	Input Voltage	Output Voltage	Output Current	Efficiency	Connector Type	Comcodes
QBVS050A0B41-HZ	54V (52–60Vdc)	12.0V	50.0A	97.1%	Through hole	150031297

Table 2. Device Options

	Characteristic	Character and Position	Definition
Ratings	Form Factor	Q	Q = Quarter Brick
	Family Designator	BV	BV = BARRACUDA Series, without PMBus interface
	Input Voltage	S	S = Special Range, 54V (52V-60V)
	Output Power	050A0	050A0 = 050.0 Amps Maximum Output Current
	Output Voltage	B	B = 12.0V nominal
Options	Pin Length	8 6 5	Omit = Default Pin Length shown in Mechanical Outline Figures 8 = Pin Length: 2.79 mm ± 0.25mm , (0.110 in. ± 0.010 in.) 6 = Pin Length: 3.68 mm ± 0.25mm , (0.145 in. ± 0.010 in.) 5 = Pin Length: 6.35 mm ± 0.25mm , (0.250 in. ± 0.010 in.)
	Action following Protective Shutdown	4	Omit = Latching Mode 4 = Auto-restart following shutdown (Overcurrent/Overvoltage)
	On/Off Logic	1	Omit = Positive Logic 1 = Negative Logic
	Customer Specific	XY	XY = Customer Specific Modified Code, Omit for Standard Code
	Features	H	H = Heat plate, for use with heat sinks or cold-walls (must be ordered)
	RoHS	Z	Z = RoHS 6/6 Compliant, Lead free

Contact Us

For more information, call us at

USA/Canada:

+1 888 546 3243, or +1 972 244 9288

Asia-Pacific:

+86.021.54279977*808

Europe, Middle-East and Africa:

+49.89.878067-280

India:

+91.80.28411633

www.ge.com/powerelectronics

