

# MORNSUN®

## LH40 SERIES

### 40W, AC-DC CONVERTER

LH40series--- converter offered by Mornsun. It features universal input voltage, taking both DC and AC input voltage, high efficiency, high reliability, low power consumption and safer isolation. It offers good EMC performance, certificate IEC/EN61000-4, CISPR22/EN55022, UL60950 and EN60950 standards, and is widely used in industrial, office and electricity applications. For harsh EMC environment, the application circuit in the datasheet is strongly recommended.



RoHS

#### PRODUCT FEATURES

1. Universal input range:85~264VAC/120~370VDC
2. AC and DC all in one (input from the same terminal)
3. Low standby power consumption, high efficiency,3000VAC safe isolation
4. Low ripple and noise
5. Protection of output short circuit, over-current, over-voltage
6. Perfect EMC performance
7. Meet IEC61000, UL60950and IEC60950 standards
8. 3 years product warranty

#### PART NUMBER SYSTEM

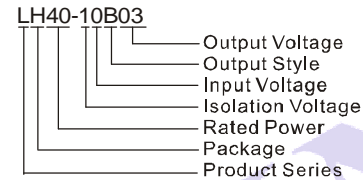

#### SELECTION GUIDE

Model	Package	Power	Output (Vo1/Io1)	Output (Vo2/Io2)	Max. Capacitive Load	Ripple and Noise (Typ.)	Efficiency (230VAC, Typ.)	Standby Power Consumption (Max.)
LH40-10B03	89.0*63.5*25.0mm	26.4W	3.3VDC/800mA	--	60000 uF	50mV	78%	0.5W
LH40-10B05			5VDC/800mA	--	40000 uF		82%	
LH40-10B09			9VDC/444mA	--	12000 uF		84%	
LH40-10B12			12VDC/333mA	--	9000 uF		84%	
LH40-10B15			15VDC/266mA	--	7000 uF		84%	
LH40-10B24			24VDC/166mA	--	2000 uF		84%	
LH40-10D0512-13		40W	5VDC/500mA	12VDC/1250mA	10000/470 uF		82%	
*LH40-10D0524-06			5VDC/500mA	24VDC/625mA	10000/400 uF		82%	
*LH40-10A05			+5VDC/400mA	-5VDC/400mA	±12000 uF		82%	
LH40-10A12			+12VDC/166mA	-12VDC/166mA	±4400 uF		84%	
*LH40-10A15			+15VDC/133mA	-15VDC/133mA	±1000 uF		84%	
*LH40-10C0512-06			5VDC/500mA	±12VDC/600mA	10000/±780 uF		82%	
*LH40-10C0515-05			5VDC/500mA	±15VDC/500mA	10000/±900 uF		82%	

Note:\*Designing

#### INPUT SPECIFICATIONS

Item	Test Conditions	Min.	Typ.	Max.	Unit
Input Voltage Range	AC Input	85	--	264	V
	DC Input	120	--	370	
Input Frequency		47	--	440	Hz
Input Current	115VAC Input	--	--	1.0	A
	230VAC Input	--	--	0.6	
Inrush Current	115VAC Input	--	30	--	
	230VAC Input	--	50	--	

#### OUTPUT SPECIFICATIONS

Item	Test Conditions	Min.	Typ.	Max.	Unit
Output Voltage Accuracy	LH40-10BXX	Main output	--	±2	%
	LH40-10AXX	Main output / Secondary output	--	±2	
	LH40-10DXX	Main output	--	±2	

	LH40-10CXX	Secondary output	--	±5	--	
Line Regulation	LH40-10BXX		--	±0.5	--	%
	LH40-10AXX		--	±0.5	--	
	LH40-10DXX(Main output)		--	±0.5	--	
	LH40-10CXX(Main output)		--	±0.5	--	
Load Regulation	LH40-10DXX(Secondary output)		--	±1.5	--	%
	LH40-10CXX(Secondary output)		--	±1.5	--	
	LH40-10BXX		--	±1	--	
	LH40-10AXX (Balance load)		--	±2	--	
	LH40-10DXX(Balance load)	Main output	--	±2	--	
		Secondary output	--	±5	--	
LH40-10CXX(Balance load)	Main output	--	±3	--		
	Secondary output	--	±5	--		
Ripple& Noise	20MHz bandwidth(p-p)		--	50	100	mV
Min. Load	LH40-10BXX		1	--	--	%
	LH40-10AXX(Balance load)		10	--	--	
	LH40-10DXX(Balance load)		25	--	--	
	LH40-10CXX (Balance load)		25	--	--	
Cross regulation	LH40-10AXX		--	±5	--	%
	LH40-10DXX	Main output	--	±1	--	
		Secondary output	--	±7	--	
	LH40-10CXX	Main output	--	±3	--	
Secondary output		--	±7	--		
Trim	LH40-10BXX		--	--	±10	
Hold-up Time	115VAC Input		--	15	--	ms
	230VAC Input		--	80	--	
Over Voltage Protection	3.3V Output		--	--	5.5	V
	5V Output		--	--	9	
	9V Output		--	--	14	
	12V Output		--	--	20	
	15V Output		--	--	24	
	24V Output		--	--	35	
Short Circuit Protection			Continuous, and auto recovery			
Over Current Protection			≥110 I <sub>o</sub> , and auto recovery			

## COMMON SPECIFICATIONS

Item	Test Conditions	Min.	Typ.	Max.	Unit	
Operating Temperature		-40	--	+70	°C	
Storage Temperature		-40	--	+85		
Storage Humidity		--	--	95	%RH	
Temperature coefficient	Main output	--	±0.02	--	% / °C	
Power derating	-40°C ~ -30°C (LH40-10B03/05)	4.0	--	--		
	-40°C ~ -30°C (LH40-10B09/12/15)	3.0	--	--		
	-40°C ~ -30°C (LH40-10Dxx, LH40-10Axx, LH40-10Cxx)	5.0	--	--		
	+45°C ~ +70°C (LH40-10B03/05)	3.0	--	--		
	+55°C ~ +70°C (LH40-10B09/12/15)	3.7	--	--		
	+55°C ~ +70°C (LH40-10B24)	2.7	--	--		
	+50°C ~ +70°C (LH40-10Dxx, LH40-10Axx, LH40-10Cxx)	3	--	--		
Isolation Resistance		100	--	--	MΩ	
Isolation Voltage	Input-Output	Tested for 1 minute		3000	--	VAC
Switching Frequency		--	65	--	kHz	
Weight		210	225	240	g	
Safety approvals	LH40-10BXX	EN60950/UL60950				
Safety Class		CLASS II				
Safety standards		IEC60950/EN60950/UL60950				
Hot swap		Forbid				

Case Material Grade		UL 94V-0
Install		PCB
Cooling		Free air convection
MTBF		>200000h @ 25°C

Note: 1. Ripple and Noise are measured by the method of parallel lines;  
 2. Unless otherwise specified, all specifications above are measured at rated input voltage and rated output load, Ta=25°C, humidity < 75%.

EMC SPECIFICATIONS				
EMI	CE	CISPR22/EN55022, CLASS B		
	RE	CISPR22/EN55022, CLASS B		
EMS	ESD	IEC/EN61000-4-2	Contract ±6KV/ Air ±8KV	
	RS	IEC/EN61000-4-3	10V/m	
	EFT	IEC/EN 61000-4-4 ±2KV(Without External Circuit )		perf. Criteria B
		IEC/EN 61000-4-4 ±4KV(Recommended Circuit Refer to Figure 3)		
	Surge	IEC/EN 61000-4-5 ±1KV/±2KV(Without External Circuit )		perf. Criteria B
		IEC/EN 61000-4-5 ±2KV/±4KV(Recommended Circuit Refer to Figure 3)		
	CS	IEC/EN61000-4-6	10 Vr.m.s	perf. Criteria A
PFM	IEC/EN61000-4-8	10A/m	perf. Criteria A	
Voltage dips, short and interruptions immunity		IEC/EN61000-4-11	0%- 70%	perf. Criteria B

### PARALLEL LINES MEASURE

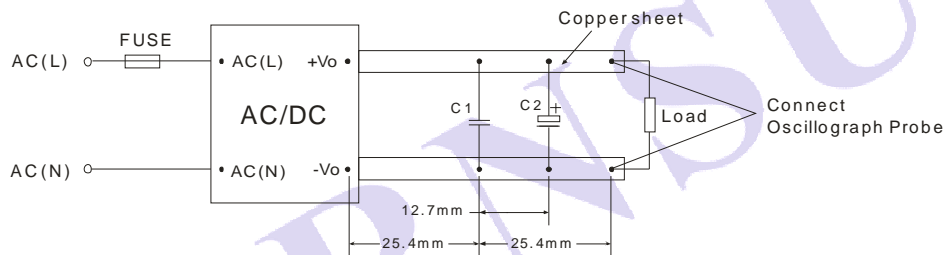

Note: C1: 1µF (Ceramic capacitor) C2: 10µF (Electrolytic capacitor)

### PRODUCT TYPICAL CURVE

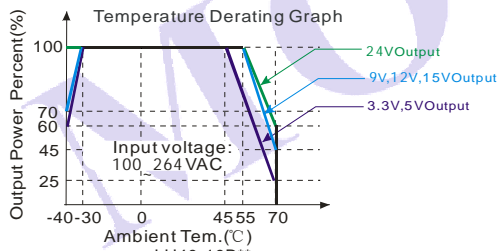

Note: When input 85~100VAC, it need to be voltage derated on basis of temperature derating

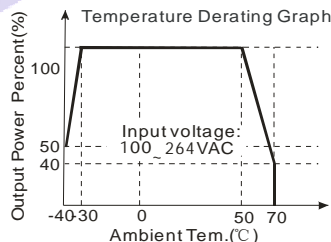

Note: When input 85~100VAC, it need to be voltage derated on basis of temperature derating

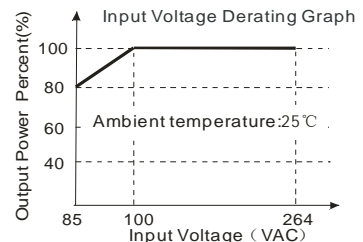

Note: When input DC, VDC=1.414\*VAC-2C

Efficiency VS Input Voltage curve (Full Load)

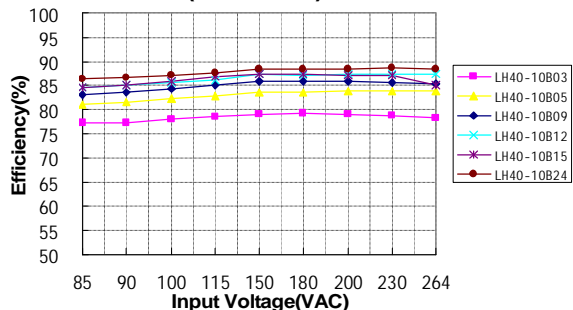

Efficiency VS Output Load curve (Vin=230VAC)

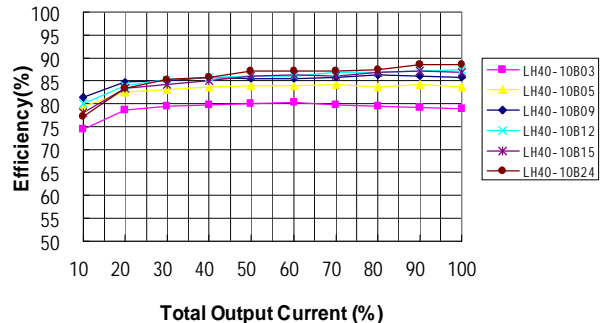

## TRIM APPLICATION & TRIM CALCULATION

### Application circuit for TRIM

(Part in broken line is the interior of models)

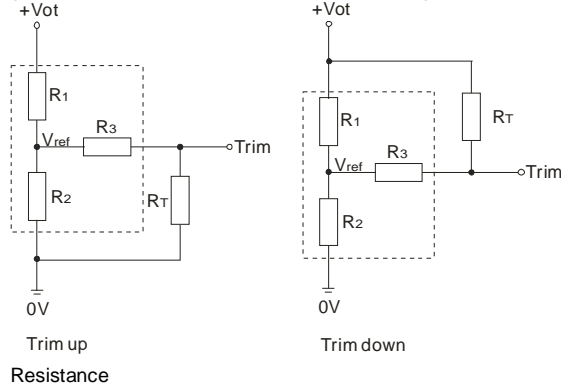

### Formula for resistance of Trim:

$$\text{up: } R_T = \frac{aR_2}{R_2 - a} - R_3 \quad a = \frac{V_{ref}}{V_{ot} - V_{ref}} \cdot R_1$$

$$\text{down: } R_T = \frac{aR_1}{R_1 - a} - R_3 \quad a = \frac{V_{ot} - V_{ref}}{V_{ref}} \cdot R_2$$

Note: Value for R1, R2, R3, and Vref refer to the following table.

R<sub>T</sub>: Resistance of Trim

a: User-defined parameter, no actual meanings.

Vo(V)	3.3	5V	9V	12V	15V	24V
Resistance						
R1(KΩ)	2	3.3	4.7	3.83	4.99	8.66
R2(KΩ)	1.2	3.3	1.8	1	1	1
R3(KΩ)	1	1	1	1	1	1
Vref(V)	1.24	2.5	2.5	2.5	2.5	2.5
Vot(V)	Output voltage of Trim, variation ≤ ±10%					

## TYPICAL APPLICATIONS

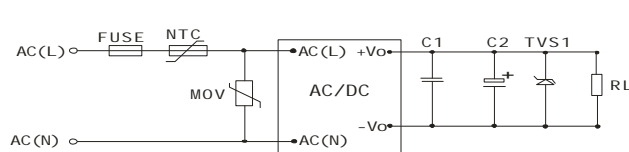

(Figure 1): LH40-10B\*\* Typical application circuit

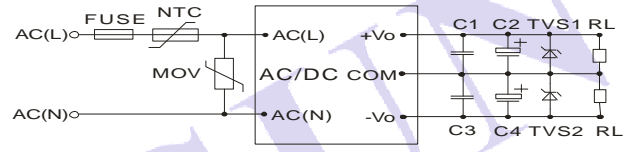

(Figure 2): LH40-10A\*\* Typical application circuit

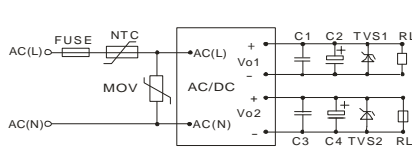

(Figure 3): LH40-10D\*\* Typical application circuit

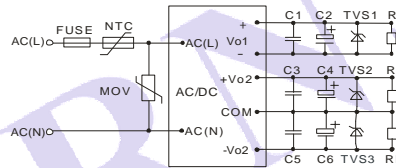

(Figure 4): LH40-10C\*\* Typical application circuit

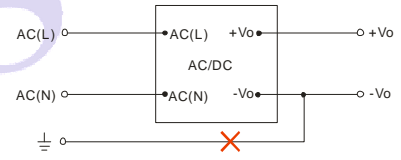

(Figure 5): This application is not available for this series.

Note: If you have such application, please consult to our FAE department

## EMC RECOMMENDED CIRCUIT

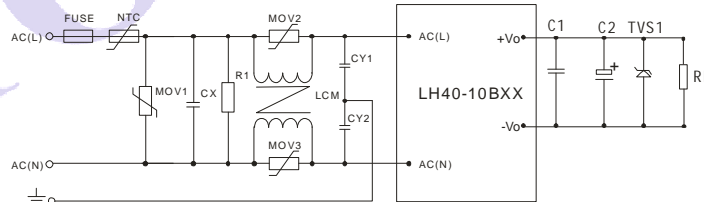

(Figure 6): Recommended circuit for applications which require higher EMC standard (external circuit output is the same as figure 1)

## EMC RECOMMENDED CIRCUIT PCB LAYOUT

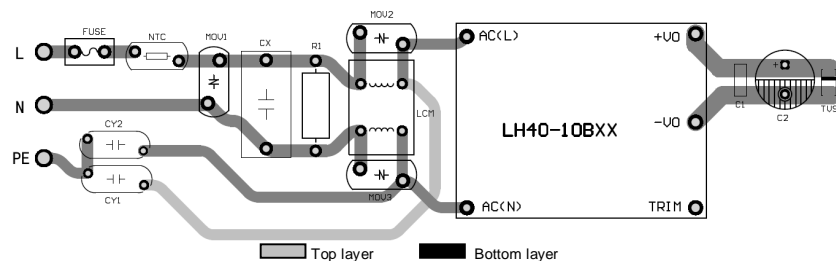

(figure 7): EMC application circuit PCB layout

Safety and recommend wiring: line width ≥3mm, line-line distance ≥6mm, line- ground distance ≥6mm

EXTERNAL CIRCUIT PARAMETERS							
Model	C2(uF)	C4(uF)	C6(uF)	C1, C3, C5 (uF)	TVS 1	TVS 2	TVS 3
LH40-10B03	680	\	\	1	SMBJ7.0A	\	\
LH40-10B05	680	\	\	1	SMBJ7.0A	\	\
LH40-10B09	330	\	\	1	SMBJ12A	\	\
LH40-10B12	220	\	\	1	SMBJ20A	\	\
LH40-10B15	220	\	\	1	SMBJ20A	\	\
LH40-10B24	120	\	\	1	SMBJ30A	\	\
LH40-10D0512-13	680	220	\	1	SMBJ7.0A	SMBJ20A	\
LH40-10D0524-06	680	120	\	1	SMBJ7.0A	SMBJ30A	\
LH40-10A05	680	680	\	1	SMBJ7.0A	SMBJ7.0A	\
LH40-10A12	220	220	\	1	SMBJ20A	SMBJ20A	\
LH40-10A15	220	220	\	1	SMBJ20A	SMBJ20A	\
LH40-10C0512-06	680	220	220	1	SMBJ7.0A	SMBJ20A	SMBJ20A
LH40-10C0515-05	680	220	220	1	SMBJ7.0A	SMBJ20A	SMBJ20A

Note:

1. Output filtering capacitors C2 is a electrolytic capacitor, It is recommended to use high frequency and low impedance electrolytic capacitors . For capacitance and current of capacitor please refer to manufacture's datasheet. Voltage derating of capacitor should be 80% or above. C1 is ceramic capacitor. It is used to filter high frequency noise. TVS is a recommended component to protect post-circuits (if converter fails).

2. For standard EMC requirement, please refer to figure 1 to figure 4.If higher EMC requirement , please refer to figure 6 (LH40-10Axx/LH40Dxx/LH40-10Cxx Adjust the corresponding output circuit) , recommended parameters are shown in the table below.

Recommend Parameter For Higher EMC Standard Circuit	
Components	Recommend Parameter
MOV1	S14K350
MOV2, MOV3	S07K350
CX	0.15μF/300VAC
CY1	2.2nF/400VAC
CY2	2.2nF /400VAC
R1	1MΩ/2W
LCM	2.2mH, recommended to use MORNSUN's FL2D-10-222
NTC	5D-14
FUSE	3.15A/250V, slow blow, it must be connected to FUSE

## DIMENSIONS, RECOMMENDED FOOTPRINT & PACKAGING

**MECHANICAL DIMENSIONS**

Front view dimensions: 25.00 (0.984), 6.00 (0.236), 01.20 (0.047), 89.00 (3.504), 81.30 (3.201).

Bottom view dimensions: 68.50 (2.7), 35.40 (1.4), 56.88 (2.2), 2, 7, 6, 4, 3, 5, 1.

PIN CONNECTION				
Pin	LH40-10A	LH40-10B	LH40-10C	LH40-10D
1	AC(L)	AC(L)	AC(L)	AC(L)
2	AC(N)	AC(N)	AC(N)	AC(N)
3	+Vo	+Vo	+Vo2	+Vo2
4	No Pin	No Pin	+Vo1	+Vo1
5	COM	-Vo	COM(Vo2)	-Vo2
6	No Pin	No Pin	-Vo1	-Vo1
7	-Vo	Trim	-Vo2	No Pin

Note:  
Unit :mm [inch]  
Pin diameter tolerances :±0.10[±0.004]  
General tolerances:±0.50[±0.020]

THIRD ANGLE PROJECTION

**RECOMMENDED FOOTPRINT DETAILS**

Note : Grid 2.54\*2.54mm

**PACKAGE DIAGRAM**

Note:  
Unit :mm [inch]  
EPE packaging dimensions: L\*W\*H=340\*340\*22.5  
Packaging quantity: 12pcs  
Inner carton dimensions: L\*W\*H=365\*350\*105  
Packaging quantity: 24pcs  
Outer carton dimensions: L\*W\*H=390\*360\*245  
Packaging quantity: 48pcs

### MORNSUN Science & Technology Co.,Ltd.

Address: No. 5, Kehui St. 1, Kehui development center, Science Ave., Guangzhou Science City, Luogang district, Guangzhou, P.R.China.

Tel: 86-20-38601850

Fax: 86-20-38601272

E-mail: [info@mornsun.cn](mailto:info@mornsun.cn)

[Http://www.mornsun-power.com](http://www.mornsun-power.com)

The copyright and authority for the interpretation of the products are reserved by MORNSUN

Specifications subject to change without notice.  
LH40 series 2013.08.28-A/1 Page 5 of 5