

JF SERIES CONFIGURATOR 1 5

REV	DESCRIPTION	BY DATE	APPD
R	REVISED SHEET 1 TABLE PER ER21332	01/21/10	V.B.H. PSM

SEE SHEET 3 FOR NOTES

FOR SELECTIVE LOADING AND OTHER VARIATIONS
THE LAST FOUR POSITIONS ARE REPLACED BY
A FACTORY ASSIGNED DEVIATION NUMBER AS REQUIRED.

STEP 1 SERIES CODE
JF SERIES MINIATURE SIDE MOUNT CONNECTORS

STEP 2 PRIMARY CONTACTS

* CODE	DESCRIPTION
1	Primary Contact Loaded Per STEP 7
2	Primary Contacts Loaded Per STEP 7
3	Primary Contacts Loaded Per STEP 7
4	Primary Contacts Loaded Per STEP 7 (4 Position IN-LINE configuration only)

STEP 3 PRIMARY CONTACT AND MOLDING TYPE

CODE	CONTACT AND MOLD DESCRIPTION
P	Pin
S	Socket

STEP 4 SECONDARY CONTACTS

CODE	DESCRIPTION
1	Secondary Contact Loaded Per STEP 7
2	Secondary Contacts Loaded Per STEP 7
3	Secondary Contacts Loaded Per STEP 7
NONE	Secondary Contacts Loaded Per STEP 7

STEP 5 SECONDARY CONTACT TYPE DESIGNATION

CODE	DESCRIPTION
P	Pin See STEP 7 For Location
S	Socket See STEP 7 For Location
NONE	See STEP 7 For Location Applicable to JF4 Type only. For JF4P Secondary Type = Socket For JF4S Secondary Type = Pin

STEP 9 DIP SOLDER CONTACT DESIGNATION (SEE SHEET 2)

STEP 8 VARIATIONS (SEE SHEET 2)

STEP 7 PRIMARY CONTACT DESIGNATION (SEE SHEET 2)
(PRIMARY AND SECONDARY CONTACT LOCATIONS)

STEP 6 CONTACT & PLATING DESIGNATION

CODE TYPES		DIP SOLDER TAIL FINISHES SEE STEP 9	SOLDER CUP & DIP SOLDER CONTACT MATERIAL		SOLDER CUP TERMINATION		
JF2P JF2P2P JF4P	JF*P*S JF*S*P JF*S		SOCKET	PIN	FINISH	SOLDER CUP TERMINATION	SOCKET CONTACT ENTRY OPTION
NONE	NONE	N/A	Phos Bronze C54400	Brass C36000	8µ In. Gold over NI.	Not Filled	Open
N/A	10	N/A	Phos Bronze C51000		50µ In. Gold over NI.	Filled	Closed
11	11	N/A	Phos Bronze C54400		50µ In. Gold over NI.	Filled	Open
N/A	12	N/A	Berylium Cu C17300		50µ In. Gold over NI.	Not Filled	Closed
N/A	27	N/A	Berylium Cu C17300		8µ In. Gold over NI.	Not Filled	Closed
30	30	N/A	Phos Bronze C51000		30µ In. Gold over NI.	Not Filled	Open
N/A	32	8µ In. Gold over NI.	Phos Bronze C51000		8µ In. Gold over NI.	Not Filled	Closed
34	34	100µ In. Gold over NI.	Phos Bronze C51000		100µ In. Gold over NI.	Not Filled	Closed
N/A	45	50µ In. Gold over NI.	Phos Bronze C51000		50µ In. Gold over NI.	Not Filled	Closed
81	81	N/A	Phos Bronze C54400		100µ In. Gold over NI.	Not Filled	Open
95	95	N/A	Phos Bronze C54400		50µ In. Gold over NI.	Not Filled	Open
N/A	112	N/A	Phos Bronze C54400		30µ In. Gold over NI.	Not Filled	Open
N/A	113	N/A	Phos Bronze C54400	Brass C36000	50µ In. Gold over NI.	Not Filled	Open

UNLESS OTHERWISE SPECIFIED: DIMENSIONS ARE IN INCHES, OR INCHES / MM		 WINCHESTER ELECTRONICS Winchester Electronics Corporation 62 Barnes Industrial Road North Wallingford, Connecticut 06492	
TOLERANCES	MM		
DECIMALS	.xx ±02/0.5 .xxx ±07/0.18	ANGLES :	SCALE: N/A
CUSTOMER DRAWING		TITLE JF SERIES, SIDE MOUNTING, 4 POS. RECTANGULAR, 30/4 IROS. IN-LINE & 2 POS IN-LINE	
DRAWN BONESSI 01/09/95	DATE CHECKED R.M. BRADLEY 2/21/95	DATE 2/21/95	DATE 2/21/95
APPROVED V.B. HARRIS 2/21/95	DATE APPROVED D. REMILLARD 3/1/95	DATE 3/1/95	DATE 3/1/95
19560		SHT. 1 OF 5	REV. R

REV	DESCRIPTION	DATE	APPD
R	REVISED PER ER21332	01/21/95	PSM

JF SERIES CONFIGURATOR 1 5

SEE SHEET 3 FOR NOTES

FOR SELECTIVE LOADING AND OTHER VARIATIONS THE LAST FOUR POSITIONS ARE REPLACED BY A FACTORY ASSIGNED DEVIATION NUMBER AS REQUIRED

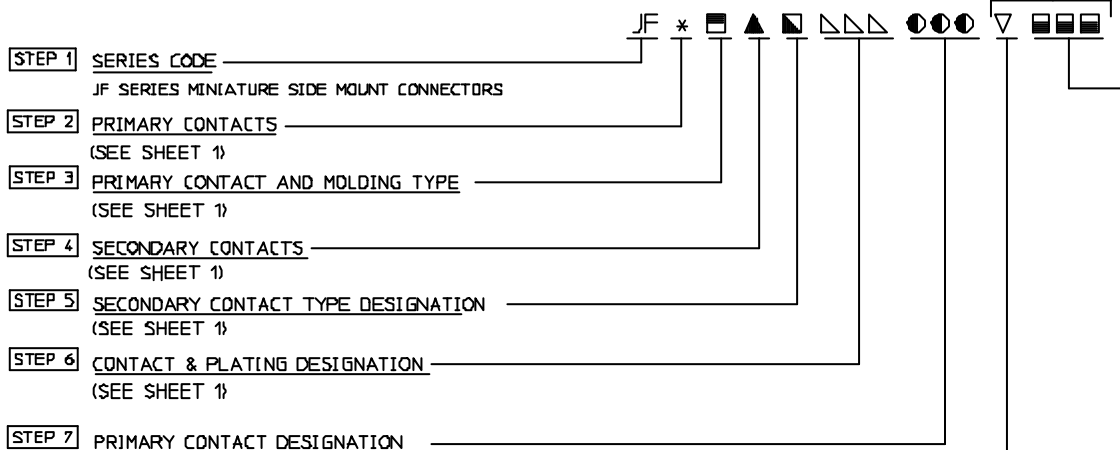

STEP 9 DIP SOLDER CONTACT DESIGNATION
FOR PLATING CODES & MATERIAL, SEE **STEP 6**

DIP SOLDER CODE	DIP SOLDER LENGTH D
D2	2/32
D3	3/32
D4	4/32
D5	5/32
D6	6/32
D11	11/32
D12	12/32
D13	13/32

STEP 7 PRIMARY CONTACT DESIGNATION
(PRIMARY AND SECONDARY CONTACT LOCATIONS)

CODE PRIMARY CONTACT LOCATION DESIGNATION	QUANTITY OF PRIMARY CONTACTS	LOCATION OF SECONDARY CONTACTS	QUANTITY OF SECONDARY CONTACTS	LOADING OPTIONS USED ON
Blank (No Designation Used) All Positions Loaded	4	None	0	JF4P or JF4S, 4 Position In-Line, And JF2P2P or JF2S2S 4 Position Rectangular
A	1	B	1	2 Position In-Line Only
B	1	A	1	
A	1	BCD	3	JF*P▲S or JF*S▲P 4 Position Rectangular and JF4P or JF4S 4 Position In-Line
B	1	ACD	3	
C	1	ABD	3	
D	1	ABC	3	
AB	2	CD	2	
AC	2	BD	2	
AD	2	BC	2	
BC	2	AD	2	
BD	2	AC	2	
CD	2	AB	2	
ABC	3	D	1	
ABD	3	C	1	
BCD	3	A	1	
ACD	3	B	1	

STEP 8 VARIATIONS

▽ CODE	DESCRIPTION
0	No Contact ID Required on Molding Replace Standard Molding with Molding Without Contact ID.
R	"Reverse Molding". Replace Standard Molding Required with "Reverse" Molding.

UNLESS OTHERWISE SPECIFIED
DIMENSIONS ARE IN INCHES OR DECIMALS / MM
TOLERANCES
DECIMALS .XX ±02/05
XXX ±007/018
ANGLES ±
SCALE: N/A

WINCHESTER ELECTRONICS
Winchester Electronics Corporation
62 Barnes Industrial Road North
Wallingford, Connecticut 06492

CUSTOMER DRAWING



TITLE
JF SERIES,
SIDE MOUNTING, 4 PDS RECTANGULAR,
4 PGS. IN-LINE & 2 PDS IN-LINE

DESIGN	DATE	DESIGNED	DATE
BONNESS	01/08/95	R M BRADLEY	2/21/95
APPROVED	DATE	APPROVED	DATE
VB HARRIS	2/21/95	D RENOILLARD	3/1/95

19560	REV 2 of 5	R
-------	------------	---

REV	DESCRIPTION	BY	APPD
R	REVISED PER ER21332	PSM 01/22/90	VJB

SPECIFICATIONS

MATERIALS

Moldings (Pin & Socket) ——— Diallyl Orthophthalate
Color: Grey

Pin contacts ——— Brass

Socket contacts ——— See Configurator

PERFORMANCE CHARACTERISTICS

Dielectric withstanding voltage (at sea level) ——— 1500 VAC

Current rating ——— 7.5 AMPS

Operating temperature range ——— -55°C to +125°C

Termination Type ——— .048 solder cup to accept #20 AWG stranded wire

.025 dia solder pin

NOTES: UNLESS OTHERWISE SPECIFIED

- 1 CATALOG NUMBER CODE: **5**
- 2 FOR THE 4 POSITION RECTANGULAR CONNECTOR STYLE FULLY LOADED WITH ONE CONTACT TYPE, BOTH PRIMARY AND SECONDARY CONTACT TYPE DESIGNATIONS ARE FILLED IN (JF2P2P□□□ OR JF2S2S□□□) AND NO PRIMARY AND SECONDARY CONTACT LOCATION CODE **□□□** **STEP 7** IS REQUIRED.
- 3 JF4P OR JF4S DENOTES ONLY THE 4 POSITION IN-LINE CONNECTOR STYLE LOADED PER **STEP 7**. THIS DESIGNATION IS NOT TO BE USED FOR THE 4 POSITION RECTANGULAR STYLE.
- 4 THIS DESIGNATION DETERMINES THE TYPE OF MOLDING USED AND THE TYPE OF PRIMARY CONTACTS TO BE INSTALLED.
- 5 CONSULT SALES FOR CONNECTOR VARIATIONS NOT LISTED

TYPICAL CONNECTOR ASSEMBLIES

FOR OTHER VARIATIONS, SEE CONFIGURATOR, SHEETS 1 & 2

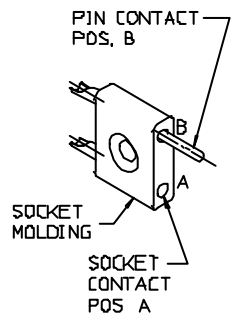

CATALOG NO JF1S1PA
SHOWN

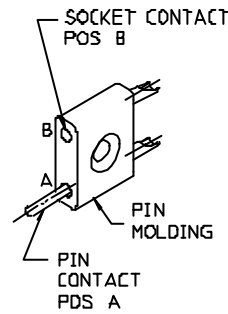

CATALOG NO JF1P1SA
SHOWN

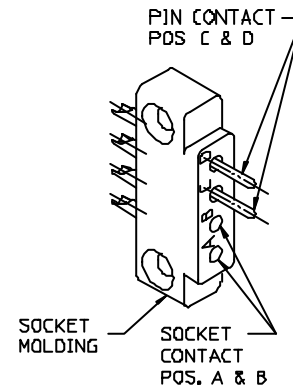

CATALOG NO JF4SAB
SHOWN

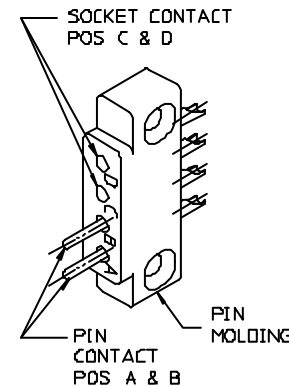

CATALOG NO JF4PAB
SHOWN

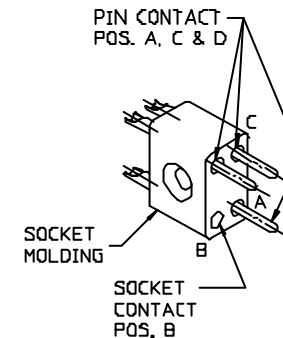

CATALOG NO JF1S3PB
SHOWN

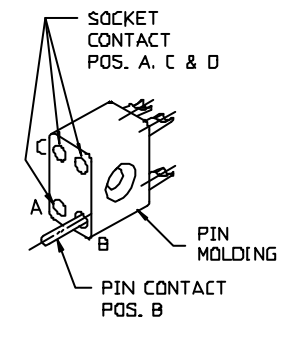

CATALOG NO JF1P3SB
SHOWN

UNLESS OTHERWISE SPECIFIED DIMENSIONS ARE IN INCHES OR INCHES / MM			 Winchester Electronics Corporation 62 Barnes Industrial Road North Wallingford, Connecticut 06492	
TOLERANCES DECIMALS xx ± 0.2/D.5 XXX ± 0.07/D.18 ANGLES c SCALD 21				
CUSTOMER DRAWING			TITLE JF SERIES, SIDE MOUNTING, 4 POS RECTANGULAR, 4 POS, IN-LINE & 2 POS, IN-LINE	
DRAWN BONESSI 01/08/93	DATE CHECKED RM BRADLEY 2/21/95		APPROVED V.J.B. HARRIS 2/21/95	DATE APPROVED D. REHILLARD 3/1/95
PART NUMBER 19560				

REV	DESCRIPTION	BY	APPD
R	REVISED PER ER21332	PSM 01/27/10	V.B.H.

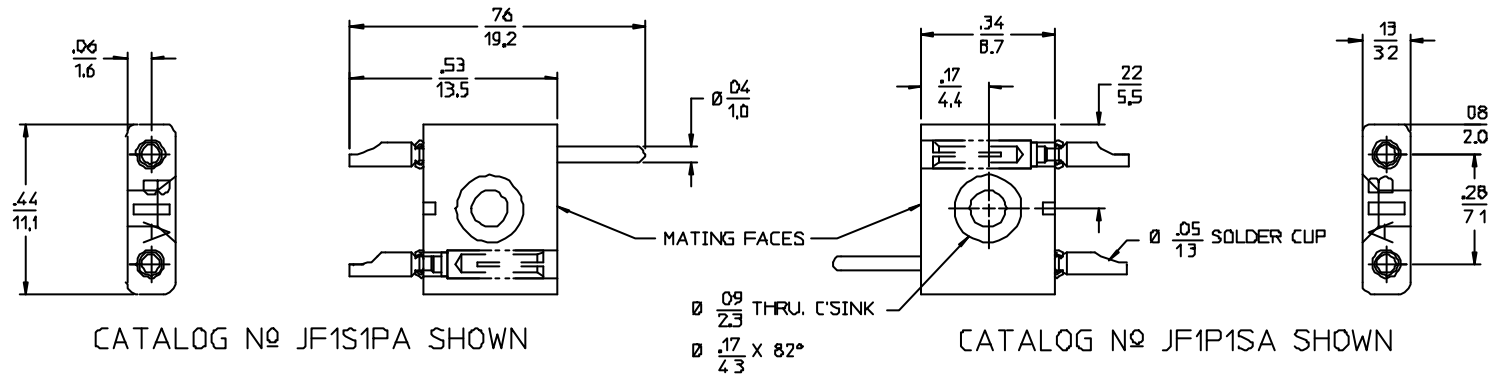

CATALOG NO JF1S1PA SHOWN

CATALOG NO JF1P1SA SHOWN

JF SERIES, PIN AND SOCKET, 2 POSITION IN-LINE CONNECTORS

FOR OTHER VARIATIONS, SEE CONFIGURATOR, SHEETS 1 & 2 [5]
 DIMENSIONS SHOWN ARE TYPICAL FOR ALL STANDARD 2 POS. IN-LINE CONNECTORS

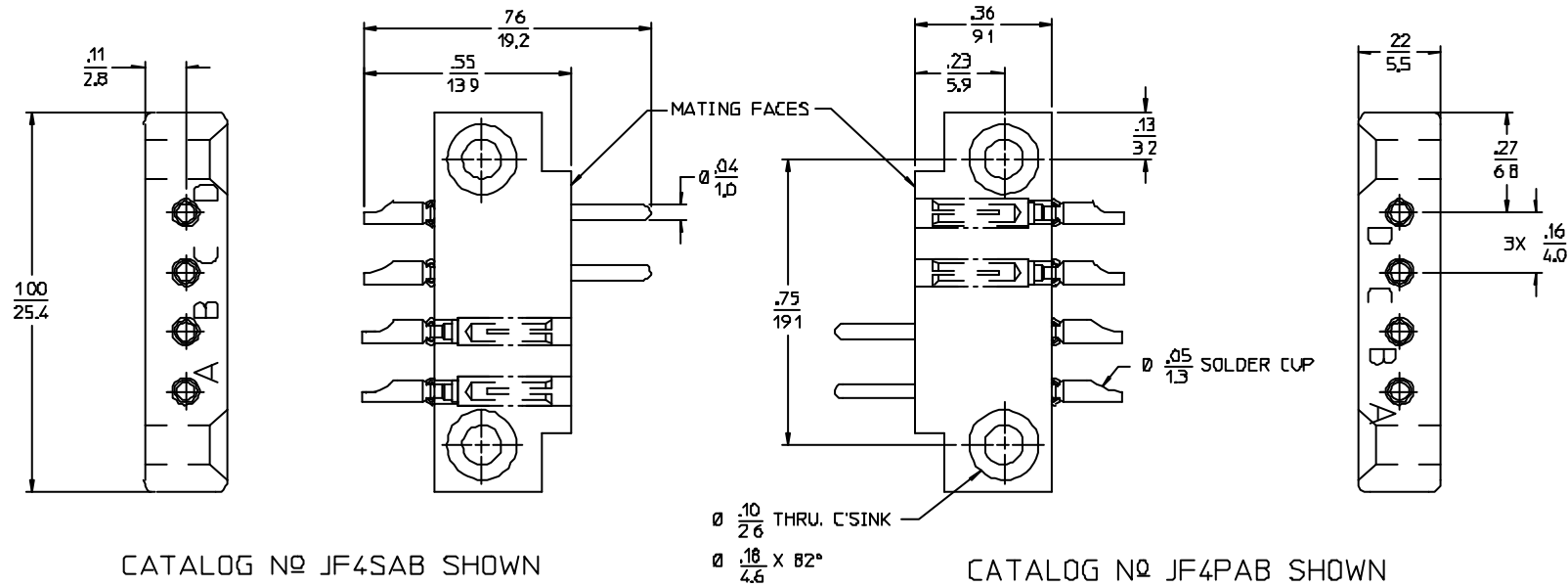

CATALOG NO JF4SAB SHOWN

CATALOG NO JF4PAB SHOWN

JF SERIES, PIN AND SOCKET, 4 POSITION IN-LINE CONNECTORS

FOR OTHER VARIATIONS, SEE CONFIGURATOR, SHEETS 1 & 2 [5]
 DIMENSIONS SHOWN ARE TYPICAL FOR ALL STANDARD 4 POS IN-LINE CONNECTORS

PER ANSI Y14.5M-1987 UNLESS OTHERWISE SPECIFIED DIMENSIONS ARE IN INCHES OR MILLIMETERS TOLERANCES: DECIMALS: XX ± 0.2/0.5, XXX ± 0.007/0.18 ANGLES: °, °/4, °/8 SCALE: 4:1		<p>Winchester Electronics Corporation 62 Barnes Industrial Road North Wallingford, Connecticut 06492</p>
CUSTOMER DRAWING		
DRAWN: BONASSE 01/09/95 APPROVED: V.B. HARRIS 2/21/95	CHECKED: RM BRADLEY 2/21/95 APPROVED: D. RENVILLARD 3/1/05	TITLE: JF SERIES, SIDE MOUNTING, 4 POS RECTANGULAR, 4 POS. IN-LINE & 2 POS IN-LINE PART NO: 19560 REV: 4 OF 5

REV	DESCRIPTION	BY	DATE	APPD
R	REVISED PER ER21332	PSM	01/21/90	V.B.H.

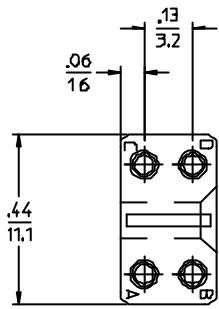

CATALOG NO JF2S2PAB SHOWN

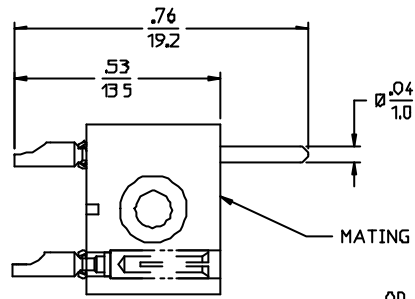

Ø .09 / 2.3 THRU, C'SINK
 Ø .17 / 4.3 x 82°

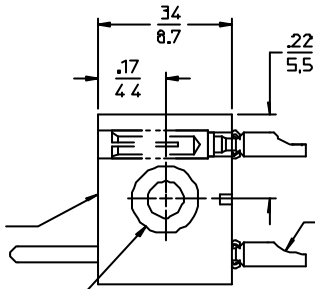

CATALOG NO JF2P2SAB SHOWN

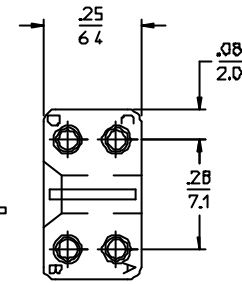

JF SERIES, PIN AND SOCKET, 4 POSITION RECTANGULAR CONNECTORS

FOR OTHER VARIATIONS, SEE CONFIGURATOR, SHEETS 1 & 2 [5]

DIMENSIONS SHOWN ARE TYPICAL FOR ALL STANDARD 4 POS RECTANGULAR CONNECTORS

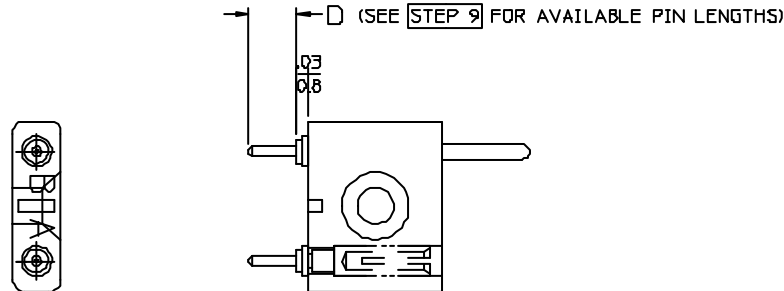

CATALOG NO JF1S1PD4 SHOWN

TYPICAL JF SERIES CONNECTOR WITH DIP SOLDER TERMINATION

FOR OTHER VARIATIONS, SEE CONFIGURATOR, SHEETS 1 & 2 [5]

DIMENSIONS FOR ALL JF SERIES CONNECTORS WITH DIP SOLDER TERMINATIONS ARE IDENTICAL TO JF SERIES CONNECTORS WITH SOLDER CUP TERMINATIONS EXCEPT FOR DIMENSION SHOWN.

PER ANSI Y14.5M-1982 UNLESS OTHERWISE SPECIFIED DIMENSIONS ARE IN INCHES OR INCHES / MM TOLERANCES DECIMALS xx ± 0.2 / 0.5 ANGLES xxx ± 0.07 / 0.18 ANGLES c SCALB 41		Winchester Electronics Corporation 62 Barnes Industrial Road North Wallingford, Connecticut 06492
CUSTOMER DRAWING		
DRAWN BONESS 01/09/95	DATE CHECKED RM BRADLEY 2/21/95	TITLE JF SERIES, SIDE MOUNTING, 4 POS RECTANGULAR, 4 POS, IN-LINE & 2 POS, IN-LINE
APPROVED V.B. HARRIS 2/21/95	DATE APPROVED D. REMILLARD 3/1/95	19560 OF 5 OF 5 REV R