

Features

- Compact size (30.0 x 20.0mm)
- MCU less transceiver module with SPI interface
- High RX sensitivity (-103dBm)
- Outperforming link budget (up to +112dB)
- Up to +9.0dBm output power
- Very low power consumption:
 - 8.7mA in RX mode ⁽¹⁾
 - 27mA in TX mode ⁽¹⁾
 - 0.7µA in sleep mode ⁽²⁾
- Internal clock output
- Preassigned Atmel[®] MAC address that can be used on end product
- Capability to use MAC address into the internal EEPROM
- IEEE[®] 802.15.4 compliant transceiver
- 900MHz ISM band
- Serial bootloader
- Rapid design-in with built-in chip antenna
- RF test point using MS-147 RF connector
- Small physical footprint and low profile for optimum fit in very small application boards
- Mesh networking capability
- Easy-to-use low cost development kit
- Single source of support for HW and SW
- Worldwide license-free operation

Note:

1. RX RPC enabled (for RX current), PHY_TX_PWR=0x0 (for TX current).
2. Controller Sleep Mode: SLEEP_MODE_PWR_DOWN.

Table of Contents

1. Introduction	3
1.1 Summary.....	3
1.2 Applications.....	3
1.3 Abbreviations and Acronyms	4
1.4 Related Documents.....	5
2. ZigBit Module Overview	6
2.1 Overview	6
3. Specification.....	8
3.1 Electrical Characteristics.....	8
3.1.1 Absolute Maximum Ratings	8
3.1.2 Power Supply.....	8
3.1.3 RF Characteristics	9
3.2 Physical/environmental Characteristics and Outline	10
3.3 Pin Configuration.....	10
3.4 Antenna Orientation Recommendation	11
3.5 Mounting Information	11
3.6 Soldering Profile.....	14
4. Schematics	15
4.1 Handling Instructions.....	17
4.2 General Recommendations	17
5. Persistence Memory	18
6. Ordering Information	19
7. Agency Certifications	20
7.1 United States (FCC).....	20
7.2 European Union (ETSI).....	20
7.3 Industry Canada (IC) Compliance statements	21
8. Revision History	22

1. Introduction

1.1 Summary

ATZB-RF-212B-0-CN ZigBit® is an ultra-compact and low-power 900MHz IEEE 802.15.4/ZigBee® OEM module from Atmel. Based on the innovative mixed-signal hardware platform from Atmel, this module uses the AT86RF212B [3] 700/800/900MHz ISM band Transceiver alone on a very compact module design that provides the customer to integrate the module to any of the recommended Atmel Microcontrollers that the application fits. The radio transceiver provides high data rates from 20kb/s up to 1Mb/s, frame handling, outstanding receiver sensitivity and high transmit output power enabling a very robust wireless communication. The module is designed for wireless sensing, monitoring, control, data acquisition applications, to name a few. This ZigBit module eliminates the need for costly and time-consuming RF development, and shortens time-to-market for wireless applications.

The module has an MS-147 RF connector that can be used as an RF test port. The built-in chip antenna is designed and tuned for the ZigBit design to enable quick integration of the ZigBit into any application.

1.2 Applications

The ZigBit module is compatible with robust IEEE 802.15.4/ZigBee stack that supports a self-healing, self-organizing mesh network, while optimizing network traffic and minimizing power consumption.

For detailed Software support information, visit <http://www.atmel.com/products/wireless>.

The applications include, but are not limited to:

- Building automation and monitoring
 - Lighting controls
 - Wireless smoke- and CO-detectors
 - Structural integrity monitoring
- HVAC monitoring and control
- Inventory management
- Environmental monitoring
- Security
- Water metering
- Industrial monitoring
 - Machinery condition and performance monitoring
 - Monitoring of plant system parameters such as temperature, pressure, flow, tank level, humidity, vibration, etc.
- Automated meter reading (AMR)

1.3 Abbreviations and Acronyms

ADC	Analog-to-Digital Converter
API	Application Programming Interface
DC	Direct Current
DTR	Data Terminal Ready
EEPROM	Electrically Erasable Programmable Read-Only Memory
ESD	Electrostatic Discharge
GPIO	General Purpose Input/output
HAF	High Frequency
HVAC	Heating, Ventilating, and Air Conditioning
HW	Hardware
I ² C	Inter-Integrated Circuit
IEEE	Institute of Electrical and Electronics Engineers
IRQ	Interrupt Request
ISM	Industrial, Scientific, and Medical radio band
JTAG	Digital interface for debugging of embedded device, also known as IEEE 1149.1 standard interface
MAC	Medium Access Control layer
MCU	Microcontroller Unit. In this document it also means the processor, which is the core of a ZigBit module
NRE	Network layer
OEM	Original Equipment Manufacturer
OTA	Over-The-Air upgrade
PA	Power Amplifier
PCB	Printed Circuit Board
PER	Package Error Ratio
RAM	Random Access Memory
RF	Radio Frequency
RPC	Reduced Power Consumption
RTS/CTS	Request to Send/ Clear to Send
RX	Receiver
SMA	Surface Mount Assembly
SoC	System on Chip
SPI	Serial Peripheral Interface
SW	Software
TTM	Time-To-Market
TX	Transmitter
UART	Universal Asynchronous Receiver/Transmitter
USART	Universal Synchronous/Asynchronous Receiver/Transmitter
USB	Universal Serial Bus
ZigBee, ZigBee PRO	Wireless networking standards targeted at low-power applications
802.15.4	The IEEE 802.15.4-2003 standard applicable to low-rate wireless Personal Area Network

1.4 Related Documents

- [1] IEEE Std 802.15.4-2003 IEEE Standard for Information technology - Part 15.4 Wireless Medium Access Control (MAC) and Physical Layer (PHY) Specifications for Low-Rate Wireless Personal Area Networks (LR-WPANs).
- [2] ZigBee Specification. ZigBee Document 053474r17, October 19, 2007.
- [3] AT86RF212B Datasheet in <http://www.atmel.com/devices/AT86RF212B.aspx?tab=documents>.
- [4] AT24MAC602 Datasheet in <http://www.atmel.com/devices/AT24MAC602.aspx>.
- [5] MS-147 Series Interface RF Connector with Switch, 3.9mm High, DC to 6GHz
http://www.hirose.co.jp/cataloge_hp/e35801505.pdf.

2. ZigBit Module Overview

2.1 Overview

The ATZB-RF-212B-0-CN ZigBit is a compact, low-power, high sensitivity IEEE 802.15.4/ZigBee OEM module. Based on a solid combination of the latest Atmel MCU Wireless hardware platform, 900MHz ISM band transceiver and Atmel Studio Wireless Composer - the ZigBit offers an unmatched combination of superior radio performance, ultra-low power consumption and exceptional ease of integration.

Figure 2-1. ATZB-RF-212B-0-CN User Interface Diagram

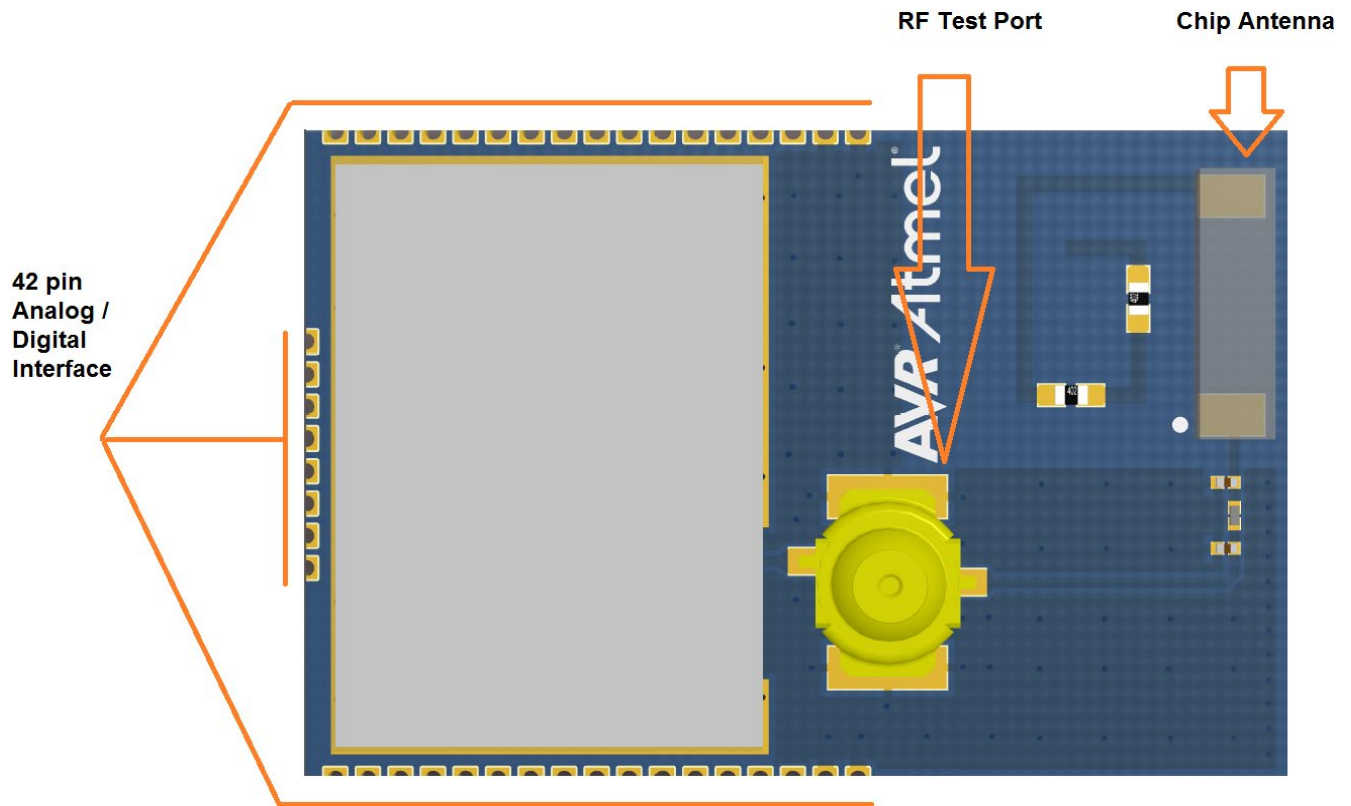

This ZigBit module contains the Atmel AT86RF212B 900MHz ISM band Transceiver for ZigBee and IEEE 802.15.4 [1]. The compact all-in-one board design of Radio Transceiver with very minimal components on the RF path to Antenna connector dramatically improves the ZigBit's compact size, range performance on signal transmission and increases its sensitivity. This ensures stable connectivity within a larger coverage area, and helps develop applications on smaller footprint. The MS-147 connector [5] can be used as an RF Test port.

ZigBit Module contains a complete RF design with all the necessary passive components included. The module can be easily mounted on a simple 2-layer PCB with a minimum of required external connection. The ZigBit Module Evaluation kit containing the ZigBit Extension board for the Atmel Xplained PRO HW Evaluation platform can be used to develop FW using the Atmel Studio and evaluate using the Wireless Composer. Compared to a custom RF/MCU solution, a module-based solution offers considerable savings in development time and NRE cost per unit during the HW/FW design, prototyping, and mass production phases of product development.

Depending on end-user design requirements, the ZigBit can operate as a sensor node, where it can be paired with a host processor driving the module over a serial interface.

The MAC stack running on the host processor can then control data transmission. Thus very minimal firmware customization is required for successful module design-in. Third-party sensors can then be connected directly to the host MCU.

Every ZigBit Module come pre loaded with Atmel assigned 64-bit MAC address stored in the EEPROM built-in the module. This unique IEEE MAC address can be used as the MAC address of the end product, so there is no need to buy a MAC address separately for the product using the ZigBit.

3. Specification

3.1 Electrical Characteristics

3.1.1 Absolute Maximum Ratings

Table 3-1. Absolute Maximum Ratings ⁽¹⁾⁽²⁾

Parameter	Minimum	Maximum
Voltage on any pin, except RESET with respect to ground	-0.3V	3.6V ($V_{DD\ max}$)
Input RF level		+10dBm
Current into V_{CC} pins		200mA

- Notes:
1. Absolute Maximum Ratings are the values beyond which damage to the device may occur. Under no circumstances must the absolute maximum ratings given in this table be violated. Stresses beyond those listed under "Absolute Maximum Ratings" may cause permanent damage to the device.
This is a stress rating only. Functional operation of the device at these or other conditions, beyond those indicated in the operational sections of this specification, is not implied. Exposure to absolute maximum rating conditions for extended periods may affect device reliability.
 2. **Attention!** ZigBit is an ESD-sensitive device. Precaution should be taken when handling the device in order to prevent permanent damage.

3.1.2 Power Supply

Table 3-2. Test Conditions (unless otherwise stated), $V_{CC} = 3V$, $T_{amb} = 25^{\circ}C$

Parameter	Range	Unit
Supply voltage, V_{DD}	1.8 to 3.6	V
Current consumption: RX mode	9.3	mA
Current consumption: TX mode, PLL ON	5	mA
Current consumption: TX mode ⁽¹⁾ – BUSY_TX – Transmit state	26.9	mA
Current consumption: TRX_OFF	617	μA
Sleep Current consumption: TRX Sleep	0.7	μA

Note 1: Output TX power (when measuring consumption in TX mode) is +9dBm.

Current consumption depends on multiple factors, including but not limited to, the board design and materials. When this module is assembled on a base board, the MCU current also should be considered in estimating Active and Sleep currents of the product.

3.1.3 RF Characteristics

Table 3-3. RF Characteristics ⁽¹⁾

Parameter	Condition	Range	Unit
Frequency band – FCC and Industry Canada ⁽²⁾		902 – 928	MHz
Numbers of channels (FCC and Industry Canada)		10	
Channel spacing (FCC and Industry Canada)		2	MHz
Frequency band – ETSI (European Union) ⁽²⁾		863 – 870	MHz
Number of channels (European Union)		1	
Transmitter output power	Adjusted in 36 steps	-25 to +11	dBm
Receiver sensitivity	PER = 1%	-103	dBm
On-air data rate		20 up to 1000	Kbps
TX output/ RX input nominal impedance	For balanced	50	Ω
Range (US Band) ⁽³⁾	Open field, LoS, Elevated	180 – 730	m
Range (Euro Band) ⁽³⁾	Open field, LoS, Elevated	140 – 440	m

Table 3-4. TX Power Settings

PHY_TX_PWR 3:0 Register value	Power register setting [dBm]	Output power [dBm] (typical values at RF connector)
C0	11	8.59
C1	10	8.14
80	9	7.43
82	8	5.85
83	7	4.97
84	6	4.1
40	5	3.58
86	4	2.12
00	3	1.4
01	2	0.42
02	1	-0.93
03	0	-2.09
04	-1	-3.16
27	-2	-4.29
91	-6	-7.86
0D	-10	-12.27
15	-18	-19.51
1D	-25	-26.82

Note 1: For detailed characteristics, refer to [3].

Note 2: Appropriate FW (Register selection) must be used for operating this ZigBit in United States, Canada, and European Union.

Note 3: Range measured is Line of Sight and at 10ft elevation from Ground at different combinations of orientations of transmitter and receiver, with special conditions were there is minimal or no RF interference from other sources. For best case orientation of the ZigBits to achieve maximum range, refer to section 3.4.

3.2 Physical/environmental Characteristics and Outline

Table 3-5. Physical Characteristics

Parameters	Value	Comments
Size	30.0 x 20.0mm	
Operating temperature range	-40°C to +85°C	-40°C to +85°C operational

3.3 Pin Configuration

Table 3-6. ATZB-RF-212B-0-CN Pinout Description

Pin out	Pin descriptions	Function
1	AVSS	Analog Ground
2	AVSS	Analog Ground
3	DEVDD	Digital Power input pin
4	DEVDD	Digital Power input pin
5	RST	RESET active low
6	SEL	SPI select, active low
7	MOSI	SPI data input
8	MISO	SPI data output
9	SCLK	SPI clock
10	DIG1	Reserved
11	FEM_CSD	Reserved
32	DIG3	RX TX Indication
33	DIG4	RX TX Indication (Inverted)
34	DIG2	Tx- Rx time-stamp
35	SLP_TR	Controls sleep, deep sleep, transmit start, receive states; active high
36	SCL	TWI- EEPROM
37	SDA	TWI- EEPROM
38	FEM_CPS	Reserved
39	CLKM	Master Clock out put
40	IRQ	Interrupt request signal output
41	DVSS	Digital Ground
42	DVSS	Digital Ground

3.4 Antenna Orientation Recommendation

Direction of best case Line of Sight Range

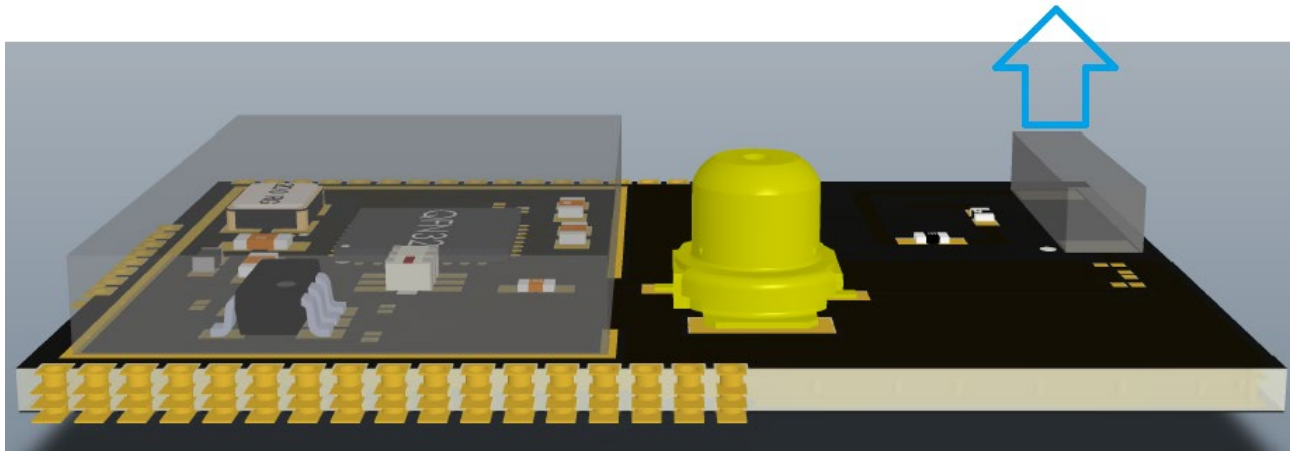

The Antenna in this module is designed to provide the best possible LoS range in the direction indicated in this illustration.

3.5 Mounting Information

Figure 3-1 shows the PCB pinout of a ZigBit module. Neither via-holes nor wires are allowed on the PCB upper layer in the area occupied by the module. As a critical requirement, RF_GND pins should be grounded via several via-holes to be located right next to the pins thus minimizing inductance and preventing both mismatch and losses.

Figure 3-1. ATZB-RF-212B-0-CN Dimensions and Pinout

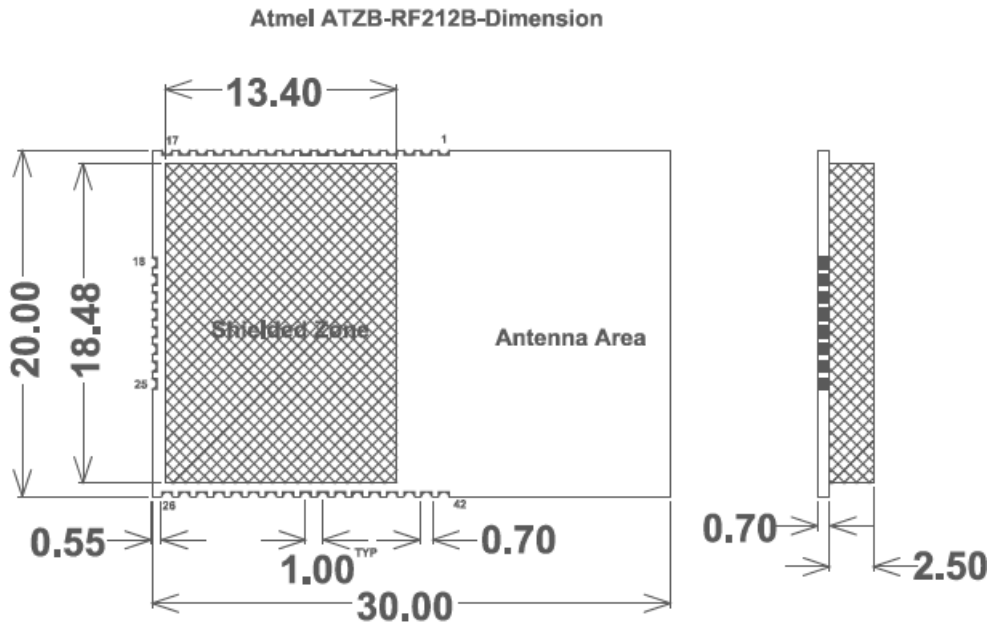

Atmel ATZB-RF212B -Pinout

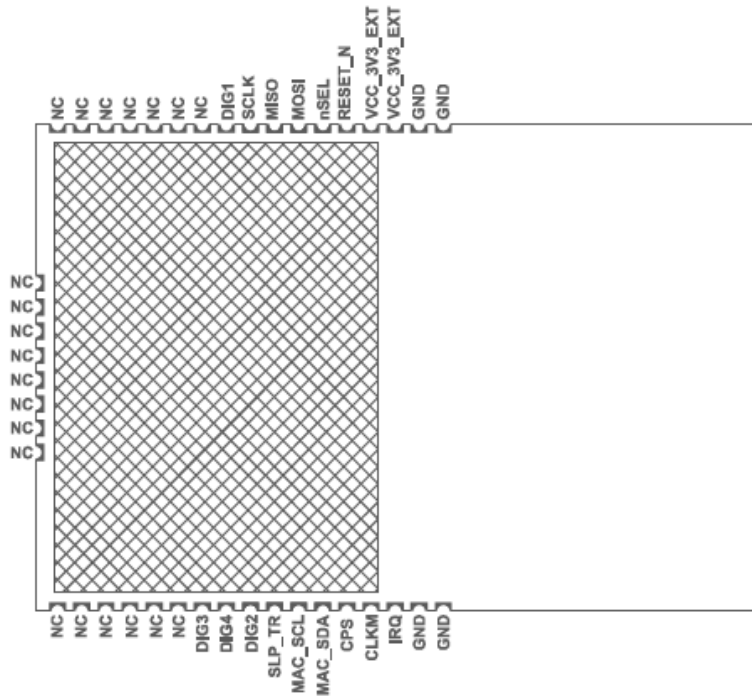

Atmel ATZB-RF212B -Foot Print Dimension

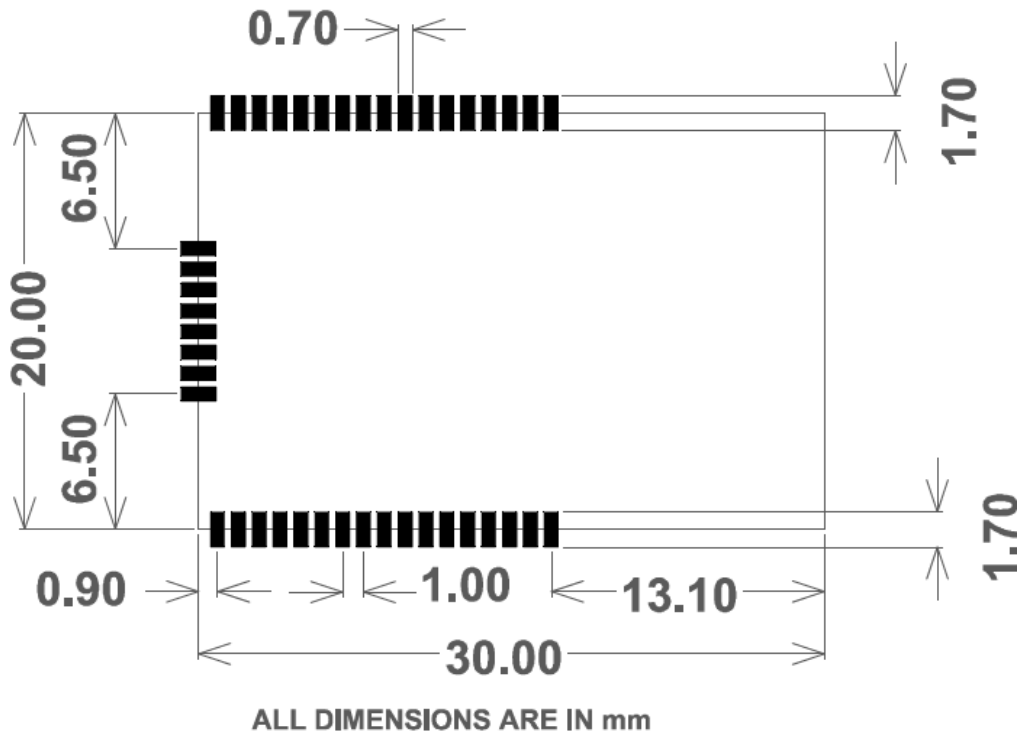

Figure 3-2. ATZB-RF-212B-0-CN Mounting Information (preferred placement)

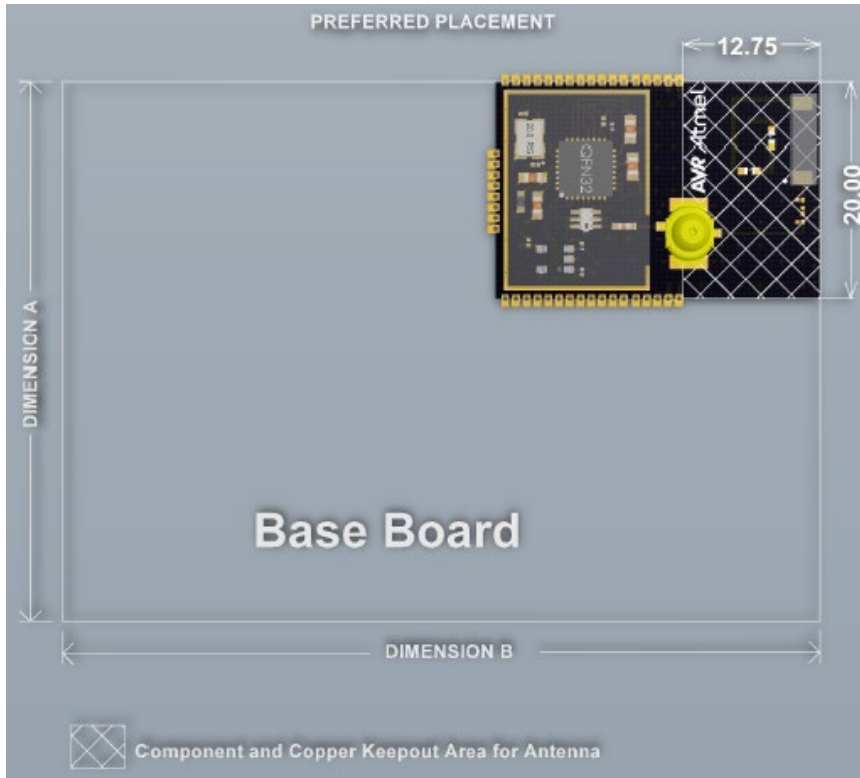
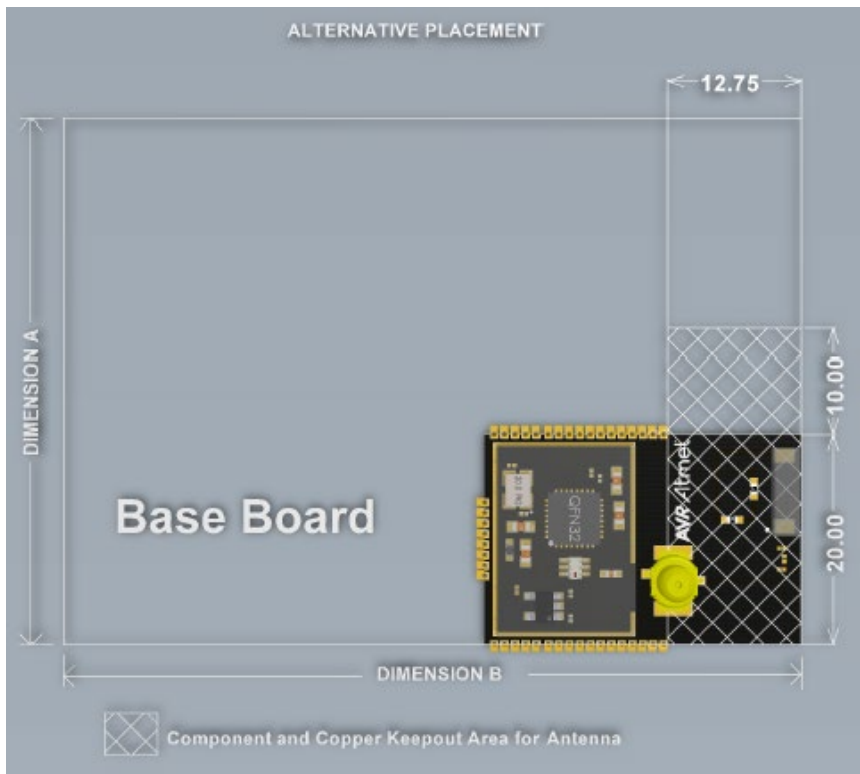

Figure 3-3. ATZB-RF-212B-0-CN Mounting Information (alternative placement)



3.6 Soldering Profile

The J-STD-020C-compliant soldering profile is recommended according to [Table 3-7](#).

Table 3-7. Soldering Profile ⁽¹⁾

Profile feature	Green package
Average ramp-up rate (217°C to peak)	3°C/s max.
Preheat temperature 175°C ±25°C	180s max.
Temperature maintained above 217°C	60s to 150s
Time within 5°C of actual peak temperature	20s to 40s
Peak temperature range	260°C
Ramp-down rate	6°C/s max.
Time within 25°C to peak temperature	8 minutes

Note: 1. The package is backward compatible with PB/Sn soldering profile.

4. Schematics

- Connector schematics

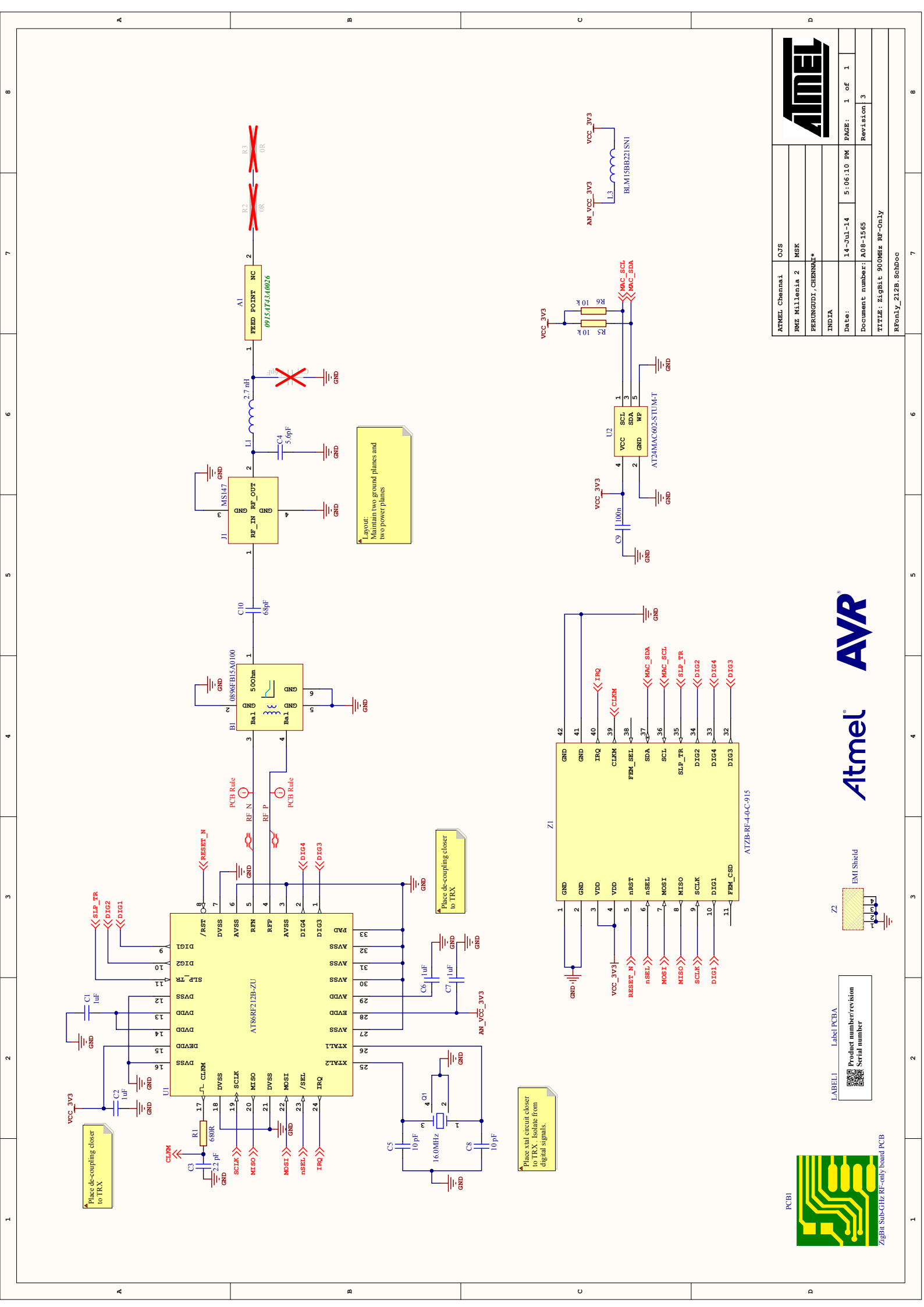

Place decoupling closer to TRX

Layout: Maintain two ground planes and two power planes

Place SLP circuit closer to TRX. Isolate from digital signals.

Place decoupling closer to TRX

ATMEL Chennai	OJS
RMZ Millieria 2	MSK
PENKUNGGI, CHENNAI*	
INDIA	
Date: 14-Jul-14	5:06:10 PM
Document number: A08-1565	
TITLE: ZigBee RF-Only	
RFOnly_212B_SchDoc	

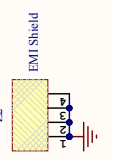
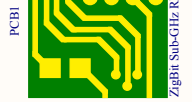

LABEL1 Label PCB A
 Product number/revision
 Serial number

ZigBee Sub-GHz RF-only board PCB

4.1 Handling Instructions

The ZigBit Modules are fixed with an EMI Shield to ensure compliance to Emission and Immunity rules. This shield is galvanic and NOT air tight. So cleaning of the module with IPA / other similar agents is not advised. Humidity protection coating (conformal) will cause deviated RF behavior and coating material being trapped inside EMI Shield. So this should be avoided. For products requiring conformal coating, it is advised to suitably mask the ZigBit before applying the coating to rest of the ZigBit carrier board. To protect ZigBit from humidity, the housing of the product should ensure suitable Ingress Protection standards are complied with.

The UFL RF connector should never be exposed to Varnish / similar conformal coating material which will affect electrical connection on the surfaces of connector.

The in-built chip antenna has been tuned for the particular design.

4.2 General Recommendations

- Metal enclosure should not be used. Using low profile enclosure might also affect antenna tuning.
- Placing high profile components next to antenna should be avoided
- Having holes/vias punched around the periphery of the board eliminates parasitic radiation from the board edges also distorting antenna pattern
- ZigBit module should not be placed next to consumer electronics which might interfere with ZigBit's RF frequency band

5. Persistence Memory

A dedicated memory space is allocated to store product specific information and called the Persistence Memory. The organization of the persistence memory is as follows:

Table 5-1. Persistence Memory

Data	Size
Structure Revision	2 bytes
MAC address ⁽¹⁾	8 bytes
Board information overall	49 bytes
Board information – PCBA Name	30 bytes
Board information – PCBA Serial number	10 bytes
Board information – PCBA Atmel Part Number	8 bytes
Board information – PCBA Revision	1 byte
Reserved	3 bytes
XTAL Calibration Value	1 byte
Reserved	7 bytes
Reserved	4 bytes
CRC	1 byte

Note: 1. The MAC address stored inside the AT24MAC602 is a uniquely assigned ID for each ZigBit and owned by Atmel. User of the ZigBit application can use this unique MAC ID to address the ZigBit in end-applications. The MAC ID can be read from the ZigBit using the Performance Analyzer Application that is supplied through Atmel Studio Gallery Extension.

ATZB-RF-212B-0-CN ZigBit contains AT24MAC602, which has a globally unique MAC address that can be assigned as the physical address of a system hardware device or node. Persistence memory is stored in the first-half of the standard 2kbit EEPROM of AT24MAC602 starting from address 0x00.

Special commands are available to read the unique 64-bit MAC ID and the persistent memory via the I²C compatible (2-wire) serial interface (see section “Device Addressing” in AT24MAC602 [4] for details).

6. Ordering Information

Table 6-1. Ordering Information

Part number	Description
ATZB-RF-212B-0-CN	900MHz IEEE802.15.4/ZigBee OEM module based on AT86RF212B Transceiver with UFL RF connector, Single unit
ATZB-RF-212B-0-CNR	900MHz IEEE802.15.4/ZigBee OEM module based on AT86RF212B Transceiver with UFL RF connector, Tape & Reel

Note: Tape & reel quantity: 200.

7. Agency Certifications

7.1 United States (FCC)

This equipment complies with Part 15 of the FCC rules and regulations. To fulfill FCC Certification requirements, an OEM manufacturer must comply with the following regulations:

1. The ATZB-RF-212B-0-CN modular transmitter must be labeled with its own FCC ID number, and, if the FCC ID is not visible when the module is installed inside another device, then the outside of the device into which the module is installed must also display a label referring to the enclosed module. This exterior label can use wording such as the following:

IMPORTANT: Contains FCC ID: VW4A091743. This equipment complies with Part 15 of the FCC Rules. Operation is subject to the following two conditions: (1) this device may not cause harmful interference, and (2) this device must accept any interference received, including interference that may cause undesired operation (FCC 15.19).

The internal antenna used for this mobile transmitter must provide a separation distance of at least 20cm from all persons and must not be collocated or operating in conjunction with any other antenna or transmitter.

Installers must be provided with antenna installation instructions and transmitter operating conditions for satisfying RF exposure compliance. This device is approved as a mobile device with respect to RF exposure compliance, and may only be marketed to OEM installers. Use in portable exposure conditions (FCC 2.1093) requires separate equipment authorization.

IMPORTANT: Modifications not expressly approved by this company could void the user's authority to operate this equipment (FCC section 15.21).

IMPORTANT: This equipment has been tested and found to comply with the limits for a Class A digital device, pursuant to Part 15 of the FCC Rules. These limits are designed to provide reasonable protection against harmful interference when the equipment is operated in a commercial environment. This equipment generates, uses, and can radiate radio frequency energy and, if not installed and used in accordance with the instruction manual, may cause harmful interference to radio communications. Operation of this equipment in a residential area is likely to cause harmful interference in which case the user will be required to correct the interference at his own expense (FCC section 15.105).

7.2 European Union (ETSI)

The ATZB-X0-256-3-0-C Module has been certified for use in European Union countries. If these modules are incorporated into a product, the manufacturer must ensure compliance of the final product to the European harmonized EMC and lowvoltage/safety standards. A Declaration of Conformity must be issued for each of these standards and kept on file as described in Annex II of the R&TTE Directive.

Furthermore, the manufacturer must maintain a copy of the modules' documentation and ensure the final product does not exceed the specified power ratings, antenna specifications, and/or installation requirements as specified in the user manual. If any of these specifications are exceeded in the final product, a submission must be made to a notified body for compliance testing to all required standards.

IMPORTANT: The 'CE' marking must be affixed to a visible location on the OEM product. The CE mark shall consist of the initials "CE" taking the following form:

The CE marking must have a height of at least 5mm except where this is not possible on account of the nature of the apparatus.

The CE marking must be affixed visibly, legibly, and indelibly.

More detailed information about CE marking requirements you can find at "DIRECTIVE 1999/5/EC OF THE EUROPEAN PARLIAMENT AND OF THE COUNCIL" on 9 March 1999 at section 12.

7.3 Industry Canada (IC) Compliance statements

This device complies with Industry Canada licence-exempt RSS standard(s). Operation is subject to the following two conditions: (1) this device may not cause interference, and (2) this device must accept any interference, including interference that may cause undesired operation of the device.

Le présent appareil est conforme aux CNR d'Industrie Canada applicables aux appareils radio exempts de licence. L'exploitation est autorisée aux deux conditions suivantes: (1) l'appareil ne doit pas produire de brouillage, et (2) l'utilisateur de l'appareil doit accepter tout brouillage radioélectrique subi, même si le brouillage est susceptible d'en compromettre le fonctionnement.

This equipment complies with radio frequency exposure limits set forth by Industry Canada for an uncontrolled environment. This equipment should be installed and operated with minimum distance 20cm between the device and the user or bystanders.

Cet équipement est conforme aux limites d'exposition aux radiofréquences définies par Industrie Canada pour un environnement non contrôlé. Cet équipement doit être installé et utilisé avec un minimum de 20cm de distance entre le dispositif et l'utilisateur ou des tiers.

CAUTION: Any changes or modifications not expressly approved by the party responsible for compliance could void the user's authority to operate the equipment.

The OEM integrator is still responsible for testing their end-product for any additional compliance requirements required with this module installed (for example, digital device emissions, PC peripheral requirements, etc.).

This Module is labelled with its own IC ID. If the IC ID Certification Number is not visible while installed inside another device, then the device should display the label on it referring the enclosed module. In that case, the final end product must be labelled in a visible area with the following:

"Contains Transmitter Module IC: 11019A-091743"

OR

"Contains IC: 11019A-091743"

Ce module est étiqueté avec son propre ID IC. Si le numéro de certification IC ID n'est pas visible lorsqu'il est installé à l'intérieur d'un autre appareil, l'appareil doit afficher l'étiquette sur le module de référence ci-joint. Dans ce cas, le produit final doit être étiqueté dans un endroit visible par le texte suivant:

"Contains Transmitter Module IC: 11019A-091743"

OR

"Contains IC: 11019A-091743"

8. Revision History

Doc. Rev.	Date	Comments
42269B	07/2014	The schematic on page 16 has been updated
42269A	04/2014	Initial document release

**Atmel Corporation**

1600 Technology Drive
San Jose, CA 95110
USA

Tel: (+1)(408) 441-0311

Fax: (+1)(408) 487-2600

www.atmel.com

Atmel Asia Limited

Unit 01-5 & 16, 19F
BEA Tower, Millennium City 5
418 Kwun Tong Road
Kwun Tong, Kowloon

HONG KONG

Tel: (+852) 2245-6100

Fax: (+852) 2722-1369

Atmel Munich GmbH

Business Campus
Parking 4
D-85748 Garching b. Munich
GERMANY

Tel: (+49) 89-31970-0

Fax: (+49) 89-3194621

Atmel Japan G.K.

16F Shin-Osaki Kangyo Building
1-6-4 Osaki, Shinagawa-ku
Tokyo 141-0032
JAPAN

Tel: (+81)(3) 6417-0300

Fax: (+81)(3) 6417-0370

© 2014 Atmel Corporation. All rights reserved. / Rev.: 42269B–WIRELESS–07/2014

Atmel®, Atmel logo and combinations thereof, AVR®, BitCloud®, Enabling Unlimited Possibilities®, ZigBit®, and others are registered trademarks or trademarks of Atmel Corporation or its subsidiaries. Other terms and product names may be trademarks of others.

Disclaimer: The information in this document is provided in connection with Atmel products. No license, express or implied, by estoppel or otherwise, to any intellectual property right is granted by this document or in connection with the sale of Atmel products. EXCEPT AS SET FORTH IN THE ATMEL TERMS AND CONDITIONS OF SALES LOCATED ON THE ATMEL WEBSITE, ATMEL ASSUMES NO LIABILITY WHATSOEVER AND DISCLAIMS ANY EXPRESS, IMPLIED OR STATUTORY WARRANTY RELATING TO ITS PRODUCTS INCLUDING, BUT NOT LIMITED TO, THE IMPLIED WARRANTY OF MERCHANTABILITY, FITNESS FOR A PARTICULAR PURPOSE, OR NON-INFRINGEMENT. IN NO EVENT SHALL ATMEL BE LIABLE FOR ANY DIRECT, INDIRECT, CONSEQUENTIAL, PUNITIVE, SPECIAL OR INCIDENTAL DAMAGES (INCLUDING, WITHOUT LIMITATION, DAMAGES FOR LOSS AND PROFITS, BUSINESS INTERRUPTION, OR LOSS OF INFORMATION) ARISING OUT OF THE USE OR INABILITY TO USE THIS DOCUMENT, EVEN IF ATMEL HAS BEEN ADVISED OF THE POSSIBILITY OF SUCH DAMAGES. Atmel makes no representations or warranties with respect to the accuracy or completeness of the contents of this document and reserves the right to make changes to specifications and products descriptions at any time without notice. Atmel does not make any commitment to update the information contained herein. Unless specifically provided otherwise, Atmel products are not suitable for, and shall not be used in, automotive applications. Atmel products are not intended, authorized, or warranted for use as components in applications intended to support or sustain life.