

JU1215 炬

18V/10W Series



Introduction

Everlight's JU1215 18V/10W Series is a ceramic substrate based LED achieving high efficiency while maintaining high CRI at Energy Star / ANSI color temperature ranges.

Features

- ◆ LM-80 Certified
- ◆ High Power COB & High CRI LED
- ◆ Multi-Chip Solution
- ◆ Dimension: 12 mm x 15 mm x 1.6 mm
- ◆ Main Parameters: Luminous Flux, Forward Voltage, Chromaticity and Color Rendering Index
- ◆ RoHS compliant
- ◆ Energy Star / ANSI Compliant Binning Structure
- ◆ Typical Viewing Angle: 115°

Applications

- ◆ Replacement Bulb
- ◆ Indoor General Lighting
- ◆ Recessed Can Lighting

Table of Contents

Table of Contents.....	2
Product Nomenclature	3
Absolute Maximum Ratings	4
PN of the JU1215 18V/10W series:White LEDs.....	5
Product Binning:Luminous Flux Bins	6
Product Binning:White Bin Structure	7
Product Binning:Warm White Bin Structure	8
Product Binning:Warm White Bin Coordinates.....	8
Product Binning:Neutral White Bin Structure	9
Product Binning:Neutral White Bin Coordinates	9
Product Binning:Cool White Bin Structure.....	10
Product Binning:Cool White Bin Coordinates.....	11
Product Binning:Forward Voltage Bins	12
Mechanical Dimension	13
Pad Configuration.....	14
Typical Electro-Optical Characteristic Curve	15
Product Labeling	20
Carrier Tray Specification	20
Precautions of Use	22
LM-80 test report.....	24
Lumen Maintenance Life Projection	28
Revision History	29

Product Nomenclature

The product name is designated as below:

JU1215-CDEFGHJ-KLMNP-QRST

Family name

JU1215

Designation:

CD = lighting color and wavelength_[1]

EF = color bin or CCT bin

G = internal code

HJ = min. luminous flux (lm) or radiation power (mW) performance

KL = forward voltage bin_[2]

M = internal code

NP = power consumption_[3]

Q= internal code

R= Dam Diameter_[4]

S= internal code

T=Type of Package_[5]

Notes

1. Table of lighting color and wavelength

Symbol	Color	CCT range	Color Rendering Index
GT	Cool-White	4745~7050K	>65
KT	Cool-White	4745~7050K	>80
LM	Warm-White	2580~3710K	>70
	Neutral-White	3710K-4745K	
KM	Warm White	2580~3710K	>80
	Neutral-White	3710K-4745K	

2. Table of forward voltage bin

Symbol	Description
18	18V Input Voltage

3. Power consumption:

Symbol	Description
10	10W

4. Dam Diameter:

Symbol	Description
A	10.0-10.9mm

5. Table of packaging types:

Symbol	Description
T	Tray

Absolute Maximum Ratings

Parameter	Symbol	Ratings	Unit
Max. DC Forward Current (mA)	I_F	800 _[1]	mA
Max. Peak Pulse Current (mA)	I_{Pulse}	900 _[2]	mA
Power Dissipation	P_d	10	W
Thermal Resistance(junction to board)	R_{th}	2.2	°C/W
Max. Junction Temperature	T_J	115	°C
Operating Temperature	T_{Opr}	-40 ~ +85	°C
Storage Temperature	T_{Stg}	-40 ~ +85	°C

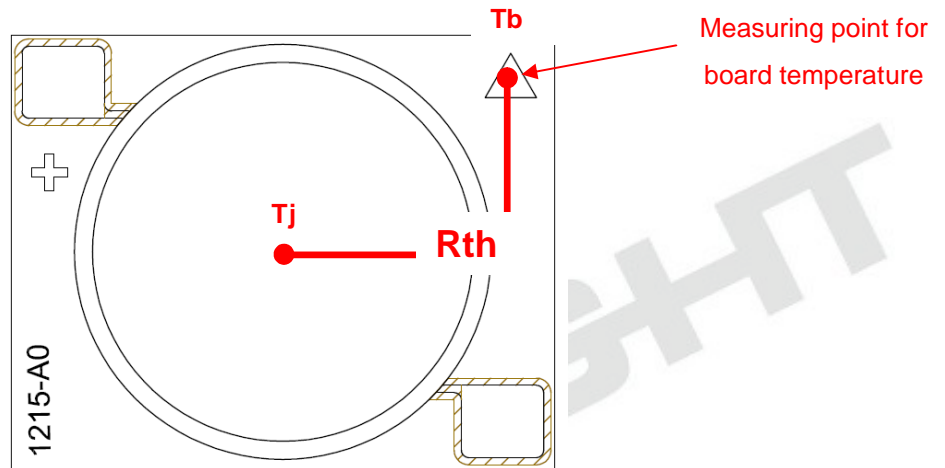

Notes:

1. For optimal performance, Everlight recommends 550mA operation.
2. t_p 100ms, Duty cycle = 25%
3. The JU1215 18V/10W series LEDs are not designed for reverse bias use.

PN of the JU1215 18V/10W series: White LEDs



Order Code of JU1215	Minimum Luminous Flux (lm) @T _j =25°C	Typical Luminous Flux (lm) @T _j =25°C	Typical Luminous Flux (lm) @T _j =85°C	CCT (K)	Forward Voltage (V)	Forward Current (mA)	CRI (min)
JU1215-KM277P1-18610-0A0T	900	1065	978	27K-1~27K-4	16.0~20.0	550	80
JU1215-KM307P2-18610-0A0T	1000	1110	1019	30K-1~30K-4	16.0~20.0	550	80
JU1215-KM407P2-18610-0A0T	1000	1155	1061	40K-1~40K-4	16.0~20.0	550	80
JU1215-KT507P3-18610-0A0T	1100	1210	1114	50K-1~50K-4	16.0~20.0	550	80
JU1215-KT577P3-18610-0A0T	1100	1210	1114	57K-1~57K-4	16.0~20.0	550	80
JU1215-KT657P3-18610-0A0T	1100	1210	1114	65K-1~65K-4	16.0~20.0	550	80

Notes:

1. CRI measurement tolerance: ±2.
2. Luminous flux measurement tolerance: ±10%.
3. The values of luminous flux @ T_j=85°C are calculated and for reference only.
4. Typical luminous flux or light output performance is operated within the condition guided by this datasheet.

Product Binning

Luminous Flux Bins

Group	Bin	Minimum Photometric Flux (lm)	Maximum Photometric Flux (lm)
E	1	4	5
	2	5	6
	3	6	8
	4	8	10
	5	10	13
	6	13	17
	7	17	20
	8	20	23
	9	23	27
F	1	27	33
	2	33	39
	3	39	45
	4	45	52
	5	52	60
	6	60	70
	7	70	80
	8	80	90
	9	90	100

Group	Bin	Minimum Photometric Flux (lm)	Maximum Photometric Flux (lm)
J	1	100	110
	2	110	120
	3	120	130
	4	130	140
	5	140	150
	6	150	160
	7	160	180
	8	180	200
	9	200	225
K	1	225	250
	2	250	275
	3	275	300
	4	300	325
	5	325	350
	6	350	375
	7	375	400
	8	400	425
	9	425	450
N	1	450	475
	2	475	500
	3	500	550
	4	550	600
	5	600	650
	6	650	700
	7	700	750
	8	750	800
	9	800	900
P	1	900	1000
	2	1000	1100
	3	1100	1200
	4	1200	1350
	5	1350	1500
	6	1500	1650

White Bin Structure

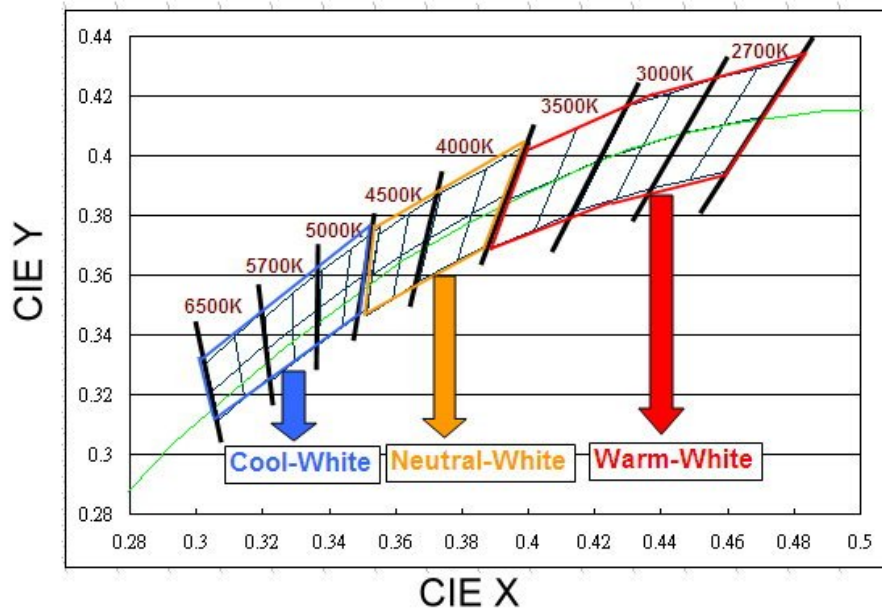

Chromaticity specification defined by ANSI

Notes:

1. The CCT range of Cool-White varies from 4745K to 7050K.
2. The CCT range of Neutral-White varies from 3710K to 4745K.
3. The CCT range of Warm-White varies from 2580K to 3710K
4. Color coordinates measurement allowance : ± 0.01
5. Color bins are defined at $I_f=550\text{mA}$ operation

Warm-White Bin Structure

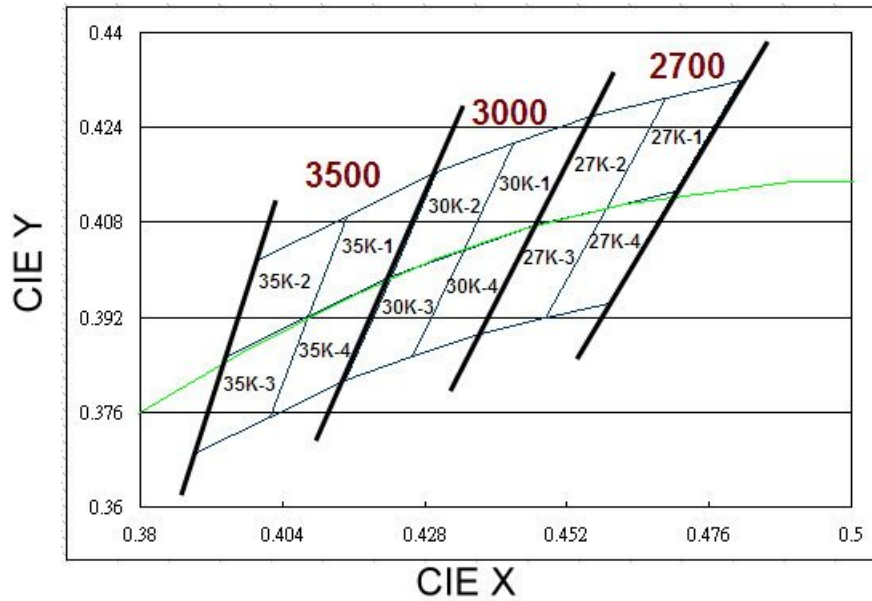

Warm-White Bin Coordinates

2700K

Bin	CIE X	CIE Y
27K-1	0.469	0.429
	0.459	0.410
	0.470	0.413
	0.481	0.432
Reference Range: 2580~2700K		

Bin	CIE X	CIE Y
27K-2	0.456	0.426
	0.447	0.408
	0.459	0.410
	0.469	0.429
Reference Range: 2700~2870K		

Bin	CIE X	CIE Y
27K-4	0.459	0.410
	0.448	0.392
	0.459	0.394
	0.470	0.413
Reference Range: 2580~2700K		

Bin	CIE X	CIE Y
27K-3	0.447	0.408
	0.437	0.389
	0.448	0.392
	0.459	0.410
Reference Range: 2700~2870K		

3000K

Bin	CIE X	CIE Y
30K-1	0.443	0.421
	0.435	0.403
	0.447	0.408
	0.456	0.426
Reference Range: 2870~3000K		

Bin	CIE X	CIE Y
30K-2	0.430	0.417
	0.422	0.399
	0.435	0.403
	0.443	0.421
Reference Range: 3000~3220K		

Bin	CIE X	CIE Y
30K-4	0.435	0.403
	0.426	0.385
	0.437	0.389
	0.447	0.408
Reference Range: 2870~3000K		

Bin	CIE X	CIE Y
30K-3	0.422	0.399
	0.415	0.381
	0.426	0.385
	0.435	0.403
Reference Range: 3000~3220K		

Notes:

- Color coordinates measurement allowance : ±0.01.

Neutral-White Bin Structure

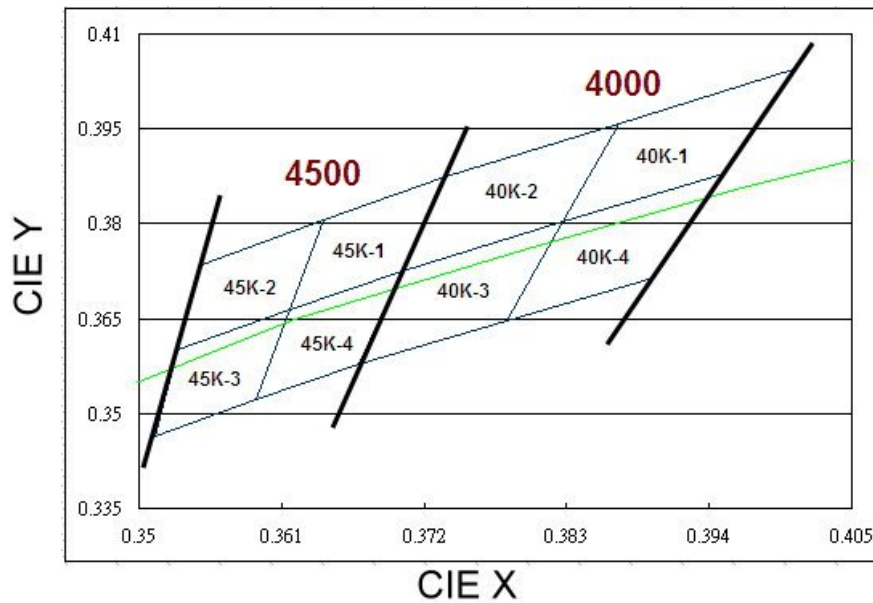

Neutral-White Bin Coordinates

4000K

Bin	CIE X	CIE Y
40K-1	0.387	0.396
	0.383	0.380
	0.395	0.388
	0.401	0.404
Reference Range: 3710~4000K		

Bin	CIE X	CIE Y
40K-2	0.374	0.387
	0.370	0.373
	0.383	0.380
	0.387	0.396
Reference Range: 4000~4260K		

Bin	CIE X	CIE Y
40K-4	0.383	0.380
	0.378	0.365
	0.390	0.372
	0.395	0.388
Reference Range: 3710~4000K		

Bin	CIE X	CIE Y
40K-3	0.370	0.373
	0.367	0.358
	0.378	0.365
	0.383	0.380
Reference Range: 4000~4260K		

Notes:

1. Color coordinates measurement allowance : ± 0.01 .

Cool-White Bin Structure

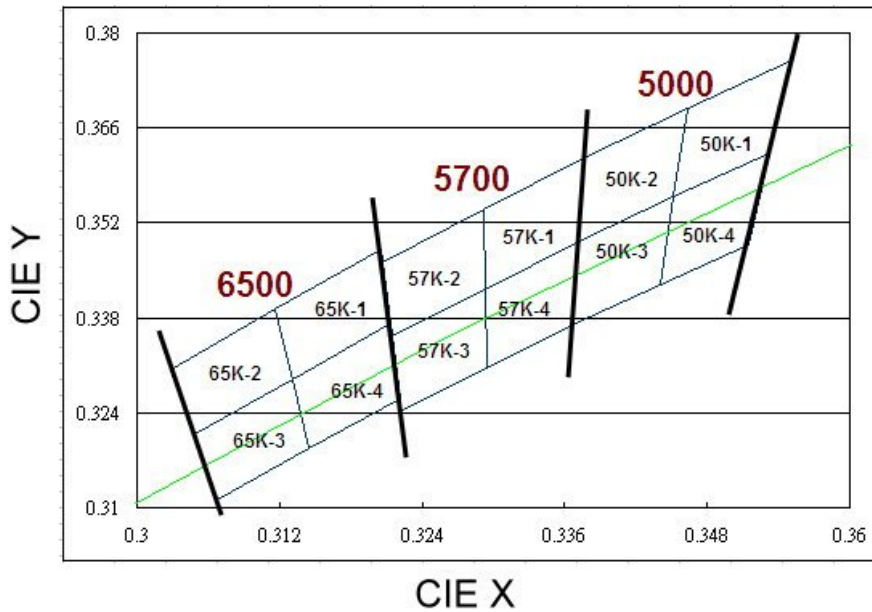

Cool-White Bin Coordinates

5000K

Bin	CIE X	CIE Y
50K-1	0.346	0.369
	0.345	0.356
	0.353	0.362
	0.355	0.376
Reference Range: 4745~5000K		

Bin	CIE X	CIE Y
50K-2	0.338	0.362
	0.337	0.349
	0.345	0.356
	0.346	0.369
Reference Range: 5000~5310K		

Bin	CIE X	CIE Y
50K-4	0.345	0.356
	0.344	0.343
	0.352	0.349
	0.353	0.362
Reference Range: 4745~5000K		

Bin	CIE X	CIE Y
50K-3	0.337	0.349
	0.337	0.337
	0.344	0.343
	0.345	0.356
Reference Range: 5000~5310K		

5700K

Bin	CIE X	CIE Y
57K-1	0.329	0.354
	0.329	0.342
	0.337	0.349
	0.338	0.362
Reference Range: 5310~5700K		

Bin	CIE X	CIE Y
57K-2	0.321	0.346
	0.322	0.335
	0.329	0.342
	0.329	0.354
Reference Range: 5700~6020K		

Bin	CIE X	CIE Y
57K-4	0.329	0.342
	0.329	0.331
	0.337	0.337
	0.337	0.349
Reference Range: 5310~5700K		

Bin	CIE X	CIE Y
57K-3	0.322	0.335
	0.322	0.324
	0.329	0.331
	0.329	0.342
Reference Range: 5700~6020K		

6500K

Bin	CIE X	CIE Y
65K-1	0.312	0.339
	0.313	0.329
	0.321	0.337
	0.321	0.348
Reference Range: 6020~6500K		

Bin	CIE X	CIE Y
65K-2	0.303	0.330
	0.305	0.321
	0.313	0.329
	0.312	0.339
Reference Range: 6500~7050K		

Bin	CIE X	CIE Y
65K-4	0.313	0.329
	0.315	0.319
	0.322	0.326
	0.321	0.337
Reference Range: 6020~6500K		

Bin	CIE X	CIE Y
65K-3	0.305	0.321
	0.307	0.311
	0.315	0.319
	0.313	0.329
Reference Range: 6500~7050K		

Notes:

1. Color coordinates measurement allowance : ± 0.01

EVERLIGHT

Forward Voltage Bins

Bin	Minimum Forward Voltage (V)	Maximum Forward Voltage (V)
R8	16.0	17.0
R9	17.0	18.0
T1	18.0	19.0
T2	19.0	20.0

Notes:

1. Forward voltage measurement tolerance: $\pm 2\%$.
2. Forward voltage bins are defined at $I_f=550\text{mA}$ operation.
3. Other Forward Voltage bins for White LEDs available upon request. Please contact your local Everlight sales office.

EVERLIGHT

Mechanical Dimension

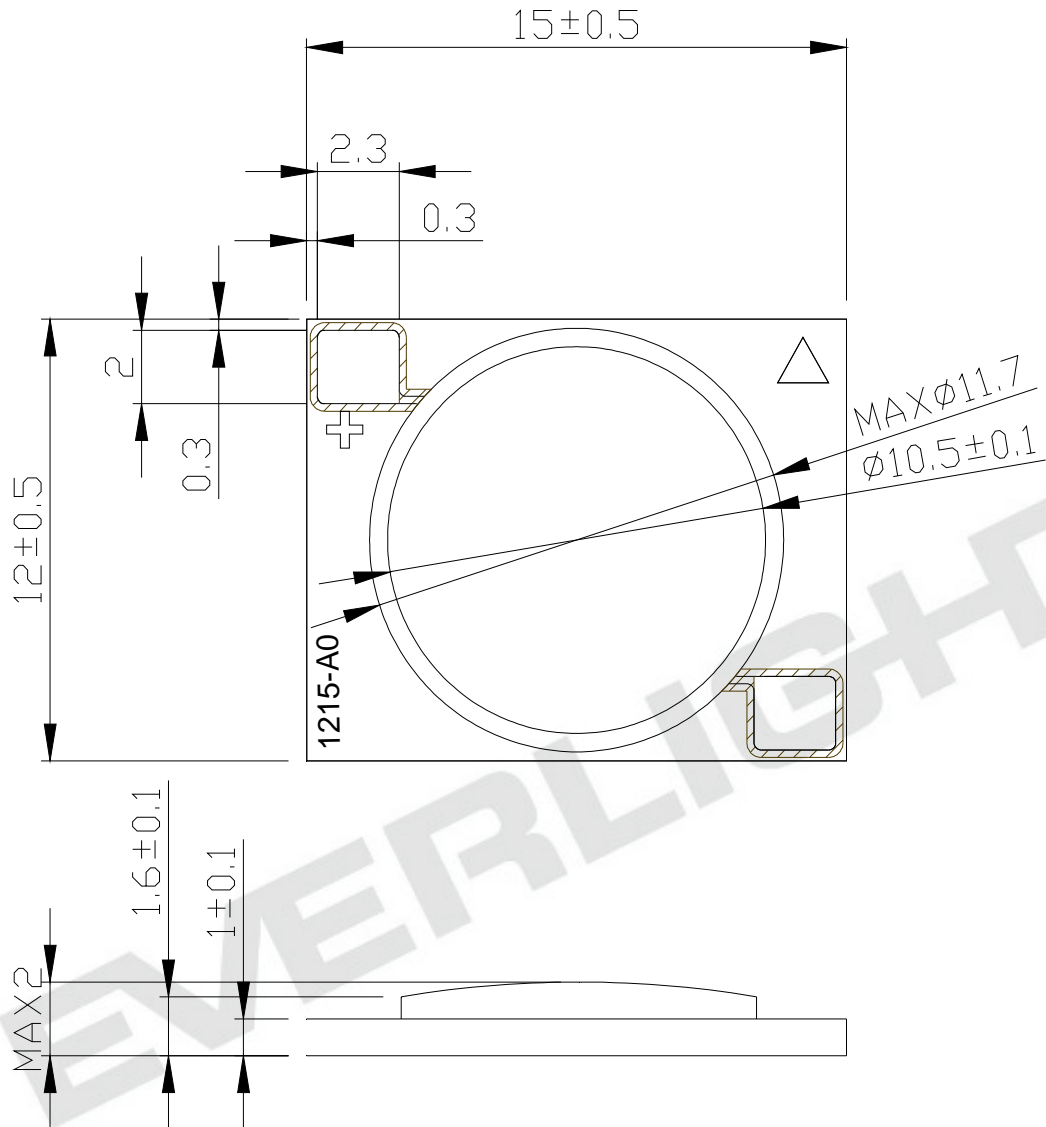

➔ ... ➔ 6 series × 6 parallel

Note:

1. Dimensions are in millimeters.
2. Tolerances : ± 0.1 mm.

Pad Configuration

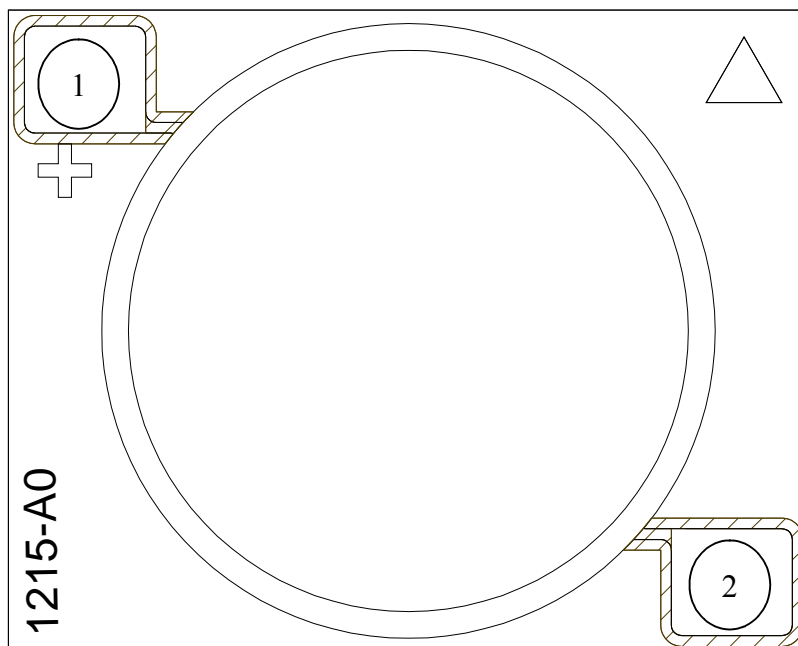

PAD	FUNCTION
1	ANODE
2	CATHODE

Typical Electro-Optical Characteristic Curve

Relative Spectral Distribution
@ Substrate Temperature = 25

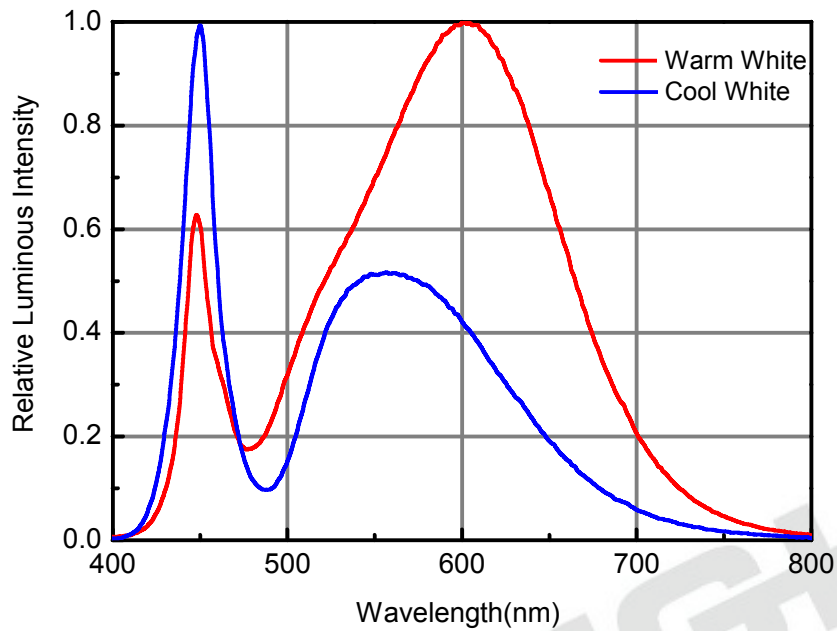

Relative Luminous Flux vs. Substrate Temperature
@ Forward Current = 550mA

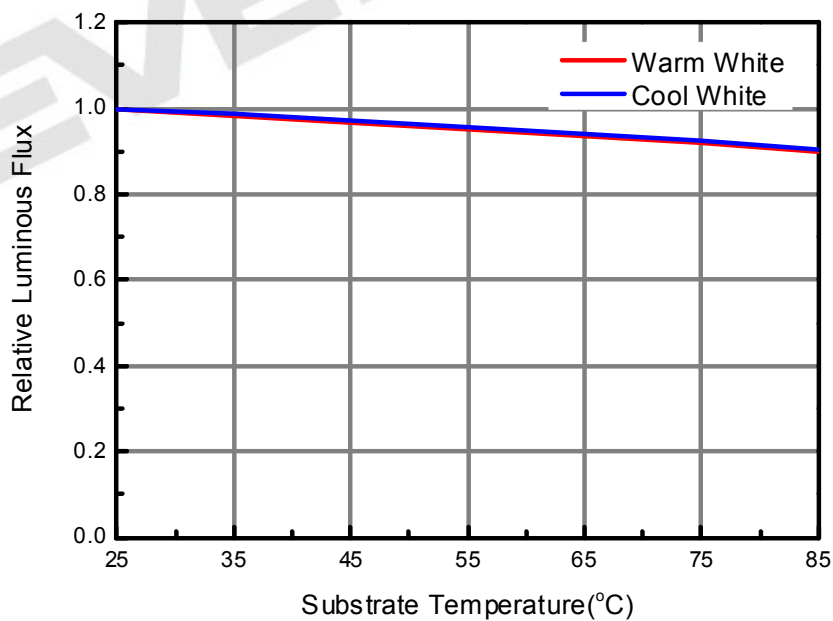

Forward Voltage vs. Forward Current @ Substrate Temperature = 25

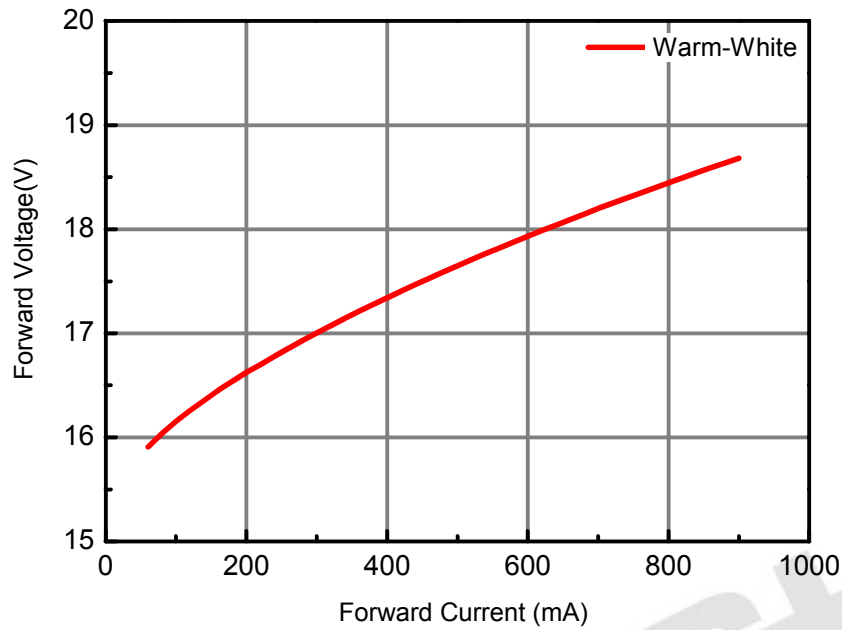

Relative Luminous Flux vs. Forward Current @ Substrate Temperature = 25

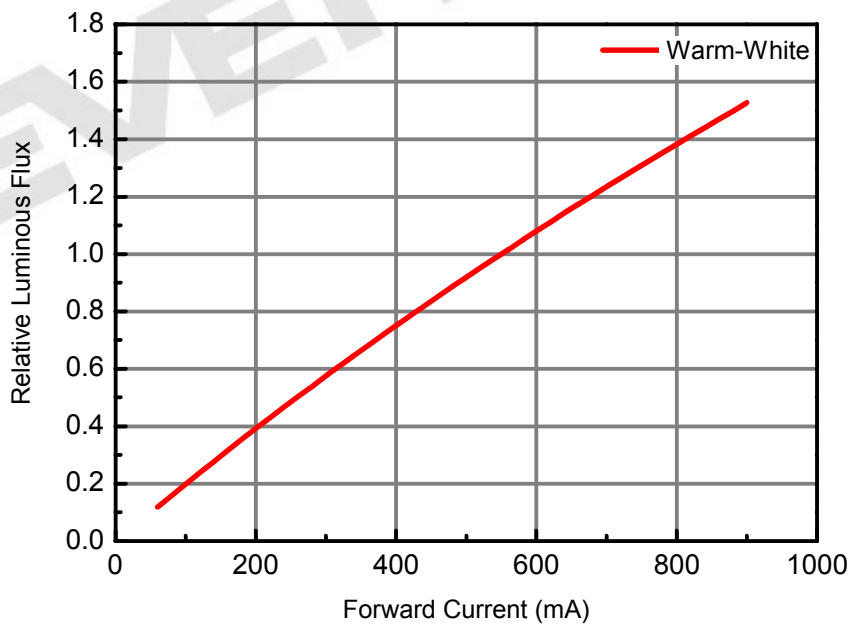

Correlated Color Temperature vs. Forward Current @ Substrate Temperature = 25

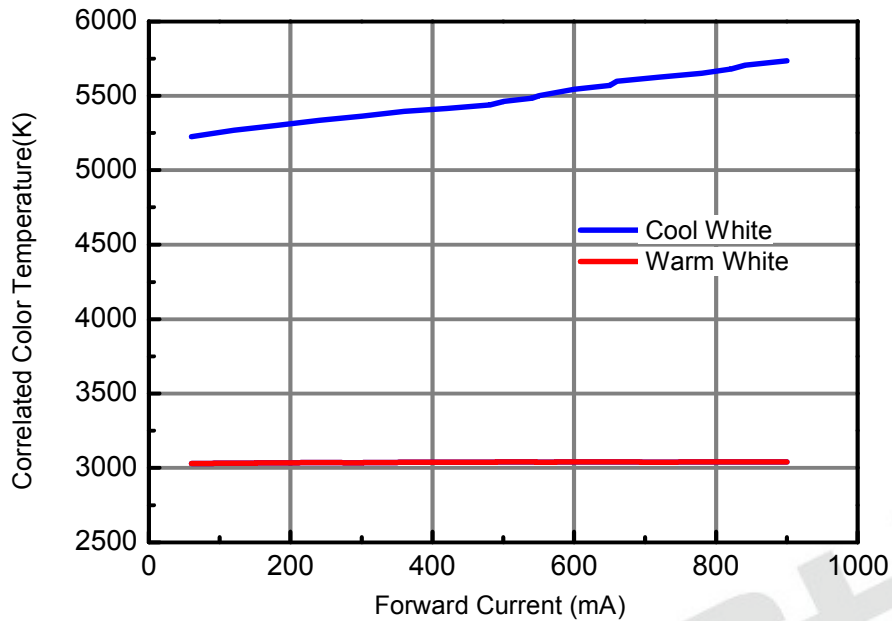

Correlated Color Temperature vs. Substrate Temperature @ Forward Current = 550mA

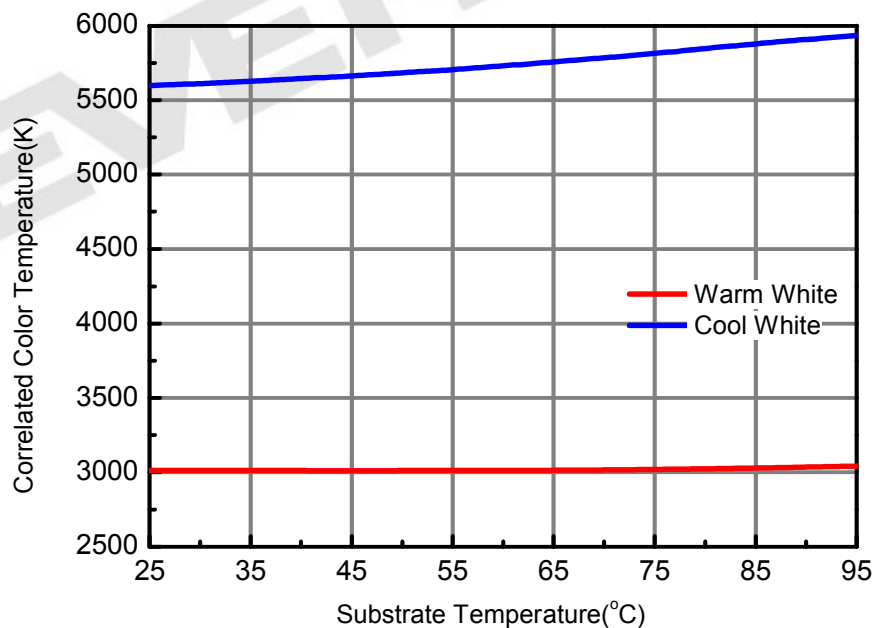

Forward Voltage vs. Substrate Temperature
@ Forward Current = 550mA

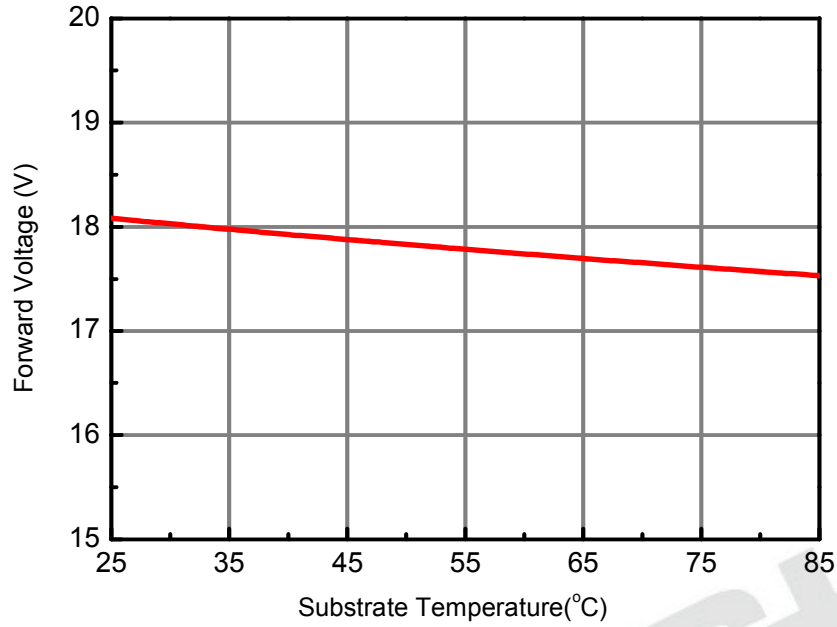

Forward Current Derating Curve
@ Junction Temperature <115

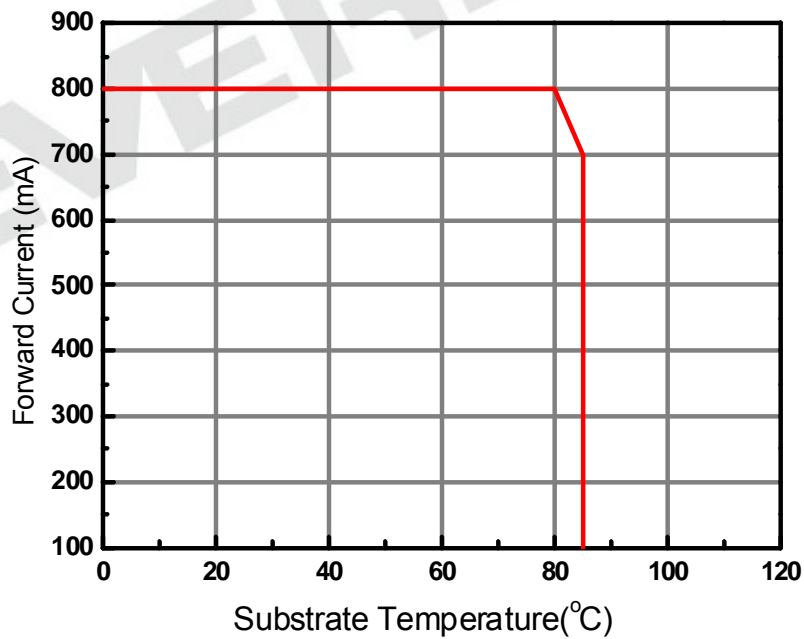

Typical Diagram Characteristics of Radiation Patterns

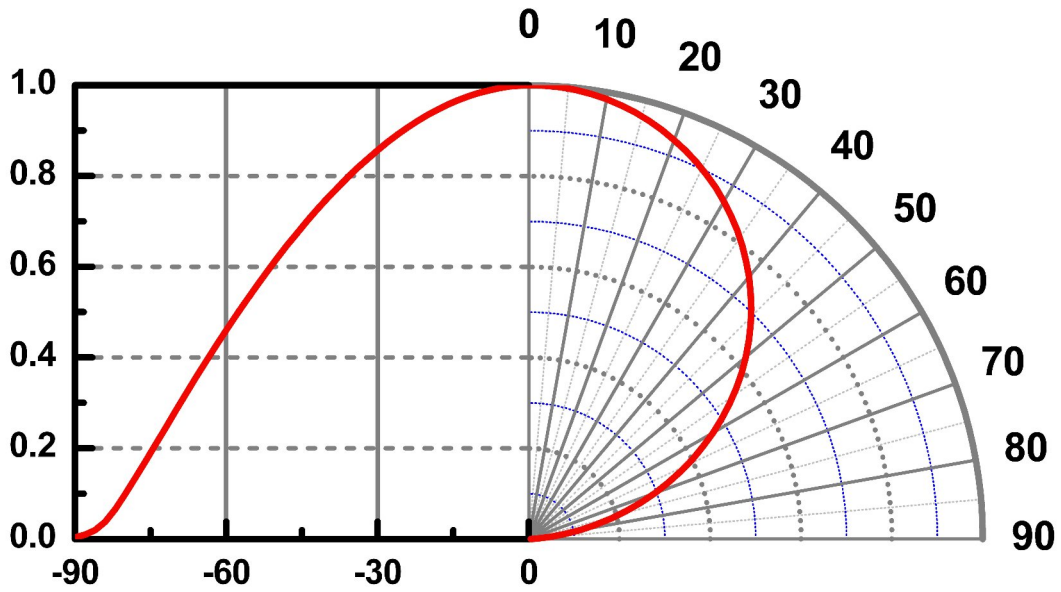

Notes:

1. $2\theta_{1/2}$ is the off axis angle from lamp centerline where the luminous intensity is 1/2 of the peak value.
2. Viewing angle tolerance is $\pm 5^\circ$.

Product Labeling

Label Explanation

- CPN: Customer Specification (when required)
- P/N : Everlight Production Number
- QTY: Packing Quantity
- CAT: Luminous Flux (Brightness) Bin
- HUE: Color Bin
- REF: Forward Voltage Bin
- LOT No: Lot Number
- MADE IN TAIWAN: Production Place



Carrier Tray Specification

Loaded Quantity: 100 PCS Per Tray

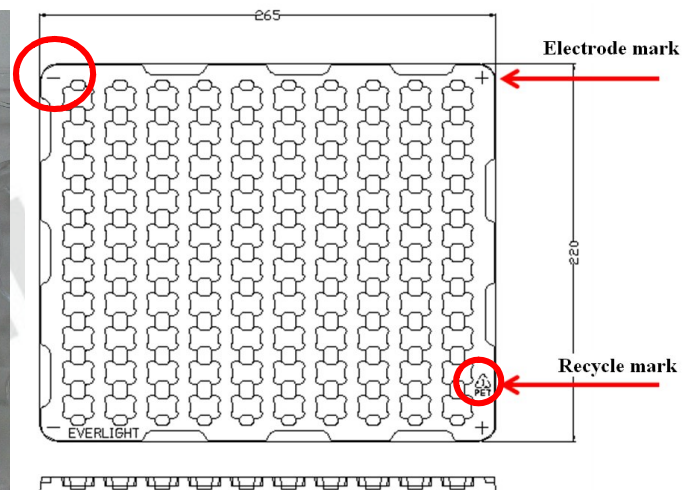

Notes:

1. Dimensions are in millimeters.
2. Tolerances unless mentioned are $\pm 0.1\text{mm}$

LED Direction

- The **Recycle mark** on the LEDs will be toward the **Anode mark** on the carrier tray.

Moisture Resistant Packaging



Outside Carton

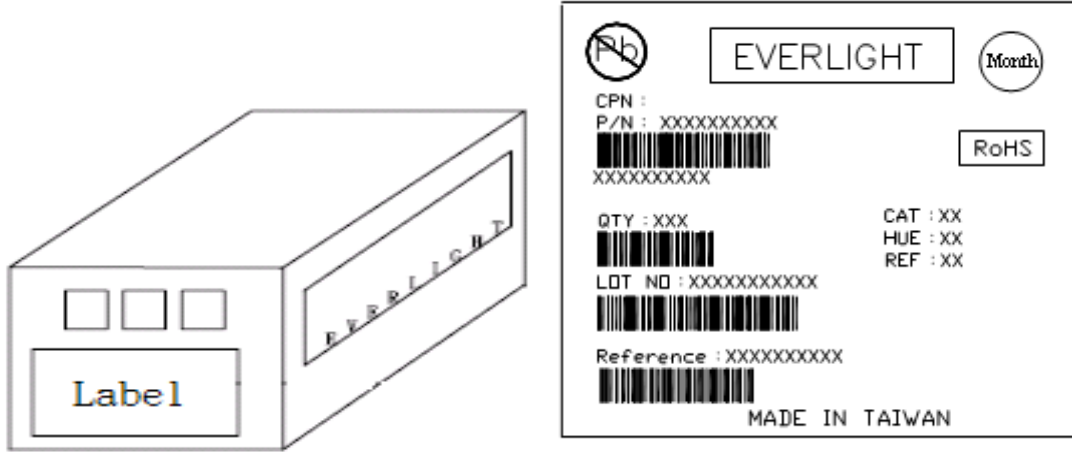

Packaging Quantity

- 100 PCS Per Tray
- 10 Trays Per Outside Carton

EVERLIGHT

Precautions of Use

Over-Current-Proof

- Though the JU1215 has a conducted ESD protection mechanism, customers must not use the device in reverse and should apply resistors for extra protection. Otherwise slight voltage shift may cause significant current changes and burn out failure may happen.

Storage Conditions

- Before the package is opened: The LEDs should be stored at 30°C or less and 50%RH or less after being shipped from Everlight and the storage life limit is 6 months. If the LEDs are stored for 6 months or more, they should be stored in a sealed container with a nitrogen atmosphere and moisture absorbent material.
- After opening the package: The LED should be stored under 30°C or less and 30%RH or less. The LED should be used within 168hrs (7days) after opening the package. If unused LEDs remain, it should be stored in moisture proof packages.
- Do not stack assemblies.

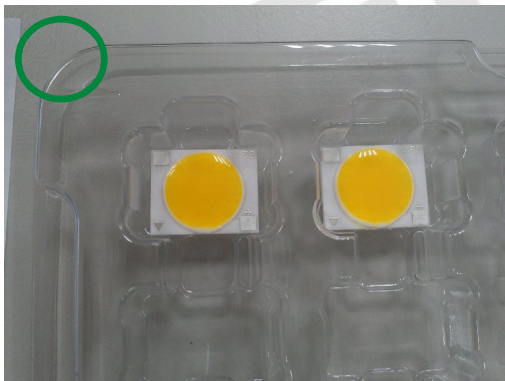

Handling

- Do not put mechanical stress on the LED.
- Never touch the optical surface with finger or sharp object. The LED surface could be soiled or damaged, which could affect the optical performance of the LED.
- In low-humidity work environment, please keep handling the LEDs with appropriate ESD grounding.
- It is recommended to handle the LED with powder-less latex gloves.

Manual Handling

- When handling the product, do not apply direct pressure on the optical surface.
- Do not touch the resin with tweezers to avoid scratching or other damage.

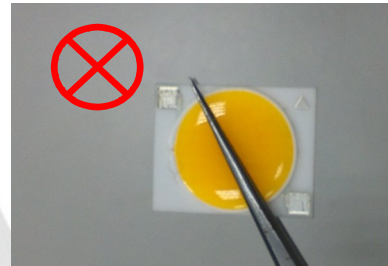
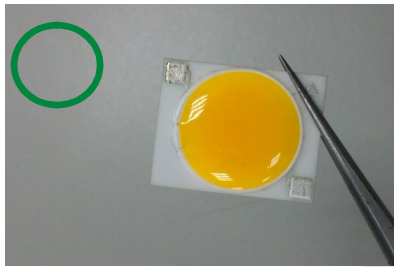

Thermal Management

- Sufficient thermal management must be implemented. Substrate of the positive in temperature must be kept under 105°C at the driving current of 550mA. Otherwise, the junction temperature of die may exceed the limit at high current driving conditions and the LEDs' lifetime may be decrease dramatically.

LM-80 Test Report



Report No.: OA-2012-90025

Page 1 of 40

Issued: Jun. 25, 2013

TEST REPORT

The following tested product(s) were submitted and identified by the vendor as:

Applicant : EVERLIGHT ELECTRONICS CO., LTD.
Address of Applicant : No.6-8, Zhonghua Rd., Shulin Dist, New Taipei City
23860, Taiwan, R.O.C.
Testing Laboratory : SGS Taiwan Ltd., Optics Laboratory
Laboratory Address : 33, Wu Chyuan Rd., New Taipei Industrial Park, New
Taipei City, Taiwan 24886
Product Name : LED Component JU1215 18 V / 10 W COB Series
Model / Serial Number : JU1215-KM307P2-18610-0A0T
Manufacturer : EVERLIGHT ELECTRONICS CO., LTD.
Rating : DC 550 mA, 16 V to 20 V
Tested Condition : DC 720 mA (Constant Current)
Test Standard/Method : IES LM-80-08 Approved Method: Measuring Lumen
Maintenance of LED Light Sources
Date of Issue : Jun. 25, 2013

The submitted products have been tested as requested and the following results were obtained, and the report, not applicable for lawsuit, refers only to the unit(s) submitted for test.

Test Results : -PLEASE SEE ATTACHED SHEETS-

Signed for and on behalf of
SGS TAIWAN Ltd.

Calvin Tzou
Technical Manager

Unless otherwise stated the results shown in this test report refer only to the sample(s) tested. This test report cannot be reproduced, except in full, without prior written permission of the Company. 除非另有說明，此報告中呈現之測試結果僅針對本公司所管轄之樣品，不可擅自複製。
This document is issued by the Company subject to its General Conditions of Service printed overleaf, available on request or accessible at www.sgs.com/terms_and_conditions.htm and, for electronic format documents, subject to Terms and Conditions for Electronic Documents at www.sgs.com/terms_and_conditions/terms_e-document. Attention is drawn to the limitation of liability, indemnification and jurisdiction issues defined therein. Any holder of this document is advised that information contained herein reflects the Company's findings at the time of its intervention only and within the limits of Client's instructions, if any. The Company's sole responsibility is to its Client and this document does not exonerate parties to a transaction from exercising all their rights and obligations under the transaction documents. This document cannot be reproduced except in full, without prior written approval of the Company. Any unauthorized alteration, forgery or falsification of the content or appearance of this document is unlawful and offenders may be prosecuted to the fullest extent of the law.



Report No.: OA-2012-90025

Page 2 of 40

Issued: Jun. 25, 2013

1 SAMPLING DESCRIPTION

No sampling action and method employed

2 DATE OF RECEIPT OF SAMPLES

Sep. 24, 2012

3 DATE(S) OF PERFORMANCE OF THE TEST

Sep. 24, 2012 ~ Jun 17, 2013

4 IDENTITY OF SAMPLES

Quantity	Model	Serial Number
25	JU1215-KM307P2-18610-0ADT	# A01 - # A25 (55 °C)
25	JU1215-KM307P2-18610-0ADT	# B01 - # B25 (85 °C)
25	JU1215-KM307P2-18610-0ADT	# C01 - # C25 (95 °C)

5 TEST ITEMS

5.1 Data Summary of Lumen and Color Maintenance

Test results were concluded by different Case Temperatures (Ts).

5.2 Lumen Maintenance and Color Maintenance Test

Testing specifications by different case temperatures according to IES LM-80-08 Approved Method: Measuring Lumen Maintenance of LED Light Sources and client's requirements were Implemented per the following items.

5.2.1 Total Luminous Flux (Φ_v)

The test results of total luminous flux were implemented referring to Clause 2 PROPERTIES OF LEDS & Clause 6 MEASUREMENT OF LUMINOUS FLUX of CIE 127: 2007 2nd edition MEASUREMENT OF LEDS and IES LM-80-08 Approved Method: Measuring Lumen Maintenance of LED Light Sources, when the UUTs were powered with constant current of I.

5.2.2 Correlated Color Temperature (CCT), CIE Color Coordinate (CIE_x, CIE_y) & Chromaticity Shift ($\Delta u'v'$)

The test results of correlated color temperature were implemented referring to CIE 127:2007 2nd edition MEASUREMENT OF LEDS, CIE 15: 2004 COLORIMETRY.

The test results of color coordinate were implemented referring to CIE 127: 2007 2nd edition MEASUREMENT OF LEDS, CIE 15:2004 COLORIMETRY.

Unless otherwise stated the results shown in this test report refer only to the sample(s) tested. This test report cannot be reproduced, except in full, without prior written permission of the Company. 除非另有說明，此報告結果僅針對測試之產品與量測。本報告中所有內容均受版權保護，不可擅自複製。
This document is issued by the Company subject to its General Conditions of Service printed overleaf, available on request or accessible at www.sgs.com/terms_and_conditions.htm and, for electronic format documents, subject to Terms and Conditions for Electronic Documents at www.sgs.com/en/Terms-and-Conditions/Terms-e-Documents. Attention is drawn to the limitation of liability, indemnification and jurisdiction issues defined therein. Any holder of this document is advised that information contained hereon reflects the Company's findings at the time of its intervention only and within the limits of Client's instructions, if any. The Company's sole responsibility is to its Client and this document does not exonerate parties to a transaction from exercising all their rights and obligations under the transaction documents. This document cannot be reproduced except in full, without prior written approval of the Company. Any unauthorized alteration, forgery or falsification of the content or appearance of this document is unlawful and offenders may be prosecuted to the fullest extent of the law.



Report No.: OA-2012-90025

Page 3 of 40

Issued: Jun. 25, 2013

6 TEST CONDITIONS

Main Test Equipment:

Name	Brand	Model	S/N	Traceability
Standard Light Source / Spectroradiometer	Labsphere	SCL-600 / CDS 2100	D112 / 0811118355	NIST
Source Meter	Kethley	2400	1321218	NMI
Handheld Digital Multimeter	Agilent	U1242A	MY48490144	NMI

Environmental Conditions:

Temperature: (25 ± 1) °C
Relative Humidity: < 65 % RH

LUJ Conditions:

LED Light source: LED Package
Drive Current: DC 720 mA (Over spec., Define by Client)
Forward Voltage: DC 18 V (Typical)
Power Consumption: 10 W
CCT: 3000 K
Package Dimension: L 12 mm x W 15 mm x H 1.6 mm
Prior operation: 0 hour
Total Operation Duration: 6000 hours
Target CCT: 3000 K
Sample Size: 75 pcs (25 pcs for each temperature)
Failed Quantity: 0 pcs

Measurement Conditions:

Interval Time: 0, 1000, 2000, 3000, 4000, 5000, 6000 hours
Warm up Time: < 1 minute (Initial)
Relative measurement uncertainty: 2.8 % (95 % Confidence Level)

Unless otherwise stated the results shown in this test report refer only to the sample(s) tested. This test report cannot be reproduced, except in full, without prior written permission of the Company. 除非另有說明，此報告結果僅針對測試之樣品負責。本報告中除本公司商標外，不可擅自複製。
This document is issued by the Company subject to its General Conditions of Service printed overleaf, available on request or accessible at www.sgs.com/terms_and_conditions.htm and, for electronic format documents, subject to Terms and Conditions for Electronic Documents at www.sgs.com/en/Terms-and-Conditions/Terms-e-Documents. Attention is drawn to the limitation of liability, indemnification and jurisdiction issues defined therein. Any holder of this document is advised that information contained hereon reflects the Company's findings at the time of its intervention only and within the limits of Client's instructions, if any. The Company's sole responsibility is to its Client and this document does not exonerate parties to a transaction from exercising all their rights and obligations under the transaction documents. This document cannot be reproduced except in full, without prior written approval of the Company. Any unauthorized alteration, forgery or falsification of the content or appearance of this document is unlawful and offenders may be prosecuted to the fullest extent of the law.

SGS Taiwan Ltd. 33, Wu Chuan Road, Wu Ku District, New Taipei City, Taiwan (新北市五股區五權路 33 號)
台灣檢驗科技股份有限公司 t (086-2) 2299-3232 f (086-2) 2298-3255 www.sgs.tw
Member of SGS Group



Report No.: OA-2012-90025

Page 4 of 40

Issued: Jun. 25, 2013

7 TEST RESULTS

7.1 Data Summary of Lumen and Color Maintenance

Temp.	Initial (0 hr)		Luminous Maintenance (%)					
	TLF(lm)	$V_f(V)$	1000 hrs	2000 hrs	3000 hrs	4000 hrs	5000 hrs	6000 hrs
55°C Avg.	1307.68	19.05	99.6 %	99.0 %	98.8 %	97.8 %	96.4 %	94.4 %
85°C Avg.	1313.32	19.10	99.4 %	98.7 %	98.2 %	97.6 %	96.2 %	94.0 %
95°C Avg.	1320.80	19.06	99.3 %	98.4 %	97.4 %	96.3 %	94.6 %	92.2 %

Temp.	Initial (0 hr)			Chromaticity Shift ($\Delta u'v'$)					
	CIEx	CIEy	CCT	1000 hrs	2000 hrs	3000 hrs	4000 hrs	5000 hrs	6000 hrs
55°C Avg.	0.4292	0.4060	3148.2	0.0002	0.0004	0.0003	0.0004	0.0006	0.0009
85°C Avg.	0.4298	0.4067	3142.8	0.0003	0.0003	0.0003	0.0004	0.0006	0.0008
95°C Avg.	0.4297	0.4066	3143.8	0.0002	0.0003	0.0002	0.0004	0.0006	0.0009

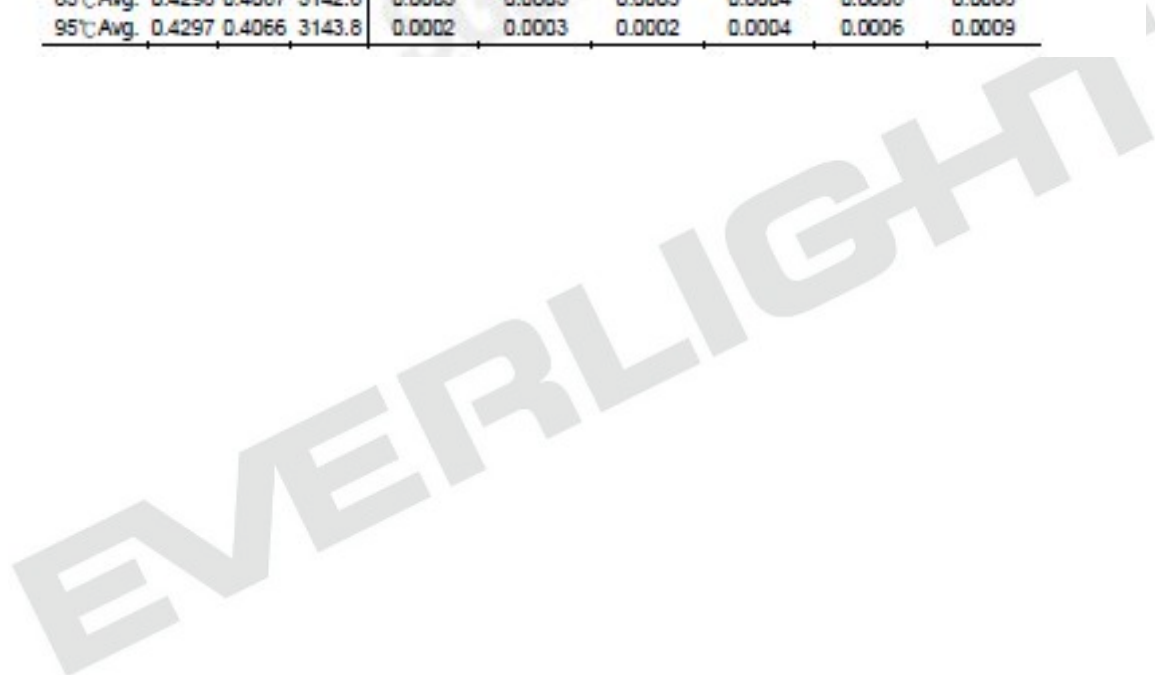

Lumen Maintenance Life Projection

Table 1: Report at each LM-80 Test Condition

Description of LED Light Source Tested (manufacturer, model, catalog number)		Test Condition 1 - 55°C Case Temp		Test Condition 2 - 85°C Case Temp		Test Condition 3 - 95°C Case Temp	
Sample size	25	Sample size	25	Sample size	25	Sample size	25
Number of failures	0	Number of failures	0	Number of failures	0	Number of failures	0
DUT drive current used in the test (mA)	720	DUT drive current used in the test (mA)	720	DUT drive current used in the test (mA)	720	DUT drive current used in the test (mA)	720
Test duration (hours)	6,000	Test duration (hours)	6,000	Test duration (hours)	6,000	Test duration (hours)	6,000
Test duration used for projection (hour to hour)	1,000 - 10,000	Test duration used for projection (hour to hour)	1,000 - 10,000	Test duration used for projection (hour to hour)	1,000 - 10,000	Test duration used for projection (hour to hour)	1,000 - 10,000
Tested case temperature (°C)	55	Tested case temperature (°C)	85	Tested case temperature (°C)	95	Tested case temperature (°C)	95
α	6.177E-06	α	6.660E-06	α	8.418E-06	α	8.418E-06
B	1.001	B	1.000	B	0.997	B	0.997
Calculated L70(9k) (hours)	58,000	Calculated L70(9k) (hours)	54,000	Calculated L70(9k) (hours)	42,000	Calculated L70(9k) (hours)	42,000
Reported L70(9k) (hours)	>36000	Reported L70(9k) (hours)	>36000	Reported L70(9k) (hours)	>36000	Reported L70(9k) (hours)	>36000

Revision History

Current version: 10.03.2013

Issue No: DHE-0002042

Version: 7

Created by: Alun Hu

Page	Subjects (major change in previous version)	Date of change
	Create new – Warm-White & Neutral-White	Dec.11.2012
	Create new – Cool-White	Fub.01.2013
20	Created Moisture Resistant Packaging	May.09.2013
24	Created LM80 test report	July.26.2013
13	Modify mechanical dimensions of image formats	Aug.28.2013
4	Modify Max. DC Forward Current (mA)	Oct.03.2013
28	Change Lumen Maintenance Life Projection	Dec.20.2013