

Multi-Layer Ceramic Chip Inductors

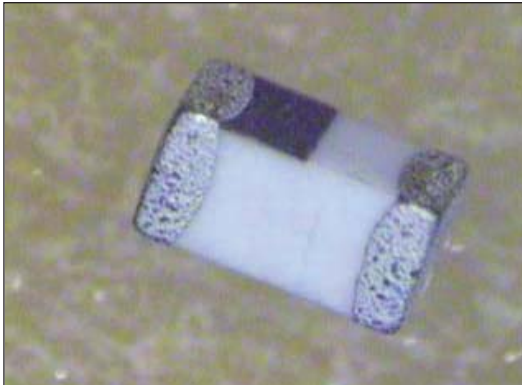

LCMC Series



APPLICATIONS

- High Frequency Applications:
 - Mobile Communications
 - WLAN
 - PHS
 - EMI Counter measure in High Frequency Circuits
 - Computer Communication

FEATURES

- For high frequency applications
- Standard EIA sizes 0201 (0603), 0402 (1005), 0603 (1608)
- Lead-free RoHS compliant parts
- Tight tolerance in physical dimensions
- Surface mounting applicability (Supports reflow soldering condition)
- Tight Inductance Tolerance, Excellent Q and Guaranteed SRF range
- High product quality and outstanding reliability. (Ceramic integrated structure)
- Operating temperature -55°C to +125°C

HOW TO ORDER

| | | | | | | | | |
|--------------------|------------------|----------------------|--|--|--|--------------------|----------------|------------------|
| LC | MC | 0402 | K | 101 | G | T | A | R |
| T | T | T | T | T | T | T | T | T |
| Family | Series | Size | Tolerance | Inductance | Style | Termination | Special | Packaging |
| LC = Chip Inductor | MC = Multi-Layer | 0201 0402 0603 | G = 2% H = 3% J = 5% K = 10% B = 0.1nH C = 0.2nH S = 0.3nH | 3N9 = 3.9nH 39N = 39nH R39 = 390nH | G = Standard Q = High Q/ High Current R = Low Profile | T = Sn Plating | A = Standard | R = 7" Reel |

DIMENSIONS

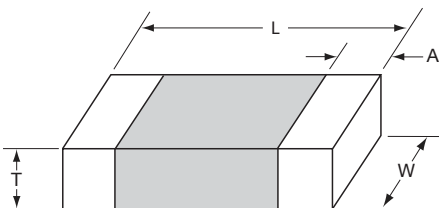

mm (inches)

| Code | L | W | T | A | |
|--------------------|--------------------------------|--------------------------------|--------------------------------|-----------------|-----------------|
| | | | | Min | Max |
| LCMC0201 (0603) | 0.60 ± 0.03 (0.024 ± 0.001) | 0.30 ± 0.03 (0.012 ± 0.001) | 0.30 ± 0.03 (0.012 ± 0.001) | 0.10 (0.004) | 0.20 (0.008) |
| LCMC0402 (1005) | 1.00 ± 0.10 (0.040 ± 0.004) | 0.50 ± 0.10 (0.020 ± 0.004) | 0.50 ± 0.10 (0.020 ± 0.004) | 0.10 (0.004) | 0.30 (0.012) |
| LCMC0603 (1608) | 1.60 ± 0.15 (0.063 ± 0.006) | 0.80 ± 0.15 (0.031 ± 0.006) | 0.80 ± 0.15 (0.031 ± 0.006) | 0.20 (0.008) | 0.60 (0.024) |

AVAILABLE INDUCTANCE VALUE AND TOLERANCE

| Dimension Code (EIA Code) | Available Inductance | Ratings | Normal Tolerance | Available Tolerance on Request |
|---------------------------|----------------------|---------------|------------------|--------------------------------|
| LCMC0201 (0603) | 0.3nH ~ 100nH | 0.3nH ~ 6.2nH | S: ±0.3nH | D: ±0.1nH |
| | | 6.8nH ~ 27nH | J: ±5% | C: ±0.2nH |
| | | 33nH ~ 100nH | | H: ±3% |
| LCMC0402 (1005) | 0.6nH ~ 270nH | 0.6nH ~ 6.2nH | S: ±0.3nH | C: ±0.2nH |
| LCMC0603 (1608) | 1.0nH~ 470nH | 1.0nH ~ 5.6nH | S: ±0.3nH | D: ±0.1nH |
| | | 6.8nH ~ 390nH | J: ±5% | C: ±0.2nH |
| | | | | G: ±2% |



Multi-Layer High Frequency Ceramic Chip Inductors



LCMC Series

ELECTRICAL CHARACTERISTICS

| 0201 | | | | | | | | | | |
|---------------|-----------------|--|--------|--------------------------------|--------------------------------|--------|----------------------------|------|-------------------------|-------------------------------|
| Ordering Code | Inductance (nH) | Available Tolerance | Q Min. | L, Q Measuring Frequency (MHz) | Self-Resonance Frequency (MHz) | | DC Resistance (Ω) | | Rated Current (mA) Max. | Packing Amount of 7" Reel Pcs |
| | | | | | Min. | Typ. | Max. | Typ. | | |
| 0N3 | 0.3 | $\pm 0.3\text{nH}, \pm 0.2\text{nH}, \pm 0.1\text{nH}$ | 4 | 100 | 10,000 | >13000 | 0.07 | 0.03 | 250 | 15000 |
| 0N4 | 0.4 | $\pm 0.3\text{nH}, \pm 0.2\text{nH}, \pm 0.1\text{nH}$ | 4 | 100 | 10,000 | >13000 | 0.07 | 0.04 | 250 | |
| 0N5 | 0.5 | $\pm 0.3\text{nH}, \pm 0.2\text{nH}, \pm 0.1\text{nH}$ | 4 | 100 | 10,000 | >13000 | 0.08 | 0.05 | 250 | |
| 0N6 | 0.6 | $\pm 0.3\text{nH}, \pm 0.2\text{nH}, \pm 0.1\text{nH}$ | 4 | 100 | 10,000 | >13000 | 0.08 | 0.05 | 250 | |
| 0N7 | 0.7 | $\pm 0.3\text{nH}, \pm 0.2\text{nH}, \pm 0.1\text{nH}$ | 4 | 100 | 10,000 | >13000 | 0.09 | 0.06 | 250 | |
| 0N8 | 0.8 | $\pm 0.3\text{nH}, \pm 0.2\text{nH}, \pm 0.1\text{nH}$ | 4 | 100 | 10,000 | >13000 | 0.10 | 0.07 | 250 | |
| 0N9 | 0.9 | $\pm 0.3\text{nH}, \pm 0.2\text{nH}, \pm 0.1\text{nH}$ | 4 | 100 | 10,000 | >13000 | 0.10 | 0.07 | 250 | |
| 1N0 | 1.0 | $\pm 0.3\text{nH}, \pm 0.2\text{nH}, \pm 0.1\text{nH}$ | 4 | 100 | 10,000 | >13000 | 0.14 | 0.09 | 250 | |
| 1N1 | 1.1 | $\pm 0.3\text{nH}, \pm 0.2\text{nH}, \pm 0.1\text{nH}$ | 4 | 100 | 10,000 | >13000 | 0.14 | 0.09 | 250 | |
| 1N2 | 1.2 | $\pm 0.3\text{nH}, \pm 0.2\text{nH}, \pm 0.1\text{nH}$ | 4 | 100 | 10,000 | >13000 | 0.14 | 0.09 | 250 | |
| 1N3 | 1.3 | $\pm 0.3\text{nH}, \pm 0.2\text{nH}, \pm 0.1\text{nH}$ | 4 | 100 | 10,000 | >13000 | 0.14 | 0.10 | 250 | |
| 1N5 | 1.5 | $\pm 0.3\text{nH}, \pm 0.2\text{nH}, \pm 0.1\text{nH}$ | 4 | 100 | 10,000 | >13000 | 0.18 | 0.10 | 230 | |
| 1N6 | 1.6 | $\pm 0.3\text{nH}, \pm 0.2\text{nH}, \pm 0.1\text{nH}$ | 4 | 100 | 10,000 | >13000 | 0.18 | 0.12 | 230 | |
| 1N8 | 1.8 | $\pm 0.3\text{nH}, \pm 0.2\text{nH}, \pm 0.1\text{nH}$ | 4 | 100 | 10,000 | >13000 | 0.19 | 0.13 | 200 | |
| 2N0 | 2.0 | $\pm 0.3\text{nH}, \pm 0.2\text{nH}, \pm 0.1\text{nH}$ | 4 | 100 | 8,800 | >13000 | 0.20 | 0.14 | 200 | |
| 2N1 | 2.1 | $\pm 0.3\text{nH}, \pm 0.2\text{nH}, \pm 0.1\text{nH}$ | 4 | 100 | 8,800 | >13000 | 0.20 | 0.15 | 200 | |
| 2N2 | 2.2 | $\pm 0.3\text{nH}, \pm 0.2\text{nH}, \pm 0.1\text{nH}$ | 4 | 100 | 8,800 | >13000 | 0.22 | 0.15 | 200 | |
| 2N4 | 2.4 | $\pm 0.3\text{nH}, \pm 0.2\text{nH}, \pm 0.1\text{nH}$ | 4 | 100 | 8,300 | 11,700 | 0.24 | 0.15 | 200 | |
| 2N7 | 2.7 | $\pm 0.3\text{nH}, \pm 0.2\text{nH}, \pm 0.1\text{nH}$ | 5 | 100 | 7,700 | 11,340 | 0.25 | 0.17 | 200 | |
| 3N0 | 3.0 | $\pm 0.3\text{nH}, \pm 0.2\text{nH}, \pm 0.1\text{nH}$ | 5 | 100 | 7,200 | 11,000 | 0.28 | 0.20 | 180 | |
| 3N2 | 3.2 | $\pm 0.3\text{nH}, \pm 0.2\text{nH}, \pm 0.1\text{nH}$ | 5 | 100 | 6,700 | 10,800 | 0.30 | 0.20 | 180 | |
| 3N3 | 3.3 | $\pm 0.3\text{nH}, \pm 0.2\text{nH}, \pm 0.1\text{nH}$ | 5 | 100 | 6,700 | 10,400 | 0.30 | 0.20 | 180 | |
| 3N6 | 3.6 | $\pm 0.3\text{nH}, \pm 0.2\text{nH}, \pm 0.1\text{nH}$ | 5 | 100 | 6,400 | 9,000 | 0.30 | 0.23 | 170 | |
| 3N9 | 3.9 | $\pm 0.3\text{nH}, \pm 0.2\text{nH}, \pm 0.1\text{nH}$ | 5 | 100 | 6,000 | 8,790 | 0.30 | 0.23 | 170 | |
| 4N3 | 4.3 | $\pm 0.3\text{nH}, \pm 0.2\text{nH}, \pm 0.1\text{nH}$ | 5 | 100 | 5,700 | 8,000 | 0.40 | 0.24 | 150 | |
| 4N7 | 4.7 | $\pm 0.3\text{nH}, \pm 0.2\text{nH}, \pm 0.1\text{nH}$ | 5 | 100 | 5,300 | 7,750 | 0.40 | 0.26 | 150 | |
| 5N1 | 5.1 | $\pm 0.3\text{nH}, \pm 0.2\text{nH}, \pm 0.1\text{nH}$ | 5 | 100 | 5,000 | 7,210 | 0.40 | 0.26 | 150 | |
| 5N6 | 5.6 | $\pm 0.3\text{nH}, \pm 0.2\text{nH}, \pm 0.1\text{nH}$ | 5 | 100 | 4,200 | 6,680 | 0.40 | 0.32 | 150 | |
| 6N2 | 6.2 | $\pm 0.3\text{nH}, \pm 0.2\text{nH}, \pm 0.1\text{nH}$ | 5 | 100 | 3,800 | 6,800 | 0.44 | 0.32 | 150 | |
| 6N8 | 6.8 | $\pm 5\%, \pm 3\%$ | 5 | 100 | 3,500 | 6,800 | 0.50 | 0.34 | 150 | |
| 7N5 | 7.5 | $\pm 5\%, \pm 3\%$ | 5 | 100 | 3,300 | 6,000 | 0.53 | 0.36 | 150 | |
| 8N2 | 8.2 | $\pm 5\%, \pm 3\%$ | 5 | 100 | 3,200 | 5,800 | 0.55 | 0.38 | 150 | |
| 9N1 | 9.1 | $\pm 5\%, \pm 3\%$ | 5 | 100 | 3,000 | 5,000 | 0.62 | 0.38 | 150 | |
| 10N | 10 | $\pm 5\%, \pm 3\%$ | 5 | 100 | 2,800 | 4,860 | 0.65 | 0.40 | 150 | |
| 12N | 12 | $\pm 5\%, \pm 3\%$ | 5 | 100 | 2,400 | 4,520 | 0.70 | 0.50 | 100 | |
| 15N | 15 | $\pm 5\%, \pm 3\%$ | 5 | 100 | 2,200 | 4,820 | 0.80 | 0.60 | 100 | |
| 18N | 18 | $\pm 5\%, \pm 3\%$ | 5 | 100 | 2,200 | 3,000 | 0.90 | 0.85 | 100 | |
| 22N | 22 | $\pm 5\%, \pm 3\%$ | 5 | 100 | 1,800 | 2,950 | 1.20 | 0.86 | 100 | |
| 27N | 27 | $\pm 5\%, \pm 3\%$ | 4 | 100 | 1,800 | 2,610 | 1.80 | 0.88 | 50 | |
| 33N | 33 | $\pm 5\%$ | 4 | 100 | 1,700 | 2,210 | 2.10 | 1.05 | 50 | |
| 39N | 39 | $\pm 5\%$ | 4 | 100 | 1,500 | 1,860 | 2.40 | 1.18 | 50 | |
| 47N | 47 | $\pm 5\%$ | 4 | 100 | 1,300 | 1,800 | 2.80 | 1.74 | 100 | |
| 56N | 56 | $\pm 5\%$ | 4 | 100 | 1,100 | 1,600 | 3.00 | 1.85 | 80 | |
| 68N | 68 | $\pm 5\%$ | 4 | 100 | 1,100 | 1,500 | 2.66 | 2.30 | 80 | |
| 82N | 82 | $\pm 5\%$ | 4 | 100 | 1,000 | 1,400 | 3.37 | 2.60 | 70 | |
| R10 | 100 | $\pm 5\%$ | 4 | 100 | 900 | 1,200 | 3.74 | 3.00 | 60 | |

Tolerance: B = $\pm 0.1\text{nH}$, C = $\pm 0.2\text{nH}$, S = $\pm 0.3\text{nH}$, G = $\pm 2\%$, H = $\pm 3\%$, J = $\pm 5\%$, K = $\pm 10\%$
 Measuring Equipment: HP4287+16196C
 Measuring Temperature: $25 \pm 3^\circ\text{C}$ Operating
 Temperature: -55°C to $+125^\circ\text{C}$



Multi-Layer High Frequency Ceramic Chip Inductors



LCMC Series

L, Q VS. FREQUENCY CHARACTERISTICS

| 0201 | | | | | | | | | | | | | | |
|---------------|-------------------------|---------|---------|---------|---------|---------|---------|-----------|---------|---------|---------|---------|---------|---------|
| Ordering Code | Typical Inductance (nH) | | | | | | | Typical Q | | | | | | |
| | 100 MHz | 500 MHz | 800 MHz | 900 MHz | 1.8 GHz | 2.0 GHz | 2.4 GHz | 100 MHz | 500 MHz | 800 MHz | 900 MHz | 1.8 GHz | 2.0 GHz | 2.4 GHz |
| 0N3 | 0.3 | 0.3 | 0.3 | 0.3 | 0.3 | 0.3 | 0.3 | 6 | 14 | 19 | 20 | 32 | 35 | 39 |
| 0N4 | 0.4 | 0.4 | 0.4 | 0.4 | 0.4 | 0.4 | 0.4 | 6 | 14 | 19 | 20 | 32 | 35 | 39 |
| 0N5 | 0.5 | 0.5 | 0.5 | 0.5 | 0.5 | 0.5 | 0.5 | 6 | 14 | 19 | 20 | 33 | 36 | 40 |
| 0N6 | 0.6 | 0.6 | 0.5 | 0.5 | 0.5 | 0.5 | 0.5 | 6 | 15 | 19 | 20 | 33 | 36 | 40 |
| 0N7 | 0.7 | 0.7 | 0.6 | 0.6 | 0.6 | 0.6 | 0.6 | 6 | 15 | 20 | 21 | 34 | 37 | 41 |
| 0N8 | 0.8 | 0.8 | 0.7 | 0.7 | 0.7 | 0.7 | 0.7 | 6 | 14 | 19 | 20 | 32 | 35 | 39 |
| 0N9 | 0.9 | 0.8 | 0.8 | 0.8 | 0.8 | 0.8 | 0.8 | 6 | 15 | 20 | 21 | 35 | 37 | 42 |
| 1N0 | 1.0 | 0.9 | 0.9 | 0.9 | 0.9 | 0.9 | 0.9 | 5 | 13 | 17 | 18 | 28 | 30 | 33 |
| 1N1 | 1.1 | 1.0 | 1.0 | 1.0 | 0.9 | 0.9 | 0.9 | 6 | 14 | 18 | 20 | 30 | 32 | 34 |
| 1N2 | 1.2 | 1.2 | 1.2 | 1.2 | 1.2 | 1.2 | 1.2 | 6 | 14 | 18 | 19 | 28 | 30 | 32 |
| 1N3 | 1.3 | 1.2 | 1.2 | 1.2 | 1.2 | 1.2 | 1.2 | 6 | 13 | 17 | 18 | 27 | 28 | 31 |
| 1N5 | 1.5 | 1.4 | 1.3 | 1.3 | 1.4 | 1.4 | 1.4 | 6 | 14 | 18 | 20 | 30 | 32 | 34 |
| 1N6 | 1.6 | 1.6 | 1.6 | 1.6 | 1.6 | 1.6 | 1.6 | 6 | 14 | 18 | 20 | 28 | 30 | 31 |
| 1N8 | 1.8 | 1.7 | 1.7 | 1.7 | 1.7 | 1.7 | 1.7 | 6 | 14 | 18 | 20 | 28 | 30 | 31 |
| 2N0 | 2.0 | 1.9 | 1.9 | 1.9 | 2.0 | 1.9 | 2.0 | 6 | 14 | 18 | 19 | 28 | 29 | 31 |
| 2N1 | 2.1 | 2.0 | 1.9 | 1.9 | 2.0 | 2.0 | 2.1 | 6 | 13 | 17 | 18 | 26 | 28 | 30 |
| 2N2 | 2.2 | 2.1 | 2.0 | 2.0 | 2.1 | 2.1 | 2.2 | 6 | 13 | 17 | 18 | 26 | 28 | 30 |
| 2N4 | 2.4 | 2.3 | 2.2 | 2.2 | 2.3 | 2.4 | 2.5 | 6 | 14 | 18 | 20 | 28 | 29 | 31 |
| 2N7 | 2.7 | 2.5 | 2.5 | 2.5 | 2.6 | 2.7 | 2.8 | 6 | 14 | 18 | 19 | 28 | 29 | 31 |
| 3N0 | 3.0 | 2.8 | 2.8 | 2.8 | 2.9 | 2.9 | 3.0 | 7 | 15 | 19 | 21 | 30 | 31 | 33 |
| 3N2 | 3.2 | 3.0 | 3.0 | 3.0 | 3.1 | 3.1 | 3.2 | 6 | 14 | 19 | 20 | 29 | 30 | 32 |
| 3N3 | 3.3 | 3.2 | 3.1 | 3.2 | 3.0 | 3.4 | 3.5 | 6 | 14 | 19 | 20 | 29 | 30 | 32 |
| 3N6 | 3.6 | 3.4 | 3.4 | 3.4 | 3.7 | 3.7 | 3.9 | 6 | 14 | 18 | 20 | 28 | 29 | 31 |
| 3N9 | 3.9 | 3.7 | 3.7 | 3.7 | 3.9 | 4.0 | 4.2 | 6 | 15 | 19 | 20 | 28 | 29 | 31 |
| 4N3 | 4.3 | 4.1 | 4.1 | 4.1 | 4.4 | 4.9 | 4.8 | 6 | 14 | 18 | 19 | 27 | 28 | 29 |
| 4N7 | 4.7 | 4.4 | 4.4 | 4.4 | 4.8 | 4.9 | 5.2 | 6 | 14 | 19 | 19 | 26 | 27 | 29 |
| 5N1 | 5.1 | 4.9 | 4.9 | 4.9 | 5.4 | 5.6 | 6.0 | 6 | 13 | 17 | 18 | 25 | 25 | 26 |
| 5N6 | 5.6 | 5.3 | 5.3 | 5.3 | 5.8 | 6.0 | 6.6 | 7 | 14 | 18 | 19 | 26 | 27 | 27 |
| 6N2 | 6.2 | 6.0 | 6.0 | 6.1 | 6.9 | 7.2 | 8.1 | 6 | 14 | 18 | 19 | 26 | 26 | 30 |
| 6N8 | 6.8 | 6.3 | 6.4 | 6.4 | 7.2 | 7.4 | 8.2 | 7 | 14 | 18 | 19 | 26 | 26 | 26 |
| 7N5 | 7.5 | 7.1 | 7.2 | 7.2 | 8.3 | 8.7 | 9.8 | 6 | 15 | 18 | 20 | 25 | 25 | 25 |
| 8N2 | 8.2 | 7.8 | 7.9 | 8.0 | 9.2 | 9.7 | 11.0 | 7 | 15 | 18 | 19 | 19 | 24 | 24 |
| 9N1 | 9.1 | 8.7 | 8.8 | 8.9 | 10.8 | 11.6 | 13.9 | 6 | 13 | 16 | 17 | 21 | 20 | 18 |
| 10N | 10.0 | 9.3 | 9.5 | 9.6 | 12.0 | 13.0 | 16.1 | 6 | 13 | 16 | 17 | 20 | 20 | 18 |
| 12N | 12.0 | 11.3 | 11.5 | 11.7 | 15.4 | 17.2 | 23.2 | 7 | 13 | 16 | 17 | 18 | 17 | 14 |
| 15N | 15.0 | 14.5 | 15.1 | 15.4 | 22.4 | 26.2 | 42.3 | 7 | 15 | 18 | 19 | 19 | 17 | 11 |
| 18N | 18.0 | 17.2 | 18.1 | 18.6 | 31.1 | 39.5 | 99.3 | 7 | 13 | 16 | 16 | 14 | 11 | 5 |
| 22N | 22.0 | 21.4 | 22.8 | 23.5 | 45.5 | 64.1 | - | 7 | 13 | 16 | 16 | 12 | 8 | - |
| 27N | 27.0 | 26.6 | 29.2 | 30.6 | 108.5 | - | - | 6 | 13 | 15 | 15 | 6 | - | - |
| 33N | 33.0 | 31.9 | 34.8 | 36.0 | 119.0 | - | - | 7 | 14 | 16 | 17 | 6 | - | - |
| 39N | 39.0 | 38.2 | 42.3 | 45.6 | - | - | - | 6 | 12 | 13 | 13 | - | - | - |
| 47N | 47.0 | 44.0 | 47.0 | 49.0 | - | - | - | 6 | 11 | 12 | 11 | - | - | - |
| 56N | 56.0 | 54.0 | 61.0 | 66.0 | - | - | - | 6 | 11 | 11 | 10 | - | - | - |
| 68N | 68.0 | 66.0 | 76.0 | 82.0 | - | - | - | 6 | 11 | 11 | 10 | - | - | - |
| 82N | 82.0 | 80.0 | 97.0 | 108.0 | - | - | - | 6 | 11 | 10 | 8 | - | - | - |
| R10 | 100.0 | 103.0 | 138.0 | 164.0 | - | - | - | 6 | 10 | 9 | 6 | - | - | - |

Tolerance: B = ±0.1nH, C = ±0.2nH, S = ±0.3nH, G = ±2%, H = ±3%, J = ±5%, K = ±10%
 Measuring Equipment: HP4287+16196C
 Measuring Temperature: 25 ± 3°C
 Operating Temperature: -55°C to +125°C



Multi-Layer High Frequency Ceramic Chip Inductors



LCMC Series

0201 L VS FREQUENCY

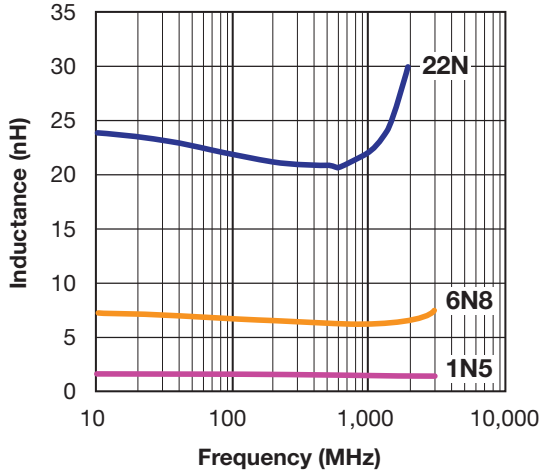

0201 Q VS FREQUENCY

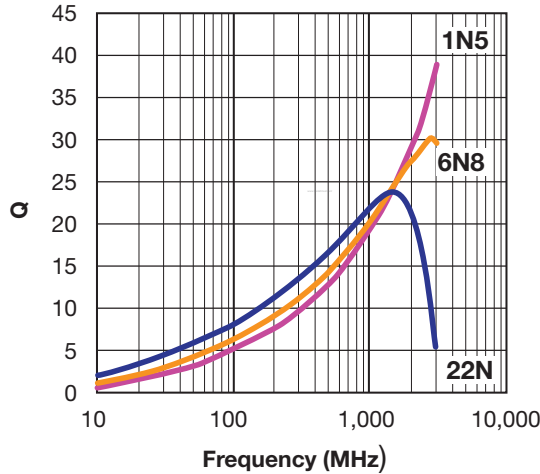

0201 Z VS FREQUENCY

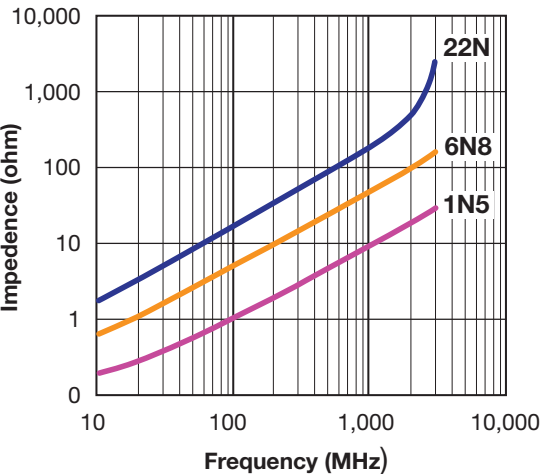

Multi-Layer High Frequency Ceramic Chip Inductors



LCMC Series

ELECTRICAL CHARACTERISTICS

| 0402 | | | | | | | | | | |
|---------------|-----------------|--|--------|--------------------------------|--------------------------------|--------|----------------------------|------|-------------------------|-------------------------------|
| Ordering Code | Inductance (nH) | Available Tolerance | Q Min. | L, Q Measuring Frequency (MHz) | Self-Resonance Frequency (MHz) | | DC Resistance (Ω) | | Rated Current (mA) Max. | Packing Amount of 7" Reel Pcs |
| | | | | | Min. | Typ. | Max. | Typ. | | |
| 0N6 | 0.6 | $\pm 0.3\text{nH}, \pm 0.2\text{nH}, \pm 0.1\text{nH}$ | 8 | 100 | 10000 | >13000 | 0.08 | 0.02 | 300 | 10,000 |
| 1N0 | 1.0 | $\pm 0.3\text{nH}, \pm 0.2\text{nH}, \pm 0.1\text{nH}$ | 8 | 100 | 10000 | >13000 | 0.08 | 0.02 | 300 | |
| 1N1 | 1.1 | $\pm 0.3\text{nH}, \pm 0.2\text{nH}, \pm 0.1\text{nH}$ | 8 | 100 | 10000 | >13000 | 0.08 | 0.03 | 300 | |
| 1N2 | 1.2 | $\pm 0.3\text{nH}, \pm 0.2\text{nH}, \pm 0.1\text{nH}$ | 8 | 100 | 10000 | >13000 | 0.09 | 0.03 | 300 | |
| 1N3 | 1.3 | $\pm 0.3\text{nH}, \pm 0.2\text{nH}, \pm 0.1\text{nH}$ | 8 | 100 | 10000 | >13000 | 0.09 | 0.04 | 300 | |
| 1N5 | 1.5 | $\pm 0.3\text{nH}, \pm 0.2\text{nH}, \pm 0.1\text{nH}$ | 8 | 100 | 10000 | >13000 | 0.10 | 0.05 | 300 | |
| 1N6 | 1.6 | $\pm 0.3\text{nH}, \pm 0.2\text{nH}, \pm 0.1\text{nH}$ | 8 | 100 | 10000 | >13000 | 0.10 | 0.05 | 300 | |
| 1N8 | 1.8 | $\pm 0.3\text{nH}, \pm 0.2\text{nH}, \pm 0.1\text{nH}$ | 8 | 100 | 6000 | 12220 | 0.12 | 0.05 | 300 | |
| 2N0 | 2.0 | $\pm 0.3\text{nH}, \pm 0.2\text{nH}, \pm 0.1\text{nH}$ | 8 | 100 | 6000 | 12890 | 0.12 | 0.06 | 300 | |
| 2N2 | 2.2 | $\pm 0.3\text{nH}, \pm 0.2\text{nH}, \pm 0.1\text{nH}$ | 8 | 100 | 6000 | 12430 | 0.13 | 0.06 | 300 | |
| 2N4 | 2.4 | $\pm 0.3\text{nH}, \pm 0.2\text{nH}, \pm 0.1\text{nH}$ | 8 | 100 | 6000 | 12320 | 0.13 | 0.07 | 300 | |
| 2N7 | 2.7 | $\pm 0.3\text{nH}, \pm 0.2\text{nH}, \pm 0.1\text{nH}$ | 8 | 100 | 6000 | 10070 | 0.16 | 0.09 | 300 | |
| 3N0 | 3.0 | $\pm 0.3\text{nH}, \pm 0.2\text{nH}, \pm 0.1\text{nH}$ | 8 | 100 | 6000 | 8760 | 0.16 | 0.09 | 300 | |
| 3N3 | 3.3 | $\pm 0.3\text{nH}, \pm 0.2\text{nH}, \pm 0.1\text{nH}$ | 8 | 100 | 6000 | 8120 | 0.16 | 0.09 | 300 | |
| 3N6 | 3.6 | $\pm 0.3\text{nH}, \pm 0.2\text{nH}, \pm 0.1\text{nH}$ | 8 | 100 | 5000 | 8200 | 0.20 | 0.10 | 300 | |
| 3N9 | 3.9 | $\pm 0.3\text{nH}, \pm 0.2\text{nH}, \pm 0.1\text{nH}$ | 8 | 100 | 4000 | 8390 | 0.20 | 0.10 | 300 | |
| 4N3 | 4.3 | $\pm 0.3\text{nH}, \pm 0.2\text{nH}, \pm 0.1\text{nH}$ | 8 | 100 | 4000 | 7500 | 0.20 | 0.11 | 300 | |
| 4N7 | 4.7 | $\pm 0.3\text{nH}, \pm 0.2\text{nH}, \pm 0.1\text{nH}$ | 8 | 100 | 4000 | 7010 | 0.20 | 0.11 | 300 | |
| 5N1 | 5.1 | $\pm 0.3\text{nH}, \pm 0.2\text{nH}, \pm 0.1\text{nH}$ | 8 | 100 | 4000 | 6340 | 0.23 | 0.13 | 300 | |
| 5N6 | 5.6 | $\pm 0.3\text{nH}, \pm 0.2\text{nH}, \pm 0.1\text{nH}$ | 8 | 100 | 4000 | 5760 | 0.23 | 0.13 | 300 | |
| 6N2 | 6.2 | $\pm 0.3\text{nH}, \pm 0.2\text{nH}, \pm 0.1\text{nH}$ | 8 | 100 | 3900 | 5490 | 0.25 | 0.15 | 300 | |
| 6N8 | 6.8 | $\pm 5\%, \pm 2\%$ | 8 | 100 | 3900 | 5430 | 0.25 | 0.14 | 300 | |
| 7N5 | 7.5 | $\pm 5\%, \pm 2\%$ | 8 | 100 | 3700 | 5000 | 0.28 | 0.16 | 300 | |
| 8N2 | 8.2 | $\pm 5\%, \pm 2\%$ | 8 | 100 | 3500 | 4660 | 0.28 | 0.17 | 300 | |
| 9N1 | 9.1 | $\pm 5\%, \pm 2\%$ | 8 | 100 | 3400 | 4400 | 0.30 | 0.22 | 300 | |
| 10N | 10 | $\pm 5\%, \pm 2\%$ | 8 | 100 | 3200 | 4120 | 0.31 | 0.24 | 300 | |
| 12N | 12 | $\pm 5\%, \pm 2\%$ | 8 | 100 | 2600 | 3820 | 0.45 | 0.30 | 300 | |
| 15N | 15 | $\pm 5\%, \pm 2\%$ | 8 | 100 | 2300 | 3350 | 0.55 | 0.38 | 300 | |
| 18N | 18 | $\pm 5\%, \pm 2\%$ | 8 | 100 | 2000 | 2970 | 0.65 | 0.37 | 300 | |
| 22N | 22 | $\pm 5\%, \pm 2\%$ | 8 | 100 | 1600 | 2640 | 0.70 | 0.45 | 300 | |
| 27N | 27 | $\pm 5\%, \pm 2\%$ | 8 | 100 | 1400 | 2370 | 0.80 | 0.49 | 300 | |
| 33N | 33 | $\pm 5\%, \pm 2\%$ | 8 | 100 | 1200 | 2040 | 0.90 | 0.63 | 200 | |
| 39N | 39 | $\pm 5\%, \pm 2\%$ | 8 | 100 | 1100 | 1800 | 1.00 | 0.70 | 200 | |
| 47N | 47 | $\pm 5\%, \pm 2\%$ | 8 | 100 | 900 | 1660 | 1.10 | 0.82 | 200 | |
| 56N | 56 | $\pm 5\%, \pm 2\%$ | 8 | 100 | 750 | 1560 | 1.10 | 0.84 | 200 | |
| 68N | 68 | $\pm 5\%, \pm 2\%$ | 8 | 100 | 750 | 1330 | 1.20 | 0.99 | 180 | |
| 82N | 82 | $\pm 5\%, \pm 2\%$ | 8 | 100 | 600 | 1160 | 1.30 | 1.09 | 150 | |
| R10 | 100 | $\pm 5\%, \pm 2\%$ | 8 | 100 | 600 | 1020 | 1.60 | 1.19 | 150 | |
| R12 | 120 | $\pm 5\%, \pm 2\%$ | 8 | 100 | 600 | 860 | 1.60 | 1.31 | 150 | |
| R15 | 150 | $\pm 5\%, \pm 2\%$ | 8 | 100 | 550 | 800 | 2.40 | 1.58 | 140 | |
| R18 | 180 | $\pm 5\%, \pm 2\%$ | 8 | 100 | 500 | 810 | 3.70 | 2.97 | 130 | |
| R22 | 220 | $\pm 5\%, \pm 2\%$ | 8 | 100 | 450 | 700 | 4.20 | 3.29 | 120 | |
| R27 | 270 | $\pm 5\%, \pm 2\%$ | 8 | 100 | 400 | 600 | 4.80 | 3.92 | 110 | |

Tolerance: B = $\pm 0.1\text{nH}$, C = $\pm 0.2\text{nH}$, S = $\pm 0.3\text{nH}$, G = $\pm 2\%$, H = $\pm 3\%$, J = $\pm 5\%$, K = $\pm 10\%$
 Measuring Equipment: HP4287+16196C
 Measuring Temperature: $25 \pm 3^\circ\text{C}$
 Operating Temperature: -55°C to $+125^\circ\text{C}$



Multi-Layer High Frequency Ceramic Chip Inductors



LCMC Series

L, Q VS. FREQUENCY CHARACTERISTICS

| 0402 | | | | | | | | | | | | | | |
|---------------|-------------------------|---------|---------|---------|---------|---------|---------|-----------|---------|---------|---------|---------|---------|---------|
| Ordering Code | Typical Inductance (nH) | | | | | | | Typical Q | | | | | | |
| | 100 MHz | 500 MHz | 800 MHz | 900 MHz | 1.8 GHz | 2.0 GHz | 2.4 GHz | 100 MHz | 500 MHz | 800 MHz | 900 MHz | 1.8 GHz | 2.0 GHz | 2.4 GHz |
| 0N6 | 0.6 | 0.6 | 0.6 | 0.6 | 0.6 | 0.6 | 0.6 | 12 | 40 | 60 | 65 | 100 | 120 | 140 |
| 1N0 | 1.0 | 1.0 | 1.0 | 1.0 | 1.0 | 1.0 | 1.0 | 12 | 29 | 38 | 41 | 63 | 71 | 75 |
| 1N1 | 1.1 | 1.1 | 1.1 | 1.1 | 1.1 | 1.1 | 1.1 | 11 | 29 | 37 | 40 | 60 | 67 | 72 |
| 1N2 | 1.2 | 1.2 | 1.2 | 1.2 | 1.2 | 1.2 | 1.2 | 11 | 29 | 38 | 41 | 61 | 68 | 73 |
| 1N3 | 1.3 | 1.3 | 1.3 | 1.3 | 1.3 | 1.3 | 1.3 | 11 | 30 | 38 | 41 | 61 | 67 | 72 |
| 1N5 | 1.5 | 1.5 | 1.5 | 1.5 | 1.5 | 1.5 | 1.5 | 11 | 27 | 35 | 38 | 57 | 63 | 68 |
| 1N6 | 1.6 | 1.5 | 1.5 | 1.5 | 1.5 | 1.5 | 1.5 | 11 | 28 | 35 | 38 | 57 | 64 | 68 |
| 1N8 | 1.8 | 1.7 | 1.7 | 1.7 | 1.7 | 1.7 | 1.8 | 11 | 26 | 33 | 36 | 53 | 58 | 61 |
| 2N0 | 2.0 | 2.0 | 2.0 | 2.0 | 2.0 | 2.1 | 2.1 | 10 | 23 | 29 | 31 | 45 | 49 | 52 |
| 2N2 | 2.2 | 2.1 | 2.1 | 2.1 | 2.2 | 2.2 | 2.2 | 10 | 24 | 31 | 33 | 48 | 52 | 55 |
| 2N4 | 2.4 | 2.3 | 2.3 | 2.3 | 2.4 | 2.4 | 2.4 | 10 | 25 | 31 | 34 | 49 | 53 | 57 |
| 2N7 | 2.7 | 2.7 | 2.7 | 2.7 | 2.8 | 2.8 | 2.9 | 11 | 27 | 35 | 37 | 54 | 58 | 60 |
| 3N0 | 3.0 | 2.9 | 2.9 | 3.0 | 3.1 | 3.1 | 3.2 | 10 | 25 | 32 | 34 | 49 | 53 | 55 |
| 3N3 | 3.3 | 3.2 | 3.2 | 3.2 | 3.4 | 3.4 | 3.5 | 11 | 25 | 32 | 35 | 50 | 54 | 56 |
| 3N6 | 3.6 | 3.5 | 3.5 | 3.5 | 3.7 | 3.8 | 3.9 | 10 | 24 | 31 | 33 | 46 | 49 | 49 |
| 3N9 | 3.9 | 3.7 | 3.7 | 3.8 | 3.9 | 4.0 | 4.1 | 11 | 24 | 30 | 33 | 46 | 49 | 51 |
| 4N3 | 4.3 | 4.1 | 4.2 | 4.2 | 4.4 | 4.4 | 4.6 | 11 | 26 | 33 | 35 | 50 | 53 | 54 |
| 4N7 | 4.7 | 4.5 | 4.5 | 4.5 | 4.8 | 4.9 | 5.1 | 11 | 25 | 32 | 35 | 49 | 51 | 53 |
| 5N1 | 5.1 | 4.9 | 4.9 | 4.9 | 5.2 | 5.3 | 5.6 | 11 | 25 | 32 | 35 | 46 | 48 | 49 |
| 5N6 | 5.6 | 5.5 | 5.5 | 5.5 | 6.0 | 6.2 | 6.7 | 11 | 25 | 32 | 35 | 46 | 48 | 49 |
| 6N2 | 6.2 | 6.1 | 6.1 | 6.1 | 6.7 | 6.8 | 7.3 | 11 | 26 | 32 | 34 | 46 | 48 | 49 |
| 6N8 | 6.8 | 6.6 | 6.7 | 6.7 | 7.4 | 7.6 | 8.2 | 11 | 26 | 32 | 35 | 46 | 48 | 48 |
| 7N5 | 7.5 | 7.1 | 7.2 | 7.3 | 7.8 | 8.1 | 8.8 | 11 | 26 | 32 | 35 | 46 | 48 | 48 |
| 8N2 | 8.2 | 8.0 | 8.1 | 8.2 | 9.4 | 9.9 | 11.1 | 11 | 26 | 32 | 34 | 42 | 42 | 40 |
| 9N1 | 9.1 | 8.7 | 8.8 | 8.8 | 9.9 | 10.2 | 11.1 | 11 | 25 | 31 | 34 | 42 | 42 | 40 |
| 10N | 10.0 | 10.0 | 9.8 | 9.9 | 11.7 | 12.4 | 14.4 | 11 | 23 | 29 | 31 | 37 | 37 | 34 |
| 12N | 12.0 | 11.7 | 12.0 | 12.2 | 15.1 | 16.3 | 20.1 | 11 | 24 | 31 | 33 | 37 | 36 | 30 |
| 15N | 15.0 | 14.9 | 15.5 | 15.8 | 22.8 | 26.4 | 41.8 | 11 | 23 | 30 | 32 | 35 | 33 | 28 |
| 18N | 18.0 | 17.8 | 18.4 | 18.7 | 24.9 | 27.7 | 37.7 | 11 | 23 | 28 | 29 | 30 | 28 | 22 |
| 22N | 22.0 | 21.8 | 23.1 | 23.8 | 40.9 | 52.7 | 156.0 | 11 | 22 | 27 | 28 | 22 | 18 | 6 |
| 27N | 27.0 | 27.1 | 29.2 | 30.3 | 66.8 | 106.9 | - | 11 | 22 | 26 | 27 | 16 | 11 | 4 |
| 33N | 33.0 | 33.2 | 36.3 | 37.9 | 109.0 | 259.0 | - | 11 | 22 | 25 | 26 | 12 | 5 | - |
| 39N | 39.0 | 40.2 | 45.9 | 49.1 | - | - | - | 11 | 20 | 22 | 22 | - | - | - |
| 47N | 47.0 | 49.1 | 57.2 | 61.7 | - | - | - | 11 | 20 | 21 | 21 | - | - | - |
| 56N | 56.0 | 59.2 | 71.8 | 79.3 | - | - | - | 11 | 19 | 19 | 18 | - | - | - |
| 68N | 68.0 | 74.7 | 99.4 | 116.3 | - | - | - | 11 | 18 | 17 | 15 | - | - | - |
| 82N | 82.0 | 94.7 | 140.8 | 179.5 | - | - | - | 11 | 18 | 15 | 12 | - | - | - |
| R10 | 100.0 | 117.6 | 193.7 | 269.9 | - | - | - | 11 | 17 | 12 | 9 | - | - | - |
| R12 | 120.0 | 159.8 | 450.4 | - | - | - | - | 11 | 16 | 7 | - | - | - | - |
| R15 | 150.0 | 207.2 | - | - | - | - | - | 11 | 14 | - | - | - | - | - |
| R18 | 180.0 | - | - | - | - | - | - | 12 | - | - | - | - | - | - |
| R22 | 220.0 | - | - | - | - | - | - | 12 | - | - | - | - | - | - |
| R27 | 270.0 | - | - | - | - | - | - | 12 | - | - | - | - | - | - |

Multi-Layer High Frequency Ceramic Chip Inductors



LCMC Series

0402 L VS FREQUENCY

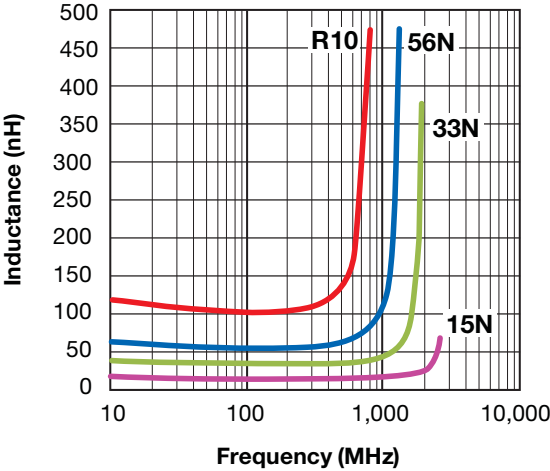

0402 Q VS FREQUENCY

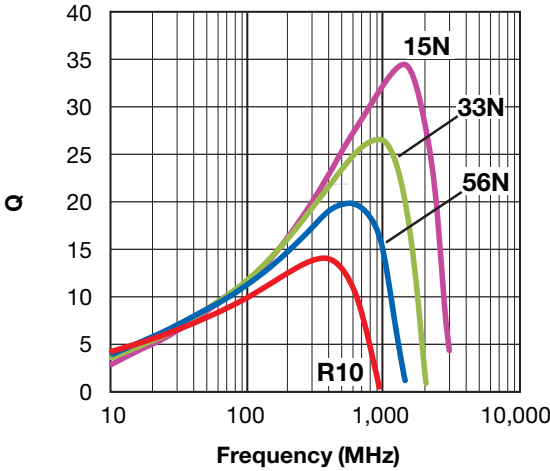

0402 Z VS FREQUENCY

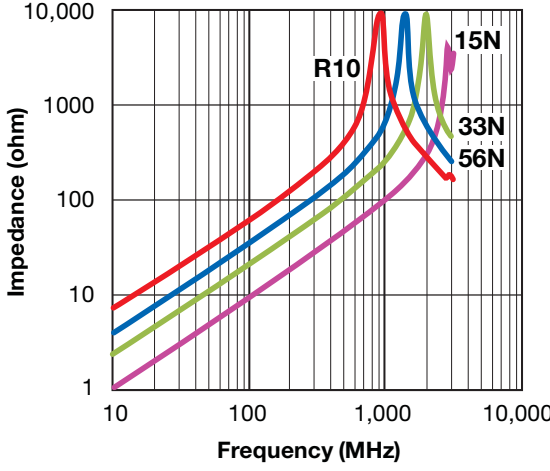

Multi-Layer High Frequency Ceramic Chip Inductors



LCMC Series

ELECTRICAL CHARACTERISTICS

0603

| Ordering Code | Inductance (nH) | Available Tolerance | Q Min. | L, Q Measuring Frequency (MHz) | Self-Resonance Frequency (MHz) | | DC Resistance (Ω) | | Rated Current (mA) Max. | Packing Amount of 7" Reel Pcs |
|---------------|-----------------|--|--------|--------------------------------|--------------------------------|--------|----------------------------|------|-------------------------|-------------------------------|
| | | | | | Min. | Typ. | Max. | Typ. | | |
| 1N0 | 1.0 | $\pm 0.3\text{nH}, \pm 0.2\text{nH}, \pm 0.1\text{nH}$ | 8 | 100 | 10000 | >13000 | 0.05 | 0.01 | 1000 | 4,000 |
| 1N2 | 1.2 | $\pm 0.3\text{nH}, \pm 0.2\text{nH}, \pm 0.1\text{nH}$ | 8 | 100 | 10000 | >13000 | 0.05 | 0.02 | 1000 | |
| 1N5 | 1.5 | $\pm 0.3\text{nH}, \pm 0.2\text{nH}, \pm 0.1\text{nH}$ | 8 | 100 | 10000 | >13000 | 0.10 | 0.03 | 1000 | |
| 1N8 | 1.8 | $\pm 0.3\text{nH}, \pm 0.2\text{nH}, \pm 0.1\text{nH}$ | 8 | 100 | 10000 | >13000 | 0.10 | 0.04 | 1000 | |
| 2N2 | 2.2 | $\pm 0.3\text{nH}, \pm 0.2\text{nH}, \pm 0.1\text{nH}$ | 8 | 100 | 6000 | 11690 | 0.10 | 0.05 | 1000 | |
| 2N7 | 2.7 | $\pm 0.3\text{nH}, \pm 0.2\text{nH}, \pm 0.1\text{nH}$ | 10 | 100 | 6000 | 8930 | 0.13 | 0.06 | 1000 | |
| 3N3 | 3.3 | $\pm 0.3\text{nH}, \pm 0.2\text{nH}, \pm 0.1\text{nH}$ | 10 | 100 | 6000 | 6440 | 0.13 | 0.07 | 1000 | |
| 3N9 | 3.9 | $\pm 0.3\text{nH}, \pm 0.2\text{nH}, \pm 0.1\text{nH}$ | 10 | 100 | 6000 | 7280 | 0.15 | 0.08 | 1000 | |
| 4N7 | 4.7 | $\pm 0.3\text{nH}, \pm 0.2\text{nH}, \pm 0.1\text{nH}$ | 10 | 100 | 4000 | 6470 | 0.20 | 0.09 | 1000 | |
| 5N6 | 5.6 | $\pm 0.3\text{nH}, \pm 0.2\text{nH}, \pm 0.1\text{nH}$ | 10 | 100 | 4000 | 5230 | 0.23 | 0.10 | 600 | |
| 6N8 | 6.8 | $\pm 5\%, \pm 2\%$ | 10 | 100 | 4000 | 5470 | 0.25 | 0.11 | 600 | |
| 8N2 | 8.2 | $\pm 5\%, \pm 2\%$ | 10 | 100 | 3500 | 4460 | 0.28 | 0.14 | 600 | |
| 10N | 10 | $\pm 5\%, \pm 2\%$ | 12 | 100 | 3200 | 4360 | 0.30 | 0.15 | 600 | |
| 12N | 12 | $\pm 5\%, \pm 2\%$ | 12 | 100 | 2600 | 3480 | 0.35 | 0.17 | 600 | |
| 15N | 15 | $\pm 5\%, \pm 2\%$ | 12 | 100 | 2300 | 3310 | 0.40 | 0.19 | 600 | |
| 18N | 18 | $\pm 5\%, \pm 2\%$ | 12 | 100 | 2000 | 3080 | 0.45 | 0.21 | 600 | |
| 22N | 22 | $\pm 5\%, \pm 2\%$ | 12 | 100 | 1600 | 2670 | 0.50 | 0.29 | 600 | |
| 27N | 27 | $\pm 5\%, \pm 2\%$ | 12 | 100 | 1400 | 2270 | 0.55 | 0.27 | 600 | |
| 33N | 33 | $\pm 5\%, \pm 2\%$ | 12 | 100 | 1200 | 1970 | 0.60 | 0.36 | 600 | |
| 39N | 39 | $\pm 5\%, \pm 2\%$ | 12 | 100 | 1100 | 1830 | 0.65 | 0.37 | 500 | |
| 47N | 47 | $\pm 5\%, \pm 2\%$ | 12 | 100 | 900 | 1670 | 0.70 | 0.47 | 500 | |
| 56N | 56 | $\pm 5\%, \pm 2\%$ | 12 | 100 | 900 | 1530 | 0.75 | 0.46 | 500 | |
| 68N | 68 | $\pm 5\%, \pm 2\%$ | 12 | 100 | 700 | 1360 | 0.85 | 0.51 | 400 | |
| 82N | 82 | $\pm 5\%, \pm 2\%$ | 12 | 100 | 600 | 1290 | 0.95 | 0.57 | 300 | |
| R10 | 100 | $\pm 5\%, \pm 2\%$ | 12 | 100 | 600 | 1090 | 1.00 | 0.69 | 300 | |
| R12 | 120 | $\pm 5\%, \pm 2\%$ | 8 | 50 | 500 | 1030 | 1.20 | 0.74 | 300 | |
| R15 | 150 | $\pm 5\%, \pm 2\%$ | 8 | 50 | 500 | 820 | 1.20 | 0.78 | 300 | |
| R18 | 180 | $\pm 5\%, \pm 2\%$ | 8 | 50 | 400 | 690 | 1.30 | 0.92 | 300 | |
| R22 | 220 | $\pm 5\%, \pm 2\%$ | 8 | 50 | 400 | 630 | 1.50 | 1.19 | 300 | |
| R24 | 240 | $\pm 5\%, \pm 2\%$ | 8 | 50 | 400 | 600 | 1.70 | 1.20 | 200 | |
| R27 | 270 | $\pm 5\%, \pm 2\%$ | 8 | 50 | 400 | 520 | 1.90 | 1.30 | 150 | |
| R33R | 330 | $\pm 5\%, \pm 2\%$ | 8 | 50 | 350 | 450 | 2.10 | 1.50 | 150 | |
| R39 | 390 | $\pm 5\%, \pm 2\%$ | 8 | 50 | 350 | 400 | 2.30 | 1.80 | 150 | |
| R47 | 470 | $\pm 5\%, \pm 2\%$ | 8 | 50 | 300 | 360 | 2.60 | 2.04 | 150 | |

Tolerance: B = $\pm 0.1\text{nH}$, C = $\pm 0.2\text{nH}$, S = $\pm 0.3\text{nH}$, G = $\pm 2\%$, H = $\pm 3\%$, J = $\pm 5\%$, K = $\pm 10\%$

Measuring Equipment: HP4291B+16192A

Measuring Temperature: $25 \pm 3^\circ\text{C}$

Operating Temperature: -40°C to $+125^\circ\text{C}$

Multi-Layer High Frequency Ceramic Chip Inductors



LCMC Series

L, Q VS. FREQUENCY CHARACTERISTICS

| 0603 | | | | | | | | | | | | | | |
|---------------|-------------------------|---------|---------|---------|---------|---------|---------|-----------|---------|---------|---------|---------|---------|---------|
| Ordering Code | Typical Inductance (nH) | | | | | | | Typical Q | | | | | | |
| | 100 MHz | 500 MHz | 800 MHz | 900 MHz | 1.8 GHz | 2.0 GHz | 2.4 GHz | 100 MHz | 500 MHz | 800 MHz | 900 MHz | 1.8 GHz | 2.0 GHz | 2.4 GHz |
| 1N0 | 1.0 | 1.1 | 1.1 | 1.1 | 1.1 | 1.1 | 1.0 | 14 | 40 | 53 | 60 | 93 | 32 | 174 |
| 1N2 | 1.2 | 1.2 | 1.2 | 1.2 | 1.2 | 1.2 | 1.1 | 14 | 38 | 49 | 54 | 84 | 32 | 143 |
| 1N5 | 1.5 | 1.6 | 1.6 | 1.6 | 1.6 | 1.5 | 1.5 | 12 | 31 | 39 | 43 | 62 | 33 | 88 |
| 1N8 | 1.8 | 1.8 | 1.8 | 1.8 | 1.8 | 1.8 | 1.7 | 13 | 34 | 42 | 46 | 68 | 37 | 97 |
| 2N2 | 2.2 | 2.2 | 2.2 | 2.2 | 2.2 | 2.2 | 2.2 | 14 | 36 | 46 | 50 | 73 | 42 | 101 |
| 2N7 | 2.7 | 2.7 | 2.7 | 2.7 | 2.7 | 2.7 | 2.7 | 14 | 36 | 47 | 45 | 72 | 45 | 94 |
| 3N3 | 3.3 | 3.3 | 3.3 | 3.3 | 3.5 | 3.5 | 3.6 | 14 | 37 | 47 | 50 | 67 | 47 | 77 |
| 3N9 | 3.9 | 3.9 | 3.9 | 3.9 | 4.0 | 4.0 | 4.1 | 15 | 36 | 46 | 49 | 66 | 48 | 81 |
| 4N7 | 4.7 | 4.6 | 4.6 | 4.7 | 4.9 | 4.9 | 5.1 | 15 | 39 | 50 | 53 | 70 | 53 | 80 |
| 5N6 | 5.6 | 5.5 | 5.6 | 5.6 | 6.1 | 6.3 | 6.7 | 15 | 39 | 50 | 54 | 67 | 52 | 69 |
| 6N8 | 6.8 | 6.7 | 6.7 | 6.8 | 7.3 | 7.5 | 7.9 | 15 | 38 | 49 | 52 | 66 | 53 | 66 |
| 8N2 | 8.2 | 8.1 | 8.2 | 8.3 | 9.5 | 9.9 | 11.0 | 16 | 37 | 48 | 50 | 59 | 49 | 54 |
| 10N | 10.0 | 9.9 | 10.1 | 10.2 | 11.7 | 12.3 | 13.9 | 16 | 39 | 49 | 52 | 60 | 50 | 52 |
| 12N | 12.0 | 12.2 | 12.6 | 12.8 | 16.6 | 18.4 | 24.4 | 16 | 36 | 46 | 48 | 47 | 39 | 31 |
| 15N | 15.0 | 15.1 | 15.6 | 15.9 | 21.0 | 23.4 | 31.9 | 17 | 40 | 50 | 52 | 49 | 41 | 31 |
| 18N | 18.0 | 18.1 | 18.9 | 19.3 | 27.7 | 32.2 | 52.2 | 17 | 39 | 48 | 50 | 43 | 35 | 21 |
| 22N | 22.0 | 22.3 | 23.8 | 24.6 | 45.7 | 63.5 | 521.1 | 17 | 39 | 46 | 47 | 29 | 19 | 1 |
| 27N | 27.0 | 27.8 | 30.3 | 31.6 | 85.8 | 191.2 | - | 18 | 39 | 45 | 46 | 19 | 8 | - |
| 33N | 33.0 | 34.9 | 38.8 | 40.9 | - | - | - | 18 | 39 | 43 | 43 | - | - | - |
| 39N | 39.0 | 41.3 | 47.7 | 51.2 | - | - | - | 19 | 36 | 39 | 37 | - | - | - |
| 47N | 47.0 | 50.0 | 58.9 | 64.0 | - | - | - | 17 | 34 | 36 | 34 | - | - | - |
| 56N | 56.0 | 62.0 | 77.7 | 87.5 | - | - | - | 19 | 35 | 34 | 31 | - | - | - |
| 68N | 68.0 | 76.8 | 103.2 | 121.7 | - | - | - | 18 | 33 | 29 | 25 | - | - | - |
| 82N | 82.0 | 96.5 | 145.3 | 187.2 | - | - | - | 19 | 32 | 25 | 20 | - | - | - |
| R10 | 100.0 | 123.7 | 222.4 | 343.5 | - | - | - | 18 | 30 | 19 | 12 | - | - | - |
| R12 | 120.0 | 156.0 | 355.0 | - | - | - | - | 19 | 28 | 14 | - | - | - | - |
| R15 | 150.0 | 227.9 | - | - | - | - | - | 18 | 21 | - | - | - | - | - |
| R18 | 180.0 | 336.8 | - | - | - | - | - | 17 | 17 | - | - | - | - | - |
| R22 | 220.0 | 520.7 | - | - | - | - | - | 16 | 13 | - | - | - | - | - |
| R24 | 240.0 | - | - | - | - | - | - | 16 | - | - | - | - | - | - |
| R27 | 270.0 | - | - | - | - | - | - | 16 | - | - | - | - | - | - |
| R33R | 330.0 | - | - | - | - | - | - | 14 | - | - | - | - | - | - |
| R39 | 390.0 | - | - | - | - | - | - | 14 | - | - | - | - | - | - |
| R47 | 470.0 | - | - | - | - | - | - | 13 | - | - | - | - | - | - |



Multi-Layer High Frequency Ceramic Chip Inductors



LCMC Series

0603 L VS FREQUENCY

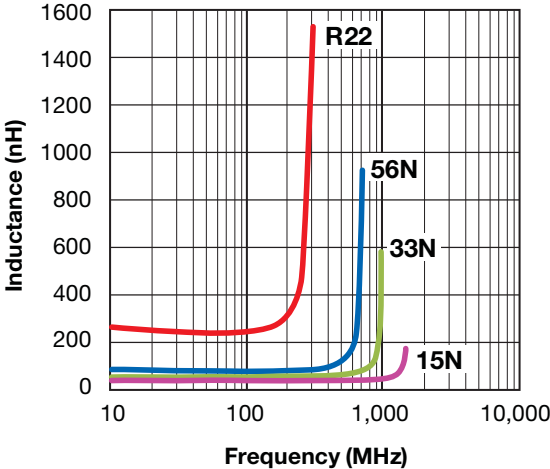

0603 Q VS FREQUENCY

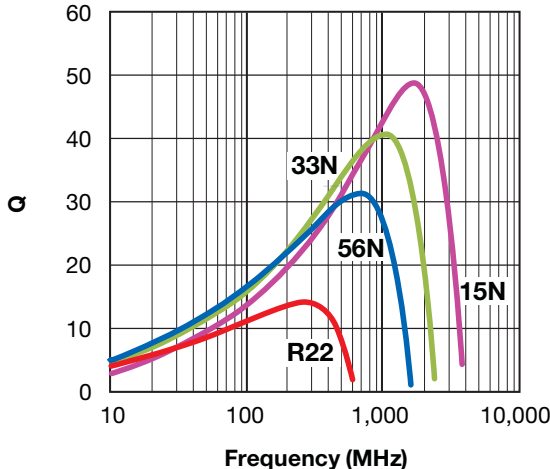

0603 Z VS FREQUENCY

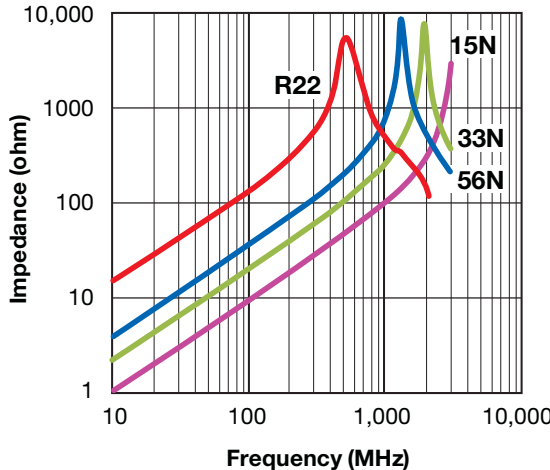

Multi-Layer High Frequency Ceramic Chip Inductors



LCMC Series

TEST CONDITION AND REQUIREMENTS

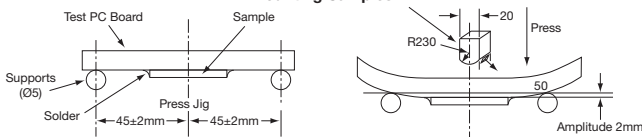
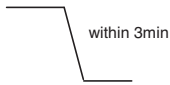
| No. | Item | Test Condition | Requirements |
|-----|----------------------------------|--|---|
| 1 | Inductance | a. Temperature: 25 ± 3°C b. Relative Humidity: 45 to 75%RH c. Measuring equipment and fixture: (0603) HP 4291+16192A (0402) HP 4287+16193A (0201) HP 4287+16196C | Within specified tolerance. |
| 2 | Q Value | a. Temperature: 25 ± 3°C b. Relative Humidity: 45 to 75%RH c. Measuring equipment and fixture: (0603) HP 4291+16192A (0402) HP 4287+16193A (0201) HP 4287+16196C | In accordance with electrical specification. |
| 3 | DC Resistance | a. Temperature: 25 ± 3°C b. Relative Humidity: 45 to 75%RH c. Measuring equipment: HP 4338. | In accordance with electrical specification. |
| 4 | Appearance | Inductors shall be visually inspected for visible evidence of defect. | In accordance with specification. |
| 5 | Dimension | Dimension shall be measured with caliper or micrometer | In accordance with dimension specification. |
| 6 | Solderability | Immerse a test sample into a methanol solution containing resin and immerse into molten solder of 230 ± 5°C for 5 ± 1 second. | More than 75% of the terminal electrode part shall be covered with fresh solder. |
| 7 | Bending Strength | Solder the chip to test jig then apply a force in the direction shown in below. The soldering shall be done with the reflow method and shall be conducted with care so that the soldering is uniform and free of defects such as heat shock. Mounting Samples  | 1. No mechanical damage shall be observed. 2. Rdc-value: to meet the initial Spec. |
| 8 | Resistance to Soldering Heat | Immerse a test sample into a methanol solution containing resin, preheat it at 120 to 150°C for 1 minute and immerse into molten solder of 270 ± 5°C for 10 ± 1 second so that both terminal electrodes are completely submerged. | No visible damage. Inductance variation within 10%. Q variation within 20%. |
| 9 | Thermal Shock | Solder a test sample to printed circuit board, and conduct 5 cycles of test under the conditions shown as below. 0201 & 0402 operating temp. range: -55~125°C 0603 operating temp. range: -40~85°C Cycle: Maximum operating temp. (30 ± 3min)  Minimum operating temp. (30 ± 3min) | No visible damage. Inductance variation within 10%. Q variation within 20%. |
| 10 | High Humidity State Life Test | Keep a test sample in an atmosphere with a temperature of 40 ± 2°C, 90~95%RH for 500 ± 12 hours. After the removal from test chamber, 2 to 3 hours of recovery under standard condition, and measurement shall be made after 24 ± 2 hrs. of recovery under standard condition. | No visible damage. Inductance variation within 10%. Q variation within 20%. |
| 11 | High Humidity Load Life Test | Solder a test sample to printed circuit board then keep the test sample in an atmosphere with a temperature of 40 ± 2°C, 90~95%RH for 500 ± 12 hours while supplying the rated current. After the removal from test chamber, 2 to 3 hours of recovery under standard condition, and measurement shall be made after 24 ± 2 hrs. of recovery under standard condition. | No visible damage. Inductance variation within 10%. Q variation within 20%. |
| 12 | High Temperature State Life Test | Keep a test sample in an atmosphere with a temperature of 85 ± 2°C for 500 ± 12 hours. After the removal from test chamber, 2 to 3 hours of recovery under standard condition, and measurement shall be made after 24 ± 2 hrs. of recovery under standard condition. | No visible damage. Inductance variation within 10%. Q variation within 20%. |
| 13 | High Temperature Load | Solder a test sample to printed circuit board then keep the test sample in an atmosphere with a temperature of 85 ± 2°C for 500 ± 12 hours while supplying the rated current. After the removal from test chamber, 2 to 3 hours of recovery under standard condition, and measurement shall be made after 24 ± 2 hrs. of recovery under standard condition. | No visible damage. Inductance variation within 10%. Q variation within 20%. |

Multi-Layer High Frequency Ceramic Chip Inductors

LCMC Series

PACKAGING SPECIFICATIONS

Paper tape specification (0201/0402/0603)

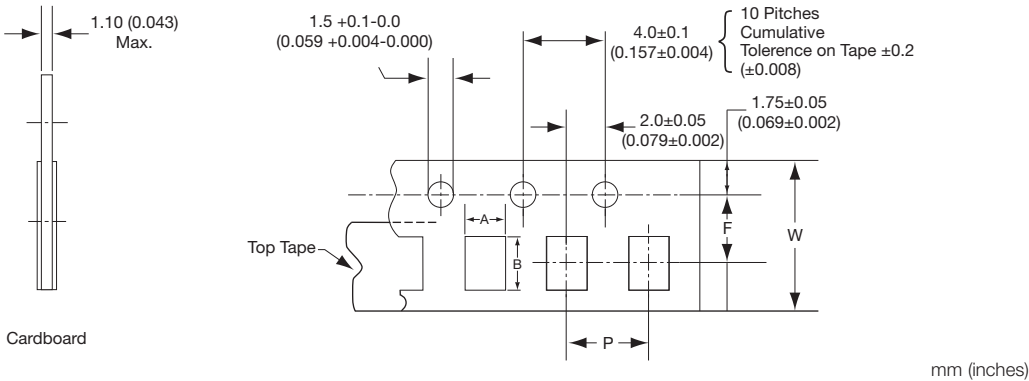

| Symbol | Product Size Code | | | | | |
|--------|-------------------|----------------|--------------|----------------|---------------|----------------|
| | 0201 | | 0402 | | 0603 | |
| | Size | Tolerance | Size | Tolerance | Size | Tolerance |
| A | 0.38 (0.015) | ± 0.02 (0.001) | 0.62 (0.024) | ± 0.03 (0.001) | 0.975 (0.038) | ± 0.05 (0.002) |
| B | 0.68 (0.027) | ± 0.02 (0.001) | 1.12 (0.044) | ± 0.03 (0.001) | 1.80 (0.071) | ± 0.05 (0.002) |
| F | 3.50 (0.138) | ± 0.05 (0.002) | 3.50 (0.138) | ± 0.05 (0.002) | 3.50 (0.138) | ± 0.05 (0.002) |
| P | 2.00 (0.079) | ± 0.10 (0.004) | 2.00 (0.079) | ± 0.10 (0.004) | 4.00 (0.157) | ± 0.10 (0.004) |
| W | 8.00 (0.315) | ± 0.20 (0.008) | 8.00 (0.315) | ± 0.20 (0.008) | 8.00 (0.315) | ± 0.20 (0.008) |

Reel Specifications

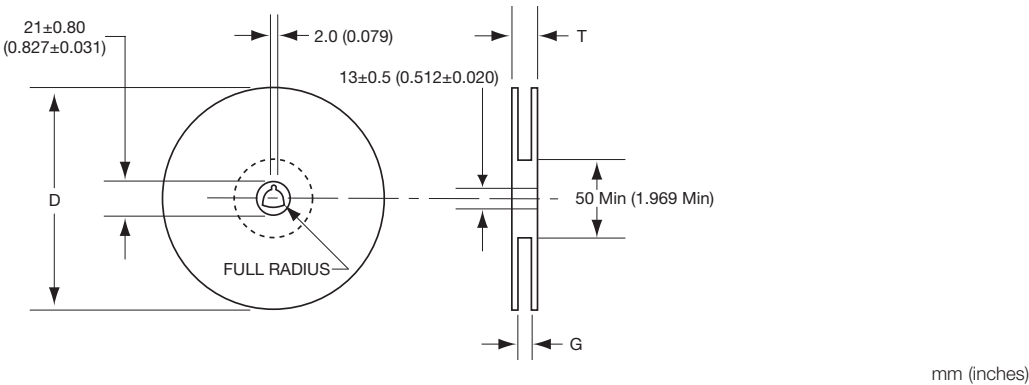

| Tape Width | G | T max. | D |
|--------------|----------------------------|--------------|-------------|
| 8.00 (0.315) | 10.0 ± 1.5 (0.394 ± 0.059) | 14.5 (0.571) | 180 (7.087) |

Peel strength of top cover tape

The peel speed shall be about 300 mm/min.
 The peel strength of top cover tape shall be between 0.1 to 1.0N.

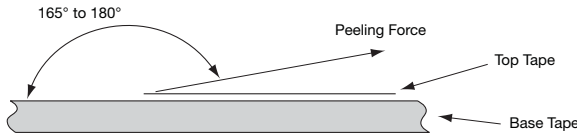

Multi-Layer High Frequency Ceramic Chip Inductors

LCMC Series

Quantity per reel

0201: 15,000 pieces / reel
 0402: 10,000 pieces / reel
 0603: 4,000 pieces / reel

The contents of a box

0201: 5 reels / box
 0402: 5 reels / box
 0603: 5 reels / box

Marking

The following item shall be marked on the reel.

- Manufactures parts number.
- Manufacturing date code.
- Manufacturer name.
- Manufactures lot number.
- Quantity.

CAUTIONS

Storage

The chip inductor shall be packaged in carrier tapes.
 To keep storage place temperature from +5 to 35°C, humidity from 45 to 70% RH.
 The storage atmosphere must be free of gas containing sulfur and chlorine. Also, avoid exposing the product to saline moisture. If the product is exposed to such atmospheres, the terminals will oxidize and solderability will be affected.
 The solderability is assured for 12 months from our final inspection date if the above storage condition is followed.

Handling

Chip inductor should be handled with care to avoid contamination or damage. The use of vacuum pick-up or plastic tweezers is recommended for manual placement. Tape and reeled packages are suitable for automatic pick and placement machine.

Recommended pad dimensions

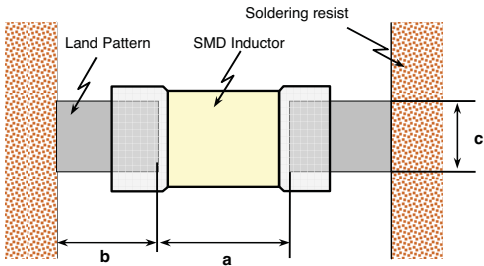

| Size (EIA) | L x W | a | b | c |
|------------|--------------------------------|----------------------------------|----------------------------------|----------------------------------|
| 0201 | 0.60 x 0.30 (0.024 x 0.012) | 0.15 to 0.35 (0.006 to 0.014) | 0.20 to 0.30 (0.008 to 0.012) | 0.25 to 0.30 (0.010 to 0.012) |
| 0402 | 1.00 x 0.50 (0.039 x 0.020) | 0.30 to 0.50 (0.012 to 0.020) | 0.35 to 0.45 (0.014 to 0.018) | 0.40 to 0.50 (0.016 to 0.020) |
| 0603 | 1.60 x 0.80 (0.063 x 0.031) | 0.70 to 1.00 (0.028 to 0.039) | 0.60 to 0.80 (0.024 to 0.031) | 0.70 to 0.80 (0.028 to 0.031) |

Soldering Profile for SMT Process with SnPb Solder Paste

The rate of preheat should not exceed 4°C/sec. and a target of 2°C/sec. is preferred. Ceramic chip components should be preheated to within 100 to 130°C of the soldering.

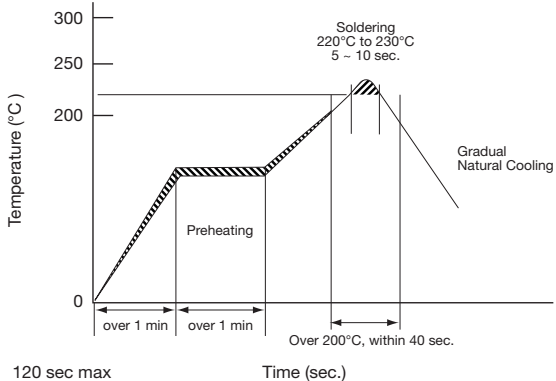

Soldering Profile for SMT Process with Lead Free Solder Paste

The rate of preheat should not exceed 4°C/sec. and a target of 2°C/sec. is preferred. Ceramic chip components should be preheated to within 100 to 130°C of the soldering.

