

Features

- Fast Read Access Time - 100 ns
- Low Power
 - 35 mA Maximum (Active)
 - 100 μ A Maximum (Standby)
- 2-V Data Retention
- Fully Static: No Clock Required
- Three Control Inputs (\overline{CE}_1 , CE_2 , and \overline{OE})
- TTL Compatible Inputs and Outputs
- 5 V \pm 10% Supply
- 28-Lead Dual In-line and Surface Mount Packages
- JEDEC Pinout
- Commercial and Industrial Temperature Ranges

Block Diagram

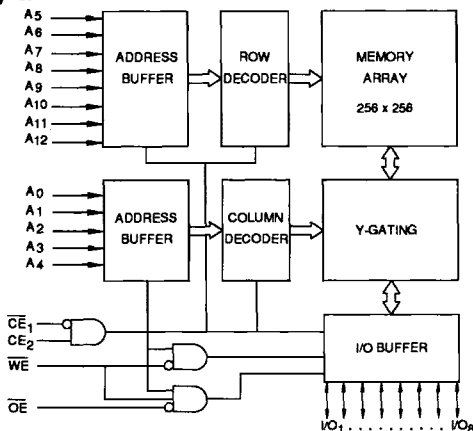

Description

The AT3864L is a high performance CMOS static Random Access Memory. Its 64K of memory is organized as 8192 words by 8 bits. Manufactured with an advanced CMOS technology, the AT3864L offers access times down to 100 ns with power dissipation of under 200 mW. When the AT3864L is deselected, the standby current is just 100 μ A. In addition, the AT3864L offers a data retention capability of only 100 μ W power dissipation when operated on a 2-volt power supply.

The AT3864L powers down to the standby mode when deselected (\overline{CE}_1 is HIGH or CE_2 is LOW). The I/O pins remain in the high impedance state unless the chip is selected (\overline{CE}_1 is LOW and CE_2 is HIGH), the outputs are enabled (\overline{OE} is LOW), and Write Enable is not active (\overline{WE} is HIGH).

The AT3864L is completely TTL compatible and requires a single 5-volt power supply. The device is fully static and does not need any clocks or refresh control signals for operation.

Pin Configurations

Pin Name	Function
A ₀ -A ₁₂	Addresses
I/O ₁ -I/O ₈	Outputs
\overline{CE}_1 , CE_2	Chip Enables
\overline{OE}	Output Enable
\overline{WE}	Write Enable
V _{cc} , GND	Power, Ground
NC	No Connect

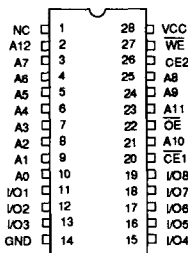

**64K (8K x 8)
CMOS
SRAM**

6





Absolute Maximum Ratings*

Temperature Under Bias.....	-40° C to 85° C
Storage Temperature.....	-55° C to 125° C
All Input Voltages (including NC Pins) with Respect to Ground	-0.3 V to V _{CC} +0.3 V
All Output Voltages with Respect to Ground	-0.3 V to V _{CC} +0.3 V
Maximum Supply Voltage	+7.0 V

*NOTICE: Stresses beyond those listed under "Absolute Maximum Ratings" may cause permanent damage to the device. This is a stress rating only and functional operation of the device at these or any other conditions beyond those indicated in the operational sections of this specification is not implied. Exposure to absolute maximum rating conditions for extended periods may affect device reliability.

Device Operation

READ: When \overline{CE}_1 is LOW, CE_2 is HIGH, \overline{OE} is LOW, and \overline{WE} is HIGH, the eight bits of data stored at the memory location determined by the address input (pins A₀ through A₁₂) are inserted on the data outputs (pins I/O₁ through I/O₈).

WRITE: When \overline{CE}_1 is LOW, CE_2 is HIGH, and \overline{WE} is LOW, the eight bits of data placed on the input pins (I/O₁ through I/O₈)

are stored at the memory location determined by the address input (pins A₀ through A₁₂).

DATA RETENTION: When the chip is in standby mode, V_{CC} can be reduced to as low as two volts without impacting data integrity. Power dissipation will be reduced to 100 μW maximum.

Operating Modes

MODE\PIN	\overline{CE}_1	CE_2	\overline{OE}	\overline{WE}	I/O
Read	L	H	L	H	DOUT
Write	L	H	X ⁽¹⁾	L	DIN
Standby ₁	H	X	X	X	High Z
Standby ₂	X	L	X	X	High Z
Output Disable	X	X	H	X	High Z

Note: 1. X can be L (Low) or H (High)

D.C. and A.C. Operating Range

		AT3864L-10	AT3864L-12	AT3864L-15
Operating Temperature (Case)	Commercial	0°C - 70°C	0°C - 70°C	0°C - 70°C
	Industrial	-40°C - 85°C	-40°C - 85°C	-40°C - 85°C
V _{CC} Power Supply		5 V ± 10%	5 V ± 10%	5 V ± 10%

D.C. and Operating Characteristics

Symbol	Parameter	Conditions	Min	Typ	Max	Units
I _{LI}	Input Load Current	V _{IN} = 0 to V _{CC}	-1.0		1.0	μA
I _{LO}	Output Leakage Current	$\overline{CE}_1 = 2.2 \text{ V to } V_{CC} + 0.3 \text{ V}$ or $\overline{CE}_2 = -0.3 \text{ V to } 0.8 \text{ V}$ or $\overline{OE} = 2.2 \text{ V to } V_{CC} + 0.3 \text{ V}$ or $\overline{WE} = -0.3 \text{ V to } 0.8 \text{ V}$ V _{I/O} = 0 to V _{CC}	-1.0		1.0	μA
I _{SB1}	Standby Current (CMOS)	CE ₂ ≤ 0.2 V or CE ₁ ≥ V _{CC} - 0.2 V, CE ₂ ≥ V _{CC} - 0.2 V or CE ₂ ≤ 0.2 V V _{IN} = 0 to V _{CC}		2	100	μA
I _{SB2}	Standby Current (TTL)	CE ₂ = -0.3 V to 0.8 V or CE ₁ = 2.2 V to V _{CC} + 0.3 V, V _{IN} = 0 to V _{CC}			3	mA
I _{CC}	V _{CC} Active Current (TTL)	$\overline{CE}_1 = -0.3 \text{ V to } 0.8 \text{ V}$, CE ₂ = 2.2 V to V _{CC} + 0.3 V, I _{OUT} = 0 mA, min cycle		20	35	mA
V _{IL}	Input Low Voltage		-0.3		0.8	V
V _{IH}	Input High Voltage		2.2 V		V _{CC} +0.3	V
V _{OL}	Output Low Voltage	I _{OL} = 2.0 mA			0.4	V
V _{OH}	Output High Voltage	I _{OH} = -1.0 mA	2.4			V

6

Pin Capacitance (f = 1 MHz, T = 25°C) ⁽¹⁾

Symbol	Parameter	Conditions	Min	Typ	Max	Units
C _{OUT}	Input/Output Capacitance	V _{OUT} = 0 V		6	10	pF
C _{IN}	Input Capacitance	V _{IN} = 0 V		6	10	pF

Note: 1. Typical values for nominal supply voltage. This parameter is only sampled and is not 100% tested.

Input Test Waveforms and Measurement Levels

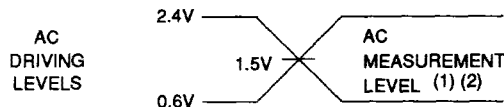

Notes: 1. Input rise and fall time 5 ns.
2. Output load: 1TTL gate + 10 pF.

A.C. Characteristics for Read

Symbol	Parameter	AT3864L-10		AT3864L-12		AT3864L-15		Units
		Min	Max	Min	Max	Min	Max	
t _{RC}	Read Cycle Time	100		120		150		ns
t _{ACC}	Address Access Time		100		120		150	ns
t _{CE1,CE2}	\overline{CE}_1, CE_2 Access Time		100		120		150	ns
t _{OE}	\overline{OE} Access Time		50		60		70	ns
t _{OH}	Output Hold Time	15		15		15		ns
t _{COE1,2}	\overline{CE}_1, CE_2 Output Enable Time	10		10		10		ns
t _{OOE}	\overline{OE} Output Enable Time	5		5		5		ns
t _{COD1,2}	\overline{CE}_1, CE_2 Output Disable Time		45		45		60	ns
t _{OOD}	\overline{OE} Output Disable Time		40		40		50	ns

A.C. Characteristics for Write

Symbol	Parameter	AT3864L-10		AT3864L-12		AT3864L-15		Units
		Min	Max	Min	Max	Min	Max	
t _{WC}	Write Cycle Time	100		120		150		ns
t _{AS}	Address Setup Time	0		0		0		ns
t _{WP}	Write Pulse Width	60		70		90		ns
t _{CW1,2}	\overline{CE}_1, CE_2 Setup Time	80		80		90		ns
t _{WR}	Write Recovery Time	0		0		0		ns
t _{WR1,2}	\overline{CE}_1, CE_2 Write Recovery Time	0		0		0		ns
t _{DS}	Data Setup Time	40		50		60		ns
t _{DH}	Data Hold Time	0		0		0		ns
t _{DH1,2}	\overline{CE}_1, CE_2 Data Hold Time	0		0		0		ns
t _{WOE}	\overline{WE} Output Enable Time	5		5		5		ns
t _{WOD}	\overline{WE} Output Disable Time		40		40		50	ns

A.C. Waveforms for Read Cycle ⁽¹⁾

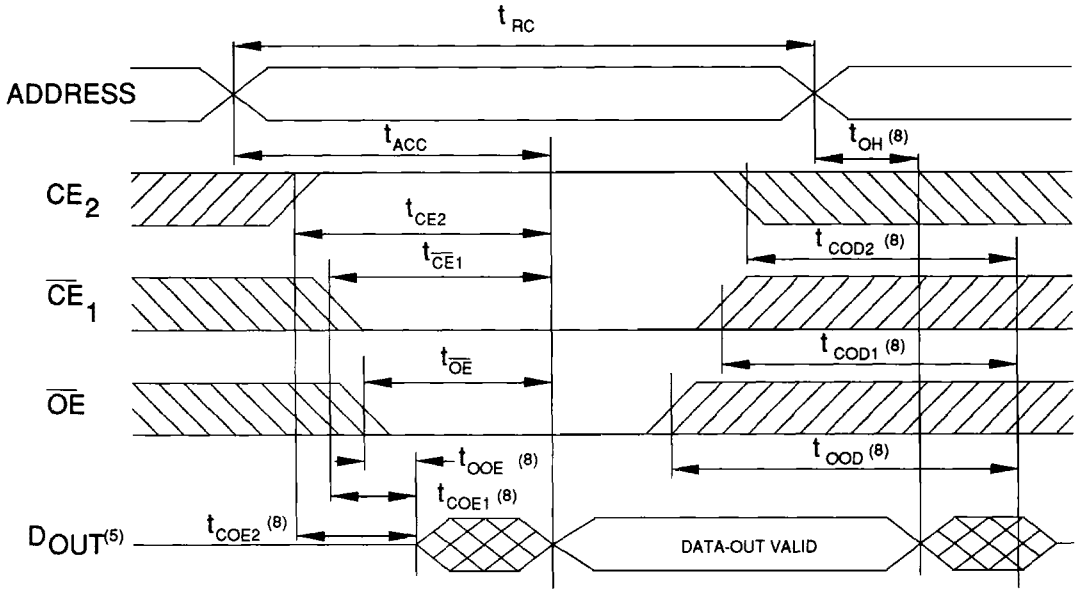

6

A.C. Waveforms for Write Cycle 1 (\overline{WE} Write) ⁽⁶⁾

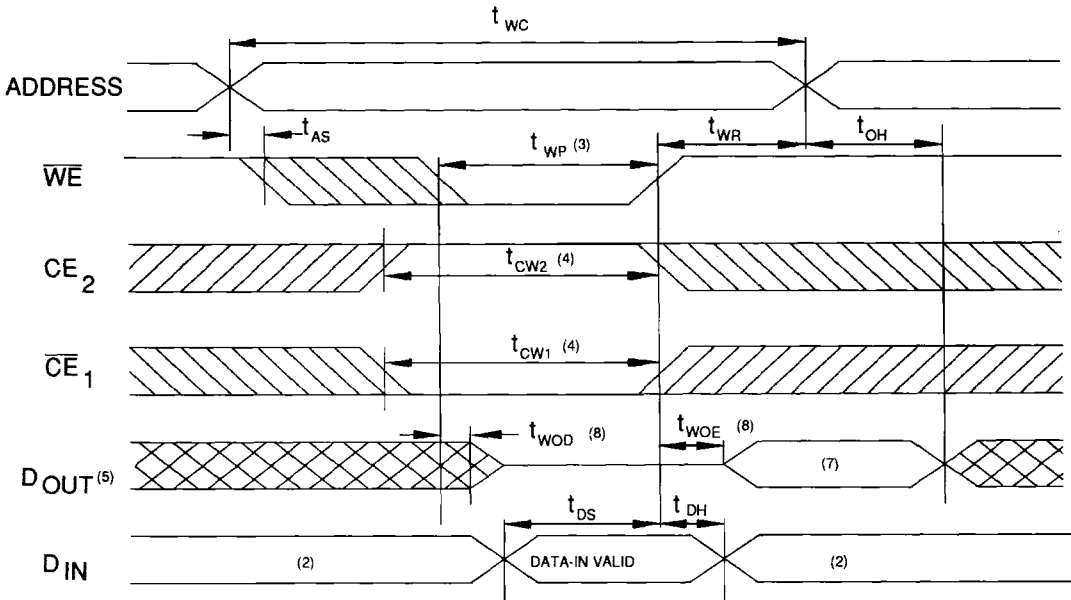

A.C. Waveforms for Write Cycle 2 (\overline{WE} Write) ⁽⁶⁾

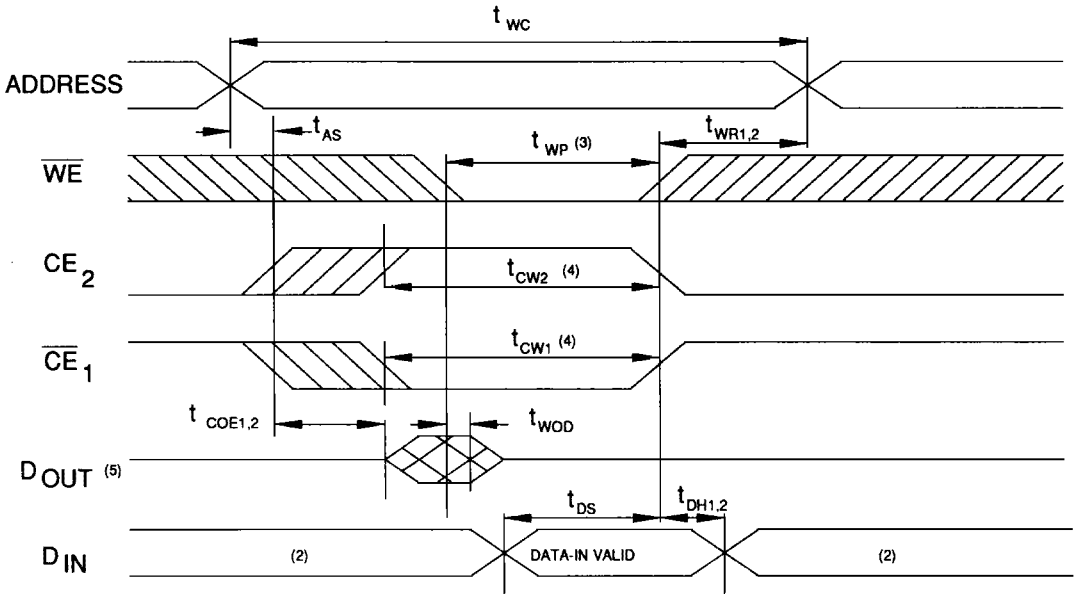

Notes:

1. During a Read Cycle, \overline{WE} should be HIGH.
2. During this period, I/O pins are in the output state.
3. A Write occurs when \overline{CE}_1 , CE_2 and \overline{WE} are all active at the same time.
A Write begins at the latest transition among \overline{CE}_1 going LOW, CE_2 going HIGH and \overline{WE} going LOW.
A Write ends at the earliest transition among \overline{CE}_1 going HIGH, CE_2 going LOW and \overline{WE} going HIGH.
 t_{wp} is measured from the beginning of Write to the end of Write.
4. t_{cw} is measured from the later of \overline{CE}_1 going LOW or CE_2 going HIGH to the end of Write.
5. If \overline{OE} or \overline{CE}_1 is HIGH, or CE_2 or \overline{WE} is LOW, D_{OUT} goes to a HIGH impedance state.
6. During a write cycle, $\overline{OE} = V_{IH}$ or V_{IL} .
7. D_{OUT} is equal to the Input Data written during the same cycle.
8. Parameter is sampled and not 100% tested.

Data Retention Characteristics

Parameter	Symbol	Conditions	Min	Typ	Max	Units
Data Retention Power Supply Voltage	VDR1	$\overline{CE}_1 \geq V_{CC} - 0.2 V$ $CE_2 \geq V_{CC} - 0.2 V$ or $CE_2 \leq 0.2 V$	2.0		5.5	V
	VDR2	$CE_2 \leq 0.2 V$	2.0		5.5	V
Data Retention Current	I _{CCDR1}	$V_{CC} = 3.0 V$ $\overline{CE}_1 \geq V_{CC} - 0.2 V$ $CE_2 \geq V_{CC} - 0.2 V$ or $CE_2 \leq 0.2 V$		1	50	μA
	I _{CCDR2}	$V_{CC} = 3.0 V$, $CE_2 \leq 0.2 V$		1	50	μA
Chip Enable Setup Time	t _{CDR}		0			ns
Chip Enable Hold Time	t _R		t _{RC} ⁽¹⁾			ns

Note: 1. t_{RC} = Read Cycle Time

6

Data Retention Waveform 1 (\overline{CE}_1 Control)

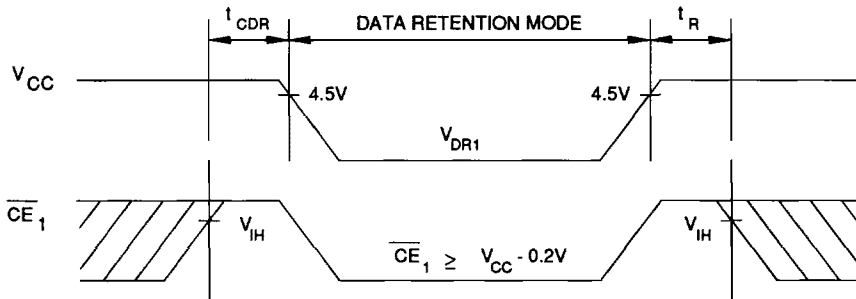

Data Retention Waveform 2 (CE₂ Control)

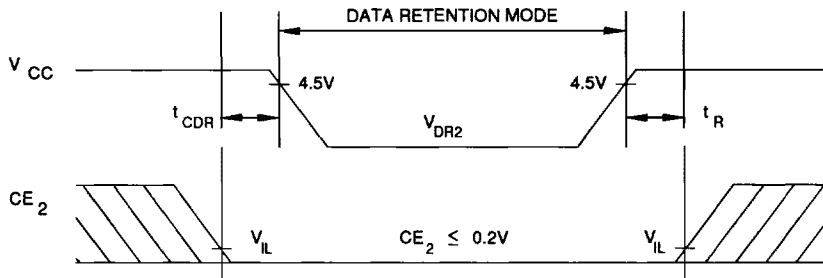



Ordering Information

t _{ACC} (ns)	I _{CC} (mA)		Ordering Code	Package	Operation Range
	Active	Standby			
100	35	0.1	AT3864L-10PC AT3864L-10RC	28P6 28R	Commercial (0° to 70°C)
			AT3864L-10PI AT3864L-10RI	28P6 28R	Industrial (-40° to 85°C)
120	35	0.1	AT3864L-12PC AT3864L-12RC	28P6 28R	Commercial (0° to 70°C)
			AT3864L-12PI AT3864L-12RI	28P6 28R	Industrial (-40° to 85°C)
150	35	0.1	AT3864L-15PC AT3864L-15RC	28P6 28R	Commercial (0° to 70°C)
			AT3864L-15PI AT3864L-15RI	28P6 28R	Industrial (-40° to 85°C)

Package Type

28P6	28 Lead, 0.600" Wide, Plastic Dual Inline Package (PDIP)
28R	28 Lead, 0.330" Wide Plastic Gull Wing Small Outline (SOIC)