

MC33272
MC33274

**Single Supply, High Slew Rate
 Low Input Offset Voltage, Bipolar
 Operational Amplifiers**

The MC33272/74 series of monolithic operational amplifiers are quality fabricated with innovative Bipolar design concepts. This dual and quad operational amplifier series incorporates Bipolar inputs along with a patented Zip-R-Trim element for input offset voltage reduction. The MC33272/74 series of operational amplifiers exhibits low input offset voltage and high gain bandwidth product. Dual-doublet frequency compensation is used to increase the slew rate while maintaining low input noise characteristics. Its all NPN output stage exhibits no deadband crossover distortion, large output voltage swing, and an excellent phase and gain margin. It also provides a low open-loop high frequency output impedance with symmetrical source and sink AC frequency performance.

The MC33272/74 series is specified over -40° to $+85^{\circ}\text{C}$ and is available in the plastic DIP and SOIC surface mount packages (P and D suffixes).

- Input Offset Voltage Trimmed to $100\ \mu\text{V}$ (Typ)
- Low Input Bias Current: $300\ \text{nA}$
- Low Input Offset Current: $3.0\ \text{nA}$
- High Input Resistance: $16\ \text{M}\Omega$
- Low Noise: $18\ \text{nV}/\sqrt{\text{Hz}}$ @ $1.0\ \text{kHz}$
- High Gain Bandwidth Product: $24\ \text{MHz}$ @ $100\ \text{kHz}$
- High Slew Rate: $10\ \text{V}/\mu\text{s}$
- Power Bandwidth: $160\ \text{kHz}$
- Excellent Frequency Stability
- Unity Gain Stable: w/Capacitance Loads to $500\ \text{pF}$
- Large Output Voltage Swing: $+14.1\ \text{V}/-14.6\ \text{V}$
- Low Total Harmonic Distortion: 0.003%
- Power Supply Drain Current: $2.15\ \text{mA}$ per Amplifier
- Single or Split Supply Operation: $+3.0\ \text{V}$ to $+36\ \text{V}$ or $\pm 1.5\ \text{V}$ to $\pm 18\ \text{V}$
- ESD Diodes Provide Added Protection to the Inputs

ORDERING INFORMATION

Op Amp Function	Device	Specified Ambient Temperature Range	Package
Dual	MC33272D	-40° to $+85^{\circ}\text{C}$	SO-8
	MC33272P		Plastic DIP
Quad	MC33274D		SO-14
	MC33274P		Plastic DIP

**HIGH PERFORMANCE
 OPERATIONAL
 AMPLIFIERS**

**SILICON MONOLITHIC
 INTEGRATED CIRCUIT**

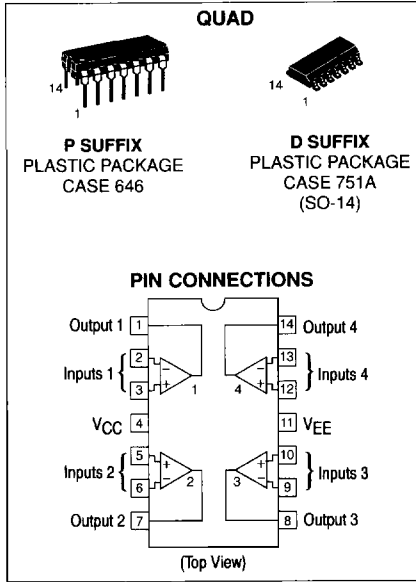
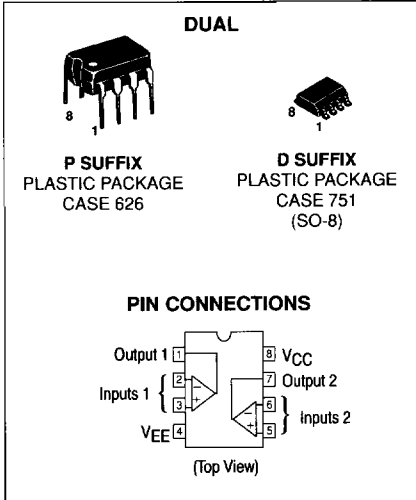

MC33272, MC33274

2

MAXIMUM RATINGS

Rating	Symbol	Value	Unit
Supply Voltage	V_{CC} to V_{EE}	+36	V
Input Differential Voltage Range	V_{IDR}	(Note 1)	V
Input Voltage Range	V_{IR}	(Note 1)	V
Output Short Circuit Duration (Note 2)	t_{SC}	Indefinite	sec
Maximum Junction Temperature	T_J	+150	°C
Storage Temperature	T_{stg}	-60 to +150	°C
Maximum Power Dissipation	P_D	(Note 2)	mW

- NOTES:**
- Either or both input voltages should not exceed V_{CC} or V_{EE} .
 - Power dissipation must be considered to ensure maximum junction temperature (T_J) is not exceeded (see Figure 2).

DC ELECTRICAL CHARACTERISTICS ($V_{CC} = +15$ V, $V_{EE} = -15$ V, $T_A = 25^\circ\text{C}$, unless otherwise noted.)

Characteristics	Figure	Symbol	Min	Typ	Max	Unit
Input Offset Voltage ($R_S = 10 \Omega$, $V_{CM} = 0$ V, $V_O = 0$ V) ($V_{CC} = +15$ V, $V_{EE} = -15$ V) $T_A = +25^\circ\text{C}$ $T_A = -40^\circ$ to $+85^\circ\text{C}$ ($V_{CC} = 5.0$ V, $V_{EE} = 0$) $T_A = +25^\circ\text{C}$	3	$ V_{IO} $	—	0.1	1.0	mV
Average Temperature Coefficient of Input Offset Voltage $R_S = 10 \Omega$, $V_{CM} = 0$ V, $V_O = 0$ V, $T_A = -40^\circ$ to $+85^\circ\text{C}$	3	$\Delta V_{IO}/\Delta T$	—	2.0	—	$\mu\text{V}/^\circ\text{C}$
Input Bias Current ($V_{CM} = 0$ V, $V_O = 0$ V) $T_A = +25^\circ\text{C}$ $T_A = -40^\circ$ to $+85^\circ\text{C}$	4, 5	I_{IB}	—	300	650	nA
Input Offset Current ($V_{CM} = 0$ V, $V_O = 0$ V) $T_A = +25^\circ\text{C}$ $T_A = -40^\circ$ to $+85^\circ\text{C}$		$ I_{IO} $	—	3.0	65	nA
Common Mode Input Voltage Range ($\Delta V_{IO} = 5.0$ mV, $V_O = 0$ V) $T_A = +25^\circ\text{C}$	6	V_{ICR}	V_{EE} to $(V_{CC} - 1.8)$			V
Large Signal Voltage Gain ($V_O = 0$ V to 10 V, $R_L = 2.0$ k Ω) $T_A = +25^\circ\text{C}$ $T_A = -40^\circ$ to $+85^\circ\text{C}$	7	A_{VOL}	90 86	100	—	dB
Output Voltage Swing ($V_{ID} = \pm 1.0$ V) ($V_{CC} = +15$ V, $V_{EE} = -15$ V) $R_L = 2.0$ k Ω $R_L = 2.0$ k Ω $R_L = 10$ k Ω $R_L = 10$ k Ω ($V_{CC} = 5.0$ V, $V_{EE} = 0$ V) $R_L = 2.0$ k Ω $R_L = 2.0$ k Ω	8, 9, 12 10, 11	V_{O+} V_{O-} V_{O+} V_{O-} V_{OL} V_{OH}	13.4 — 13.4 —	13.9 -13.9 14 -14.7	— -13.5 — -14.1	V
Common Mode Rejection ($V_{in} = +13.2$ V to -15 V)	13	CMR	80	100	—	dB
Power Supply Rejection $V_{CC}/V_{EE} = +15$ V/ -15 V, $+5.0$ V/ -15 V, $+15$ V/ -5.0 V	14, 15	PSR	80	105	—	dB
Output Short Circuit Current ($V_{ID} = 1.0$ V, Output to Ground) Source Sink	16	I_{SC}	+25 -25	+37 -37	—	mA
Power Supply Current Per Amplifier ($V_O = 0$ V) ($V_{CC} = +15$ V, $V_{EE} = -15$ V) $T_A = +25^\circ\text{C}$ $T_A = -40^\circ$ to $+85^\circ\text{C}$ ($V_{CC} = 5.0$ V, $V_{EE} = 0$ V) $T_A = +25^\circ\text{C}$	17	I_{CC}	—	2.15	2.75	mA
			—	—	3.0	
			—	—	2.75	

MC33272, MC33274

2

AC ELECTRICAL CHARACTERISTICS ($V_{CC} = +15\text{ V}$, $V_{EE} = -15\text{ V}$, $T_A = 25^\circ\text{C}$, unless otherwise noted.)

Characteristics	Figure	Symbol	Min	Typ	Max	Unit
Slew Rate ($V_{in} = -10\text{ V}$ to $+10\text{ V}$, $R_L = 2.0\text{ k}\Omega$, $C_L = 100\text{ pF}$, $A_V = +1.0\text{ V}$)	18, 33	SR	8.0	10	—	V/ μs
Gain Bandwidth Product ($f = 100\text{ kHz}$)	19	GBW	17	24	—	MHz
AC Voltage Gain ($R_L = 2.0\text{ k}\Omega$, $V_O = 0\text{ V}$, $f = 20\text{ kHz}$)	20, 21, 22	A_{VO}	—	65	—	dB
Unity Gain Frequency (Open-Loop)		f_U	—	5.5	—	MHz
Gain Margin ($R_L = 2.0\text{ k}\Omega$, $C_L = 0\text{ pF}$)	23, 24, 26	A_m	—	12	—	dB
Phase Margin ($R_L = 2.0\text{ k}\Omega$, $C_L = 0\text{ pF}$)	23, 25, 26	ϕ_m	—	55	—	Degrees
Channel Separation ($f = 20\text{ Hz}$ to 20 kHz)	27	CS	—	-120	—	dB
Power Bandwidth ($V_O = 20\text{ V}_{p-p}$, $R_L = 2.0\text{ k}\Omega$, $\text{THD} \leq 1.0\%$)		BWP	—	160	—	kHz
Total Harmonic Distortion ($R_L = 2.0\text{ k}\Omega$, $f = 20\text{ Hz}$ to 20 kHz , $V_O = 3.0\text{ V}_{rms}$, $A_V = +1.0$)	28	THD	—	0.003	—	%
Open-Loop Output Impedance ($V_O = 0\text{ V}$, $f = 6.0\text{ MHz}$)	29	$ Z_O $	—	35	—	Ω
Differential Input Resistance ($V_{CM} = 0\text{ V}$)		R_{IN}	—	16	—	M Ω
Differential Input Capacitance ($V_{CM} = 0\text{ V}$)		C_{IN}	—	3.0	—	pF
Equivalent Input Noise Voltage ($R_S = 100\ \Omega$, $f = 1.0\text{ kHz}$)	30	e_n	—	18	—	nV/ $\sqrt{\text{Hz}}$
Equivalent Input Noise Current ($f = 1.0\text{ kHz}$)	31	i_n	—	0.5	—	pA/ $\sqrt{\text{Hz}}$

Figure 1. Equivalent Circuit Schematic (Each Amplifier)

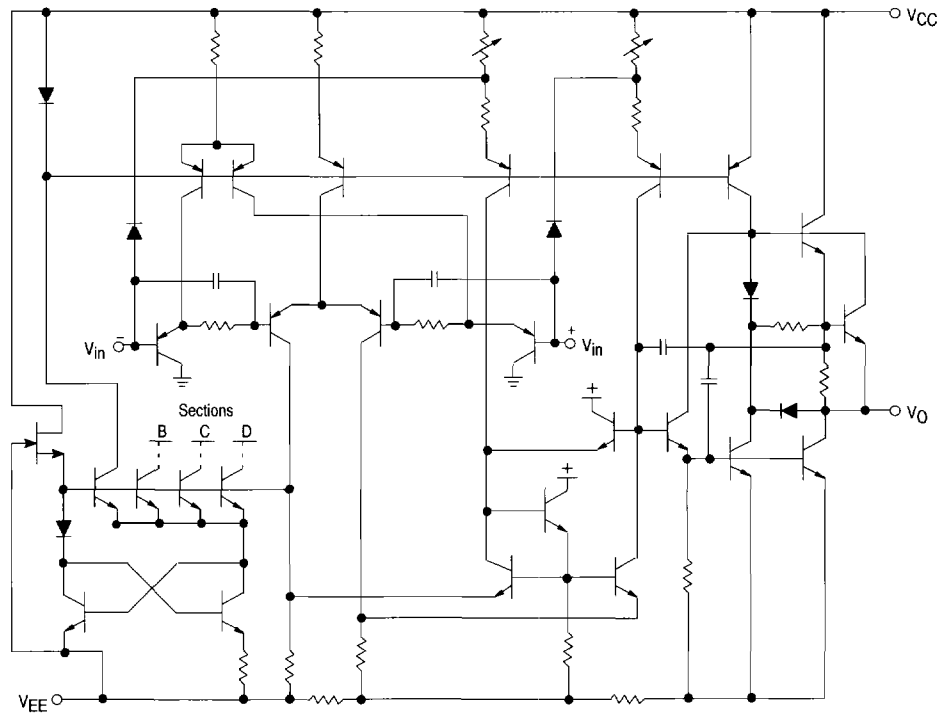

MC33272, MC33274

2

Figure 2. Maximum Power Dissipation versus Temperature

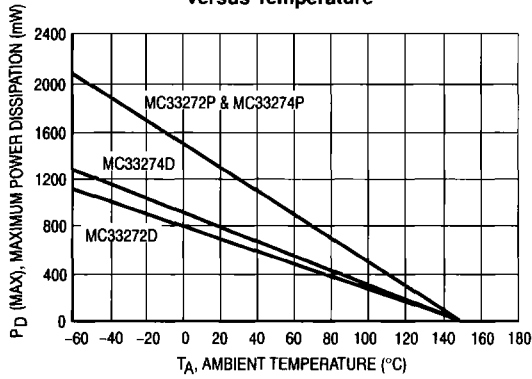

Figure 3. Input Offset Voltage versus Temperature for Typical Units

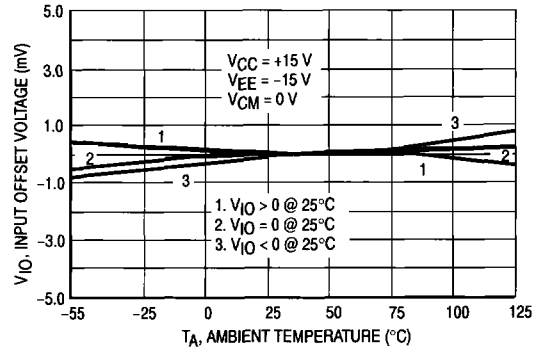

Figure 4. Input Bias Current versus Common Mode Voltage

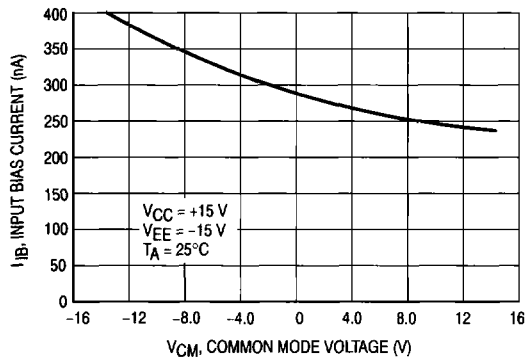

Figure 5. Input Bias Current versus Temperature

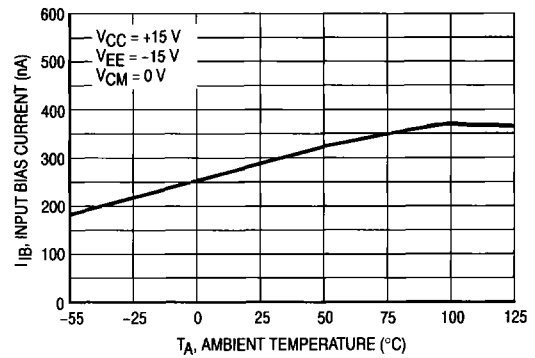

Figure 6. Input Common Mode Voltage Range versus Temperature

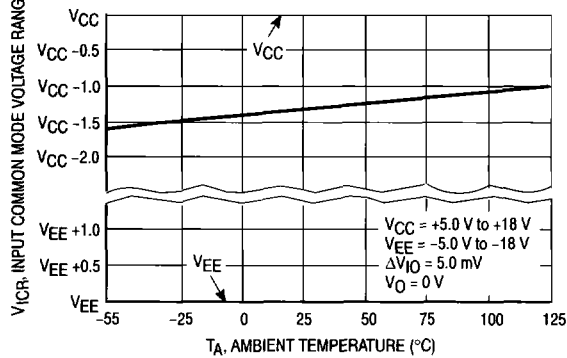

Figure 7. Open-Loop Voltage Gain versus Temperature

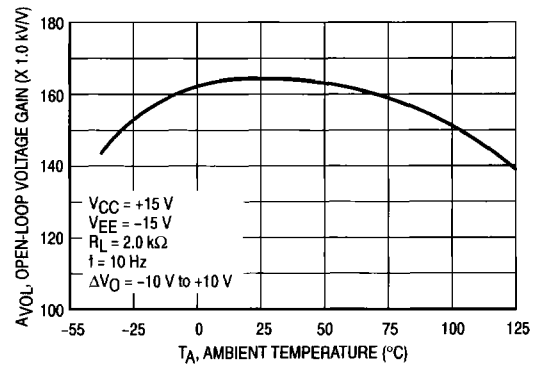

Figure 8. Split Supply Output Voltage Swing versus Supply Voltage

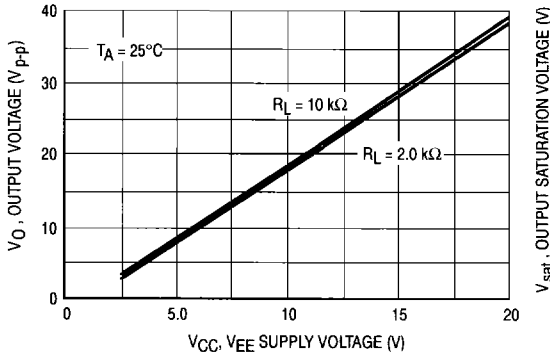

Figure 9. Split Supply Output Saturation Voltage versus Load Current

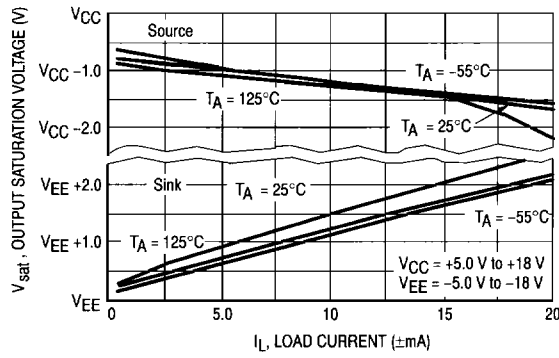

Figure 10. Single Supply Output Saturation Voltage versus Load Resistance to Ground

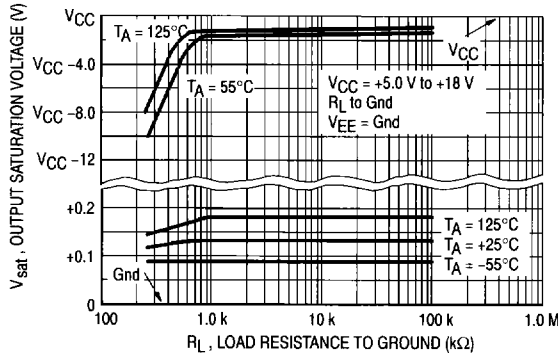

Figure 11. Single Supply Output Saturation Voltage versus Load Resistance to VCC

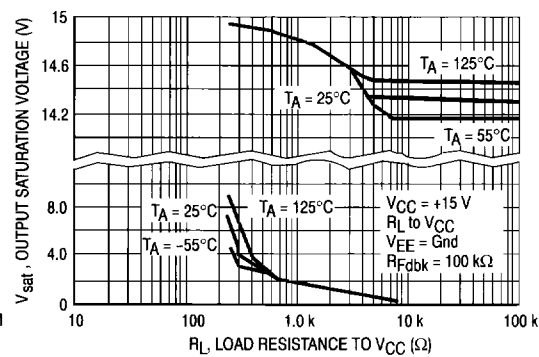

Figure 12. Output Voltage versus Frequency

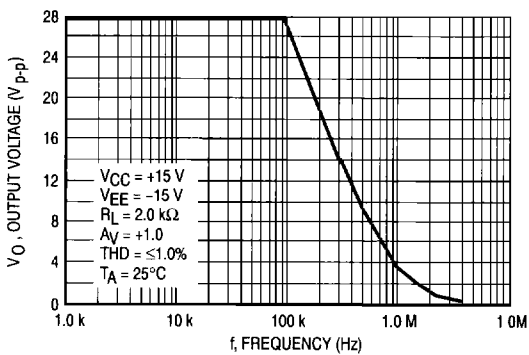
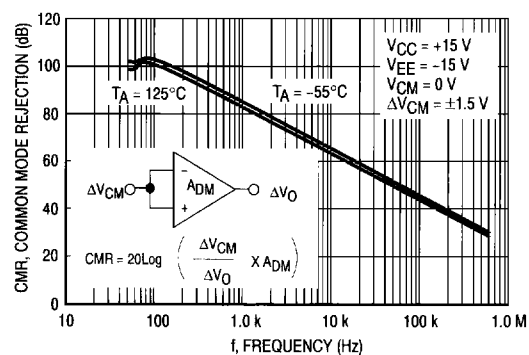

Figure 13. Common Mode Rejection versus Frequency



2

Figure 14. Positive Power Supply Rejection versus Frequency

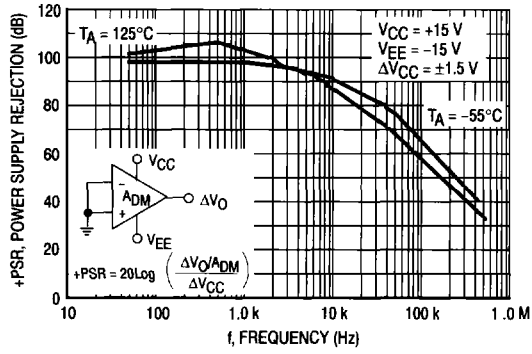

Figure 15. Negative Power Supply Rejection versus Frequency

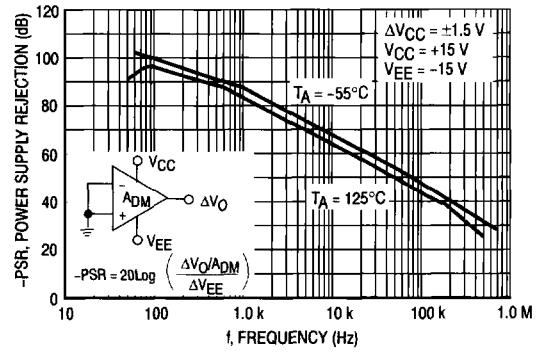

Figure 16. Output Short Circuit Current versus Temperature

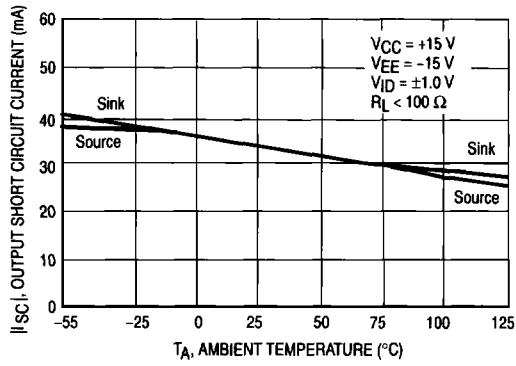

Figure 17. Supply Current versus Supply Voltage

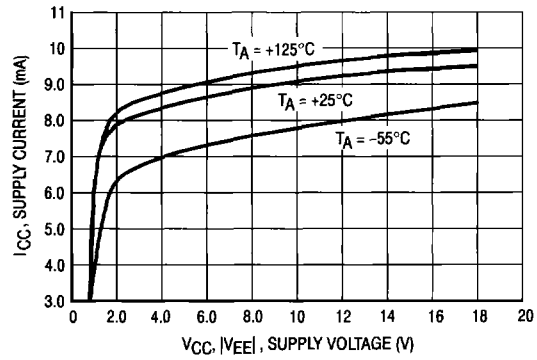

Figure 18. Normalized Slew Rate versus Temperature

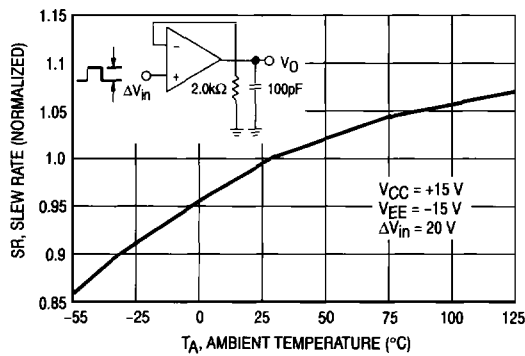

Figure 19. Gain Bandwidth Product versus Temperature

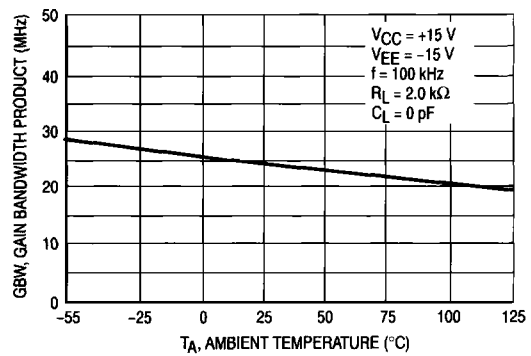

Figure 20. Voltage Gain and Phase versus Frequency

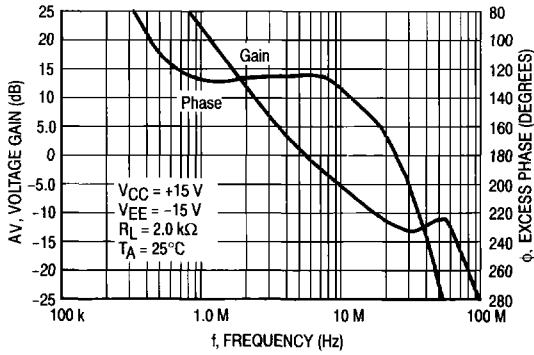

Figure 21. Gain and Phase versus Frequency

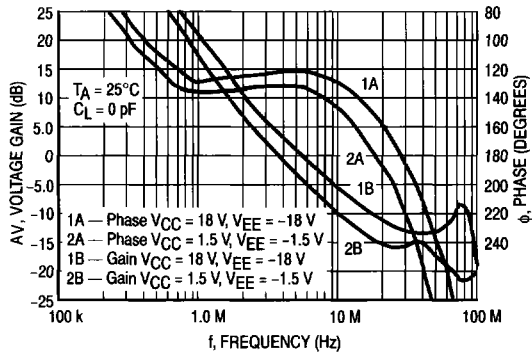

Figure 22. Open-Loop Voltage Gain and Phase versus Frequency

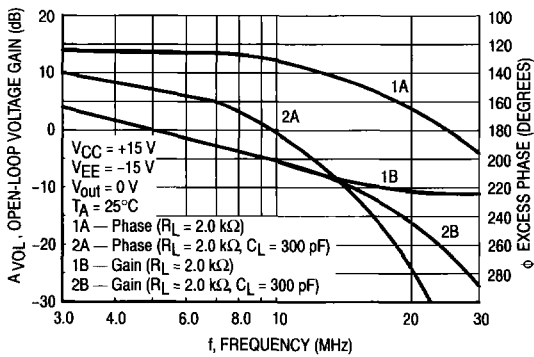

Figure 23. Open-Loop Gain Margin and Phase Margin versus Output Load Capacitance

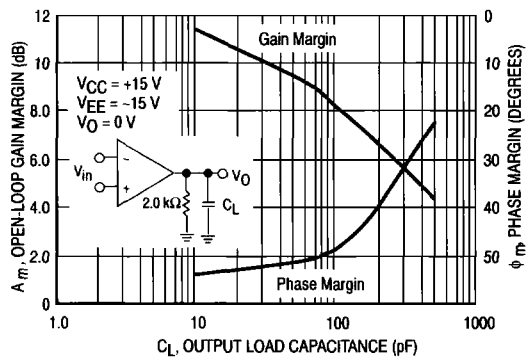

Figure 24. Open-Loop Gain Margin versus Temperature

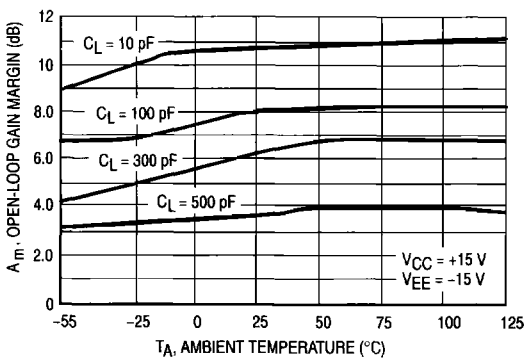

Figure 25. Phase Margin versus Temperature

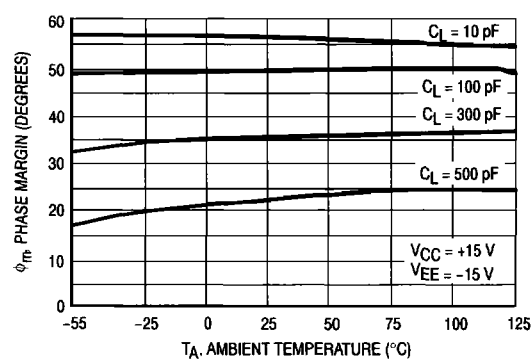

Figure 26. Phase Margin and Gain Margin versus Differential Source Resistance

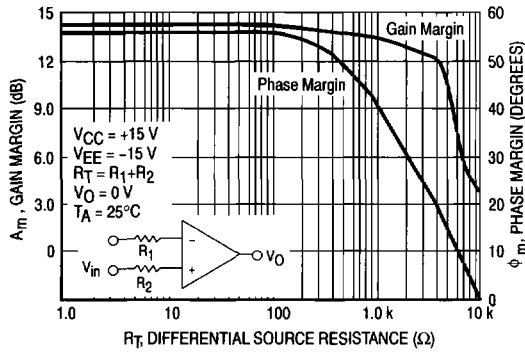

Figure 27. Channel Separation versus Frequency

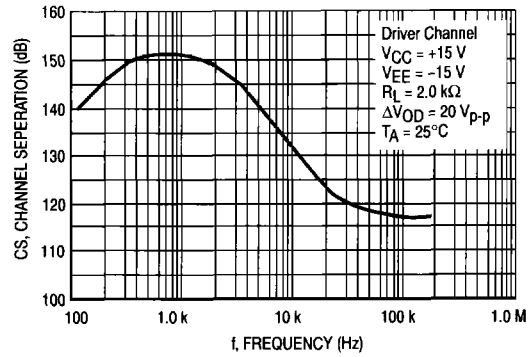

Figure 28. Total Harmonic Distortion versus Frequency

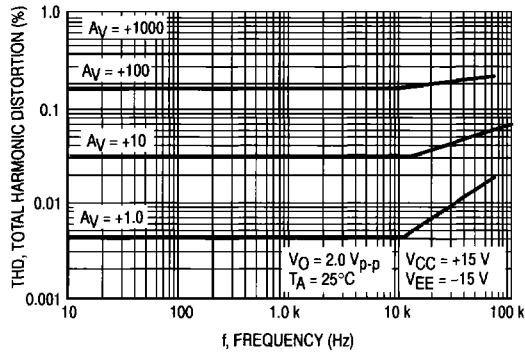

Figure 29. Output Impedance versus Frequency

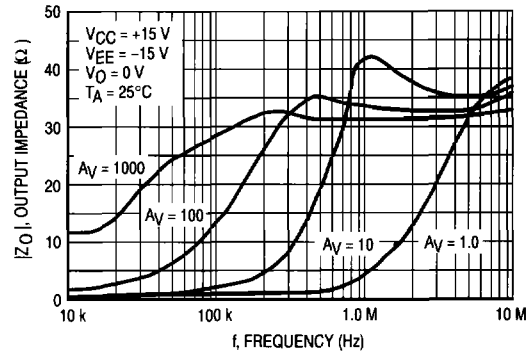

Figure 30. Input Referred Noise Voltage versus Frequency

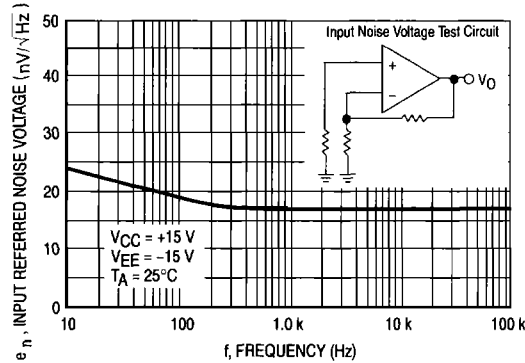
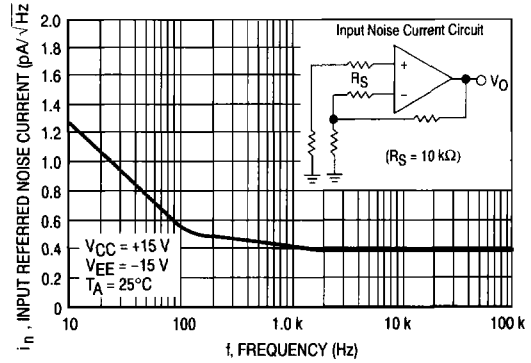

Figure 31. Input Referred Noise Current versus Frequency



MC33272, MC33274

Figure 32. Percent Overshoot versus Load Capacitance

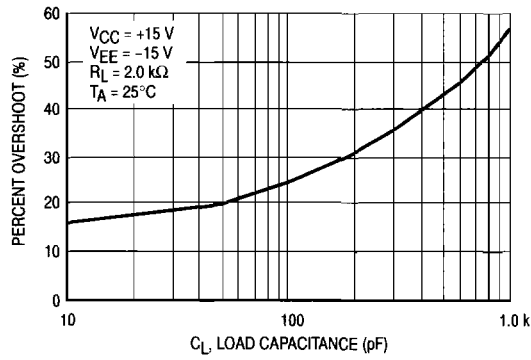

Figure 33. Noninverting Amplifier Slew Rate for the MC33274

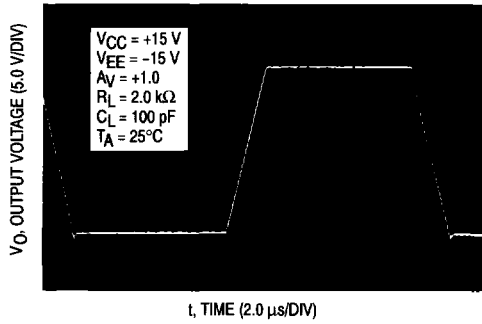

Figure 34. Noninverting Amplifier Overshoot for the MC33274

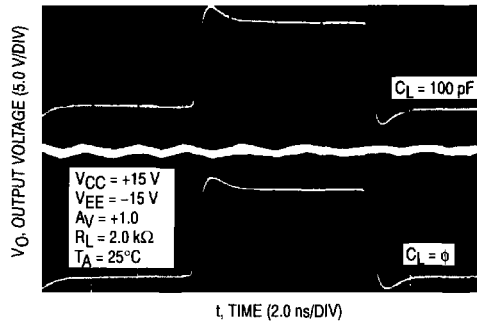

Figure 35. Small Signal Transient Response for MC33274

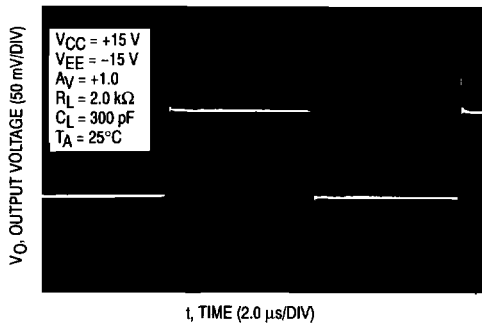

Figure 36. Large Signal Transient Response for MC33274

