

Solid Tantalum Chip Capacitors MICROTAN™ Leadframeless Molded

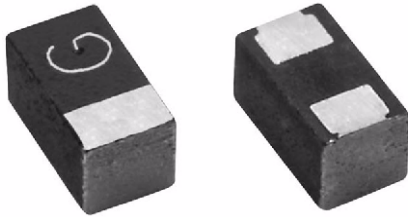

FEATURES

- Small sizes include 0603 and 0402 footprint
- Lead (Pb)-free L-shaped terminations
- 8 mm tape and reel packaging available per EIA-481-1 and reeling per IEC 286-3 7" [178 mm] standard
- Compliant to RoHS directive 2002/95/EC



PERFORMANCE CHARACTERISTICS

Operating Temperature: - 55 °C to + 85 °C
(to + 125 °C voltage derating)

Capacitance Range: 1 μF to 220 μF

Capacitance Tolerance: ± 20 % standard

Voltage Range: 2.5 WV_{DC} to 50 WV_{DC}

ORDERING INFORMATION						
298D	106	X0	010	M	2	T
MODEL	CAPACITANCE	CAPACITANCE TOLERANCE	DC VOLTAGE RATING AT + 85 °C	CASE CODE	TERMINATION	REEL SIZE AND PACKAGING
	This is expressed in picofarads. The first two digits are the significant figures. The third is the number of zeros to follow.	X0 = ± 20 % X9 = ± 10 %	This is expressed in volts. To complete the three-digit block, zeros precede the voltage rating. A decimal point is indicated by an "R" (6R3 = 6.3 V).	See Ratings and Case Codes table	2 = 100 % tin 4 = Gold plated	T = Tape and reel 7" [178 mm] reel

Note

- Preferred tolerance and reel size are in bold.
- We reserve the right to supply higher voltage ratings and tighter capacitance tolerance capacitors in the same case size.
- Voltage substitutions will be marked with the higher voltage rating

DIMENSIONS in inches [millimeters]						
CASE	L	W	H	P1	P2 (REF.)	C
K	0.039 ± 0.008 [1.0 ± 0.2]	0.02 ± 0.008 [0.5 ± 0.2]	0.024 max. [0.6 max.]	0.01 ± 0.004 [0.25 ± 0.1]	0.02 [0.5]	0.015 ± 0.004 [0.38 ± 0.1]
M	0.063 ± 0.004 [1.60 ± 0.1]	0.033 ± 0.004 [0.85 ± 0.1]	0.031 ± 0.004 [0.80 ± 0.1]	0.020 ± 0.004 [0.50 ± 0.1]	0.024 [0.60]	0.024 ± 0.004 [0.60 ± 0.1]
R	0.079 ± 0.004 [2.0 ± 0.1]	0.050 ± 0.004 [1.25 ± 0.1]	0.060 max. [1.5 max.]	0.020 ± 0.004 [0.50 ± 0.1]	0.04 [1.0]	0.035 ± 0.004 [0.90 ± 0.1]
P	0.094 ± 0.004 [2.4 ± 0.1]	0.057 ± 0.004 [1.45 ± 0.1]	0.043 ± 0.004 [1.10 ± 0.1]	0.020 ± 0.004 [0.50 ± 0.1]	0.057 [1.40]	0.035 ± 0.004 [0.90 ± 0.1]
A	0.126 ± 0.008 [3.2 ± 0.2]	0.063 ± 0.008 [1.6 ± 0.2]	0.063 ± 0.008 [1.6 ± 0.2]	0.031 ± 0.004 [0.80 ± 0.1]	0.063 [1.60]	0.047 ± 0.004 [1.20 ± 0.1]

** Please see document "Vishay Material Category Policy" (5-2008): www.vishay.com/doc?99902

RATINGS AND CASE CODES									
μF	2.5 V	4 V	6.3 V	10 V	16 V	20 V	25 V	35 V	50 V
1.0			K	K	K/M		M/R		P
1.5				M					
2.2			K/M	K/M	M				
3.3			M	M					
4.7		K	K*/M	M	M	P	P		
6.8									
10		K/M	K*/M	M	R				
15		K	M	M					
22		M	M	M					
33		M	M	P					
47	M	M	P	P					
100		P	P/A*						
220	P	P							

Note

* Preliminary values, contact factory for availability.

MARKING					
	M-CASE		P, R-CASE		
	V	CODE	CAP, F	CODE	
	2.5	e	0.68	w	
	4	G	1	A	
	6.3	J	2.2	J	
	10	A	3.3	N	
	16	C	4.7	S	
	20	D	6.8	W	
	25	E	10	α	
	35	V	15	e	
	50	T	22	j	
				33	n
			47	s	
			68	w	
			100	Ā	
			150	Ē	
			220	J	

STANDARD RATINGS							
CAPACITANCE (μF)	CASE CODE	PART NUMBER	MAX. DC LEAKAGE AT + 25 °C (μA)	MAX. DF AT + 25 °C (%)	MAX. ESR AT + 25 °C 100 kHz (Ω)	MAX. RIPPLE 100 kHz I _{rms} (A)	ΔC/C ⁽¹⁾ (%)
2.5 WV_{DC} AT + 85 °C, ... 1.6 WV_{DC} AT + 125 °C							
47	M	298D476X02R5M2T	2.4	20	4.0	0.080	± 30
220	P	298D227X02R5P2T	11.0	30	3.0	0.122	± 30
4 WV_{DC} AT + 85 °C, ... 2.7 WV_{DC} AT + 125 °C							
4.7	K	298D475X0004K2T	0.5	15.0	20.0	0.027	± 30
10	K	298D106X0004K2T	4.0	50.0	20.0	0.027	± 30
10	M	298D106X0004M2T	0.5	8.0	5.0	0.071	± 10
15	K	298D156X0004K2T	10.0	50.0	20.0	0.027	± 30
22	M	298D226X0004M2T	0.9	15.0	4.0	0.080	± 15
33	M	298D336X0004M2T	2.6	30.0	4.0	0.080	± 20
47	M	298D476X0004M2T	3.8	40.0	7.5	0.080	± 30
100	P	298D107X0004P2T	4.0	30.0	2.0	0.100	± 30
220	P	298D227X0004P2T ⁽³⁾	17.6	30.0	3.0	0.122	± 30

STANDARD RATINGS							
CAPACITANCE (μ F)	CASE CODE	PART NUMBER	MAX. DC LEAKAGE AT + 25 °C (μ A)	MAX. DF AT + 25 °C (%)	MAX. ESR AT + 25 °C 100 kHz (Ω)	MAX. RIPPLE 100 kHz I_{rms} (A)	$\Delta C/C$ ⁽¹⁾ (%)
6.3 WV_{DC} AT + 85 °C, . . . 4 WV_{DC} AT + 125 °C							
1.0	K	298D105X06R3K2T	0.5	6.0	20.0	0.027	± 30
2.2	K	298D225X06R3K2T	0.5	8.0	20.0	0.027	± 30
2.2	M	298D225X06R3M2T ⁽³⁾	0.5	10.0	5.0	0.070	± 10
3.3	M	298D335X06R3M2T ⁽³⁾	0.5	8.0	6.0	0.090	
4.7	K	298D475X06R3K2T ⁽²⁾	4.0	50.0	20.0	0.027	± 30
4.7	M	298D475X06R3M2T ⁽²⁾	0.5	8.0	3.0	0.090	± 10
10	K	298D106X06R3K2T ⁽²⁾	10.0	50.0	20.0	0.027	± 30
10	M	298D106X06R3M2T ⁽³⁾	0.6	8.0	5.0	0.071	± 10
15	M	298D156X06R3M2T ⁽³⁾	1.0	20.0	7.0	0.060	± 20
22	M	298D226X06R3M2T	2.8	20.0	5.5	0.067	± 15
33	M	298D336X06R3M2T	4.2	30.0	7.5	0.058	± 30
47	P	298D476X06R3P2T	3.0	22.0	3.0	0.122	± 20
100	A	298D107X06R3A2T ⁽²⁾	6.3	20.0	1.0	0.270	± 10
100	P	298D107X06R3P2T	6.3	30.0	2.0	0.150	± 20
10 WV_{DC} AT + 85 °C, . . . 7 WV_{DC} AT + 125 °C							
1.0	K	298D105X0010K2T	0.5	6.0	20.0	0.027	± 30
1.5	M	298D155X0010M2T ⁽³⁾	0.5	6.0	14.0	0.040	
2.2	K	298D225X0010K2T	0.5	8.0	15.0	0.027	± 30
2.2	M	298D225X0010M2T	0.5	10.0	10.0	0.050	± 10
3.3	M	298D335X0010M2T ⁽³⁾	0.5	8.0	6.0	0.090	
4.7	M	298D475X0010M2T ⁽³⁾	0.5	6.0	5.0	0.071	± 15
10	M	298D106X0010M2T	1.0	20.0	7.5	0.058	± 15
15	M	298D156X0010M2T ⁽³⁾	1.5	30.0	7.5	0.058	± 20
22	M	298D226X0010M2T	22.0	40.0	10.0	0.050	± 30
33	P	298D336X0010P2T ⁽³⁾	3.3	16.0	2.0	0.150	± 10
47	P	298D476X0010P2T	4.7	22.0	3.0	0.122	± 20
16 WV_{DC} AT + 85 °C, . . . 10 WV_{DC} AT + 125 °C							
1.0	K	298D105X0016K2T	3.0	10.0	20.0	0.027	± 30
1.0	M	298D105X0016M2T ⁽³⁾	0.5	6.0	12.0	0.045	± 15
2.2	M	298D225X0016M2T ⁽³⁾	0.5	10.0	12.0	0.045	± 15
4.7	M	298D475X0016M2T	0.8	8.0	6.0	0.060	± 15
10	R	298D106X0016R2T	1.6	8.0	8.0	0.075	± 10
20 WV_{DC} AT + 85 °C, . . . 13 WV_{DC} AT + 125 °C							
4.7	P	298D475X0020P2T ⁽³⁾	1.0	6.0	4.0	0.106	± 10
25 WV_{DC} AT + 85 °C, . . . 17 WV_{DC} AT + 125 °C							
1.0	M	298D105X0025M2T	0.5	6.0	10.0	0.050	± 10
1.0	R	298D105X0025R2T	0.5	6.0	10.0	0.050	± 10
4.7	P	298D475X0025P2T ⁽³⁾	1.2	6.0	4.0	0.106	± 10
50 WV_{DC} AT + 85 °C, . . . 33 WV_{DC} AT + 125 °C							
1.0	P	298D105X0050P2T	0.5	8.0	8.0	0.075	± 10

Notes

- (1) See Performance Characteristics tables
 (2) In development
 (3) ± 10 % capacitance tolerance available



Solid Tantalum Chip Capacitors
MICROTAN™ Leadframeless Molded

Vishay Sprague

CAPACITORS PERFORMANCE CHARACTERISTICS

ELECTRICAL PERFORMANCE CHARACTERISTICS				
ITEM	PERFORMANCE CHARACTERISTICS			
Category Temperature Range	- 55 °C to + 85 °C (to + 125 °C with voltage derating)			
Capacitance Tolerance	± 20 %, ± 10 % (at 120 Hz) 2 V _{rms} at + 25 °C using a capacitance bridge			
Dissipation Factor (at 120 Hz)	Limits per Standard Ratings Table. Tested via bridge method, at 25 °C, 120 Hz.			
ESR (100 kHz)	Limits per Standard Ratings Table. Tested via bridge method, at 25 °C, 100 kHz.			
Leakage Current	After application of rated voltage applied to capacitors for 5 minutes using a steady source of power with 1 kΩ resistor in series with the capacitor under test, leakage current at 25 °C is not more than described in Standard Ratings Table. Note that the leakage current varies with temperature and applied voltage. See graph below for the appropriate adjustment factor.			
Reverse Voltage	Capacitors are capable of withstanding peak voltages in the reverse direction equal to: 10 % of the DC rating at + 25 °C 5 % of the DC rating at + 85 °C Vishay does not recommend intentional or repetitive application of reverse voltage			
Temperature Derating	If capacitors are to be used at temperatures above + 25 °C, the permissible rms ripple current or voltage shall be calculated using the derating factors: 1.0 at + 25 °C 0.9 at + 85 °C 0.4 at + 125 °C			
Operating Temperature	+ 85 °C RATING		+ 125 °C RATING	
	WORKING VOLTAGE (V)	SURGE VOLTAGE (V)	WORKING VOLTAGE (V)	SURGE VOLTAGE (V)
	4	5.2	2.7	3.4
	6.3	8	4	5
	10	13	7	8
	16	20	10	12
	20	26	13	16
	25	32	17	20
	35	46	23	28
50	65	33	40	

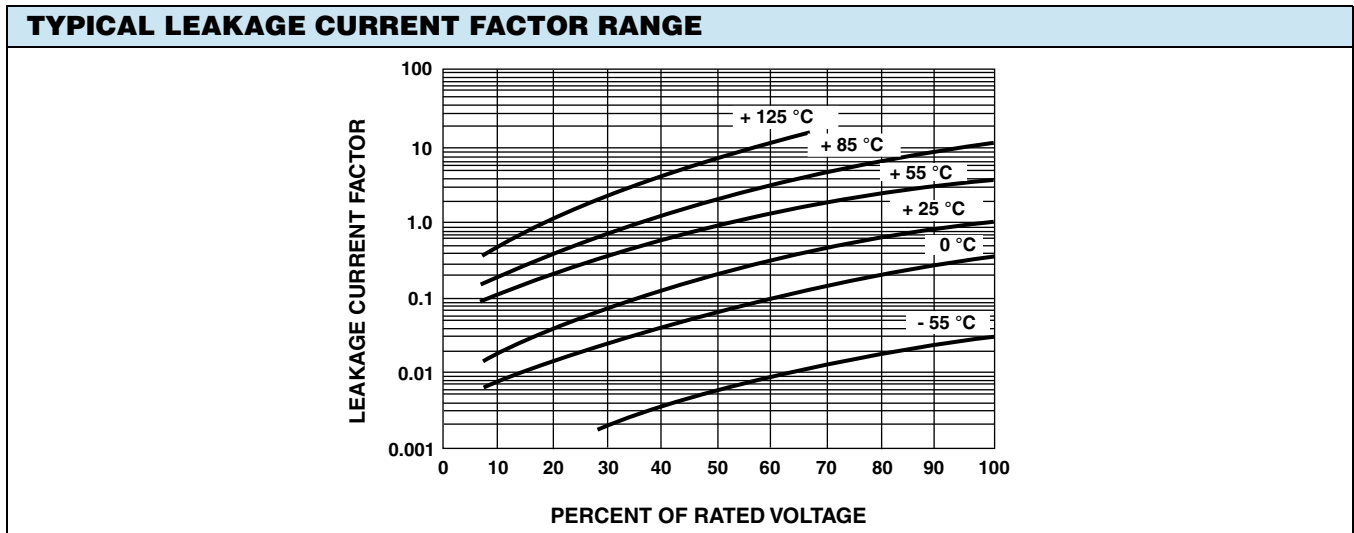

Notes

- At + 25 °C, the leakage current shall not exceed the value listed in the Standard Ratings Table
- At + 85 °C, the leakage current shall not exceed 10 times the value listed in the Standard Ratings Table
- At + 125 °C, the leakage current shall not exceed 12 times the value listed in the Standard Ratings Table

ENVIRONMENTAL PERFORMANCE CHARACTERISTICS			
ITEM	CONDITION	POST TEST PERFORMANCE	
Life Test at + 85 °C	1000 h application of rated voltage at 85 °C with a 3 Ω series resistance, MIL-STD-202G Method 108A	Capacitance change Dissipation factor Leakage current	Refer to Standard Ratings table Not to exceed 150 % of initial Not to exceed 200 % of initial
Humidity Tests	At 40 °C/90 % RH 500 h, no voltage applied. MIL-STD-202G Method 103B	Capacitance change Dissipation factor Leakage current	Refer to Standard Ratings table Not to exceed 150 % of initial Not to exceed 200 % of initial
Thermal Shock	At - 55 °C/+ 125 °C, 30 min each, for 5 cycles. MIL-STD-202G Method 107G	Capacitance change Dissipation factor Leakage current	Refer to Standard Ratings table Not to exceed 150 % of initial Not to exceed 200 % of initial

MECHANICAL PERFORMANCE CHARACTERISTICS			
TEST CONDITION	CONDITION	POST TEST PERFORMANCE	
Terminal Strength	Apply a pressure load of 5 N for 10 s ± 1 s horizontally to the center of capacitor side body. AEC Q-200 rev. C Method 006	Capacitance change Dissipation factor Leakage current	Refer to Standard Ratings table Initial specified value or less Initial specified value or less
		There shall be no mechanical or visual damage to capacitors	
Substrate Bending (Board flex)	With parts soldered onto substrate test board, apply force to the test board for a deflection of 1 mm. AEC-Q200 rev. C Method 005	Capacitance change Dissipation factor Leakage current	Refer to Standard Ratings table Initial specified value or less Initial specified value or less
Vibration	MIL-STD-202G, Method 204D, 10 Hz to 2000 Hz, 20 g peak	Capacitance change Dissipation factor Leakage current	Refer to Standard Ratings table Initial specified value or less Initial specified value or less
		There shall be no mechanical or visual damage to capacitors post-conditioning.	
Shock	MIL-STD-202G, Method 213B, Condition I, 100 g peak	Capacitance change Dissipation factor Leakage current	Refer to Standard Ratings table Initial specified value or less Initial specified value or less
		There shall be no mechanical or visual damage to capacitors post-conditioning.	
Resistance to Solder Heat	At 260 °C, for 10 s, reflow	Capacitance change Dissipation factor Leakage current	Refer to Standard Ratings table Not to exceed 150 % of initial Not to exceed 200 % of initial
		There shall be no mechanical or visual damage to capacitors post-conditioning.	
Solderability	MIL-STD-202G, Method 208H, ANSI/J-STD-002, Test B. Applies only to solder and tin plated terminations. Does not apply to gold terminations.	There shall be no mechanical or visual damage to capacitors post-conditioning.	
Resistance to Solvents	MIL-STD-202, Method 215D	There shall be no mechanical or visual damage to capacitors post-conditioning.	
Flammability	Encapsulation materials meet UL 94 V-0 with an oxygen index of 32 %.		

TYPICAL CURVES AT + 25 °C, IMPEDANCE AND ESR VS. FREQUENCY

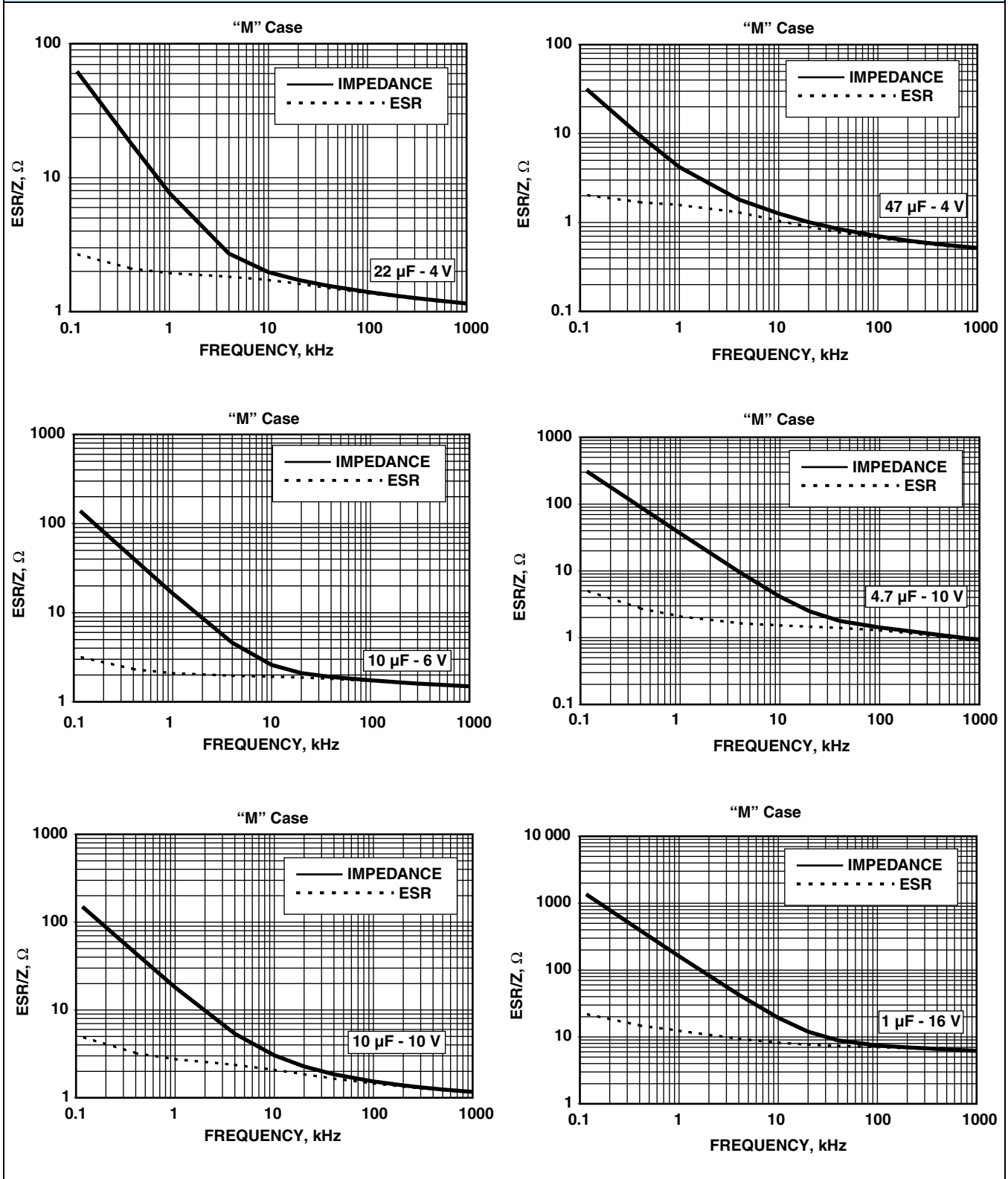

TYPICAL CURVES AT + 25 °C, IMPEDANCE AND ESR VS. FREQUENCY

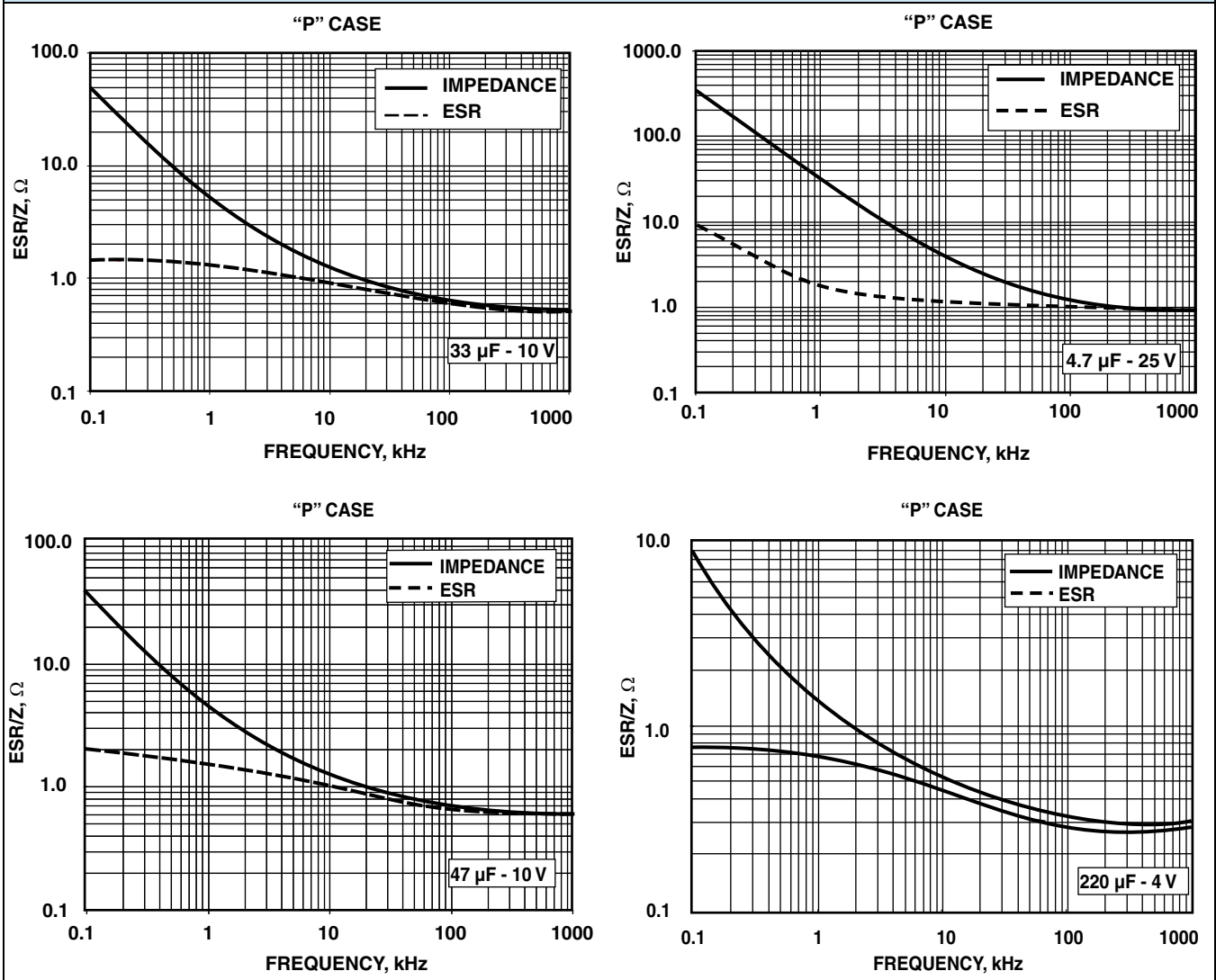

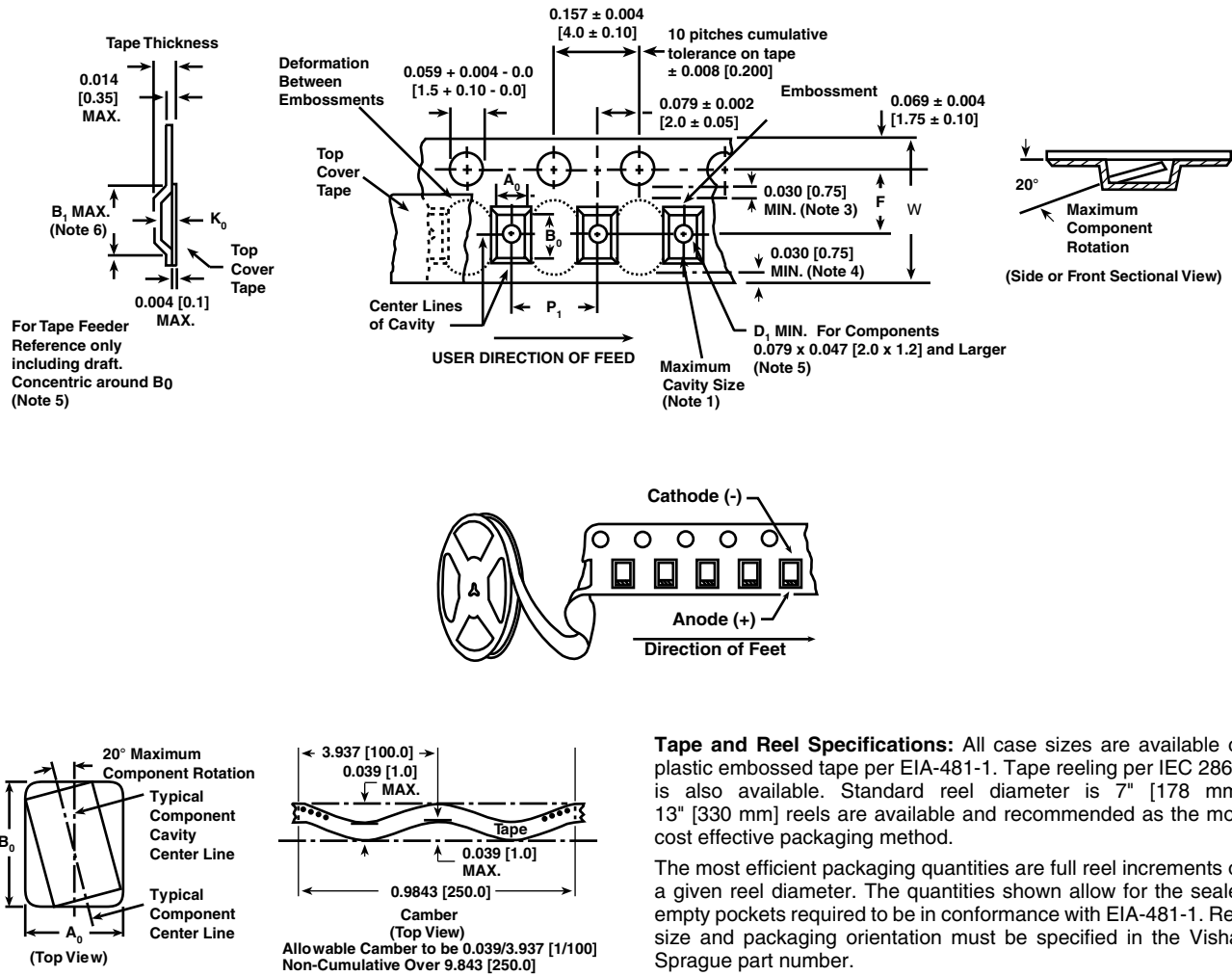
PLASTIC TAPE AND REEL PACKAGING in inches [millimeters]

Note

- Metric dimensions will govern. Dimensions in inches are rounded and for reference only.

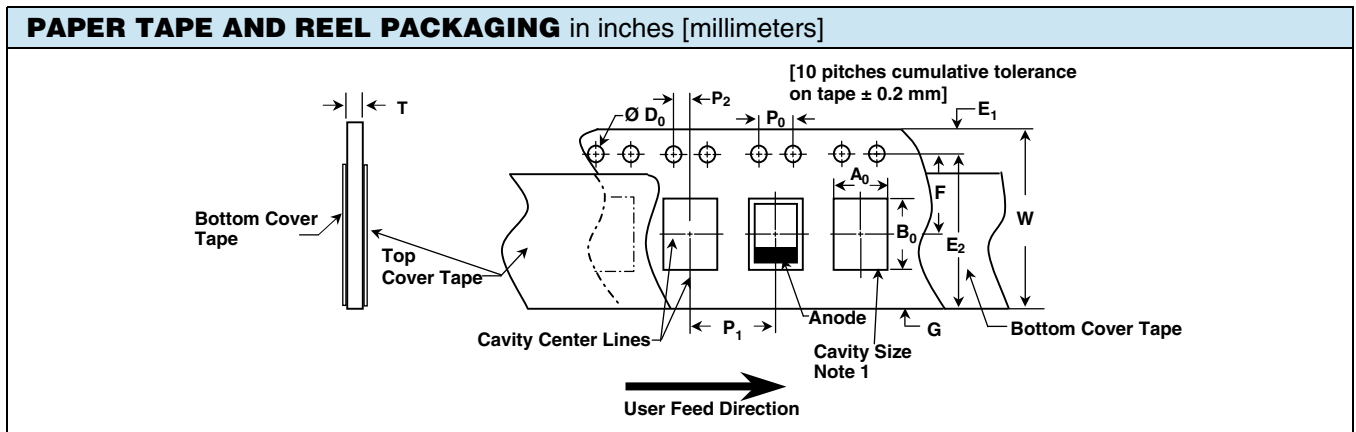
CASE CODE	TAPE SIZE	B ₁ (MAX.)	D ₁ (MIN.)	F	K ₀ (MAX.)	P ₁	W
298D							
P, R	8 mm	0.108 [2.75]	0.039 [1.0]	0.138 ± 0.002 [3.5 ± 0.05]	0.054 [1.37]	0.157 ± 0.004 [4.0 ± 1.0]	0.315 ± 0.0118/- 0.0039 [8.0 ± 0.30/- 0.10]



298D											
CASE SIZE	TAPE SIZE	A ₀	B ₀	D ₀	P ₀	P ₁	P ₂	E	F	W	T
K	8 mm	0.033 ± 0.002 [0.85 ± 0.05]	0.053 ± 0.002 [1.35 ± 0.05]	0.06 ± 0.004 [1.5 ± 0.1]	0.157 ± 0.004 [4.0 ± 0.1]	0.078 ± 0.004 [2.0 ± 0.1]	0.079 ± 0.002 [2.0 ± 0.05]	0.069 ± 0.004 [1.75 ± 0.1]	0.0138 ± 0.002 [3.5 ± 0.05]	0.315 ± 0.008 [8.0 ± 0.2]	0.03 ± 0.002 [0.75 ± 0.05]
M	8 mm	0.041 ± 0.002 [1.05 ± 0.05]	0.071 ± 0.002 [1.8 ± 0.05]	0.06 ± 0.004 [1.5 ± 0.1]	0.157 ± 0.004 [4.0 ± 0.1]	0.157 ± 0.004 [4.0 ± 0.1]	0.079 ± 0.002 [2.0 ± 0.05]	0.069 ± 0.004 [1.75 ± 0.1]	0.0138 ± 0.002 [3.5 ± 0.05]	0.315 ± 0.008 [8.0 ± 0.2]	0.037 ± 0.002 [0.95 ± 0.05]

STANDARD PACKAGING QUANTITY

SERIES	CASE CODE	QUANTITY (PCS/REEL)
		7" REEL
298D	K	5000
	M	4000
	P	3000
	R	2500

RECOMMENDED VOLTAGE DERATING GUIDELINES

STANDARD CONDITIONS: FOR EXAMPLE: OUTPUT FILTERS

Capacitor Voltage Rating	Operating Voltage
4.0	2.5
6.3	3.6
10	6.0
16	10
20	12
25	15
35	24
50	28

SEVERE CONDITIONS: FOR EXAMPLE: INPUT FILTERS

Capacitor Voltage Rating	Operating Voltage
4.0	2.5
6.3	3.3
10	5.0
16	8.0
20	10
25	12
35	15
50	24

POWER DISSIPATION		
CASE CODE		MAXIMUM PERMISSIBLE POWER DISSIPATION AT + 25 °C (W) IN FREE AIR
298D	K	0.015
	M	0.025
	P	0.045
	R	0.045

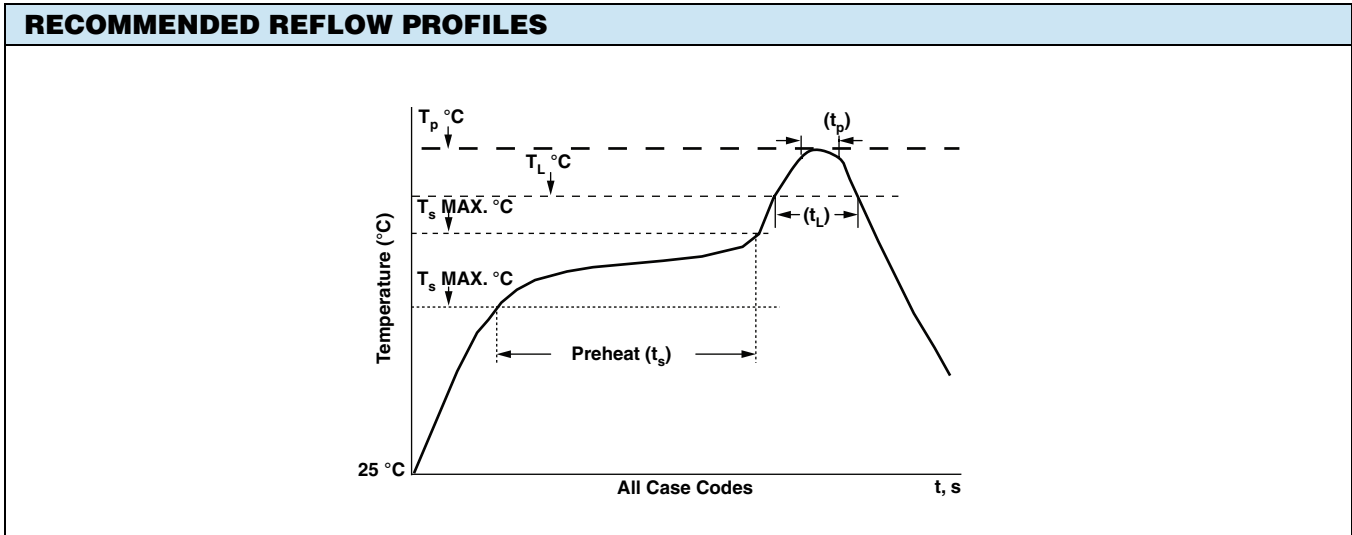

TYPE	T _p Lead (Pb)-free	T _p Sn/Pb	t _p	T _L Lead (Pb)-free	T _L Sn/Pb	T _s MIN. Lead (Pb)-free	T _s MIN. Sn/Pb	T _s MAX. Lead (Pb)-free	T _s MAX. Sn/Pb	t _s Lead (Pb)-free	t _s Sn/Pb	t _L
298D	260 °C	225 °C	10	217 °C	183 °C	150 °C	100 °C	200 °C	150 °C	60 to 150	60 to 90	60

PAD DIMENSIONS in inches [millimeters]

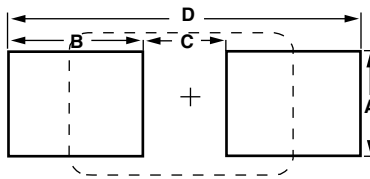

CASE CODE	A (MIN.)	B (NOM.)	C (NOM.)	D (NOM.)
298D				
K	0.028 [0.70]	0.018 [0.45]	0.024 [0.60]	0.059 [1.50]
M	0.039 [1.00]	0.028 [0.70]	0.24 [0.60]	0.080 [2.00]
P	0.063 [1.60]	0.031 [0.80]	0.047 [1.20]	0.110 [2.80]
R	0.059 [1.50]	0.031 [0.80]	0.039 [1.0]	0.102 [2.60]

GUIDE TO APPLICATION

1. **A-C Ripple Current:** The maximum allowable ripple current shall be determined from the formula:

$$I_{\text{rms}} = \sqrt{\frac{P}{R_{\text{ESR}}}}$$

where,

P = Power dissipation in Watts at + 25 °C as given in the table in paragraph number 5 (power dissipation).

R_{ESR} = The capacitor equivalent series resistance at the specified frequency.

2. **A-C Ripple Voltage:** The maximum allowable ripple voltage shall be determined from the formula:

$$V_{\text{rms}} = Z \sqrt{\frac{P}{R_{\text{ESR}}}}$$

or, from the formula:

$$V_{\text{rms}} = I_{\text{rms}} \times Z$$

where,

P = Power dissipation in Watts at + 25 °C as given in the table in paragraph number 5 (power dissipation).

R_{ESR} = The capacitor equivalent series resistance at the specified frequency.

Z = The capacitor impedance at the specified frequency.

- 2.1 The sum of the peak AC voltage plus the applied DC voltage shall not exceed the DC voltage rating of the capacitor.
- 2.2 The sum of the negative peak AC voltage plus the applied DC voltage shall not allow a voltage reversal exceeding 10 % of the DC working voltage at + 25 °C.
3. **Reverse Voltage:** These capacitors are capable of withstanding peak voltages in the reverse direction equal to 10 % of the DC rating at + 25 °C, 5 % of the DC rating at + 85 °C and 1 % of the DC rating at + 125 °C.
4. **Temperature Derating:** If these capacitors are to be operated at temperatures above + 25 °C, the permissible rms ripple current or voltage shall be calculated using the derating factors as shown:

TEMPERATURE	DERATING FACTOR
+ 25 °C	1.0
+ 85 °C	0.9
+ 125 °C	0.4

5. **Power Dissipation:** Power dissipation will be affected by the heat sinking capability of the mounting surface. Non-sinusoidal ripple current may produce heating effects which differ from those shown. It is important that the equivalent I_{rms} value be established when calculating permissible operating levels. (Power Dissipation calculated using + 25 °C temperature rise.)

6. **Printed Circuit Board Materials:** Molded capacitors are compatible with commonly used printed circuit board materials (alumina substrates, FR4, FR5, G10, PTFE-fluorocarbon and porcelainized steel).

7. **Attachment:**

- 7.1 **Solder Paste:** The recommended thickness of the solder paste after application is 0.007" ± 0.001" [0.178 mm ± 0.025 mm]. Care should be exercised in selecting the solder paste. The metal purity should be as high as practical. The flux (in the paste) must be active enough to remove the oxides formed on the metallization prior to the exposure to soldering heat. In practice this can be aided by extending the solder preheat time at temperatures below the liquidous state of the solder.

- 7.2 **Soldering:** Capacitors can be attached by conventional soldering techniques; vapor phase, convection reflow, infrared reflow, wave soldering and hot plate methods. The Soldering Profile charts show recommended time/temperature conditions for soldering. Preheating is recommended. The recommended maximum ramp rate is 2 °C per second. Attachment with a soldering iron is not recommended due to the difficulty of controlling temperature and time at temperature. The soldering iron must never come in contact with the capacitor.

- 7.2.1 **Backward and Forward Compatibility:** Capacitors with SnPb or 100 % tin termination finishes can be soldered using SnPb or lead (Pb)-free soldering processes.

8. **Cleaning (Flux Removal) After Soldering:** Molded capacitors are compatible with all commonly used solvents such as TES, TMS, Prelete, Chloroethane, Terpene and aqueous cleaning media. However, CFC/ODS products are not used in the production of these devices and are not recommended. Solvents containing methylene chloride or other epoxy solvents should be avoided since these will attack the epoxy encapsulation material.

- 8.1 When using ultrasonic cleaning, the board may resonate if the output power is too high. This vibration can cause cracking or a decrease in the adherence of the termination. DO NOT EXCEED 9W/l at 40 kHz for 2 minutes.

9. **Recommended Mounting Pad Geometries:** Proper mounting pad geometries are essential for successful solder connections. These dimensions are highly process sensitive and should be designed to minimize component rework due to unacceptable solder joints. The dimensional configurations shown are the recommended pad geometries for both wave and reflow soldering techniques. These dimensions are intended to be a starting point for circuit board designers and may be fine tuned if necessary based upon the peculiarities of the soldering process and/or circuit board design.



Disclaimer

All product specifications and data are subject to change without notice.

Vishay Intertechnology, Inc., its affiliates, agents, and employees, and all persons acting on its or their behalf (collectively, "Vishay"), disclaim any and all liability for any errors, inaccuracies or incompleteness contained herein or in any other disclosure relating to any product.

Vishay disclaims any and all liability arising out of the use or application of any product described herein or of any information provided herein to the maximum extent permitted by law. The product specifications do not expand or otherwise modify Vishay's terms and conditions of purchase, including but not limited to the warranty expressed therein, which apply to these products.

No license, express or implied, by estoppel or otherwise, to any intellectual property rights is granted by this document or by any conduct of Vishay.

The products shown herein are not designed for use in medical, life-saving, or life-sustaining applications unless otherwise expressly indicated. Customers using or selling Vishay products not expressly indicated for use in such applications do so entirely at their own risk and agree to fully indemnify Vishay for any damages arising or resulting from such use or sale. Please contact authorized Vishay personnel to obtain written terms and conditions regarding products designed for such applications.

Product names and markings noted herein may be trademarks of their respective owners.