

## Peak Emission Wavelength: 325nm

The MTC325SS-UV UV chip on large silicon submount is specifically designed for applications requiring high radiant power output and custom packaging solutions.

### FEATURES

- > High-Power UV LED Chip
- > High Reliability
- > Chip Size: 870um x 770um

### APPLICATIONS

- > Analytical Instruments for Bio Chemical, Medical and Scientific Analysis
- > Photo Catalyst / UV Curing
- > Medical Phototherapy

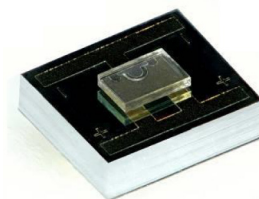

## Absolute Maximum Ratings (Ta=25°C)



ITEMS	SYMBOL	RATINGS	UNIT
Forward Current	IF	40	mA
Reverse Voltage	VR	5	V
Operating Temperature	Topr	-30 ~ +80	°C
Storage Temperature	Tstg	-40 ~ +100	°C
Soldering Temperature*1	Tsol	300	°C

\*1: Within 5 seconds.

## Electrical & Optical Characteristics (Ta = 25°C)\*1

ITEMS	SYMBOL	CONDITIONS	MIN.	TYP	MAX.	UNIT
Peak Wavelength	$\lambda_p$	IF=20mA	320	325	330	nm
Power Output	PO	IF=20mA	1.0	1.5	--	mW
Spectral Line Half Width	$\Delta\lambda$	IF=20mA	--	9	--	nm
Forward Voltage	VF	IF=20mA	--	5.0	5.5	V
Viewing Angle	$2\Theta_{1/2}$	IF=20mA	--	144	--	deg
Reverse Current	IR	VR=5V	--	--	1	$\mu$ A

\*1: All measurements were made using a Au-plated TO5 header without an encapsulant.

200005000

Top View

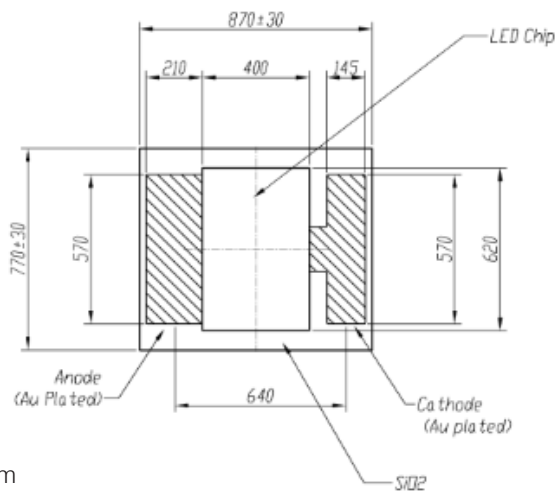

Unit:  $\mu\text{m}$

Side View

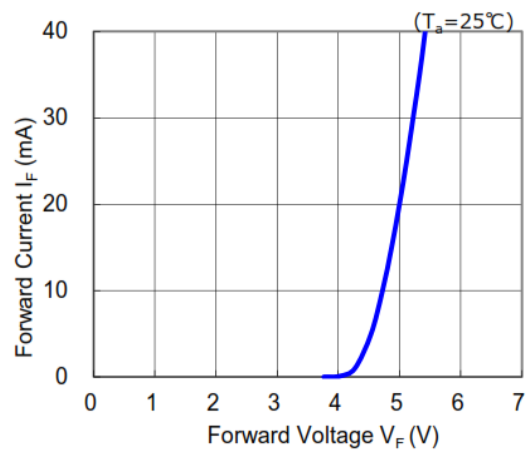
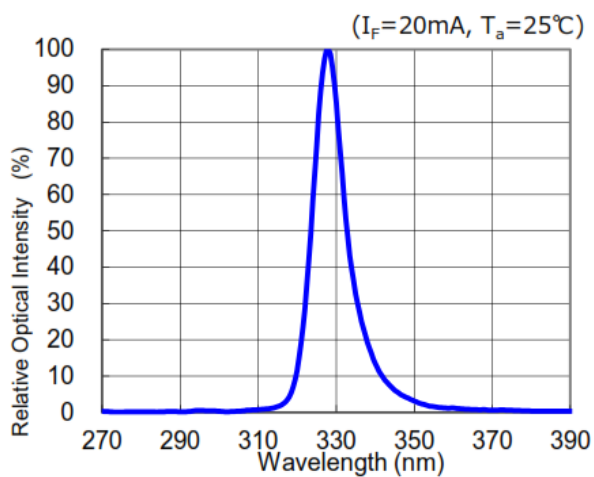
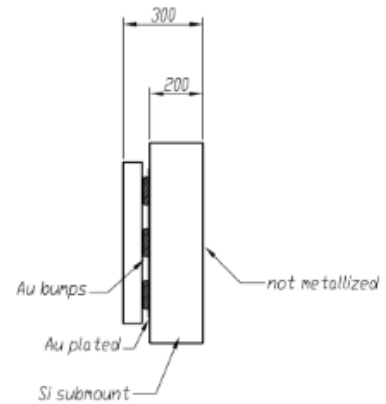

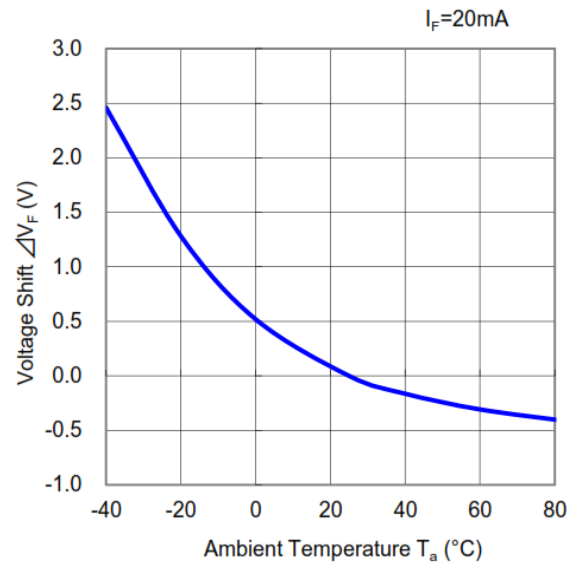
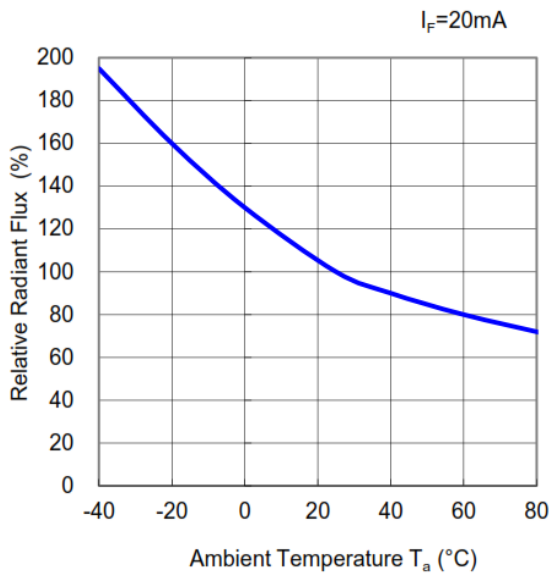
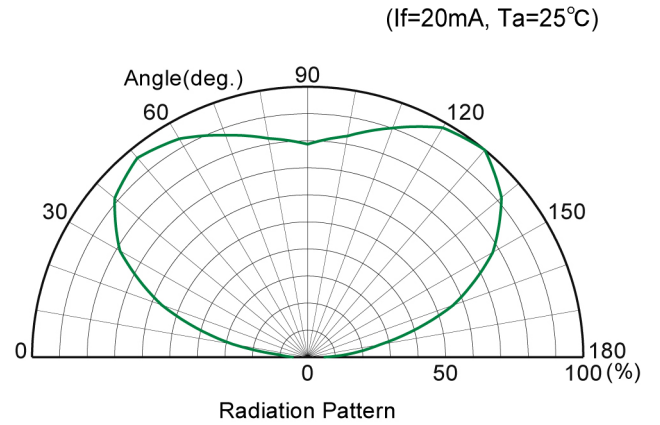
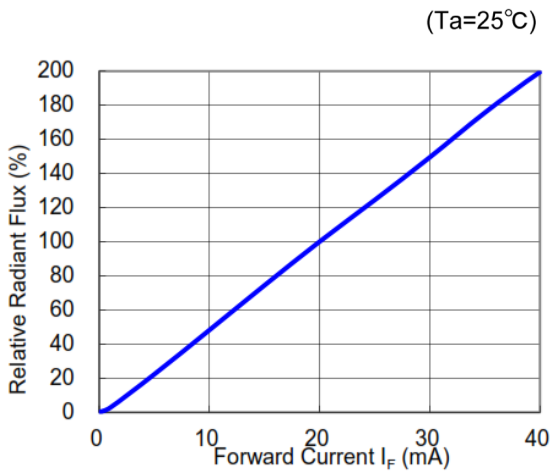

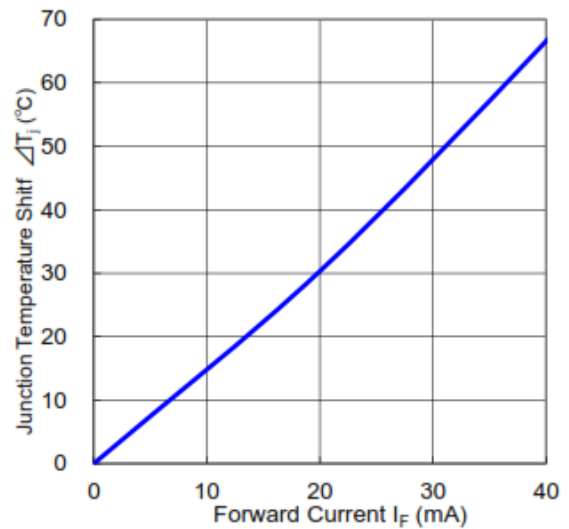
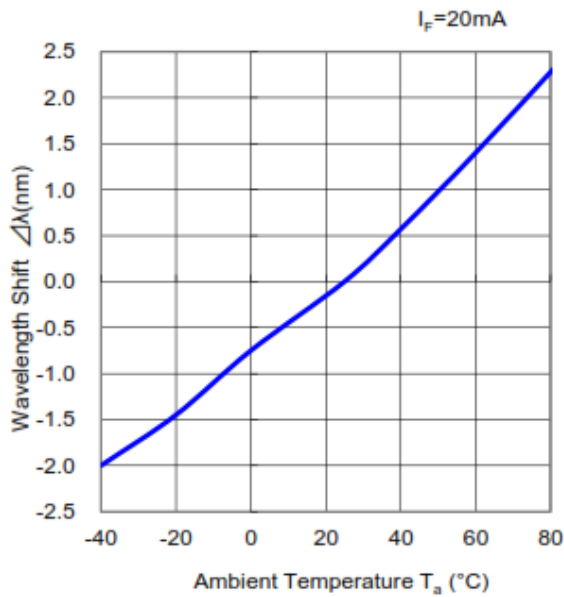

**CAUTION**

1. LEDs emit very strong UV radiation during operation.
2. Don't look directly into the LED light when in operation as UV radiation can harm your eyes.
3. To prevent even inadequate exposure, wear protective eyewear.
4. If LEDs are embedded in devices, please indicate warning labels against the UV LED used.
5. Avoid prolonged exposure to skin or other tissue during operation.
6. Keep out of reach of children.
7. Take appropriate precautions around pets and other living organisms to avoid UV exposure.
8. Specification and dimension are subject to change without notice.