

2801 THRU 2825

T-43-25

HIGH-VOLTAGE, HIGH-CURRENT DARLINGTON ARRAYS

ULS28XXH/R

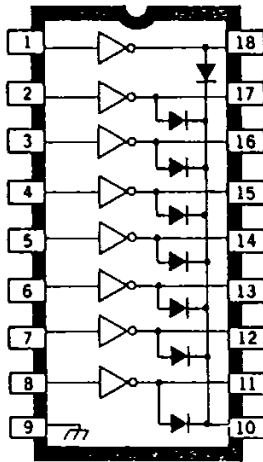

Dwg. No. A-10,322

ABSOLUTE MAXIMUM RATINGS

Output Voltage, V_{CE}	
(ULS280X*, ULS281X*)	50 V
(ULS282X*)	95 V
Input Voltage, V_{IN}	
(ULS28X2*, X3*, X4*)	30 V
(ULS28X5*)	15 V
Peak Output Current, I_{OUT}	
(ULS280X*, ULS282X*)	500 mA
(ULS281X*)	600 mA
Ground Terminal Current, I_{GND}	3.0 A
Continuous Input Current, I_{IN}	25 mA
Power Dissipation, P_D	
(one Darlington pair)	1.0 W
(total package)	See Graph
Operating Temperature Range, T_A	-55°C to +125°C
Storage Temperature Range, T_S	-65°C to +150°C

X = digit to identify specific device. Characteristic shown applies to family of devices with remaining digits as shown.

*Complete part number includes a final letter to indicate package.

Designed to serve as interface between low-level circuitry and high-power loads, Series ULS2800EK, ULS2800H, and ULS2800R arrays consist of eight silicon NPN Darlington power drivers on a common monolithic substrate. They are ideally suited to driving relays, solenoids, magnetic print hammers, lamps, and other devices in high-reliability military or aerospace applications with up to 3 A output current per package.

These devices are screened to MIL-STD-883, Class B and are supplied in a leadless ceramic chip carrier with Kovar lid (suffix 'EK'), the popular ceramic/metal side-brazed 18-pin hermetic package (suffix 'H'), or ceramic/glass cer-DIP hermetic package (suffix 'R'). All package styles conform to the dimensional requirements of MIL-M-38510 and are rated for operation over the full military temperature range of -55°C to +125°C. Reverse-bias burn-in and 100% high-reliability screening are standard.

The 35 integrated circuits described here permit the circuit designer to select the optimal device for any application. In addition to the three package styles (note that the ceramic chip carrier is available only for the ULS2801EK through ULS2805EK devices), there are five input characteristics, two output-voltage ratings, and two output-current ratings. The appropriate part for specific applications can be determined from the Device Part Number Designation chart. All units have open-collector outputs and on-chip diodes for inductive-load transient suppression.

FEATURES

- TTL, DTL, PMOS, or CMOS Compatible Inputs
- Peak Output Current to 600 mA
- Transient-Protected Outputs
- High-Reliability Screening to MIL-STD-883, Class B
- -55°C to +125°C Temperature Range

ULS280XEK

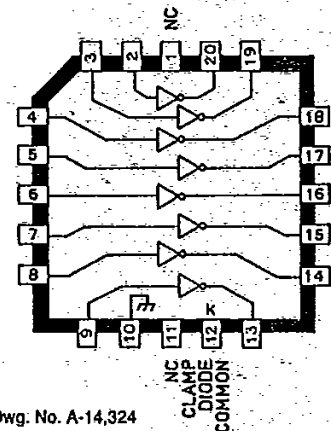

Dwg. No. A-14,324

Always order by complete part number, e.g., **ULS2813H883**. See matrix on next page.

2801 THRU 2825 HIGH VOLTAGE, HIGH-CURRENT DARLINGTON ARRAYS

7-43-75

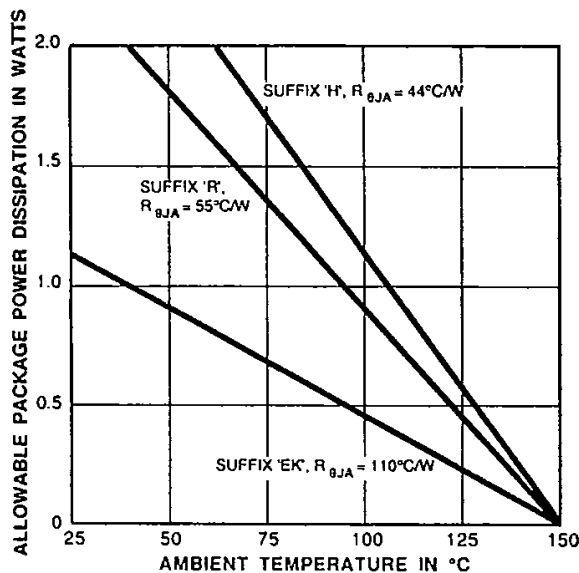

Dwg. GM-005

DEVICE PART NUMBER DESIGNATION

$V_{CE(MAX)}$	50 V	50 V	95 V
$I_{C(MAX)}$	500 mA	600 mA	500 mA
Logic	Part Number		
General Purpose PMOS, CMOS	ULS2801*	ULS2811*	ULS2821*
14-25 V PMOS	ULS2802*	ULS2812*	ULS2822*
5 V TTL, CMOS	ULS2803*	ULS2813*	ULS2823*
6-15 V CMOS, PMOS	ULS2804*	ULS2814*	ULS2824*
High-Output TTL	ULS2805*	ULS2815*	ULS2825*

PARTIAL SCHEMATICS

**ULS28X1°
(Each Driver)**

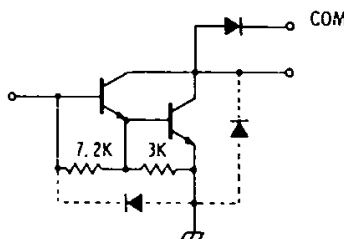

Dwg. No A-9595

**ULS28X2°
(Each Driver)**

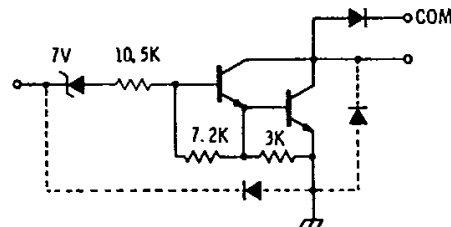

Dwg. No A-9650

**ULS28X3°
(Each Driver)**

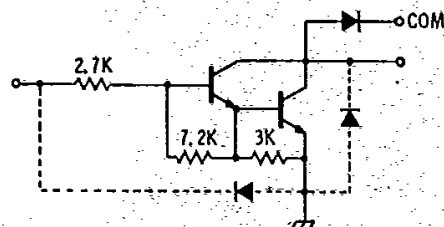

Dwg. No. A-9651

**ULS28X4°
(Each Driver)**

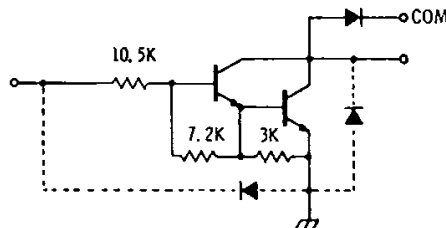

Dwg. No. A-9898A

**ULS28X5°
(Each Driver)**

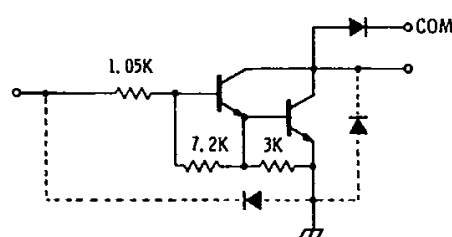

Dwg. No. A-10,228

* Complete part number includes a final letter to indicate package (EK = leadless ceramic chip carrier, H = ceramic/metal side-brazed, R = ceramic/glass cer-DIP).

X = digit to identify specific device. Specification or limit shown applies to family of devices with remaining digits as shown.

ULS2801EK/H/R THRU ULS2805EK/H/R

ELECTRICAL CHARACTERISTICS over operating temperature range (unless otherwise noted)

Characteristic	Symbol	Applicable Devices	Test Conditions			Limits			
			Temp.	Voltage/Current	Fig.	Min.	Typ.	Max.	Units
Output Leakage Current	I_{CEX}	All		$V_{CE} = 50\text{ V}$	1A	—	—	100	μA
		ULS2802*		$V_{CE} = 50\text{ V}, V_{IN} = 6\text{ V}$	1B	—	—	500	μA
		ULS2804*		$V_{CE} = 50\text{ V}, V_{IN} = 1\text{ V}$	1B	—	—	500	μA
Collector-Emitter Saturation Voltage	$V_{CE(SAT)}$	All	-55°C	$I_C = 350\text{ mA}, I_B = 850\text{ }\mu\text{A}$	2	—	1.6	1.8	V
				$I_C = 200\text{ mA}, I_B = 550\text{ }\mu\text{A}$	2	—	1.3	1.5	V
				$I_C = 100\text{ mA}, I_B = 350\text{ }\mu\text{A}$	2	—	1.1	1.3	V
			+25°C	$I_C = 350\text{ mA}, I_B = 500\text{ }\mu\text{A}$	2	—	1.25	1.6	V
				$I_C = 200\text{ mA}, I_B = 350\text{ }\mu\text{A}$	2	—	1.1	1.3	V
				$I_C = 100\text{ mA}, I_B = 250\text{ }\mu\text{A}$	2	—	0.9	1.1	V
			+125°C	$I_C = 350\text{ mA}^\dagger, I_B = 500\text{ }\mu\text{A}$	2	—	1.6	1.8	V
				$I_C = 200\text{ mA}^\dagger, I_B = 350\text{ }\mu\text{A}$	2	—	1.3	1.5	V
				$I_C = 100\text{ mA}, I_B = 250\text{ }\mu\text{A}$	2	—	1.1	1.3	V
Input Current	$I_{IN(ON)}$	ULS2802*		$V_{IN} = 17\text{ V}$	3	480	850	1300	μA
		ULS2803*		$V_{IN} = 3.85\text{ V}$	3	650	930	1350	μA
		ULS2804*		$V_{IN} = 5.0\text{ V}$	3	240	350	500	μA
				$V_{IN} = 12\text{ V}$	3	650	1000	1450	μA
		ULS2805*		$V_{IN} = 3.0\text{ V}$	3	—	1500	2400	μA
	$I_{IN(OFF)}$	All	+125°C	$I_C = 500\text{ }\mu\text{A}$	4	25	50	—	μA
Input Voltage	$V_{IN(ON)}$	ULS2802*	-55°C	$V_{CE} = 2.0\text{ V}, I_C = 300\text{ mA}$	5	—	—	18	V
			+125°C	$V_{CE} = 2.0\text{ V}, I_C = 300\text{ mA}^\dagger$	5	—	—	13	V
		ULS2803*	-55°C	$V_{CE} = 2.0\text{ V}, I_C = 200\text{ mA}$	5	—	—	3.3	V
				$V_{CE} = 2.0\text{ V}, I_C = 250\text{ mA}$	5	—	—	3.6	V
				$V_{CE} = 2.0\text{ V}, I_C = 300\text{ mA}$	5	—	—	3.9	V
				$V_{CE} = 2.0\text{ V}, I_C = 300\text{ mA}$	5	—	—	3.9	V
		+125°C	$V_{CE} = 2.0\text{ V}, I_C = 200\text{ mA}^\dagger$	5	—	—	2.4	V	
			$V_{CE} = 2.0\text{ V}, I_C = 250\text{ mA}^\dagger$	5	—	—	2.7	V	
$V_{CE} = 2.0\text{ V}, I_C = 300\text{ mA}^\dagger$	5		—	—	3.0	V			

*Complete part number includes a final letter to indicate package (EK = leadless ceramic chip carrier, H = ceramic/metal side-brazed, R = ceramic/glass cer-DIP).

Continued next page...

NOTE 1: All limits stated apply to the complete Darlington series except as specified for a single device type.

NOTE 2: The $I_{IN(OFF)}$ current limit guarantees against partial turn-on of the output.

NOTE 3: The $V_{IN(ON)}$ voltage limit guarantees a minimum output sink current per the specified test conditions.

[†]Pulse Test, $t_p \leq 1\text{ }\mu\text{s}$, see graph.

ULS2801EK/H/R THRU ULS2805EK/H/R ELECTRICAL CHARACTERISTICS continued

Characteristic	Symbol	Applicable Devices	Test Conditions			Limits			
			Temp.	Voltage/Current	Fig.	Min.	Typ.	Max.	Units
Input Voltage (cont.)	$V_{IN(OH)}$	ULS2804*	-55°C	$V_{CE} = 2.0 \text{ V}, I_C = 125 \text{ mA}$	5	—	—	6.0	V
				$V_{CE} = 2.0 \text{ V}, I_C = 200 \text{ mA}$	5	—	—	8.0	V
				$V_{CE} = 2.0 \text{ V}, I_C = 275 \text{ mA}$	5	—	—	10	V
				$V_{CE} = 2.0 \text{ V}, I_C = 350 \text{ mA}$	5	—	—	12	V
			+125°C	$V_{CE} = 2.0 \text{ V}, I_C = 125 \text{ mA}$	5	—	—	5.0	V
				$V_{CE} = 2.0 \text{ V}, I_C = 200 \text{ mA}^\dagger$	5	—	—	6.0	V
				$V_{CE} = 2.0 \text{ V}, I_C = 275 \text{ mA}^\dagger$	5	—	—	7.0	V
				$V_{CE} = 2.0 \text{ V}, I_C = 350 \text{ mA}^\dagger$	5	—	—	8.0	V
ULS2805*	-55°C	$V_{CE} = 2.0 \text{ V}, I_C = 350 \text{ mA}$	5	—	—	3.0	V		
	+125°C	$V_{CE} = 2.0 \text{ V}, I_C = 350 \text{ mA}^\dagger$	5	—	—	2.4	V		
D-C Forward Current Transfer Ratio	h_{FE}	ULS2801*	-55°C	$V_{CE} = 2.0 \text{ V}, I_C = 350 \text{ mA}$	2	500	—	—	—
			+25°C	$V_{CE} = 2.0 \text{ V}, I_C = 350 \text{ mA}$	2	1000	—	—	—
Turn-On Delay	t_{PLH}	All	+25°C		8	—	250	1000	ns
Turn-Off Delay	t_{PHL}	All	+25°C		8	—	250	1000	ns
Clamp Diode Leakage Current	I_R	All		$V_R = 50 \text{ V}$	6	—	—	50	μA
Clamp Diode Forward Voltage	V_F	All		$I_F = 350 \text{ mA}^\dagger$	7	—	1.7	2.0	V

*Complete part number includes a final letter to indicate package (EK = leadless ceramic chip carrier, H = ceramic/metal side-brazed, R = ceramic/glass cer-DIP).

NOTE 1: All limits stated apply to the complete Darlington series except as specified for a single device type.

NOTE 2: The $I_{IN(OFF)}$ current limit guarantees against partial turn-on of the output.

NOTE 3: The $V_{IN(OH)}$ voltage limit guarantees a minimum output sink current per the specified test conditions.

† Pulse Test, $t_p \leq 1 \mu\text{s}$, see graph.

2801 THRU 2825 HIGH VOLTAGE, HIGH-CURRENT DARLINGTON ARRAYS

T-43-25

ULS2811H/R THRU ULS2815H/R ELECTRICAL CHARACTERISTICS over operating temperature range (unless otherwise noted)

Characteristic	Symbol	Applicable Devices	Test Conditions			Limits			
			Temp.	Voltage/Current	Fig.	Min.	Typ.	Max.	Units
Output Leakage Current	I_{CEX}	All		$V_{CE} = 50\text{ V}$	1A	—	—	100	μA
		ULS2812*		$V_{CE} = 50\text{ V}, V_{IN} = 6\text{ V}$	1B	—	—	500	μA
		ULS2814*		$V_{CE} = 50\text{ V}, V_{IN} = 1\text{ V}$	1B	—	—	500	μA
Collector-Emitter Saturation Voltage	$V_{CE(SAT)}$	All	-55°C	$I_C = 500\text{ mA}, I_B = 1100\text{ }\mu\text{A}$	2	—	1.8	2.1	V
				$I_C = 350\text{ mA}, I_B = 850\text{ }\mu\text{A}$	2	—	1.6	1.8	V
				$I_C = 200\text{ mA}, I_B = 550\text{ }\mu\text{A}$	2	—	1.3	1.5	V
			+25°C	$I_C = 500\text{ mA}, I_B = 600\text{ }\mu\text{A}$	2	—	1.7	1.9	V
				$I_C = 350\text{ mA}, I_B = 500\text{ }\mu\text{A}$	2	—	1.25	1.6	V
				$I_C = 200\text{ mA}, I_B = 350\text{ }\mu\text{A}$	2	—	1.1	1.3	V
			+125°C	$I_C = 500\text{ mA}^\dagger, I_B = 600\text{ }\mu\text{A}$	2	—	1.8	2.1	V
				$I_C = 350\text{ mA}^\dagger, I_B = 500\text{ }\mu\text{A}$	2	—	1.6	1.8	V
				$I_C = 200\text{ mA}^\dagger, I_B = 350\text{ }\mu\text{A}$	2	—	1.3	1.5	V
Input Current	$I_{IN(ON)}$	ULS2812*		$V_{IN} = 17\text{ V}$	3	480	850	1300	μA
		ULS2813*		$V_{IN} = 3.85\text{ V}$	3	650	930	1350	μA
		ULS2814*		$V_{IN} = 5.0\text{ V}$	3	240	350	500	μA
				$V_{IN} = 12\text{ V}$	3	650	1000	1450	μA
		ULS2815*		$V_{IN} = 3.0\text{ V}$	3	—	1500	2400	μA
	$I_{IN(OFF)}$	All	+125°C	$I_C = 500\text{ }\mu\text{A}$	4	25	50	—	μA
Input Voltage	$V_{IN(ON)}$	ULS2812*	-55°C	$V_{CE} = 2.0\text{ V}, I_C = 500\text{ mA}$	5	—	—	23.5	V
			+125°C	$V_{CE} = 2.0\text{ V}, I_C = 500\text{ mA}^\dagger$	5	—	—	17	V
		ULS2813*	-55°C	$V_{CE} = 2.0\text{ V}, I_C = 250\text{ mA}$	5	—	—	3.6	V
				$V_{CE} = 2.0\text{ V}, I_C = 300\text{ mA}$	5	—	—	3.9	V
			+125°C	$V_{CE} = 2.0\text{ V}, I_C = 500\text{ mA}$	5	—	—	6.0	V
				$V_{CE} = 2.0\text{ V}, I_C = 250\text{ mA}^\dagger$	5	—	—	2.7	V
			$V_{CE} = 2.0\text{ V}, I_C = 300\text{ mA}^\dagger$	5	—	—	3.0	V	
			$V_{CE} = 2.0\text{ V}, I_C = 500\text{ mA}^\dagger$	5	—	—	3.5	V	

*Complete part number includes a final letter to indicate package (H = ceramic/metal side-brazed, R = ceramic/glass cer-DIP).

Continued next page...

NOTE 1: All limits stated apply to the complete Darlington series except as specified for a single device type.

NOTE 2: The $I_{IN(OFF)}$ current limit guarantees against partial turn-on of the output.

NOTE 3: The $V_{IN(ON)}$ voltage limit guarantees a minimum output sink current per the specified test conditions.

†Pulse Test, $t_p \leq 1\text{ }\mu\text{s}$, see graph.

2801 THRU 2825 HIGH VOLTAGE, HIGH CURRENT DARLINGTON ARRAYS

T-43-25

ULS2811H/R THRU ULS2815H/R ELECTRICAL CHARACTERISTICS continued

Characteristic	Symbol	Applicable Devices	Test Conditions			Limits			
			Temp.	Voltage/Current	Fig.	Min.	Typ.	Max.	Units
Input Voltage (cont.)	$V_{IN(ON)}$	ULS2814*	-55°C	$V_{CE} = 2.0\text{ V}, I_C = 275\text{ mA}$	5	—	—	10	V
				$V_{CE} = 2.0\text{ V}, I_C = 350\text{ mA}$	5	—	—	12	V
				$V_{CE} = 2.0\text{ V}, I_C = 500\text{ mA}$	5	—	—	17	V
			+125°C	$V_{CE} = 2.0\text{ V}, I_C = 275\text{ mA}^\dagger$	5	—	—	7.0	V
				$V_{CE} = 2.0\text{ V}, I_C = 350\text{ mA}^\dagger$	5	—	—	8.0	V
				$V_{CE} = 2.0\text{ V}, I_C = 500\text{ mA}^\dagger$	5	—	—	9.5	V
		ULS2815*	-55°C	$V_{CE} = 2.0\text{ V}, I_C = 350\text{ mA}$	5	—	—	3.0	V
				$V_{CE} = 2.0\text{ V}, I_C = 500\text{ mA}$	5	—	—	3.5	V
+125°C	$V_{CE} = 2.0\text{ V}, I_C = 350\text{ mA}^\dagger$		5	—	—	2.4	V		
	$V_{CE} = 2.0\text{ V}, I_C = 500\text{ mA}^\dagger$		5	—	—	2.6	V		
D-C Forward Current Transfer Ratio	h_{FE}	ULS2811*	-55°C	$V_{CE} = 2.0\text{ V}, I_C = 500\text{ mA}$	2	450	—	—	—
			+25°C	$V_{CE} = 2.0\text{ V}, I_C = 500\text{ mA}$	2	900	—	—	—
Turn-On Delay	t_{PLH}	All	+25°C		8	—	250	1000	ns
Turn-Off Delay	t_{PHL}	All	+25°C		8	—	250	1000	ns
Clamp Diode Leakage Current	I_R	All		$V_R = 50\text{ V}$	6	—	—	50	μA
Clamp Diode Forward Voltage	V_F	All		$I_F = 350\text{ mA}^\dagger$	7	—	1.7	2.0	V
				$I_F = 500\text{ mA}^\dagger$	7	—	—	2.5	V

*Complete part number includes a final letter to indicate package (H = ceramic/metal side-brazed, R = ceramic/glass cer-DIP).

NOTE 1: All limits stated apply to the complete Darlington series except as specified for a single device type.

NOTE 2: The $I_{IN(OFF)}$ current limit guarantees against partial turn-on of the output.

NOTE 3: The $V_{IN(ON)}$ voltage limit guarantees a minimum output sink current per the specified test conditions.

† Pulse Test, $t_p \leq 1\ \mu\text{s}$, see graph.

2801 THRU 2825 HIGH VOLTAGE, HIGH CURRENT DARLINGTON ARRAYS

T-43-25

ULS2821H/R THRU ULS2825H/R ELECTRICAL CHARACTERISTICS over operating temperature range (unless otherwise noted)

Characteristic	Symbol	Applicable Devices	Test Conditions			Limits			Units
			Temp.	Voltage/Current	Fig.	Min.	Typ.	Max.	
Output Leakage Current	I_{CEX}	All		$V_{CE} = 95\text{ V}$	1A	—	—	100	μA
		ULS2822*		$V_{CE} = 95\text{ V}, V_{IN} = 6\text{ V}$	1B	—	—	500	μA
		ULS2824*	+25°C	$V_{CE} = 95\text{ V}, V_{IN} = 1\text{ V}$	1B	—	—	500	μA
			+125°C	$V_{CE} = 95\text{ V}, V_{IN} = 0.5\text{ V}$	1B	—	—	500	μA
Collector-Emitter Saturation Voltage	$V_{CE(SAT)}$	All	-55°C	$I_C = 350\text{ mA}, I_B = 850\text{ }\mu\text{A}$	2	—	1.6	1.8	V
				$I_C = 200\text{ mA}, I_B = 550\text{ }\mu\text{A}$	2	—	1.3	1.5	V
				$I_C = 100\text{ mA}, I_B = 350\text{ }\mu\text{A}$	2	—	1.1	1.3	V
			+25°C	$I_C = 350\text{ mA}, I_B = 500\text{ }\mu\text{A}$	2	—	1.25	1.6	V
				$I_C = 200\text{ mA}, I_B = 350\text{ }\mu\text{A}$	2	—	1.1	1.3	V
				$I_C = 100\text{ mA}, I_B = 250\text{ }\mu\text{A}$	2	—	0.9	1.1	V
			+125°C	$I_C = 350\text{ mA}^\dagger, I_B = 500\text{ }\mu\text{A}$	2	—	1.6	1.8	V
				$I_C = 200\text{ mA}^\dagger, I_B = 350\text{ }\mu\text{A}$	2	—	1.3	1.5	V
				$I_C = 100\text{ mA}, I_B = 250\text{ }\mu\text{A}$	2	—	1.1	1.3	V
Input Current	$I_{IN(ON)}$	ULS2822*		$V_{IN} = 17\text{ V}$	3	480	850	1300	μA
		ULS2823*		$V_{IN} = 3.85\text{ V}$	3	650	930	1350	μA
		ULS2824*		$V_{IN} = 5.0\text{ V}$	3	240	350	500	μA
				$V_{IN} = 12\text{ V}$	3	650	1000	1450	μA
		ULS2825*		$V_{IN} = 3.0\text{ V}$	3	—	1500	2400	μA
	$I_{IN(OFF)}$	All	+125°C	$I_C = 500\text{ }\mu\text{A}$	4	20	50	—	μA
Input Voltage	$V_{IN(ON)}$	ULS2822*	-55°C	$V_{CE} = 2.0\text{ V}, I_C = 300\text{ mA}$	5	—	—	18	V
			+125°C	$V_{CE} = 2.0\text{ V}, I_C = 300\text{ mA}^\dagger$	5	—	—	13	V
		ULS2823*	-55°C	$V_{CE} = 2.0\text{ V}, I_C = 200\text{ mA}$	5	—	—	3.3	V
				$V_{CE} = 2.0\text{ V}, I_C = 250\text{ mA}$	5	—	—	3.6	V
				$V_{CE} = 2.0\text{ V}, I_C = 300\text{ mA}$	5	—	—	3.9	V
			+125°C	$V_{CE} = 2.0\text{ V}, I_C = 200\text{ mA}^\dagger$	5	—	—	2.4	V
		$V_{CE} = 2.0\text{ V}, I_C = 250\text{ mA}^\dagger$	5	—	—	2.7	V		
		$V_{CE} = 2.0\text{ V}, I_C = 300\text{ mA}^\dagger$	5	—	—	3.0	V		

*Complete part number includes a final letter to indicate package (H = ceramic/metal side-brazed, R = ceramic/glass cer-DIP).

Continued next page...

NOTE 1: All limits stated apply to the complete Darlington series except as specified for a single device type.

NOTE 2: The $I_{IN(OFF)}$ current limit guarantees against partial turn-on of the output.

NOTE 3: The $V_{IN(ON)}$ voltage limit guarantees a minimum output sink current per the specified test conditions.

† Pulse Test, $t_p \leq 1\text{ }\mu\text{s}$, see graph.

2801 THRU 2825 HIGH VOLTAGE, HIGH CURRENT DARLINGTON ARRAYS

T-43-25

ULS2821H/R THRU ULS2825H/R ELECTRICAL CHARACTERISTICS continued

Characteristic	Symbol	Applicable Devices	Test Conditions			Limits			
			Temp.	Voltage/Current	Fig.	Min.	Typ.	Max.	Units
Input Voltage (cont.)	$V_{IN(ON)}$	ULS2824*	-55°C	$V_{CE} = 2.0\text{ V}, I_C = 125\text{ mA}$	5	—	—	6.0	V
				$V_{CE} = 2.0\text{ V}, I_C = 200\text{ mA}$	5	—	—	8.0	V
				$V_{CE} = 2.0\text{ V}, I_C = 275\text{ mA}$	5	—	—	10	V
				$V_{CE} = 2.0\text{ V}, I_C = 350\text{ mA}$	5	—	—	12	V
			+125°C	$V_{CE} = 2.0\text{ V}, I_C = 125\text{ mA}$	5	—	—	5.0	V
				$V_{CE} = 2.0\text{ V}, I_C = 200\text{ mA}^\dagger$	5	—	—	6.0	V
				$V_{CE} = 2.0\text{ V}, I_C = 275\text{ mA}^\dagger$	5	—	—	7.0	V
				$V_{CE} = 2.0\text{ V}, I_C = 350\text{ mA}^\dagger$	5	—	—	8.0	V
ULS2825*	-55°C	$V_{CE} = 2.0\text{ V}, I_C = 350\text{ mA}$	5	—	—	3.0	V		
	+125°C	$V_{CE} = 2.0\text{ V}, I_C = 350\text{ mA}^\dagger$	5	—	—	2.4	V		
D-C Forward Current Transfer Ratio	h_{FE}	ULS2821*	-55°C	$V_{CE} = 2.0\text{ V}, I_C = 350\text{ mA}$	2	500	—	—	—
			+25°C	$V_{CE} = 2.0\text{ V}, I_C = 350\text{ mA}$	2	1000	—	—	—
Turn-On Delay	t_{PLH}	All	+25°C		8	—	250	1000	ns
Turn-Off Delay	t_{PHL}	All	+25°C		8	—	250	1000	ns
Clamp Diode Leakage Current	I_R	All		$V_R = 95\text{ V}$	6	—	—	50	μA
Clamp Diode Forward Voltage	V_F	All		$I_F = 350\text{ mA}^\dagger$	7	—	1.7	2.0	V

*Complete part number includes a final letter to indicate package (H = ceramic/metal side-brazed, R = ceramic/glass cer-DIP).

NOTE 1: All limits stated apply to the complete Darlington series except as specified for a single device type.

NOTE 2: The $I_{IN(OFF)}$ current limit guarantees against partial turn-on of the output.

NOTE 3: The $V_{IN(ON)}$ voltage limit guarantees a minimum output sink current per the specified test conditions.

† Pulse Test, $t_p \leq 1\ \mu\text{s}$, see graph.

2801 THRU 2825 HIGH VOLTAGE, HIGH-CURRENT DARLINGTON ARRAYS

TEST FIGURES

T-43-25

FIGURE 1A

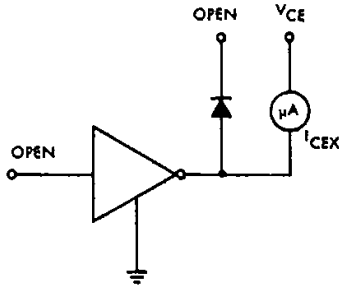

Dwg. No. A-9729A

FIGURE 1B

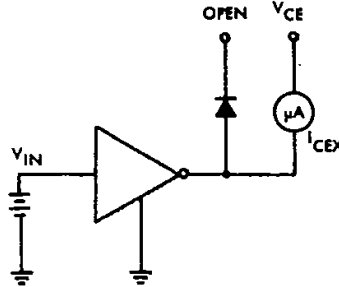

Dwg. No. A-9730A

FIGURE 2

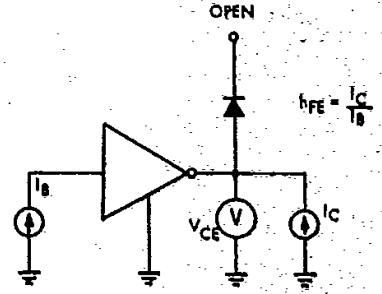

Dwg. No. A-9731

FIGURE 3

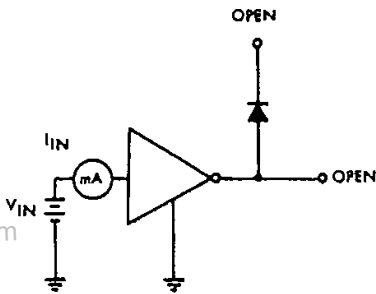

Dwg. No. A-9732

FIGURE 4

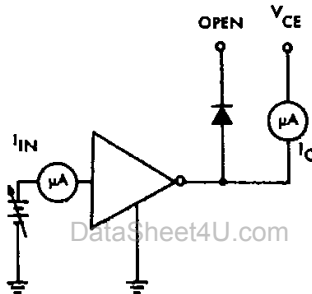

Dwg. No. A-9733A

FIGURE 5

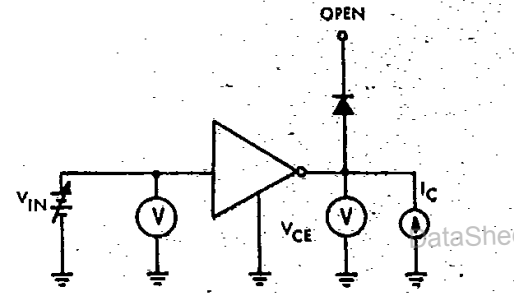

Dwg. No. A-9734A

FIGURE 6

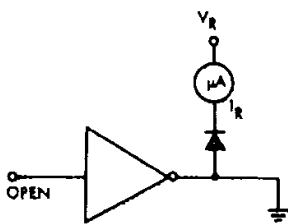

Dwg. No. A-9735A

FIGURE 7

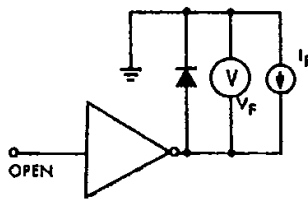

Dwg. No. A-9736

2801 THRU 2825 HIGH VOLTAGE, HIGH CURRENT DARLINGTON ARRAYS

T-43-25

	V_{IN}
Uls28X1*	3.5 V
Uls28X2*	13 V
Uls28X3*	3.5 V
Uls28X4*	12 V
Uls28X5*	3.5 V

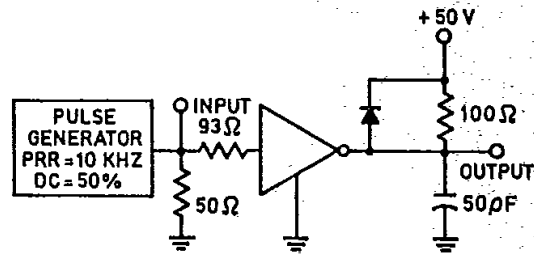

Dwg. No. A-13,273

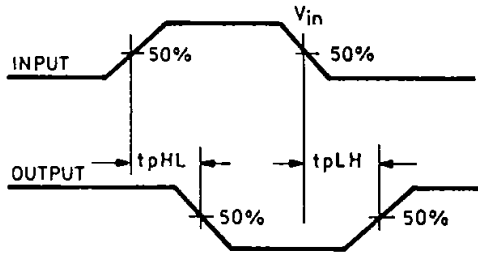

Dwg. No. A-13,272

* Complete part number includes a final letter to indicate package.

X= Digit to identify specific device. Specification shown applies to family of devices with remaining digits as shown.

FIGURE 8

COLLECTOR CURRENT
AS A FUNCTION OF SATURATION VOLTAGE

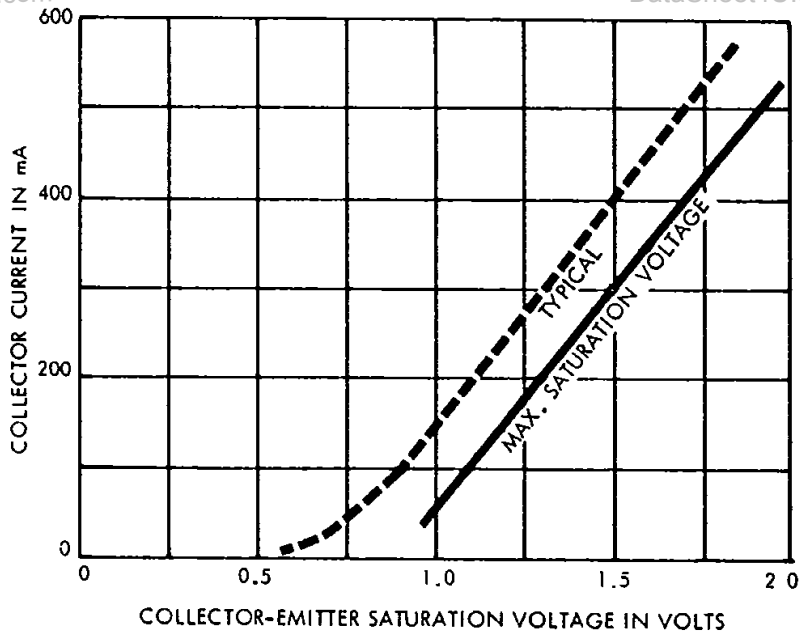

Dwg. No. A-9754C

COLLECTOR CURRENT
AS A FUNCTION OF INPUT CURRENT

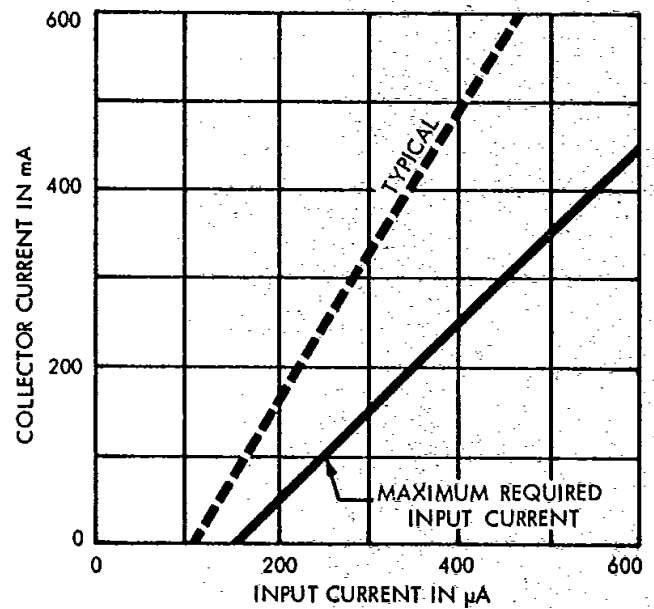

Dwg. No. A-10,872B

2801 THRU 2825 HIGH-VOLTAGE, HIGH-CURRENT DARLINGTON ARRAYS

T-43-25

ULS28XXH

RECOMMENDED PEAK CURRENT AS A FUNCTION OF DUTY CYCLE AT +50°C

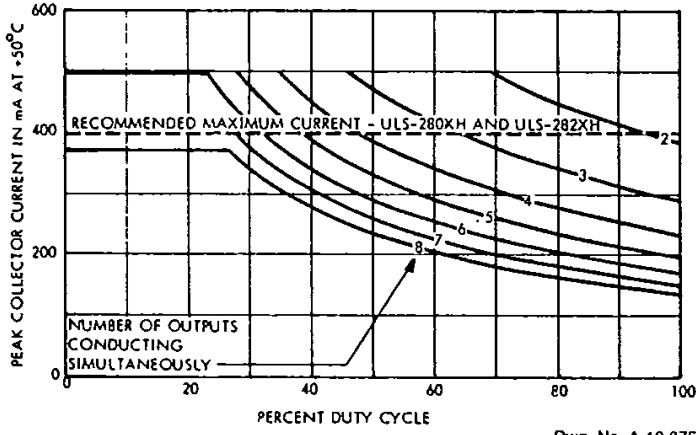

Dwg. No. A-10,875A

RECOMMENDED PEAK CURRENT AS A FUNCTION OF DUTY CYCLE AT +75°C

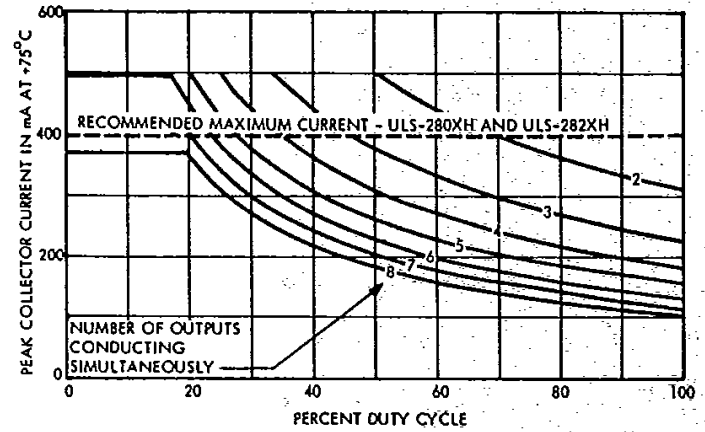

Dwg. No. A-10,876A

RECOMMENDED PEAK CURRENT AS A FUNCTION OF DUTY CYCLE AT +100°C

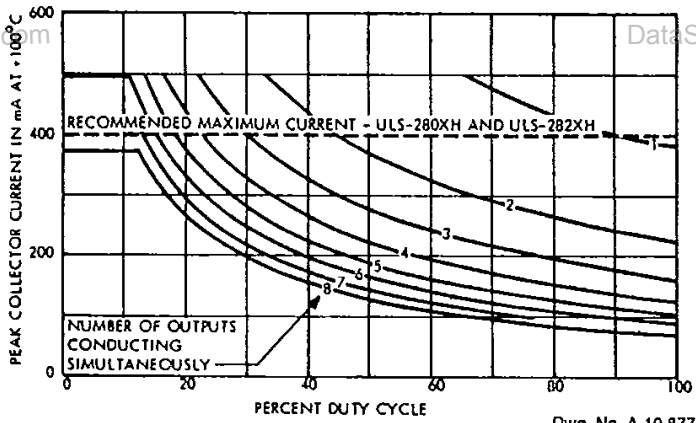

Dwg. No. A-10,877A

RECOMMENDED PEAK CURRENT AS A FUNCTION OF DUTY CYCLE AT +125°C

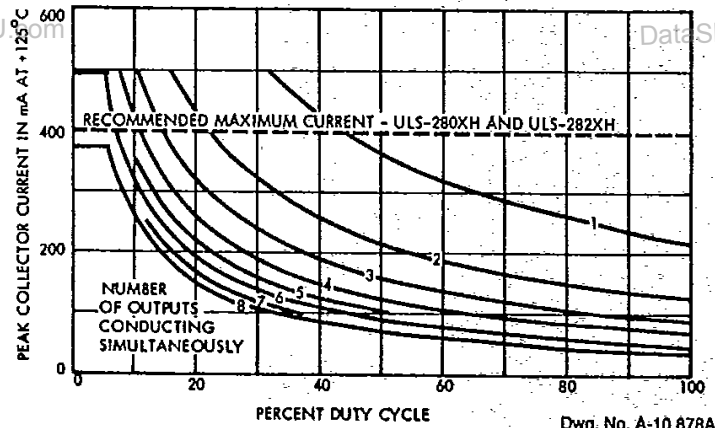

Dwg. No. A-10,878A

X = digit to identify specific device. Specification or limit shown applies to family of devices with remaining digits as shown.

2801 THRU 2825 HIGH-VOLTAGE, HIGH-CURRENT DARLINGTON ARRAYS

T-43-25

ULS28XXR

**RECOMMENDED PEAK CURRENT
AS A FUNCTION OF DUTY CYCLE AT +50°C**

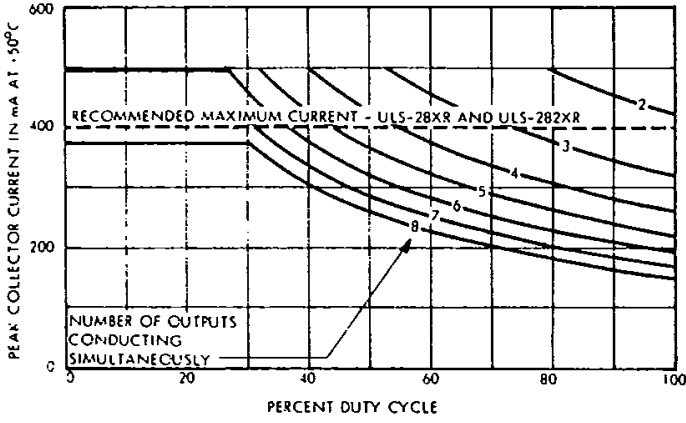

Dwg. No. A-10,870A

**RECOMMENDED PEAK CURRENT
AS A FUNCTION OF DUTY CYCLE AT +75°C**

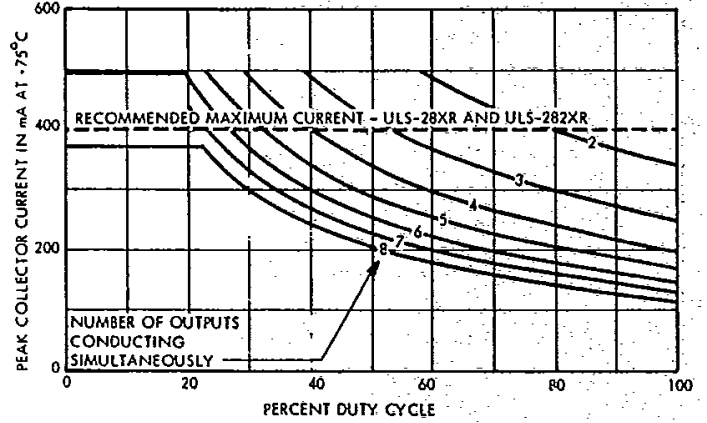

Dwg. No. A-10,871A

**RECOMMENDED PEAK CURRENT
AS A FUNCTION OF DUTY CYCLE AT +100°C**

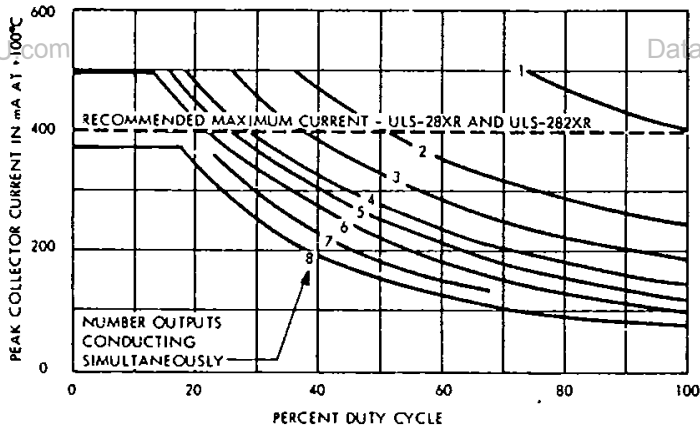

Dwg. No. A-12,466

**RECOMMENDED PEAK CURRENT
AS A FUNCTION OF DUTY CYCLE AT +125°C**

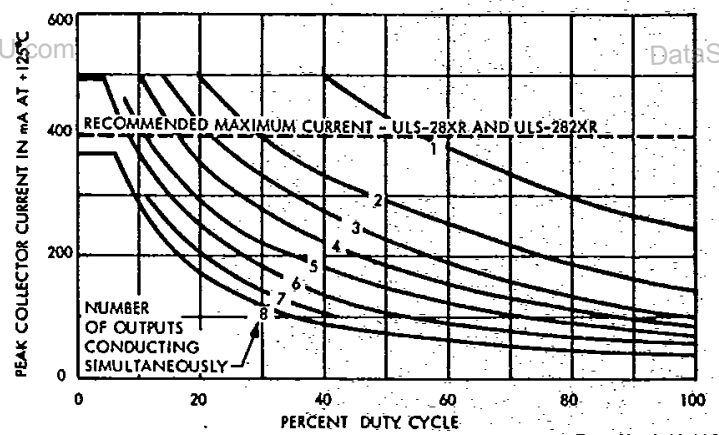

Dwg. No. A-12,467

X = digit to identify specific device. Specification or limit shown applies to family of devices with remaining digits as shown.

2801 THRU 2825 HIGH VOLTAGE, HIGH-CURRENT DARLINGTON ARRAYS

T-43-25

INPUT CURRENT AS A FUNCTION OF INPUT VOLTAGE

ULS28X2°

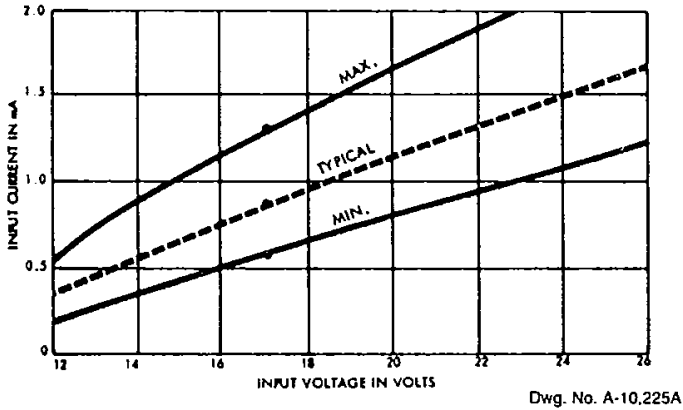

ULS28X3°

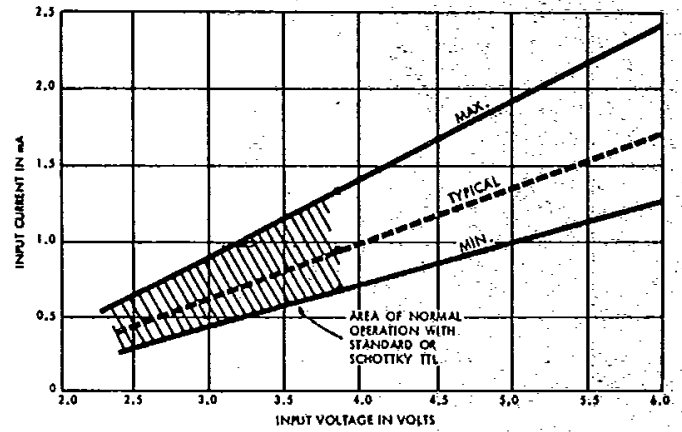

ULS28X4°

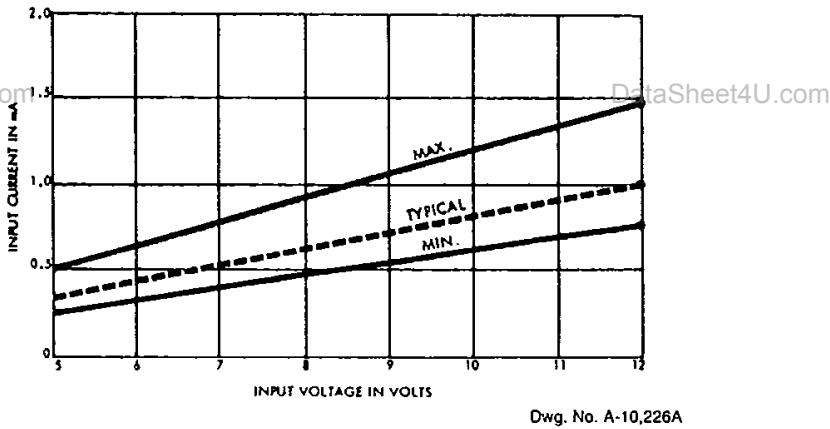

ULS28X5°

