

RoHS Compliant Product  
A suffix of "-C" specifies halogen & lead-free

## DESCRIPTION

These miniature surface mount MOSFETs utilize a high cell density trench process to provide low  $R_{DS(on)}$  and to ensure minimal power loss and heat dissipation. Typical applications are

## FEATURES

- Low  $R_{DS(on)}$  provides higher efficiency and extends battery life
- Low thermal impedance copper leadframe DFN3x3-8PP saves board space
- Fast switching speed
- High performance trench technology

## APPLICATION

DC-DC converters and power management in portable and battery-powered products such as computers, printers, PCMCIA cards, cellular and cordless telephones.

## PACKAGE INFORMATION

Package	MPQ	Leader Size
DFN3x3-8PP	3K	13 inch

### Top View

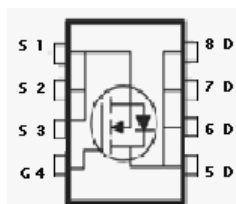

### DFN3x3-8PP

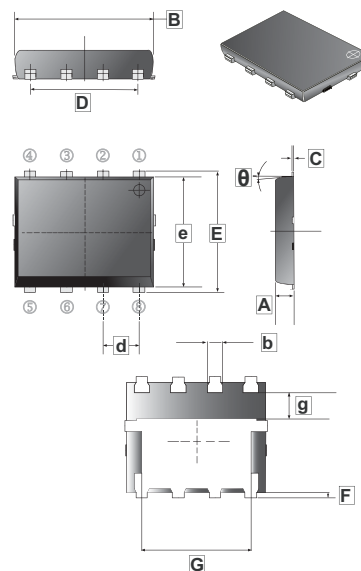

REF.	Millimeter		REF.	Millimeter	
	Min.	Max.		Min.	Max.
A	0.70	0.90	$\theta$	0°	12°
B	3.00BSC		b	0.20	0.40
C	0.10	0.25	d	0.65BSC	
D	1.80	2.3	e	3.00BSC	
E	3.2BSC		q	0.70(TYP.)	
F	0.01	0.02			
G	2.35BSC				

## MAXIMUM RATINGS ( $T_A=25^\circ\text{C}$ unless otherwise specified)

Parameter	Symbol	Ratings	Unit	
Drain-Source Voltage	$V_{DS}$	100	V	
Gate-Source Voltage	$V_{GS}$	$\pm 20$	V	
Continuous Drain Current <sup>1</sup>	$I_D$	$T_A=25^\circ\text{C}$	6.2	A
		$T_A=70^\circ\text{C}$	4.6	A
Pulsed Drain Current <sup>2</sup>	$I_{DM}$	50	A	
Continuous Source Current (Diode Conduction) <sup>1</sup>	$I_S$	5	A	
Total Power Dissipation <sup>1</sup>	$P_D$	$T_A=25^\circ\text{C}$	3.5	W
		$T_A=70^\circ\text{C}$	2	W
Operating Junction & Storage Temperature Range	$T_J, T_{STG}$	-55~150	$^\circ\text{C}$	
<b>Thermal Resistance Ratings</b>				
Thermal Resistance Junction-Ambient (Max.) <sup>1</sup>	$R_{\theta JA}$	$t \leq 10$ sec	35	$^\circ\text{C} / \text{W}$
		Steady State	81	$^\circ\text{C} / \text{W}$

Notes:

1. Surface Mounted on 1" x 1" FR4 Board.
2. Pulse width limited by maximum junction temperature.

**ELECTRICAL CHARACTERISTICS** ( $T_A=25^\circ\text{C}$  unless otherwise specified)

Parameter	Symbol	Min.	Typ.	Max.	Unit	Test Conditions
<b>Static</b>						
Gate-Threshold Voltage	$V_{GS(th)}$	1	-	-	V	$V_{DS}=V_{GS}$ , $I_D=250\mu\text{A}$
Gate-Body Leakage Current	$I_{GSS}$	-	-	$\pm 10$	$\mu\text{A}$	$V_{DS}=0$ , $V_{GS}=\pm 20\text{V}$
Zero Gate Voltage Drain Current	$I_{DSS}$	-	-	1	$\mu\text{A}$	$V_{DS}=80\text{V}$ , $V_{GS}=0$
		-	-	5		$V_{DS}=80\text{V}$ , $V_{GS}=0$ , $T_J=55^\circ\text{C}$
On-State Drain Current <sup>1</sup>	$I_{D(on)}$	3.1	-	-	A	$V_{DS}=5\text{V}$ , $V_{GS}=10\text{V}$
Drain-Source On-Resistance <sup>1</sup>	$R_{DS(ON)}$	-	-	62	m $\Omega$	$V_{GS}=10\text{V}$ , $I_D=5\text{A}$
		-	-	72		$V_{GS}=4.5\text{V}$ , $I_D=4.9\text{A}$
Forward Transconductance <sup>1</sup>	$g_{fs}$	-	10	-	S	$V_{DS}=15\text{V}$ , $I_D=5\text{A}$
Diode Forward Voltage	$V_{SD}$	-	0.73	-	V	$I_S=2.5\text{A}$ , $V_{GS}=0$
<b>Dynamic <sup>2</sup></b>						
Total Gate Charge	$Q_g$	-	12	-	nC	$V_{DS}=50\text{V}$ , $V_{GS}=4.5\text{V}$ , $I_D=5\text{A}$
Gate-Source Charge	$Q_{gs}$	-	4.1	-		
Gate-Drain Charge	$Q_{gd}$	-	6.2	-		
Input Capacitance	$C_{iss}$	-	1098	-	pF	$V_{DS}=15\text{V}$ , $V_{GS}=0$ $f=1\text{MHz}$
Output Capacitance	$C_{oss}$	-	120	-		
Reverse Transfer Capacitance	$C_{rss}$	-	76	-		
Turn-On Delay Time	$T_{d(on)}$	-	7	-	nS	$V_{DD}=50\text{V}$ $I_D=5\text{A}$ $V_{GEN}=10\text{V}$ $R_L=10\Omega$ $R_{GEN}=6\Omega$
Rise Time	$T_r$	-	11	-		
Turn-Off Delay Time	$T_{d(off)}$	-	54	-		
Fall Time	$T_f$	-	26	-		

Notes:

1. Pulse test :  $PW \leq 300\mu\text{s}$  duty cycle  $\leq 2\%$ .
2. Guaranteed by design, not subject to production testing.

**Typical Electrical Characteristics**

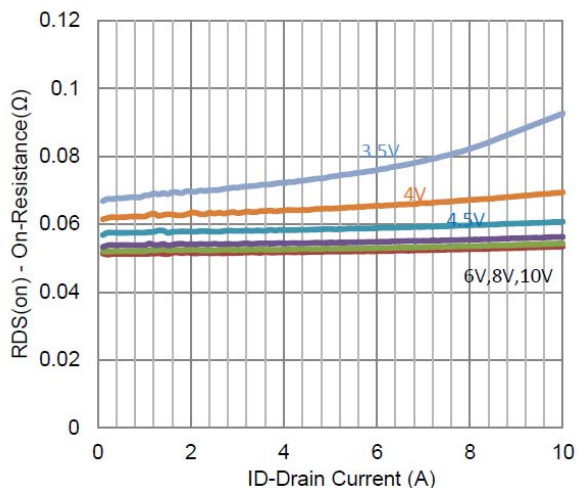

**1. On-Resistance vs. Drain Current**

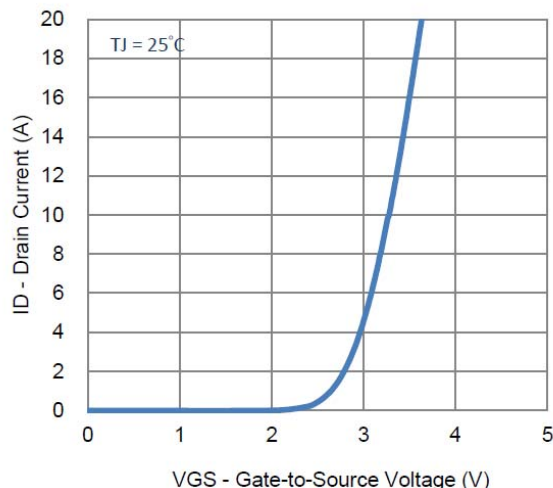

**2. Transfer Characteristics**

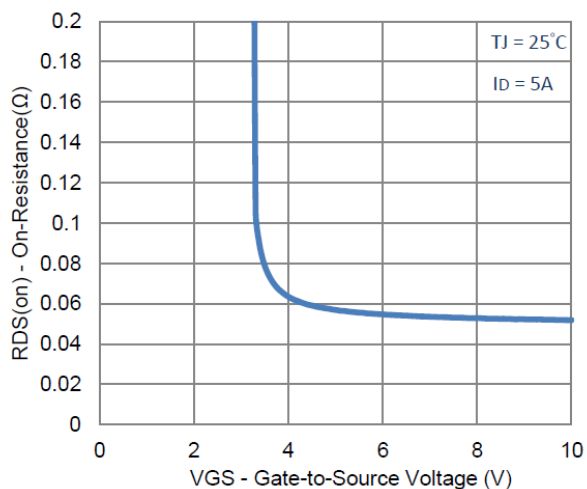

**3. On-Resistance vs. Gate-to-Source Voltage**

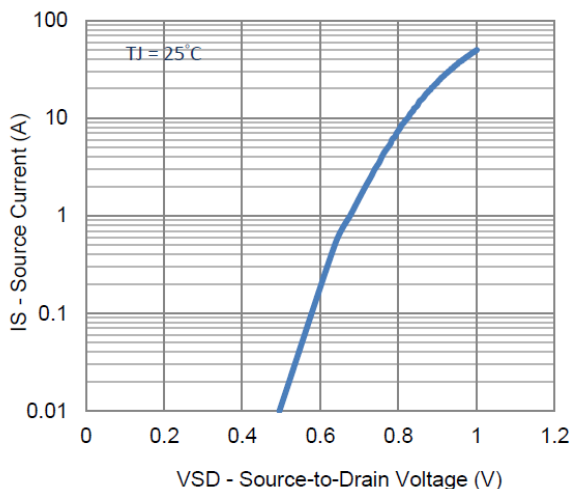

**4. Drain-to-Source Forward Voltage**

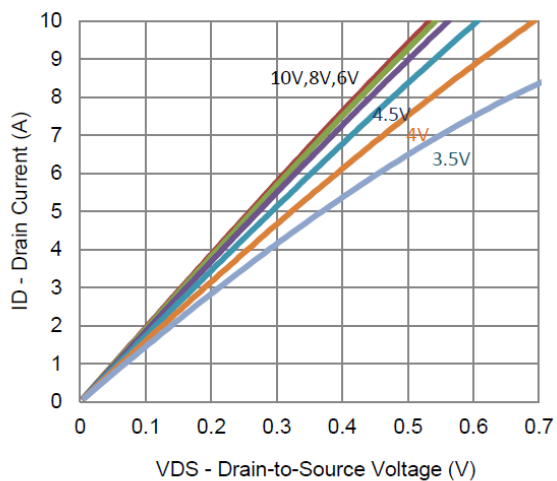

**5. Output Characteristics**

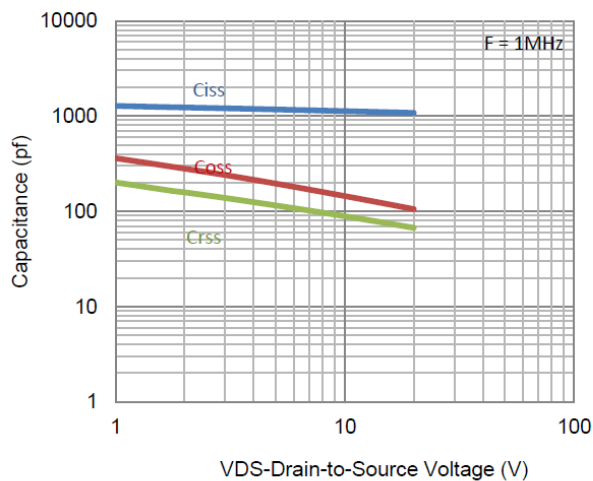

**6. Capacitance**

**Typical Electrical Characteristics**

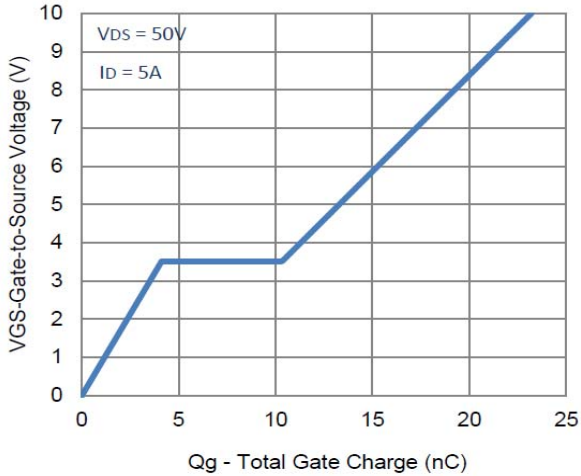

**7. Gate Charge**

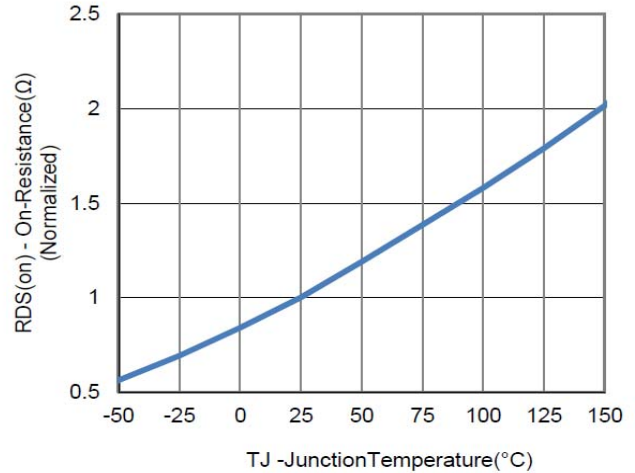

**8. Normalized On-Resistance Vs Junction Temperature**

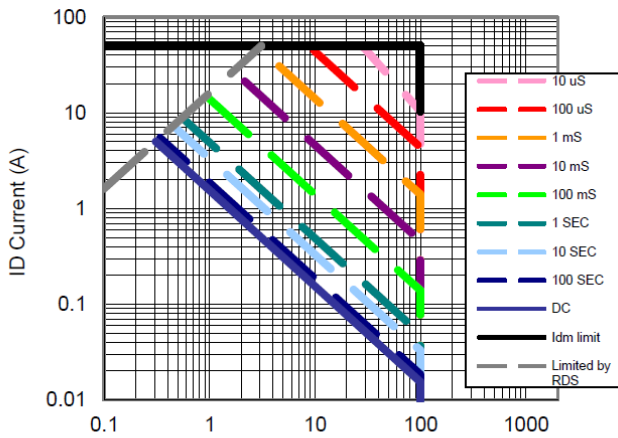

**9. Safe Operating Area**

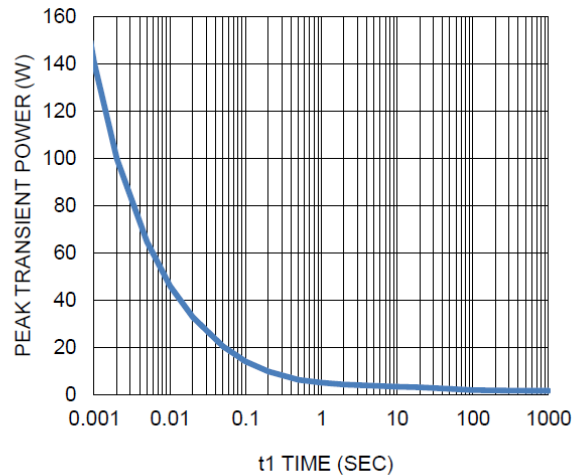

**10. Single Pulse Maximum Power Dissipation**

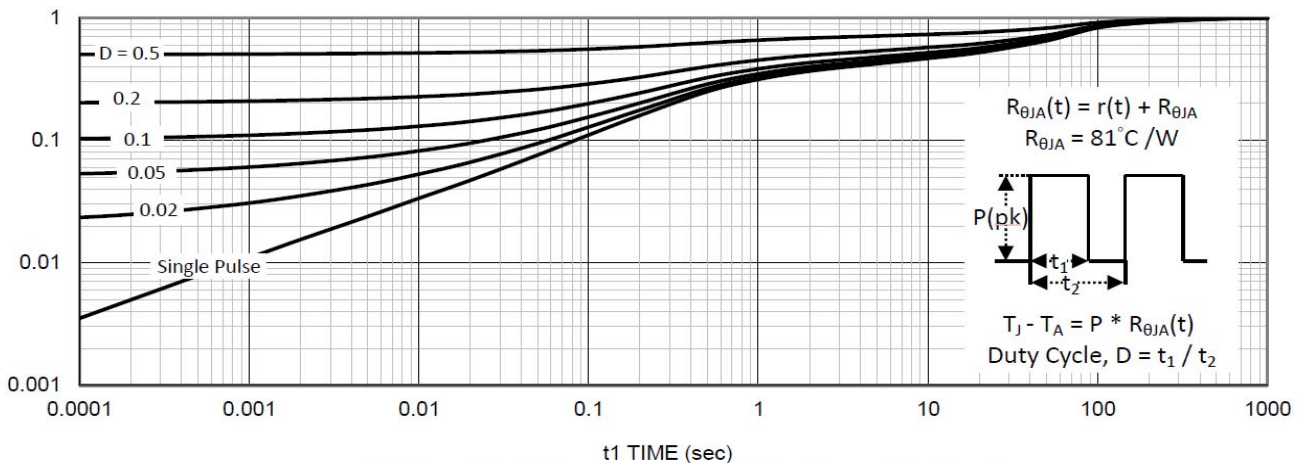

**11. Normalized Thermal Transient Junction to Ambient**