

GaAs PHEMT MMIC 1 WATT POWER AMPLIFIER, 27 - 34 GHz

Typical Applications

The HMC693 is ideal for:

- Point-to-Point Radios
- Point-to-Multi-Point Radios
- VSAT
- Military & Space

Features

- Saturated Output Power: +30 dBm @ 23% PAE
- Output IP3: +37 dBm
- Gain: 17.5 dB
- DC Supply: +5V @ 800mA
- 50 Ohm Matched Input/Output
- Die Size: 2.53 x 2.43 x 0.1 mm

Functional Diagram

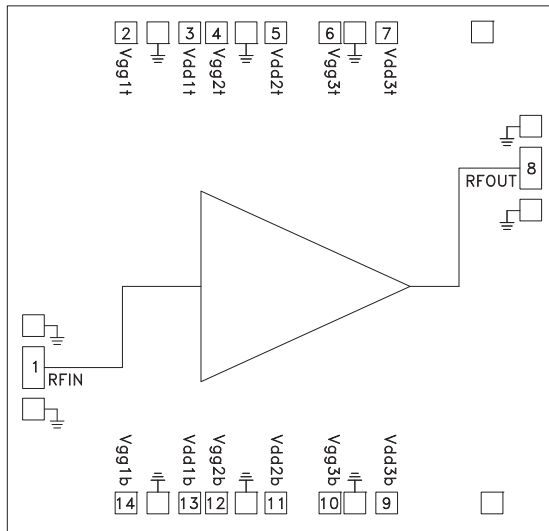

General Description

The HMC693 is a two stage GaAs PHEMT MMIC 1 Watt Power Amplifier which operates between 27 and 34 GHz. The HMC693 provides 17.5 dB of gain, and +30 dBm of saturated output power at 23% PAE from a +5V supply. The RF I/Os are DC blocked and matched to 50 Ohms for ease of integration into Multi-Chip-Modules (MCMs). All data is taken with the chip in a 50 Ohm test fixture connected via 0.025 mm (1 mil) diameter wire bonds of length 0.31 mm (12 mils).

Electrical Specifications, $T_A = +25^\circ \text{C}$,

$V_{dd} = V_{dd1-3t} = V_{dd1-3b} = +5V$, $I_{dd} = 800\text{mA}$, $V_{gg} = V_{gg1-3t} = V_{gg1-3b}$ [1]

Parameter	Min.	Typ.	Max.	Min.	Typ.	Max.	Min.	Typ.	Max.	Units
Frequency Range	27 - 29.5			29.5 - 31.4			31.4 - 34			GHz
Gain	16	18.5		15	17.5		14	16.5		dB
Gain Variation Over Temperature		0.023			0.014			0.016		dB/ °C
Input Return Loss		17			17			14		dB
Output Return Loss		34			24			19		dB
Output Power for 1 dB Compression (P1dB)	27	30		27	30		27	29		dBm
Saturated Output Power (Psat)		30.8			31			29.6		dBm
Output Third Order Intercept (IP3) ^[2]		38			38			37		dBm
Total Supply Current (Idd)		800	1100		800	1100		800	1100	mA

[1] Adjust Vgg between -2 to 0V to achieve Idd= 800mA typical.

[2] Measurement taken at 5V @ 800mA, Pin / Tone = +10 dBm

**GaAs PHEMT MMIC 1 WATT
POWER AMPLIFIER, 27 - 34 GHz**

**Broadband Gain &
Return Loss vs. Frequency**

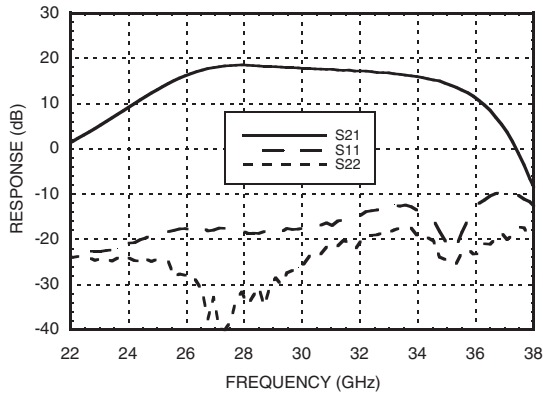

Gain vs. Frequency Over Temperature

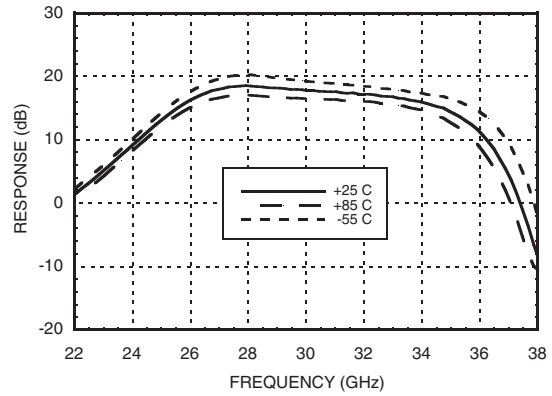

**Input Return Loss vs.
Frequency Over Temperature**

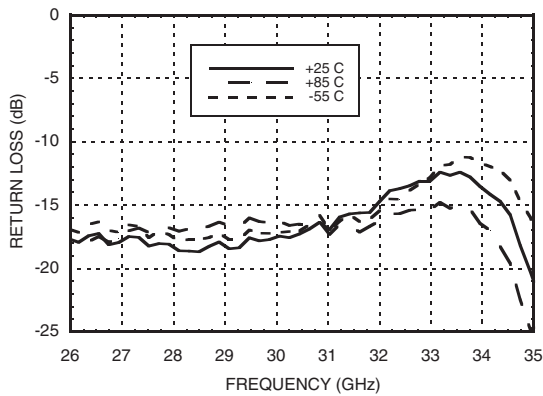

**Output Return Loss vs.
Frequency Over Temperature**

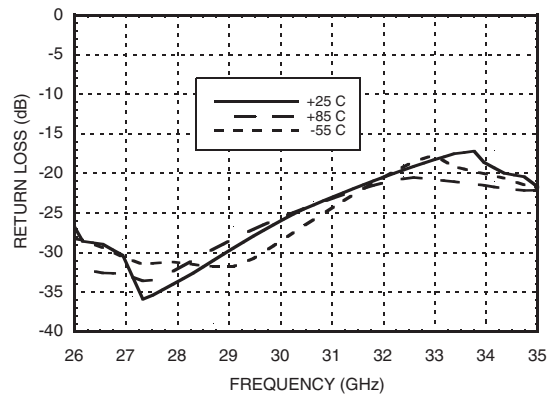

P1dB vs. Frequency Over Temperature

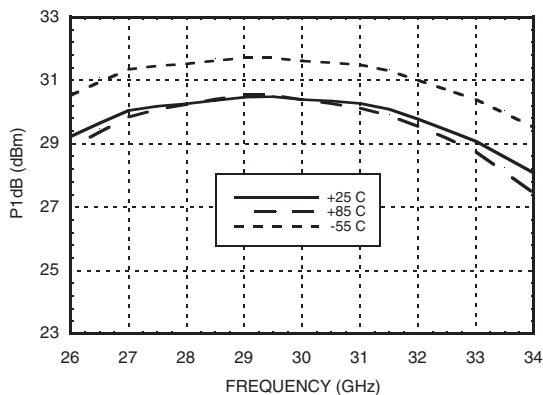

Psat vs. Frequency Over Temperature

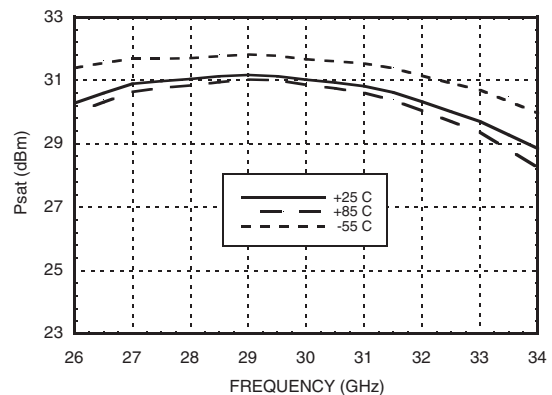

**GaAs PHEMT MMIC 1 WATT
POWER AMPLIFIER, 27 - 34 GHz**

P1dB vs. Frequency Over Current

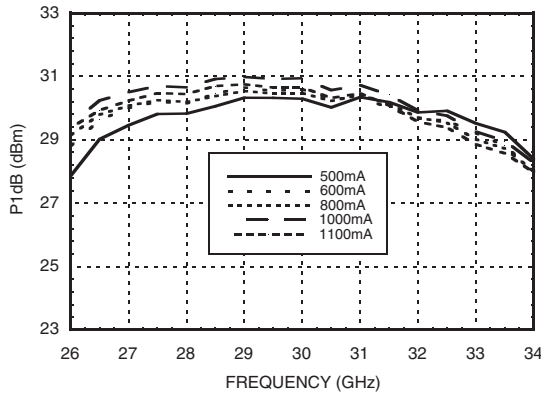

Psat vs. Frequency Over Current

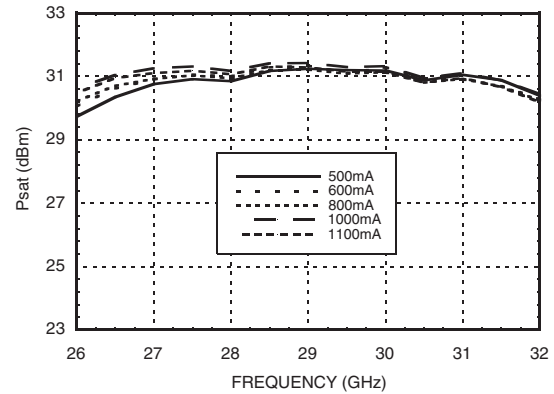

**Output IP3 vs. Temperature
5V @ 800mA, Pin/Tone = +10 dBm**

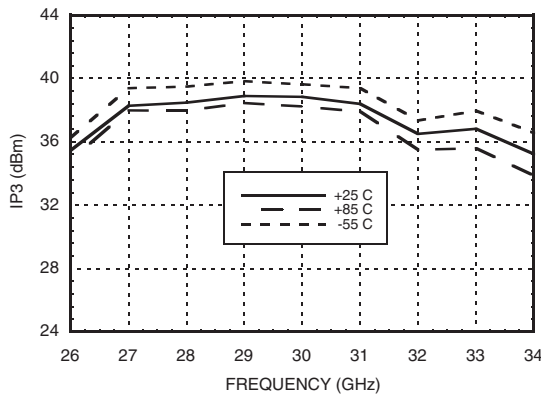

**Power Compression
@ 30 GHz, 5V @ 800mA**

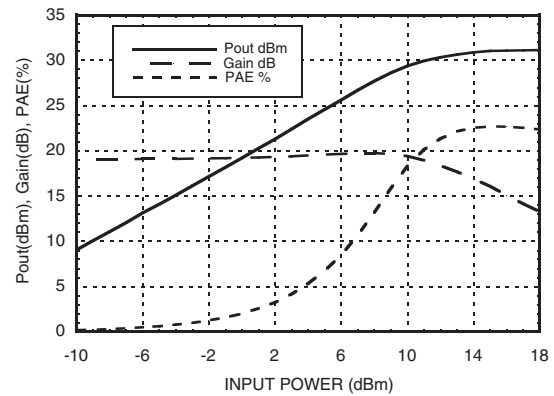

Output IM3, 5V @ 700mA

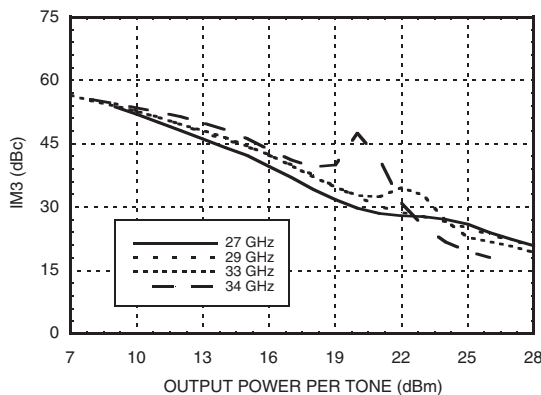

Output IM3, 5V @ 800mA

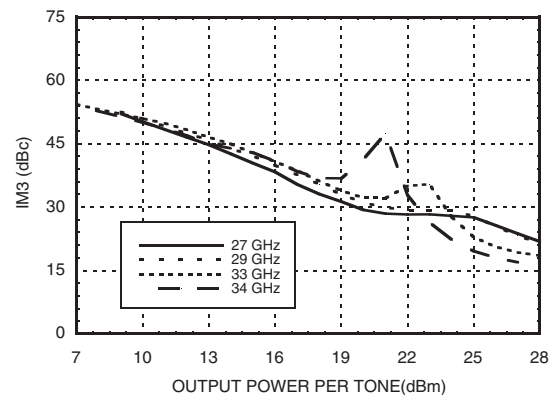

**GaAs PHEMT MMIC 1 WATT
POWER AMPLIFIER, 27 - 34 GHz**

Gain & Power vs. Supply Current @ 30 GHz

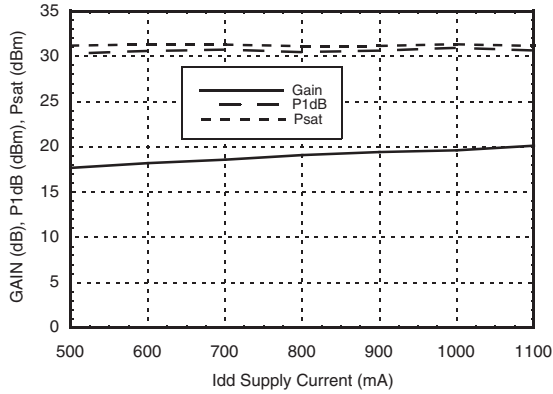

Gain & Power vs. Supply Voltage @ 30 GHz

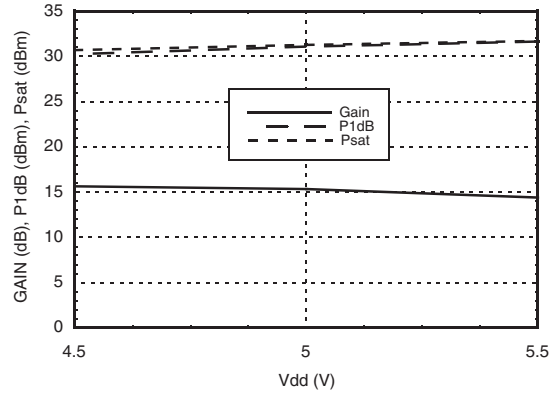

**Reverse Isolation vs. Frequency
Over Temperature, 5V @ 800mA**

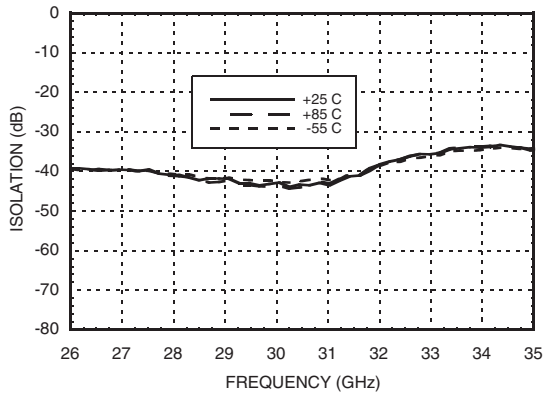

Power Dissipation, 5V @ 800mA

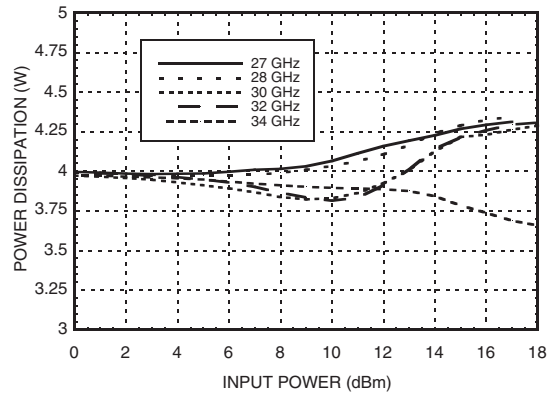

Absolute Maximum Ratings

RF Input Power (RFIN)(Vdd = 5 Vdc)	+20 dBm
Channel Temperature	175 °C
Continuous Pdiss (T= 85 °C) (derate 76.9 mW/°C above 85 °C)	6.9 W
Thermal Resistance (channel to die bottom)	13 °C/W
Storage Temperature	-65 to +150 °C
Operating Temperature	-55 to +85 °C

Typical Supply Current vs. Vdd

Vdd (V)	Idd (mA)
+4.5	785
+5.0	800
+5.5	790

Note: Amplifier will operate over full voltage ranges shown above Vgg adjusted to achieve Idd = 800mA at +5V



ELECTROSTATIC SENSITIVE DEVICE
OBSERVE HANDLING PRECAUTIONS

**GaAs PHEMT MMIC 1 WATT
POWER AMPLIFIER, 27 - 34 GHz**

Outline Drawing

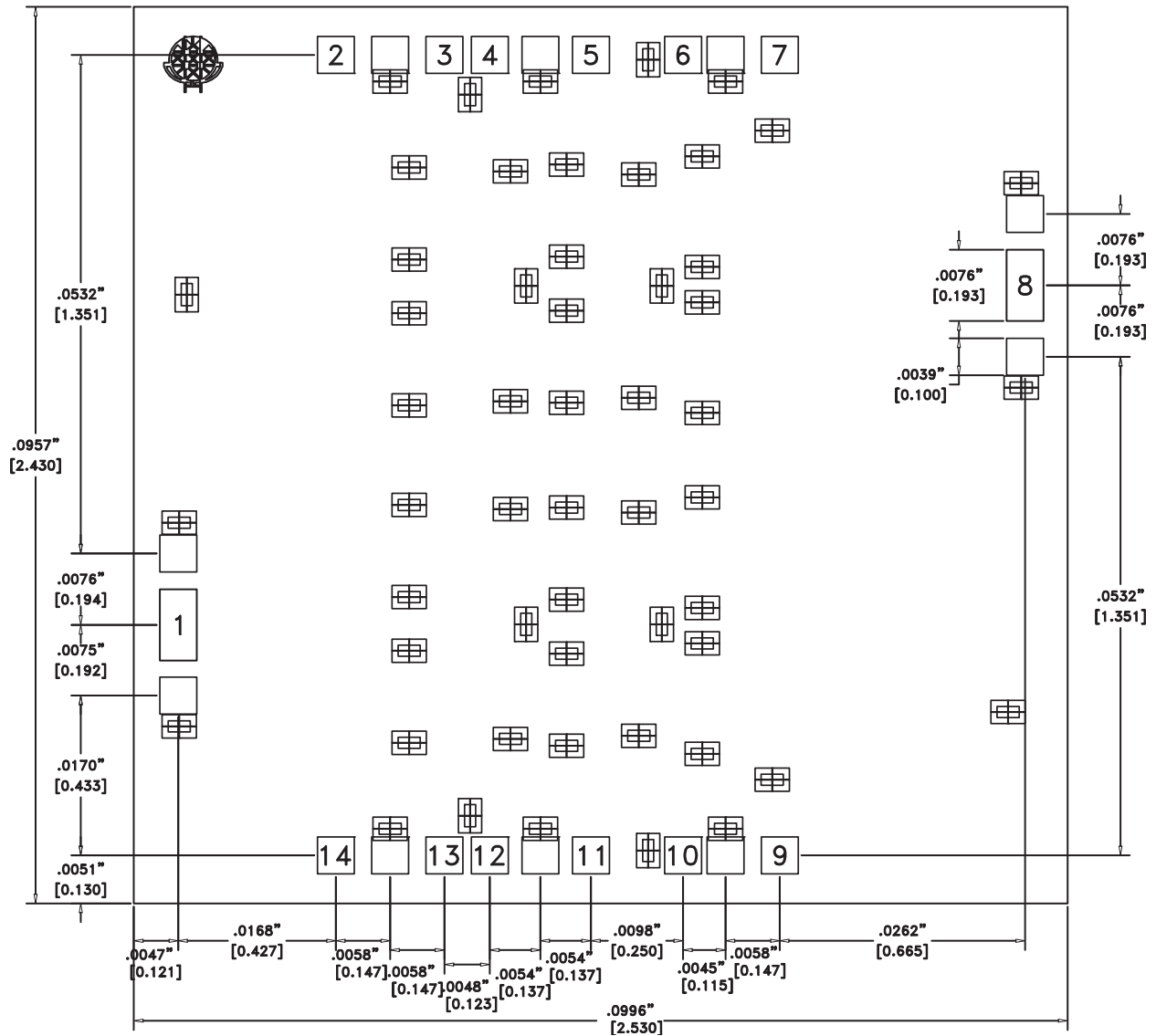

Die Packaging Information ^[1]

Standard	Alternate
GP-1 (Gel Pack)	[2]

[1] Refer to the "Packaging Information" section for die packaging dimensions.



[2] For alternate packaging information contact Hittite Microwave Corporation.

NOTES:

1. ALL DIMENSIONS ARE IN INCHES [MM]
2. DIE THICKNESS IS .004"
3. TYPICAL BOND PAD IS .004" SQUARE
4. BACKSIDE METALLIZATION: GOLD
5. BOND PAD METALLIZATION: GOLD
6. BACKSIDE METAL IS GROUND.
7. CONNECTION NOT REQUIRED FOR UNLABELED BOND PADS.
8. OVERALL DIE SIZE ± .002

**GaAs PHEMT MMIC 1 WATT
POWER AMPLIFIER, 27 - 34 GHz**

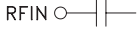
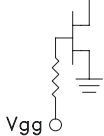
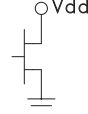
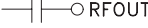
Pad Descriptions

Pad Number	Function	Description	Interface Schematic
1	RFIN	This pad is AC coupled and matched to 50 Ohm.	
2, 4, 6, 10, 12, 14	Vgg1t, Vgg2t Vgg3t, Vgg3b Vgg2b, Vgg1b	Gate control for amplifier. Adjust to achieve recommended bias current. Please follow "MMIC Amplifier Biasing Procedure" Application Note. External bypass capacitors of 100pF and 0.1uF are required	
3, 5, 7, 9, 11, 13	Vdd1t, Vdd2t Vdd3t, Vdd3b Vdd2b, Vdd1b	Power Supply voltage for amplifier. External bypass capacitors of 100pF and 0.1uF are required.	
8	RFOUT	This pad is AC coupled and matched to 50 Ohm.	
Die Bottom	GND	Die bottom must be connected to RD/DC ground.	

**GaAs PHEMT MMIC 1 WATT
POWER AMPLIFIER, 27 - 34 GHz**

Assembly Diagram

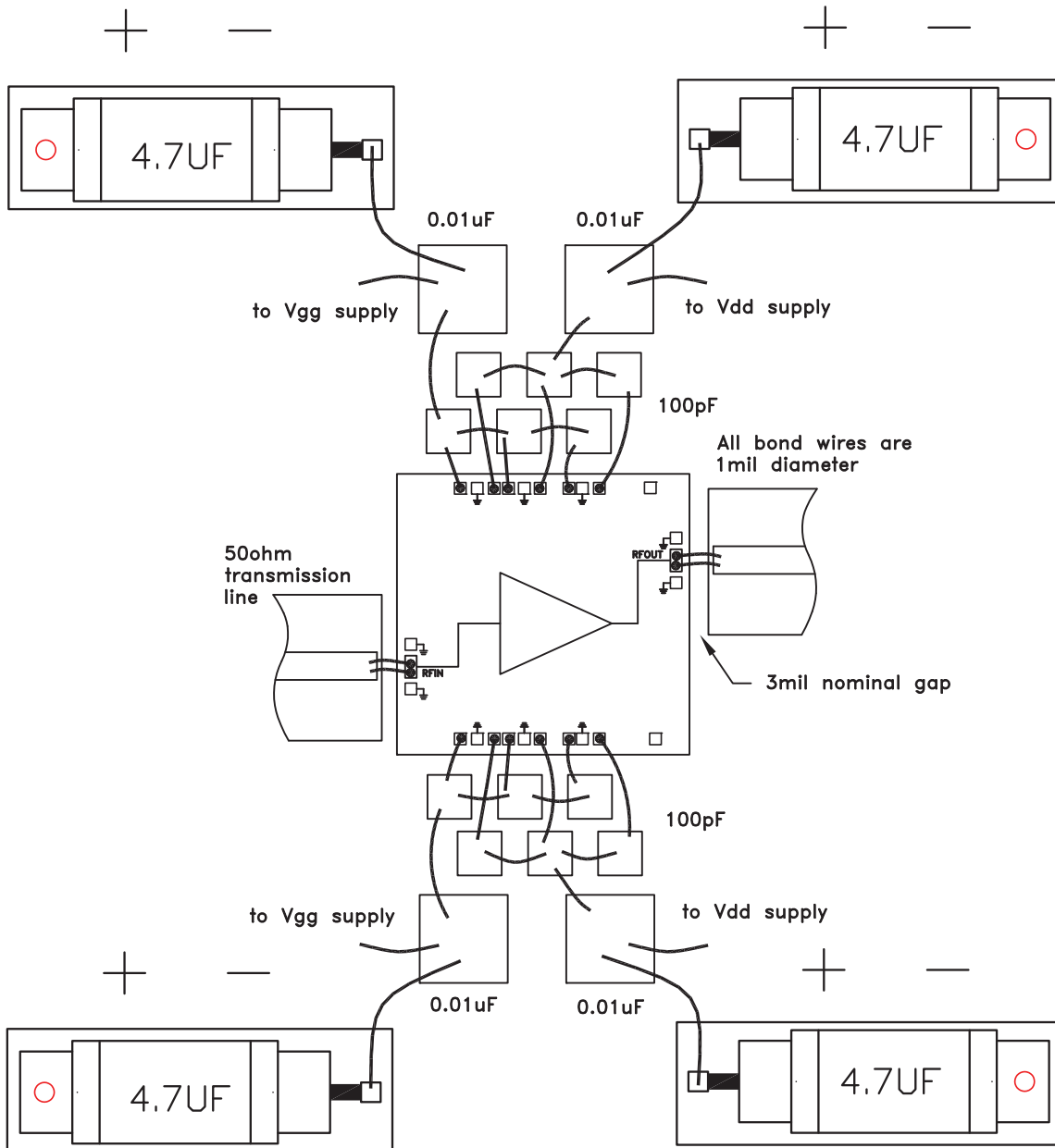

**GaAs PHEMT MMIC 1 WATT
POWER AMPLIFIER, 27 - 34 GHz**

Mounting & Bonding Techniques for Millimeterwave GaAs MMICs

The die should be attached directly to the ground plane eutectically or with conductive epoxy (see HMC general Handling, Mounting, Bonding Note).

50 Ohm Microstrip transmission lines on 0.127mm (5 mil) thick alumina thin film substrates are recommended for bringing RF to and from the chip (Figure 1). If 0.254mm (10 mil) thick alumina thin film substrates must be used, the die should be raised 0.150mm (6 mils) so that the surface of the die is coplanar with the surface of the substrate. One way to accomplish this is to attach the 0.102mm (4 mil) thick die to a 0.150mm (6 mil) thick molybdenum heat spreader (moly-tab) which is then attached to the ground plane (Figure 2).

Microstrip substrates should be located as close to the die as possible in order to minimize bond wire length. Typical die-to-substrate spacing is 0.076mm to 0.152 mm (3 to 6 mils).

Handling Precautions

Follow these precautions to avoid permanent damage.

Storage: All bare die are placed in either Waffle or Gel based ESD protective containers, and then sealed in an ESD protective bag for shipment. Once the sealed ESD protective bag has been opened, all die should be stored in a dry nitrogen environment.

Cleanliness: Handle the chips in a clean environment. DO NOT attempt to clean the chip using liquid cleaning systems.

Static Sensitivity: Follow ESD precautions to protect against > ± 250V ESD strikes.

Transients: Suppress instrument and bias supply transients while bias is applied. Use shielded signal and bias cables to minimize inductive pick-up.

General Handling: Handle the chip along the edges with a vacuum collet or with a sharp pair of bent tweezers. The surface of the chip may have fragile air bridges and should not be touched with vacuum collet, tweezers, or fingers.

Mounting

The chip is back-metallized and can be die mounted with AuSn eutectic preforms or with electrically conductive epoxy. The mounting surface should be clean and flat.

Eutectic Die Attach: A 80/20 gold tin preform is recommended with a work surface temperature of 255 °C and a tool temperature of 265 °C. When hot 90/10 nitrogen/hydrogen gas is applied, tool tip temperature should be 290 °C. DO NOT expose the chip to a temperature greater than 320 °C for more than 20 seconds. No more than 3 seconds of scrubbing should be required for attachment.

Epoxy Die Attach: Apply a minimum amount of epoxy to the mounting surface so that a thin epoxy fillet is observed around the perimeter of the chip once it is placed into position. Cure epoxy per the manufacturer's schedule.

Wire Bonding

Ball or wedge bond with 0.025mm (1 mil) diameter pure gold wire. Thermosonic wirebonding with a nominal stage temperature of 150 °C and a ball bonding force of 40 to 50 grams or wedge bonding force of 18 to 22 grams is recommended. Use the minimum level of ultrasonic energy to achieve reliable wirebonds. Wirebonds should be started on the chip and terminated on the package or substrate. All bonds should be as short as possible <0.31mm (12 mils).

