

DATA SHEET

SKY73012: 400 – 3900 MHz Direct Quadrature Demodulator

Applications

- WiMAX (802.16) receivers
- CDMA macro and pico base stations
- PCS, DCS, GSM/GPRS, and EDGE receivers
- Third Generation (3G) wireless communications
- Power amplifier feedback/linearization
- Wireless Local Loops (WLLs)
- Wireless Local Area Networks (WLANs)
- RFID readers

Features

- High IIP2 and IIP3
- Wideband RF input frequency range (400 to 3900 MHz)
- Wideband LO input frequency range (400 to 3900 MHz)
- Integrated LO balun
- Integrated LO amplifier
- On-chip I/Q phase splitter
- Differential IF output supports direct interface to A/D circuitry
- AM demodulation immunity
- Single +3.0 V supply
- RFLGA™ (32 pin, 5 x 5 mm) Pb-free package (MSL3, 260 °C per JEDEC J-STD-020)

Description

Skyworks SKY73012 is an integrated, broadband, high-dynamic range quadrature demodulator for use in various wireless communication system applications. The SKY73012 can perform quadrature demodulation of RF input signals from 400 to 3900 MHz directly to baseband frequencies. The quadrature outputs are differential and can be directly connected to most commonly available A/D converters.

The high dynamic range and second order Input Intercept Point (IIP2) value of the SKY73012 make it ideal for use in direct conversion and low Intermediate Frequency (IF) receivers.

Figure 1 shows a functional block diagram for the SKY73012. The device package and pinout for the 32-pin RF Land Grid Array (RFLGA) are shown in Figure 2.



Skyworks offers lead (Pb)-free, RoHS (Restriction of Hazardous Substances) compliant packaging.

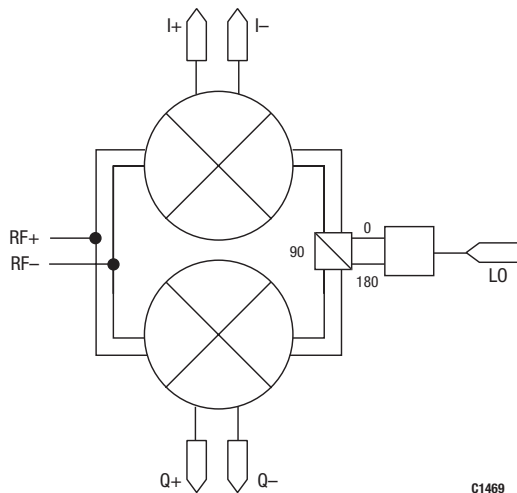

Figure 1. SKY73012 Functional Block Diagram

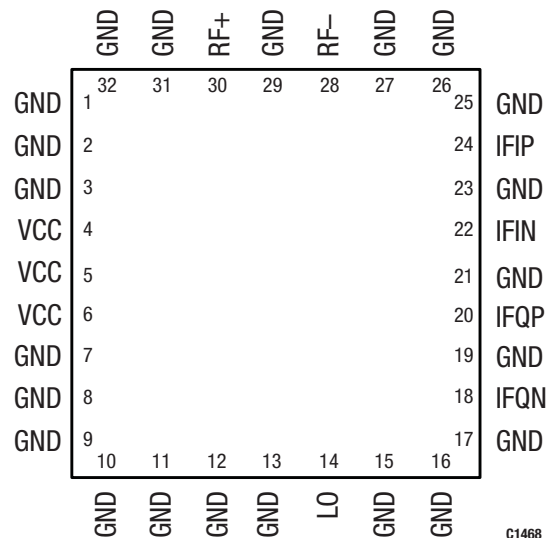

Figure 2. SKY73012 Pinout- 32-Pin RFLGA Package (Top View)

Table 1. SKY73012 Signal Descriptions

Pin #	Name	Description	Pin #	Name	Description
1	GND	Ground	17	GND	Ground
2	GND	Ground	18	IFQN	Negative quadrature IF output
3	GND	Ground	19	GND	Ground
4	VCC	+3 VDC supply	20	IFQP	Positive quadrature IF output
5	VCC	+3 VDC supply	21	GND	Ground
6	VCC	+3 VDC supply	22	IFIN	Negative in-phase IF output
7	GND	Ground	23	GND	Ground
8	GND	Ground	24	IFIP	Positive in-phase IF output
9	GND	Ground	25	GND	Ground
10	GND	Ground	26	GND	Ground
11	GND	Ground	27	GND	Ground
12	GND	Ground	28	RF-	Negative RF input
13	GND	Ground	29	GND	Ground
14	LO	LO input	30	RF+	Positive RF input
15	GND	Ground	31	GND	Ground
16	GND	Ground	32	GND	Ground

Electrical and Mechanical Specifications

Signal pin assignments and functional pin descriptions are provided in Table 1. The absolute maximum ratings of the SKY73012 are provided in Table 2 and the recommended operating conditions provided in Table 3. Electrical characteristics of the SKY73012 are provided in Table 4.

Typical performance characteristics of the SKY73012 are illustrated in Figures 3 through 59.

Figure 67 provides the package dimensions for the 32-pin RFLGA, and Figure 68 provides the tape and reel dimensions.

Package and Handling Information

Since the device package is sensitive to moisture absorption, it is baked and vacuum packed before shipping. Instructions on the shipping container label regarding exposure to moisture after the container seal is broken must be followed. Otherwise, problems related to moisture absorption may occur when the part is subjected to high temperature during solder assembly.

The SKY73012 is rated to Moisture Sensitivity Level 3 (MSL3) at 260 °C. It can be used for lead or lead-free soldering. For additional information, refer to the Skyworks Application Note, *PCB Design & SMT Assembly/Rework Guidelines for RFLGA Packages*, document number 103147.

Care must be taken when attaching this product, whether it is done manually or in a production solder reflow environment. Production quantities of this product are shipped in a standard tape and reel format. For packaging details, refer to the Skyworks Application Note *Tape and Reel*, document number 101568.

Electrostatic Discharge (ESD) Sensitivity

The SKY73012 is a static-sensitive electronic device. Do not operate or store near strong electrostatic fields. Take proper ESD precautions.

Table 2. SKY73012 Absolute Maximum Ratings
($T_A = +25\text{ }^\circ\text{C}$, unless otherwise noted)

Parameter	Symbol	Min	Typical	Max	Units
+3 V supply voltage	VCC	2.7		3.6	V
Power dissipation	P_D		210	320	mW
RF input power	P_{RFIN}			18	dBm
LO input power	P_{LOIN}		0	6	dBm
Operating case temperature	T_{OPR}	-40		+85	$^\circ\text{C}$
Storage case temperature	T_{STG}	-40	0	+125	$^\circ\text{C}$

Note: Exposure to maximum rating conditions for extended periods may reduce device reliability. There is no damage to device with only one parameter set at the limit and all other parameters set at or below their nominal values.

Table 3. SKY73012 Recommended Operating Conditions

Parameter	Symbol	Min	Typical	Max	Units
+3 V supply voltage	VCC	2.7	3.0	3.3	V
Current consumption	I_{CC}		75		mA
Operating case temperature	T_{OPR}	-40		+85	$^\circ\text{C}$

Table 4. SKY73012 Electrical Characteristics (1 of 3)
($V_{CC} = 3\text{ V}$, $I_F = 10\text{ MHz}$, L_O Input Power = 0 dBm, $T_c = 25\text{ }^\circ\text{C}$, unless otherwise noted)

Parameter	Symbol	Test Conditions	Min	Typical	Max	Units
RF input frequency range			400		3900	MHz
LO input frequency range			400		3900	MHz
IF frequency range			DC		250	MHz
I/Q amplitude imbalance			-0.3		+0.3	dB
I/Q phase error			-3	+1	+3	deg
IF output impedance (Note 1)				500		Ω
IF output DC level		Over process and operating temperature	0.95	1.20	1.55	V
900 MHz RF Input (Note 2)						
Voltage conversion gain				1		dB
Power conversion gain			-10.5	-9.0		dB
SSB Noise Figure	NF			15.5	17.5	dB
2 nd Order Input Intercept Point	IIP2		55	60		dBm
3 rd Order Input Intercept Point	IIP3		26	29		dBm
Input 1 dB compression			10.5	12		dBm
RF input VSWR		With external matching components, $Z_0 = 50\ \Omega$		1.5:1		
LO input VSWR		With external matching components, $Z_0 = 50\ \Omega$		1.5:1		
IF output noise floor				-167		dBm/Hz
RF to LO isolation				68		dB
LO to IF isolation				44		dB

Table 4. SKY73012 Electrical Characteristics (2 of 3)
(VCC = 3 V, IF = 10 MHz, LO Input Power = 0 dBm, Tc = 25 °C, unless otherwise noted)

Parameter	Symbol	Test Conditions	Min	Typical	Max	Units
1900 MHz RF Input (Note 2)						
Voltage conversion gain				1.1		dB
Power conversion gain			-10.5	-8.9		dB
SSB Noise Figure	NF			16.0	17.5	dB
2 nd Order Input Intercept Point	IIP2		49	54		dBm
3 rd Order Input Intercept Point	IIP3		23	25		dBm
Input 1 dB compression			10.0	11.2		dBm
RF input VSWR		With external matching components, Z ₀ = 50 Ω		1.5:1		
LO input VSWR		With external matching components, Z ₀ = 50 Ω		1.5:1		
IF output noise floor				-166		dBm/Hz
RF to LO isolation				61		dB
LO to IF isolation				31		dB
2600 MHz RF Input (Note 2)						
Voltage conversion gain				-0.5		dB
Power conversion gain			-11.5	-10.5		dB
SSB Noise Figure	NF			18.5	20.0	dB
2 nd Order Input Intercept Point	IIP2		43	48		dBm
3 rd Order Input Intercept Point	IIP3		23.0	25.5		dBm
Input 1 dB compression			12.0	13.5		dBm
RF input VSWR		With external matching components, Z ₀ = 50 Ω		1.5:1		
LO input VSWR		With external matching components, Z ₀ = 50 Ω		2.5:1		
IF output noise floor				-166		dBm/Hz
RF to LO isolation				55		dB
LO to IF isolation				30		dB

Table 4. SKY73012 Electrical Characteristics (2 of 3)
(VCC = 3 V, IF = 10 MHz, LO Input Power = 0 dBm, Tc = 25 °C, unless otherwise noted)

Parameter	Symbol	Test Conditions	Min	Typical	Max	Units
3600 MHz RF Input (Note 2)						
Voltage conversion gain				-0.5		dB
Power conversion gain			-11.5	-10.5		dB
SSB Noise Figure	NF			19.0	20.5	dB
2 nd Order Input Intercept Point (Note 3)	IIP2		44	50		dBm
3 rd Order Input Intercept Point (Note 3)	IIP3		19.0	21.5		dBm
Input 1 dB compression			11.5	12.5		dBm
RF input VSWR		With external matching components, Z ₀ = 50 Ω		1.5:1		
LO input VSWR		With external matching components, Z ₀ = 50 Ω		3.0:1		
IF output noise floor				-165		dBm/Hz
RF to LO isolation				58		dB
LO to IF isolation				24		dB

Note 1: Differential IFI and IFQ output impedance without the use of a 9:1 impedance ratio balun.

Note 2: The recommended LO input power level can vary from -3 dBm to +3 dBm for the 900, 1900, and 2600 MHz RF input frequencies. Above 3300 MHz, better performance is achieved by using a higher LO input power level such as +5 dBm.

Note 3: When a +5 dBm LO input power level is applied at 3600 MHz, the typical IIP2 value is 51 dBm and the typical IIP3 value is 22.5 dBm.

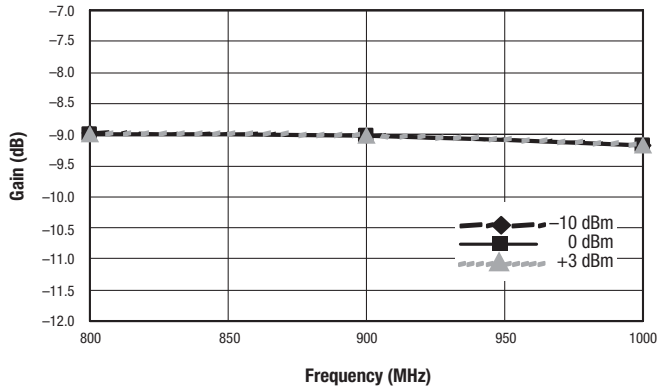

Figure 3. Power Conversion Gain vs Frequency and LO Power @ 900 MHz

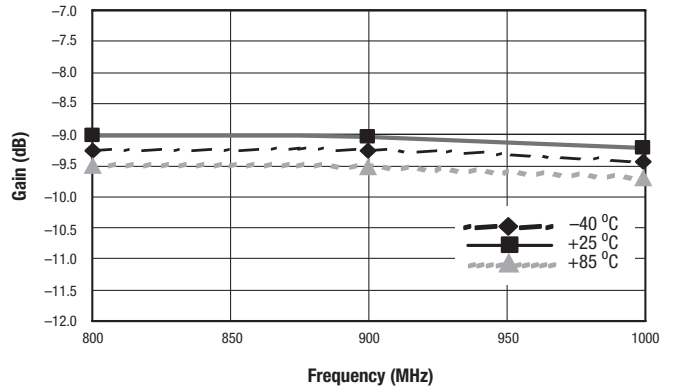

Figure 4. Power Conversion Gain vs Frequency and Temperature @ 900 MHz

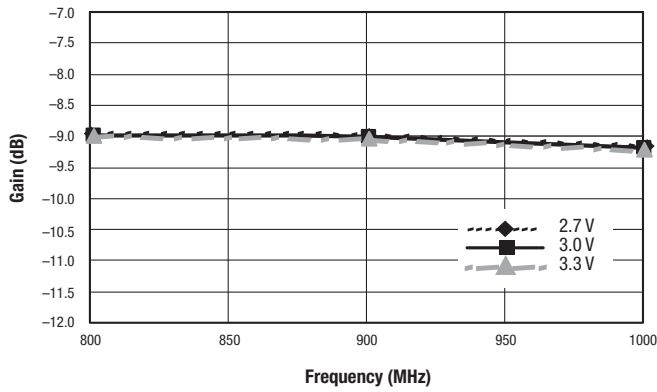

Figure 5. Power Conversion Gain vs Frequency and Supply Voltage @ 900 MHz

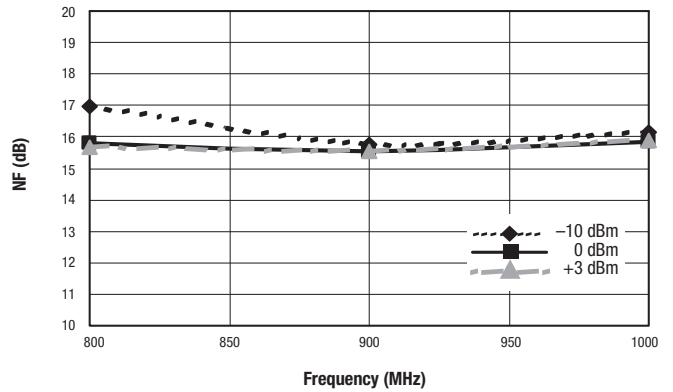

Figure 6. Noise Figure vs Frequency and LO Power @ 900 MHz

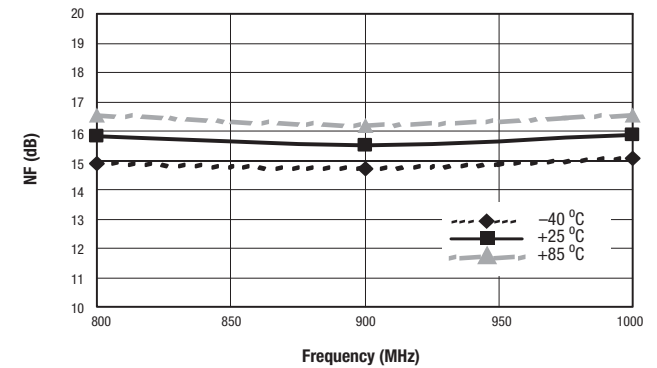

Figure 7. Noise Figure vs Frequency and Temperature @ 900 MHz

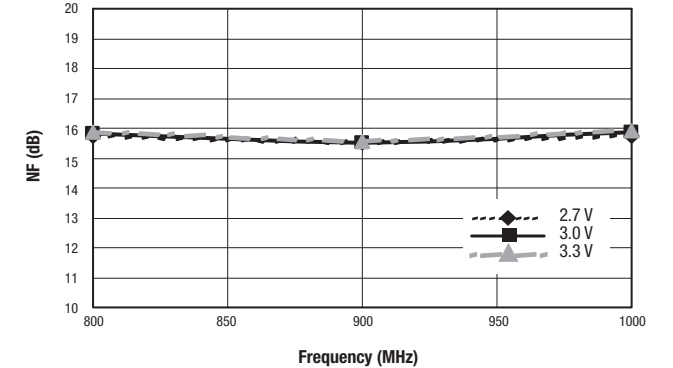

Figure 8. Noise Figure vs Frequency and Supply Voltage @ 900 MHz

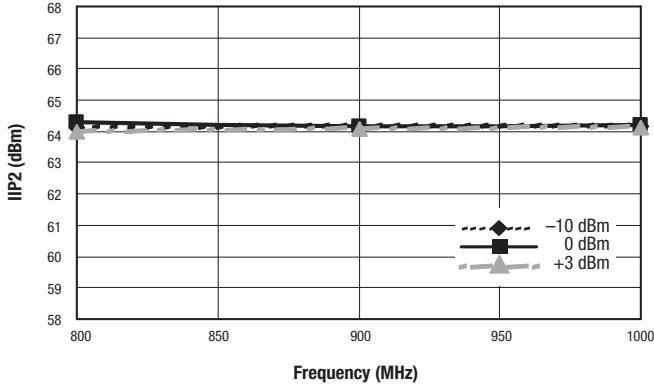

Figure 9. IIP2 vs Frequency and LO Power @ 900 MHz

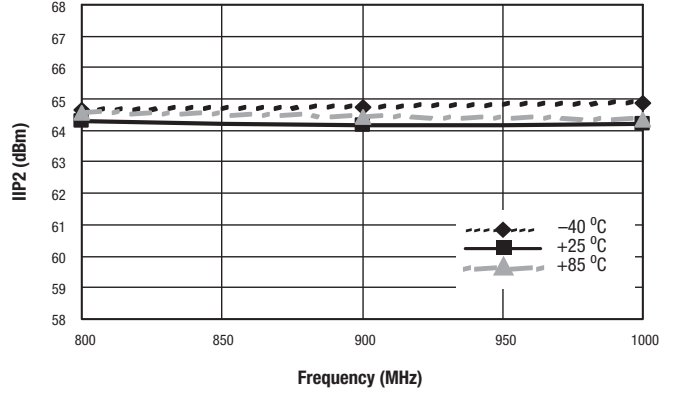

Figure 10. IIP2 vs Frequency and Temperature @ 900 MHz

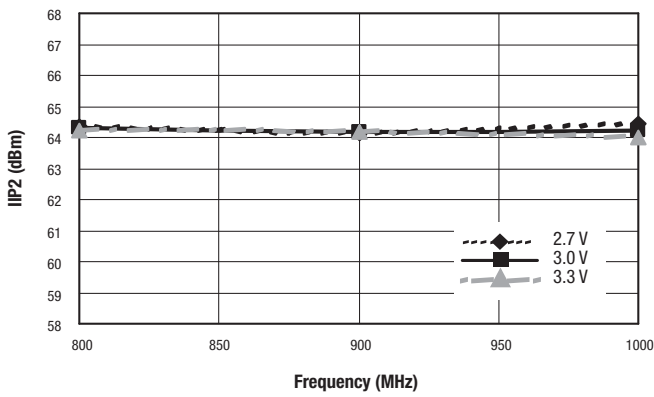

Figure 11. IIP2 vs Frequency and Supply Voltage @ 900 MHz

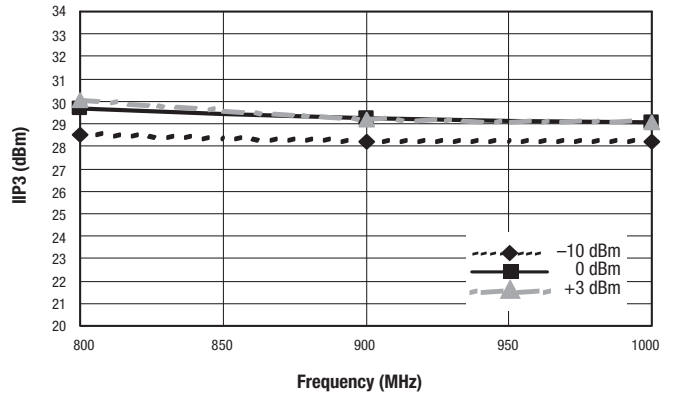

Figure 12. IIP3 vs Frequency and LO Power @ 900 MHz

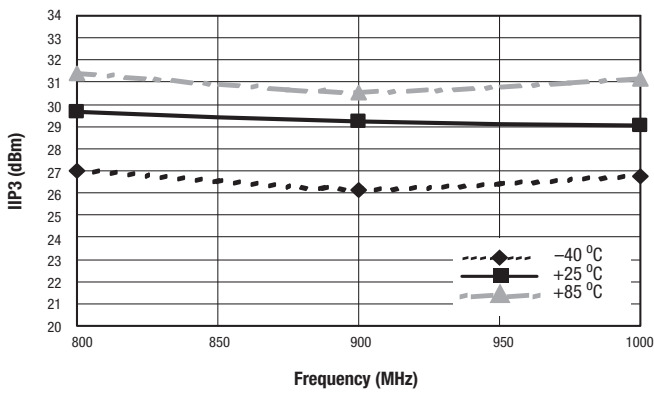

Figure 13. IIP3 vs Frequency and Temperature @ 900 MHz

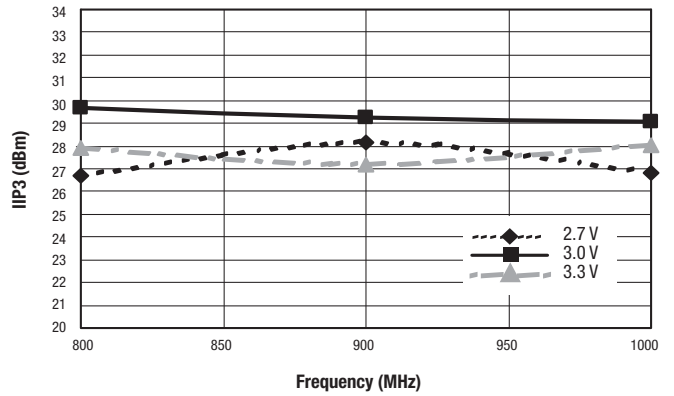

Figure 14. IIP3 vs Frequency and Supply Voltage @ 900 MHz

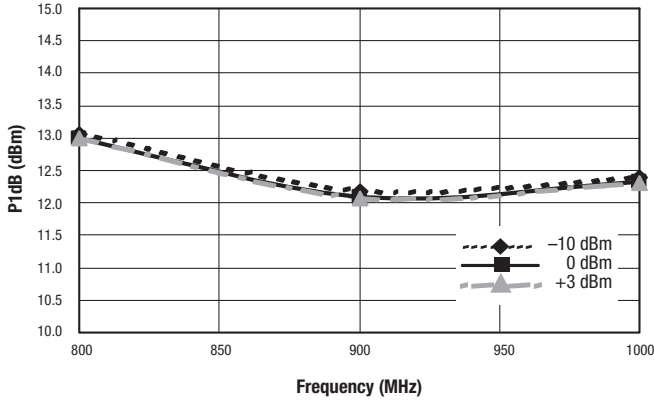

Figure 15. Input 1 dB Compression Point vs Frequency and LO Power @ 900 MHz

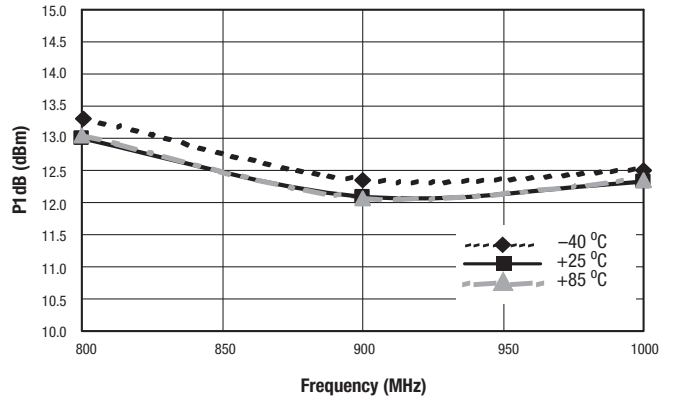

Figure 16 Input 1 dB Compression Point vs Frequency and Temperature @ 900 MHz

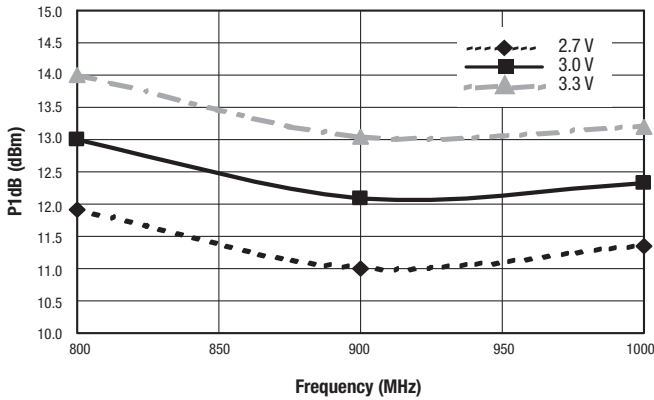

Figure 17. Input 1 dB Compression Point vs Frequency and Supply Voltage @ 900 MHz

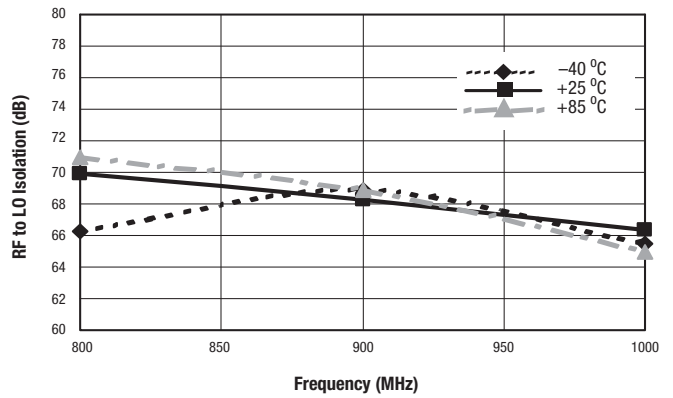

Figure 18. RF to LO Isolation vs Frequency and Temperature @ 900 MHz

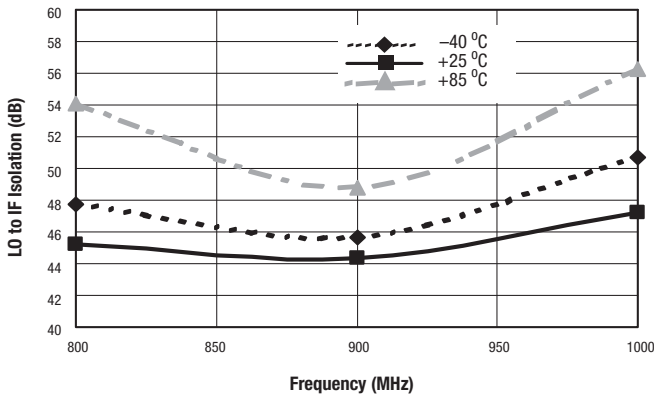

Figure 19. LO to IF Isolation vs Frequency and Temperature @ 900 MHz

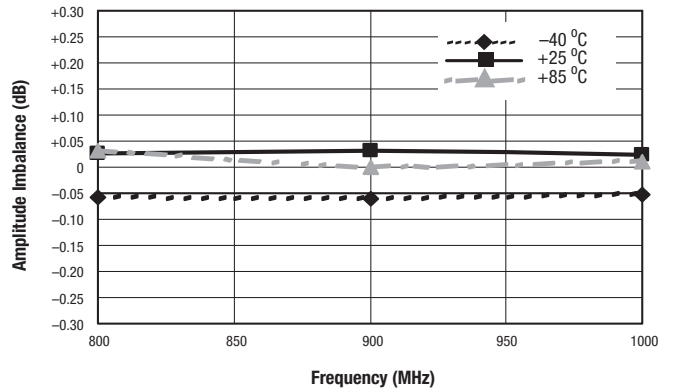

Figure 20. IQ Amplitude Imbalance vs Frequency and Temperature @ 900 MHz

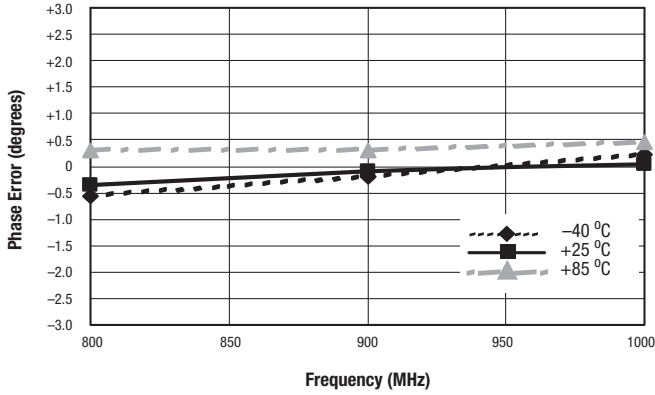

Figure 21. I/Q Phase Error vs Frequency and Temperature @ 900 MHz

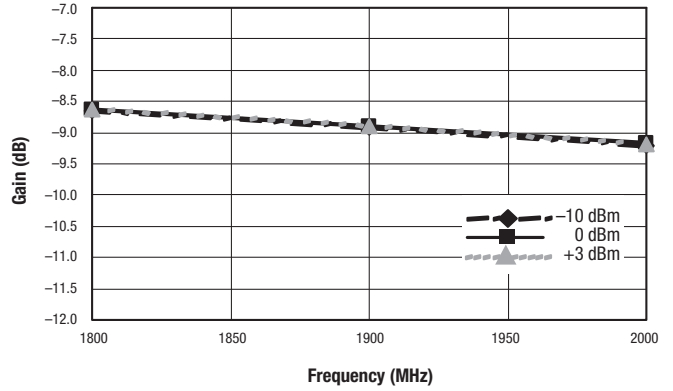

Figure 22. Power Conversion Gain vs Frequency and LO Power @ 1900 MHz

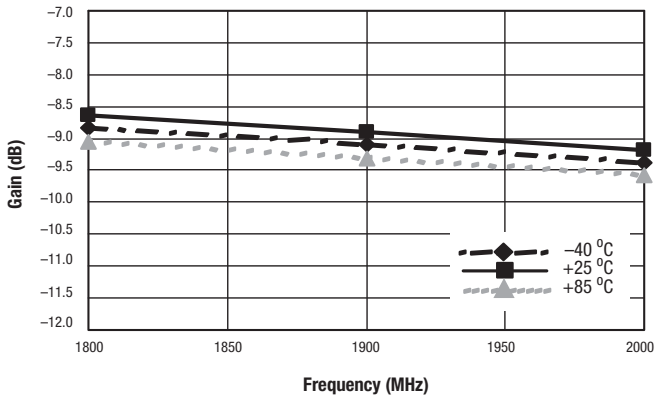

Figure 23. Power Conversion Gain vs Frequency and Temperature @ 1900 MHz

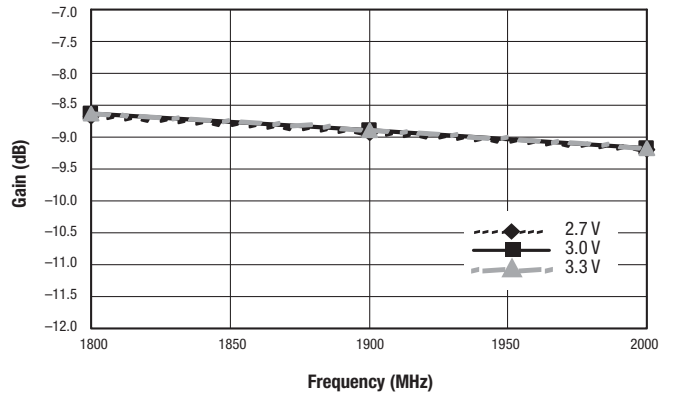

Figure 24. Power Conversion Gain vs Frequency and Supply Voltage @ 1900 MHz

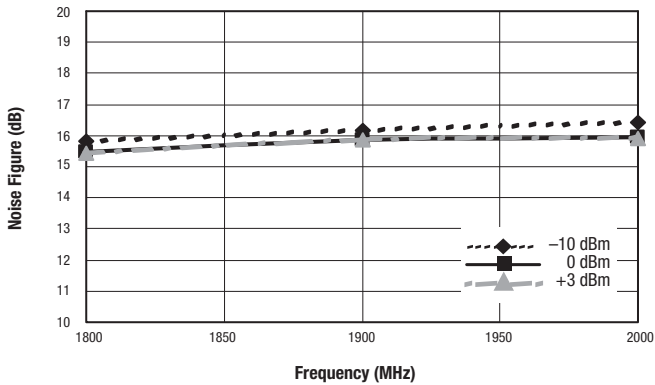

Figure 25. Noise Figure vs Frequency and LO Power @ 1900 MHz

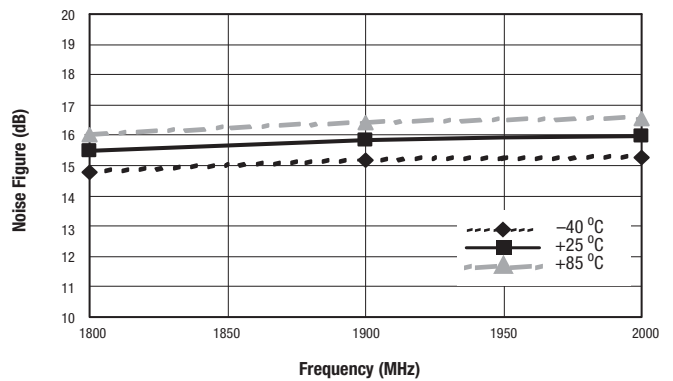

Figure 26. Noise Figure vs Frequency and Temperature @ 1900 MHz

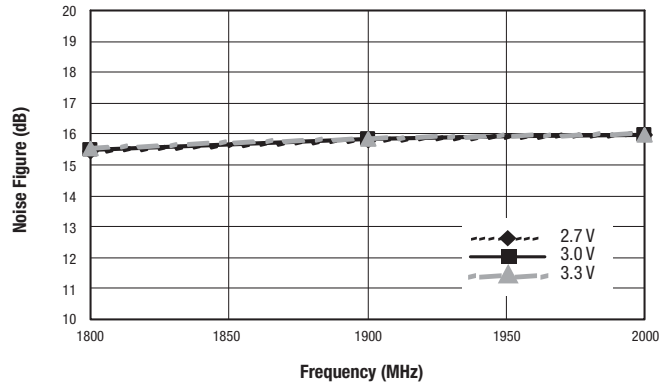

Figure 27. Noise Figure vs Frequency and Supply Voltage @ 1900 MHz

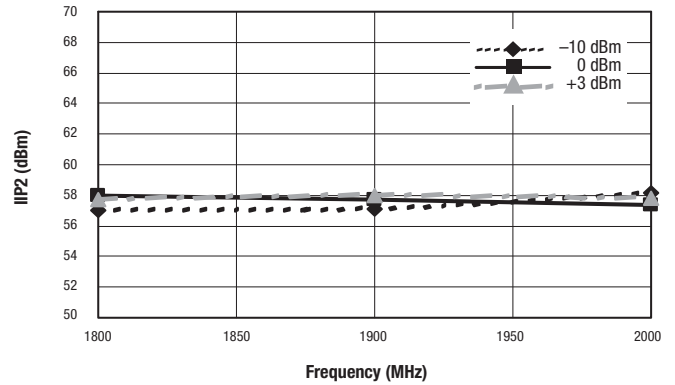

Figure 28. IIP2 vs Frequency and LO Power @ 1900 MHz

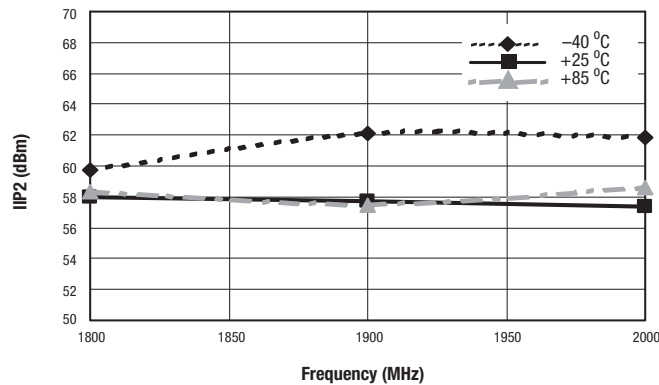

Figure 29. IIP2 vs Frequency and Temperature @ 1900 MHz

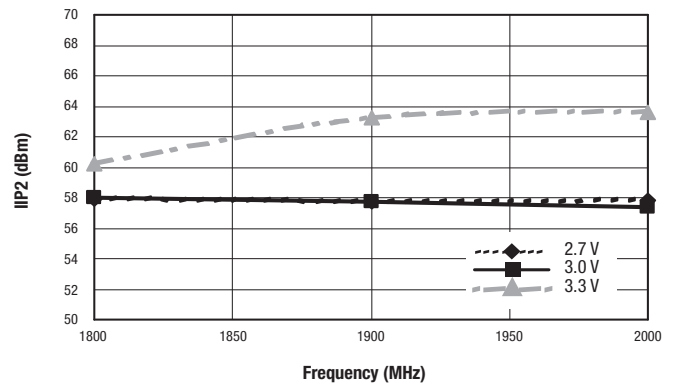

Figure 30. IIP2 vs Frequency and Supply Voltage @ 1900 MHz

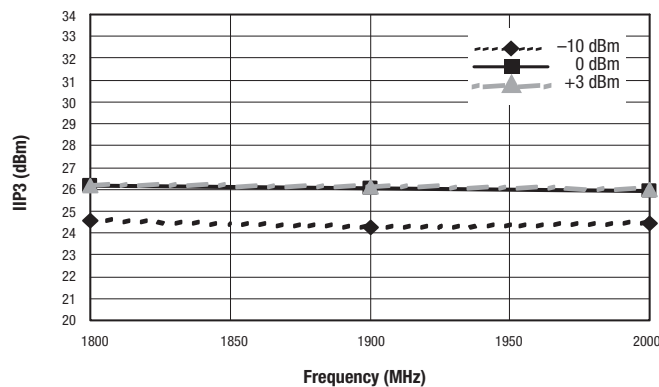

Figure 31. IIP3 vs Frequency and LO Power @ 1900 MHz

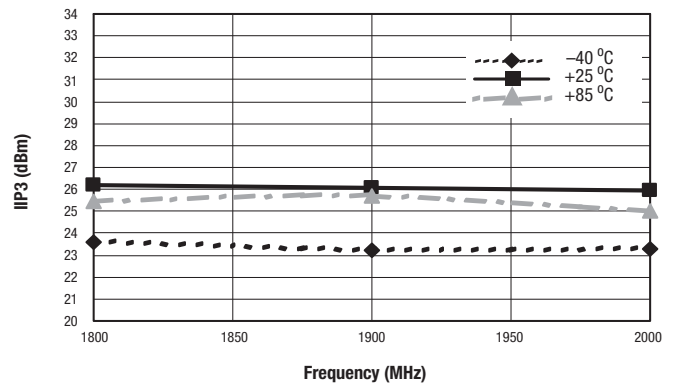

Figure 32. IIP3 vs Frequency and Temperature @ 1900 MHz

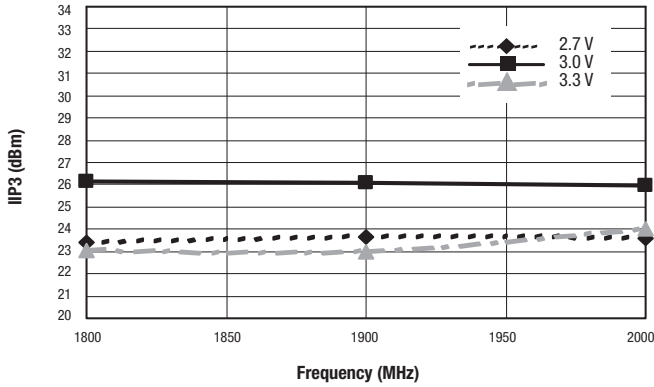

Figure 33. IIP3 vs Frequency and Supply Voltage @ 1900 MHz

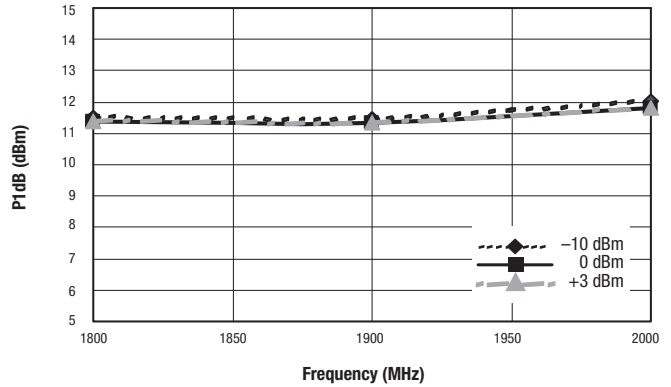

Figure 34. Input 1 dB Compression Point vs Frequency and LO Power @ 1900 MHz

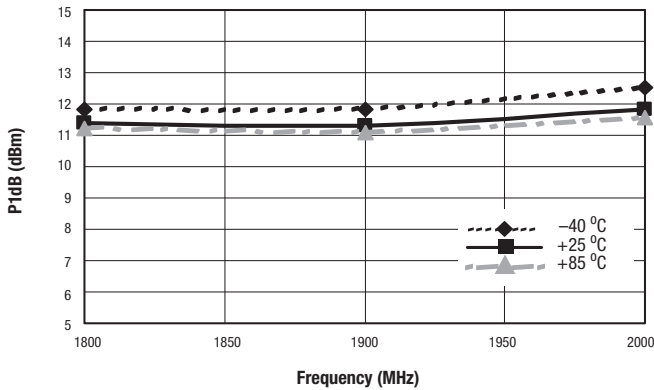

Figure 35. Input 1 dB Compression Point vs Frequency and Temperature @ 1900 MHz

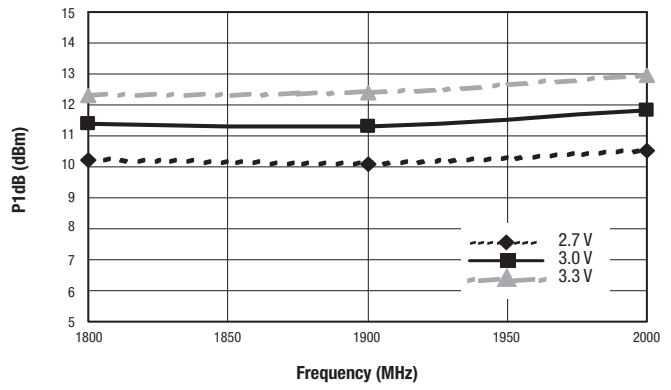

Figure 36. Input 1 dB Compression Point vs Frequency and Supply Voltage @ 1900 MHz

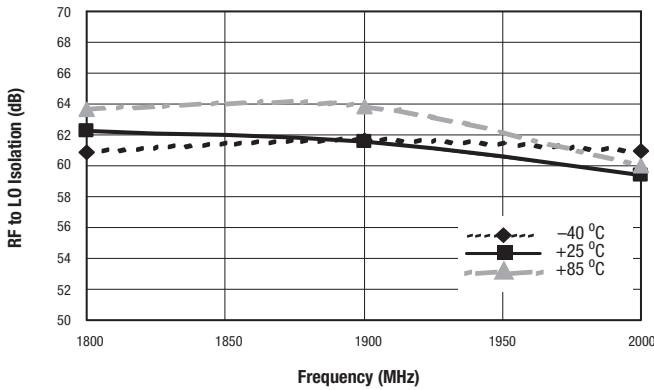

Figure 37. RF to LO Isolation vs Frequency and Temperature @ 1900 MHz

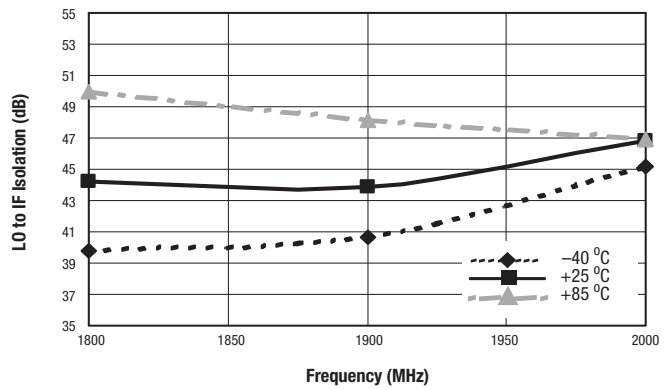

Figure 38. LO to IF Isolation vs Frequency and Temperature @ 1900 MHz

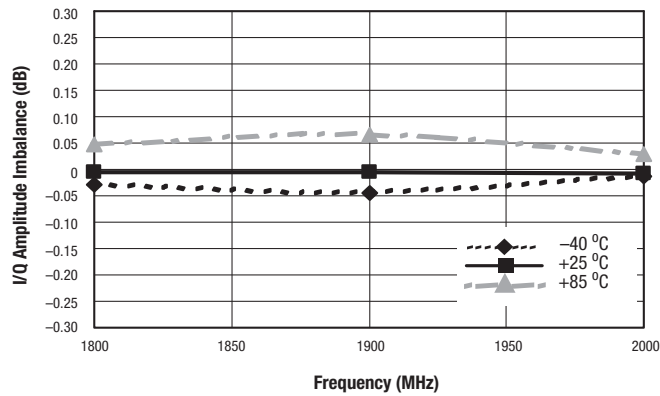

Figure 39. I/Q Amplitude Imbalance vs Frequency and Temperature @ 1900 MHz

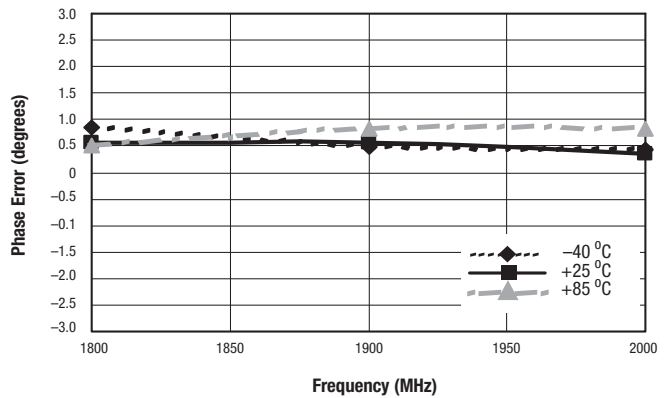

Figure 40. I/Q Phase Error vs Frequency and Temperature @ 1900 MHz

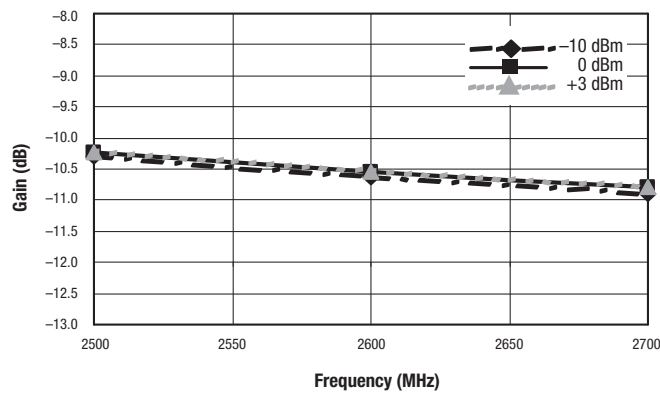

Figure 41. Power Conversion Gain vs Frequency and LO Power @ 2600 MHz

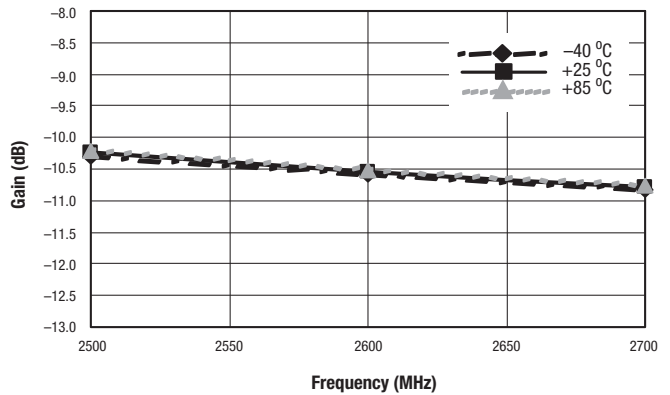

Figure 42. Power Conversion Gain vs Frequency and Temperature @ 2600 MHz

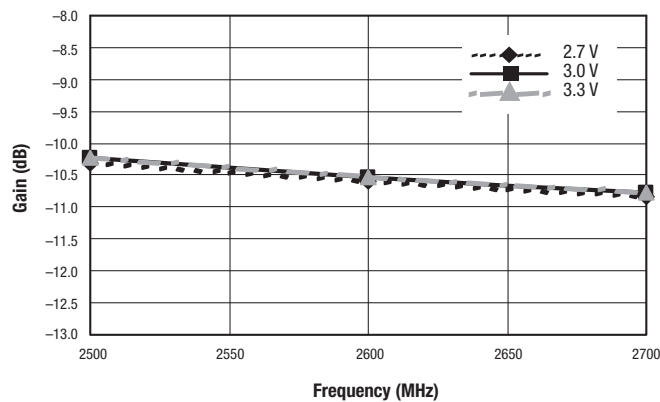

Figure 43. Power Conversion Gain vs Frequency and Supply Voltage @ 2600 MHz

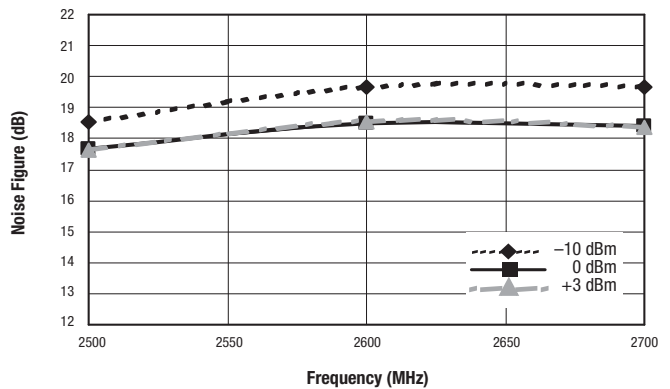

Figure 44. Noise Figure vs Frequency and LO Power @ 2600 MHz

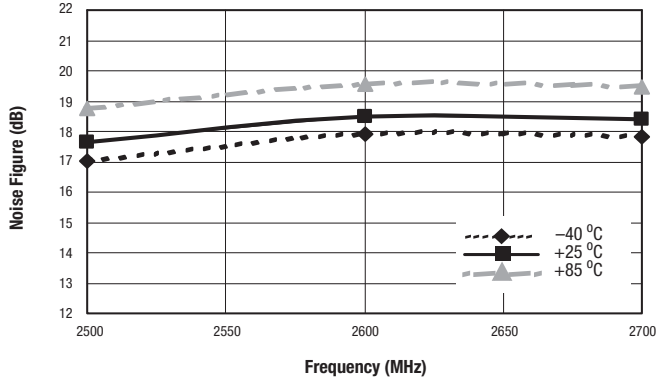

Figure 45. Noise Figure vs Frequency and Temperature @ 2600 MHz

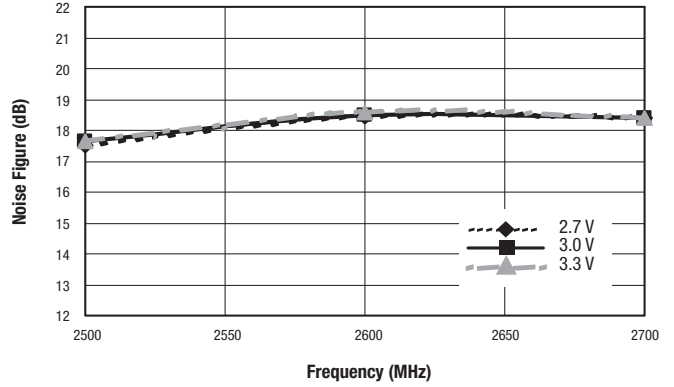

Figure 46. Noise Figure vs Frequency and Supply Voltage @ 2600 MHz

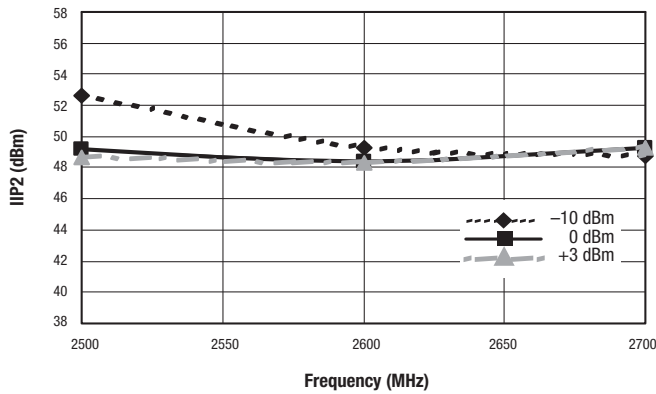

Figure 47. IIP2 vs Frequency and LO Power @ 2600 MHz

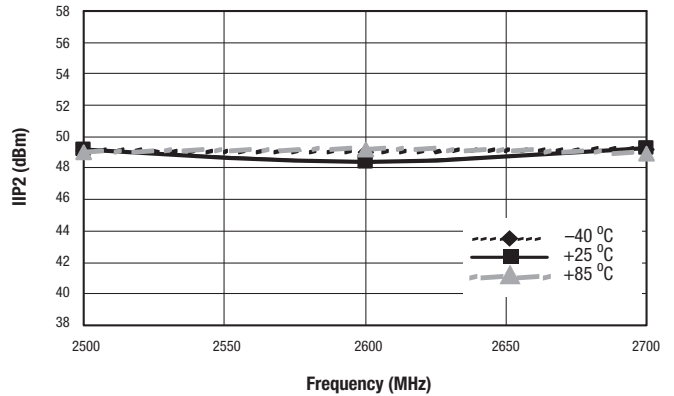

Figure 48. IIP2 vs Frequency and Temperature @ 2600 MHz

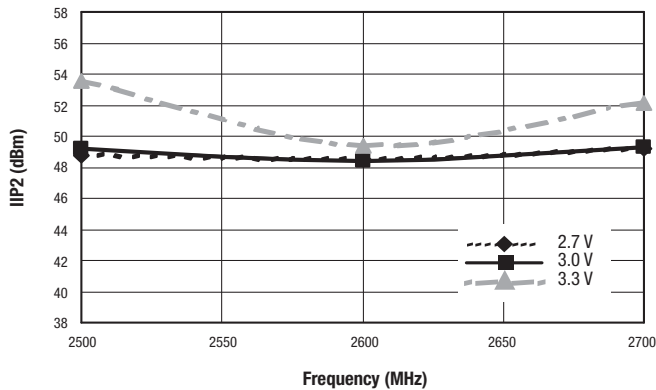

Figure 49. IIP2 vs Frequency and Supply Voltage @ 2600 MHz

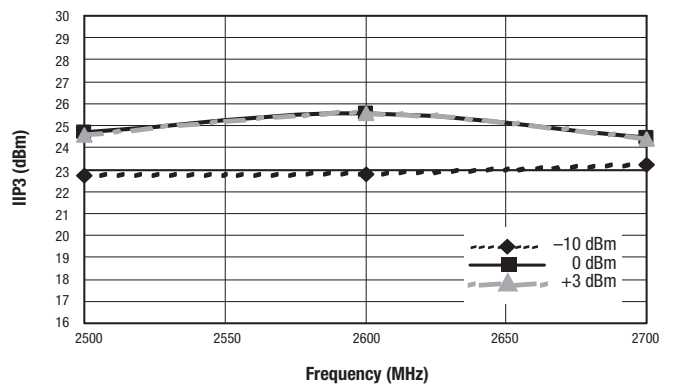

Figure 50. IIP3 vs Frequency and LO Power @ 2600 MHz

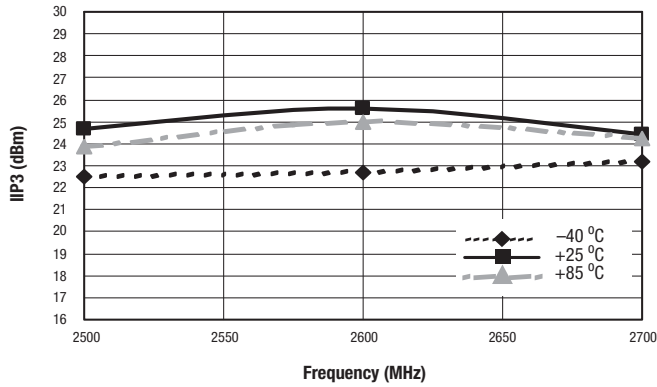

Figure 51. IIP3 vs Frequency and Temperature @ 2600 MHz

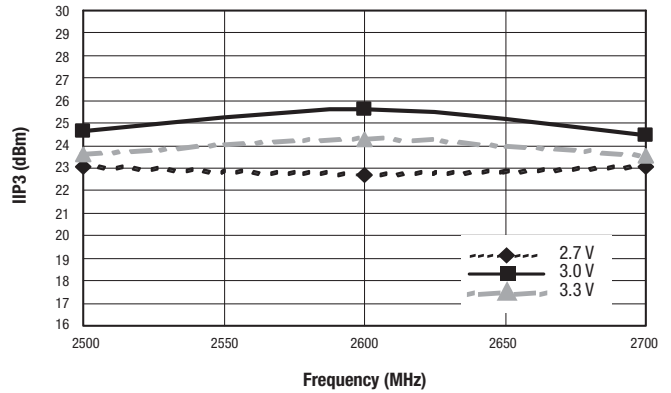

Figure 52. IIP3 vs Frequency and Supply Voltage @ 2600 MHz

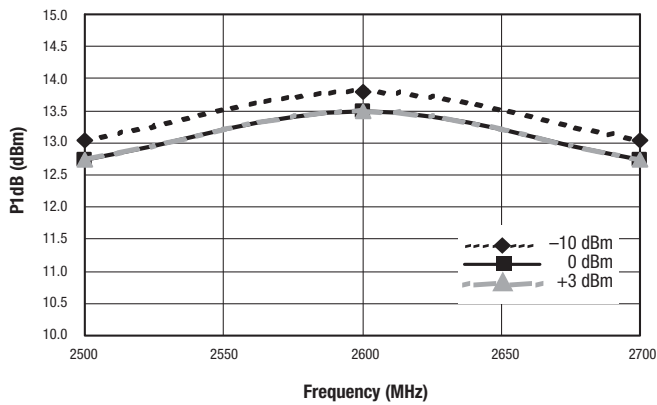

Figure 53. Input 1 dB Compression Point vs Frequency and LO Power @ 2600 MHz

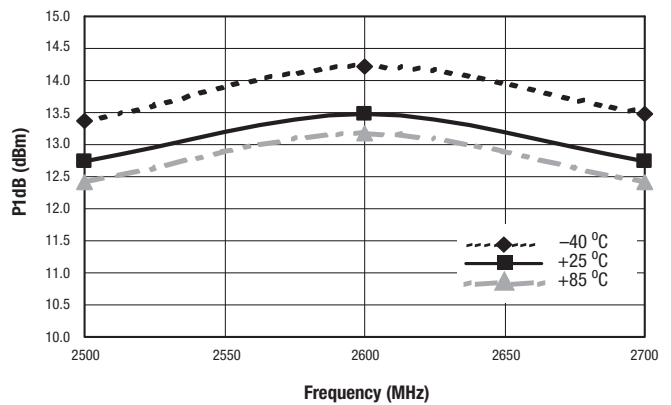

Figure 54. Input 1 dB Compression Point vs Frequency and Temperature @ 2600 MHz

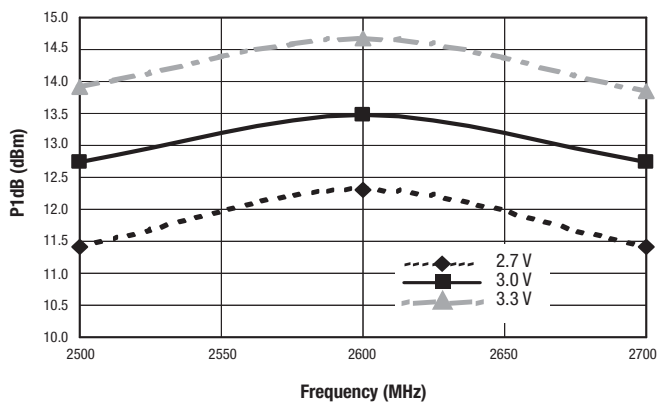

Figure 55. Input 1 dB Compression Point vs Frequency and Supply Voltage @ 2600 MHz

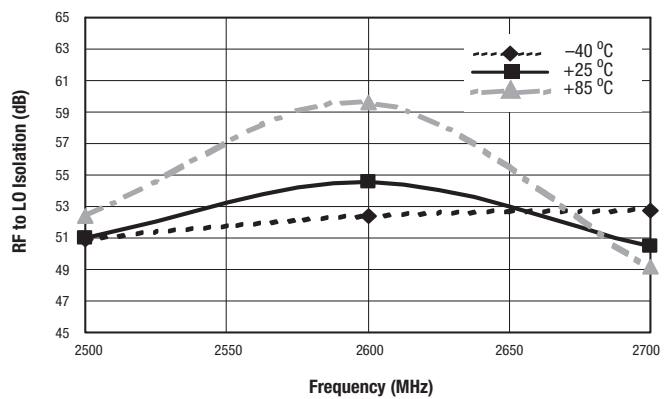

Figure 56. RF to LO Isolation vs Frequency and Temperature @ 2600 MHz

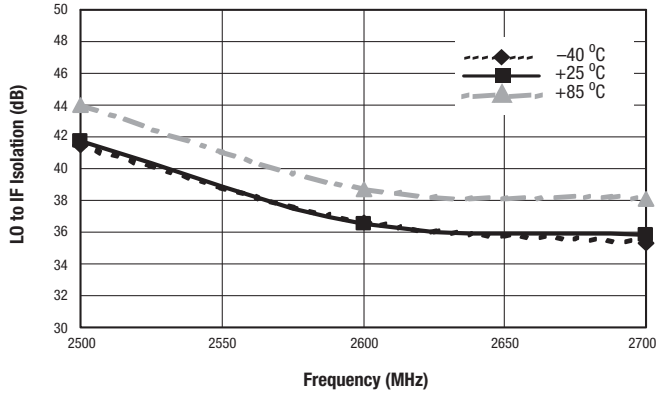

Figure 57. LO to IF Isolation vs Frequency and Temperature @ 2600 MHz

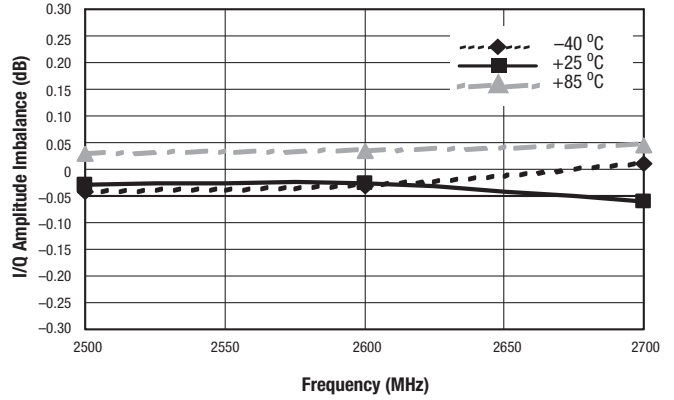

Figure 58. I/Q Amplitude Imbalance vs Frequency and Temperature @ 2600 MHz

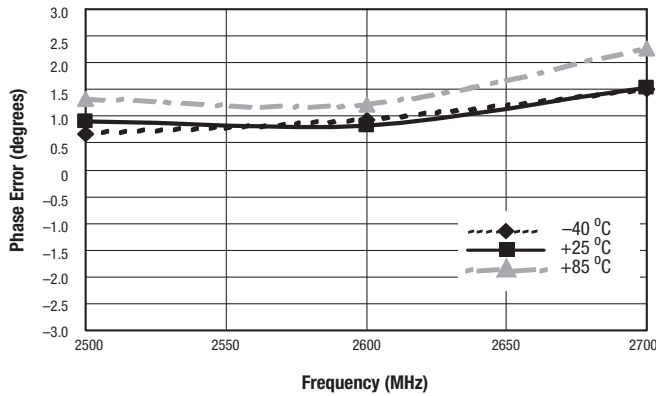

Figure 59. I/Q Phase Error vs Frequency and Temperature @ 2600 MHz

Evaluation Board Description

The SKY73012 Evaluation Board is used to test the performance of the SKY73012 direct quadrature demodulator. There are three Evaluation Boards for this device, each configured for a specific frequency range. Each of these boards is described by the following Figures and Tables:

- 800 to 1000 MHz: Figure 60 (schematic), Table 5 (component values), and Figure 61 (assembly diagram)
- 1800 to 3900 MHz: Figure 62 (schematic), Table 6 (component values), and Figure 63 (assembly diagram)
- Custom Frequency: Figure 64 (schematic), Table 7 (component values), and Figure 65 (assembly diagram)

Circuit Design Considerations

The following design considerations are general in nature and must be followed regardless of final use or configuration.

1. Paths to ground should be made as short as possible.
2. The ground pad of the SKY73012 direct quadrature demodulator has special electrical and thermal grounding requirements. This pad is the main thermal conduit for heat dissipation. Since the circuit board acts as the heat sink, it must shunt as much heat as possible from the device. As such, design the connection to the ground pad to dissipate the maximum wattage produced to the circuit board.
3. Two external output bypass capacitors are required on the VCC pin. The values of these capacitors will change with respect to the desired RF frequency. One capacitor should be used for low frequency bypassing and the other capacitor for high frequency bypassing. Special attention should be given so that the smaller value capacitor does not go into self-resonance at the desired RF frequency.
4. The RF input must be driven differentially. A 1:1 impedance ratio balun is recommended with a center tap on the secondary side that is DC grounded.

Testing Procedure

Use the following procedure to set up the SKY73012 Evaluation Board for testing. Refer to Figure 66 for guidance:

1. Connect a +3.0 VDC power supply using an insulated supply cable. If available, enable the current limiting function of the power supply to 100 mA.
2. Connect a signal generator to the RF signal input port. Set it to the desired RF frequency at a power level of 0 dBm to the Evaluation Board but do NOT enable the RF signal.
3. Connect a signal generator to the LO signal input port. Set to the desired LO frequency at a power level of 0 dBm, but do not enable.
4. Connect a spectrum analyzer to the IFI signal output port and terminate the IFQ signal input port in 50 Ω .
5. Enable the power supply.
6. Enable the LO input signal.
7. Enable the RF signal.
8. Take measurements and repeat these steps for channel Q.

CAUTION: *If any of the input signals exceed the rated maximum values, the SKY73012 Evaluation Board can be permanently damaged.*

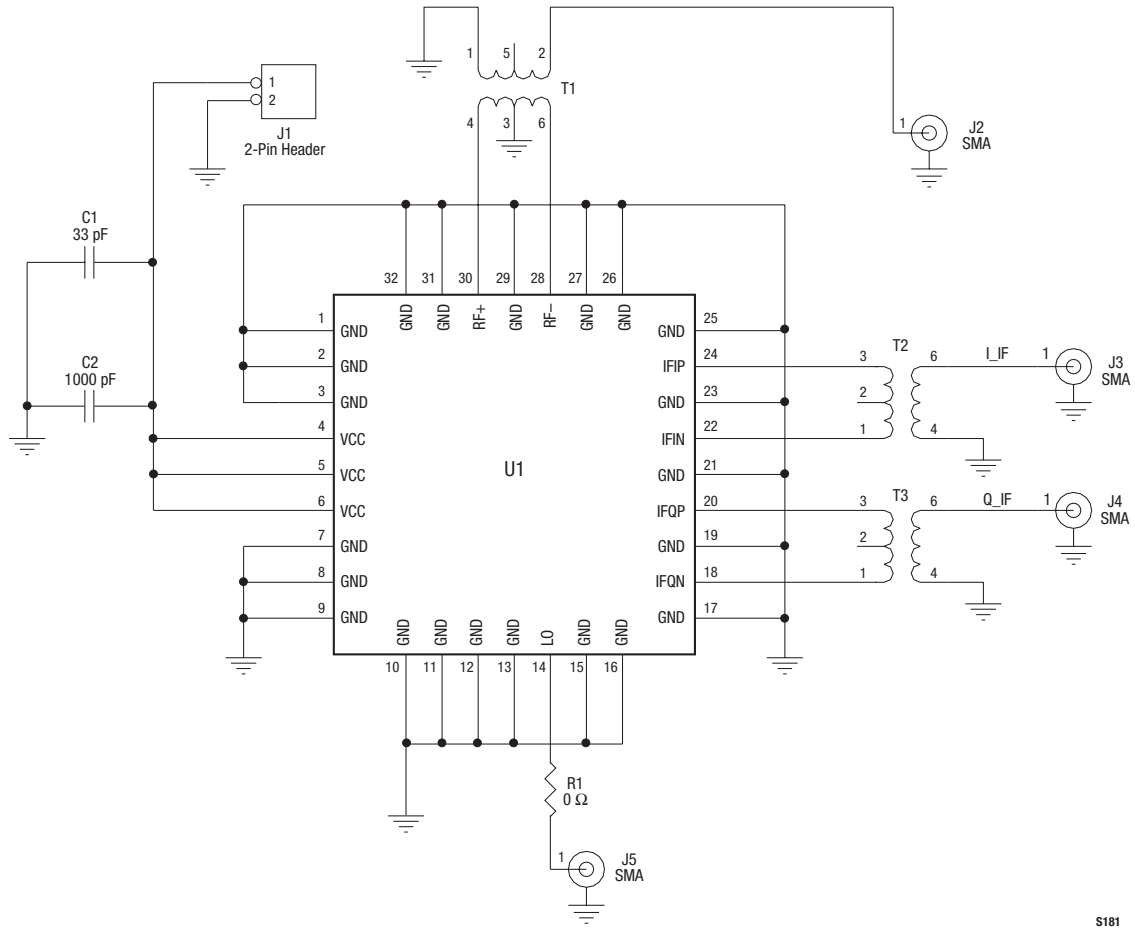

S181

Figure 60. SKY73012 Evaluation Board Schematic (800 to 1000 MHz)

Table 5. SKY73012 Evaluation Board Component Values (800 to 1000 MHz)

Reference Designator	Quantity	Value	Manufacturer	Part Number
C1	1	33 pF (0603)		
C2	1	1000 pF (0603)		
J1	1	Two-pin header connector		
J2	1	SMA connector		
J3	1	SMA connector		
J4	1	SMA connector		
J5	1	SMA connector		
R1	1	0 Ω (0603)		
T1	1	1:1 (800-1000 MHz)	Murata	LDB31900M05C-417
T2	1	9:1	Mini-Circuits	TCM-9-1
T3	1	9:1	Mini-Circuits	TCM-9-1
U1	1	–	Skyworks	SKY73012-11

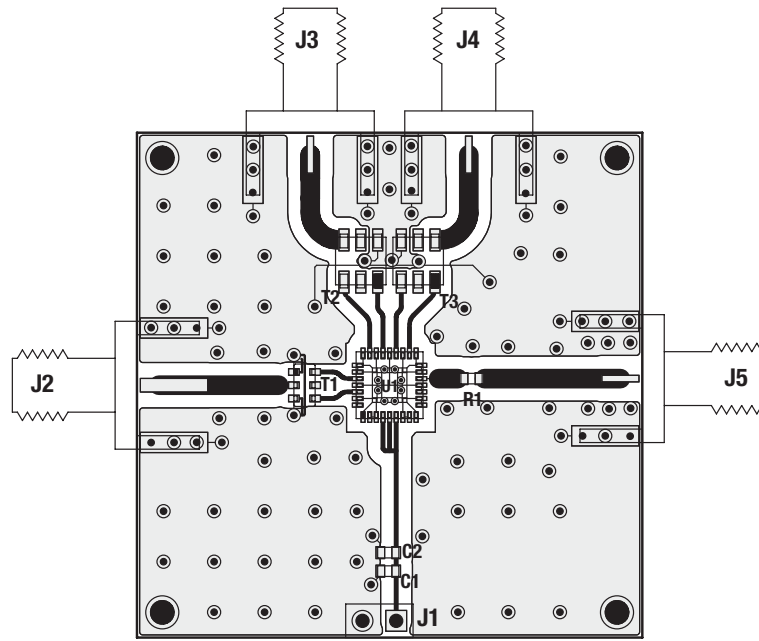

Component Placement

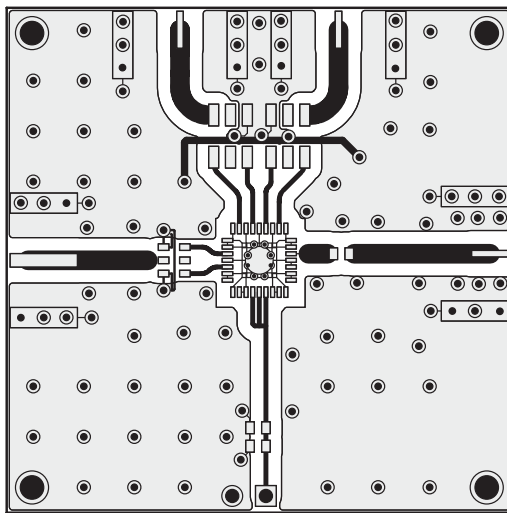

Top Layer

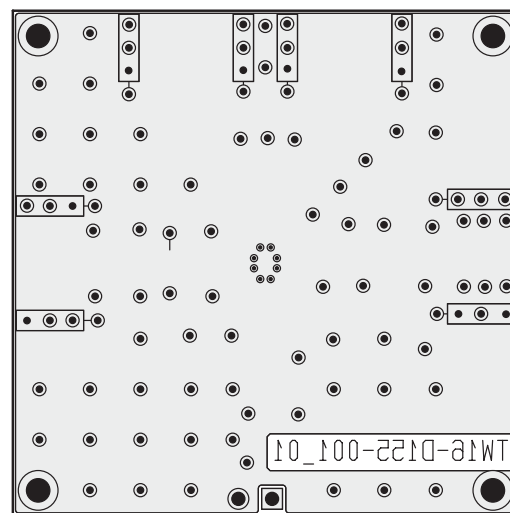

Bottom Layer

S920

**Figure 61. SKY73012 Evaluation Board Assembly Diagram (800 to 1000 MHz)
(Top View)**

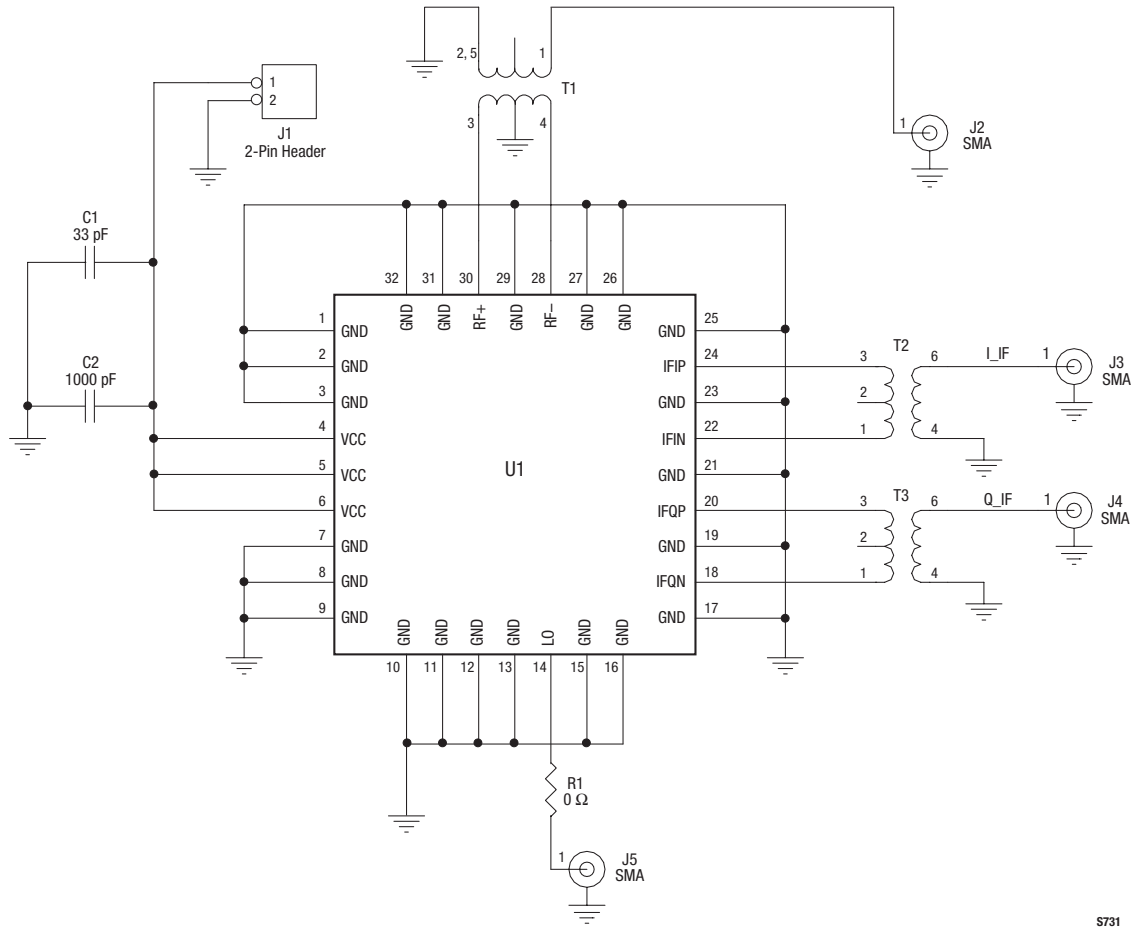

S731

Figure 62. SKY73012 Evaluation Board Schematic (1800 to 3900 MHz)

Table 6. SKY73012 Evaluation Board Component Values (1800 to 3900 MHz)

Reference Designator	Quantity	Value	Manufacturer	Part Number
C1	1	33 pF (0603)		
C2	1	1000 pF (0603)		
J1	1	Two-pin header connector		
J2	1	SMA connector		
J3	1	SMA connector		
J4	1	SMA connector		
J5	1	SMA connector		
R1	1	0 Ω (0603)		
T1	1	1:1 (1800-2000 MHz), or 1:1 (2500-2700 MHz), or 1:1 (3600-3800 MHz)	Murata Murata Johanson	LDB211G9005C-001 LDB212G4005C-001 3700BL15B050SX
T2	1	9:1	Mini-Circuits	TCM-9-1
T3	1	9:1	Mini-Circuits	TCM-9-1
U1	1	–	Skyworks	SKY73012-11

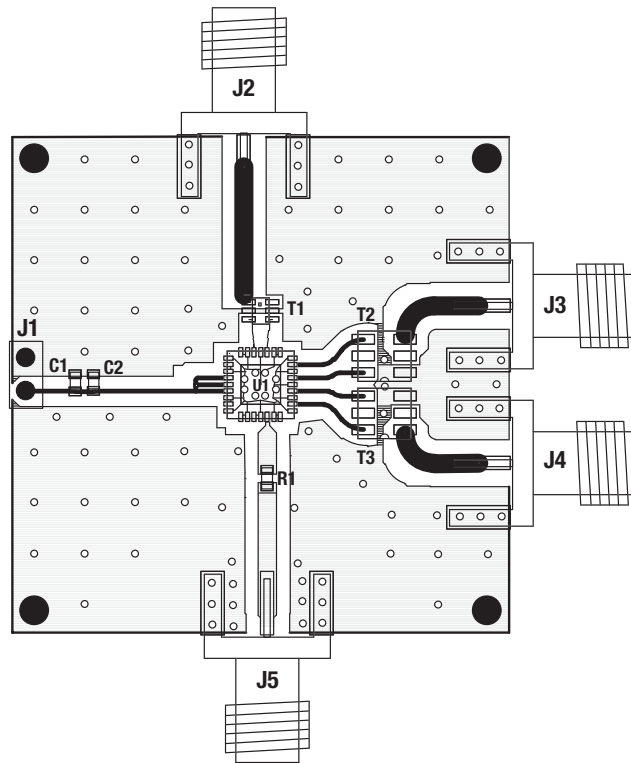

Component Placement

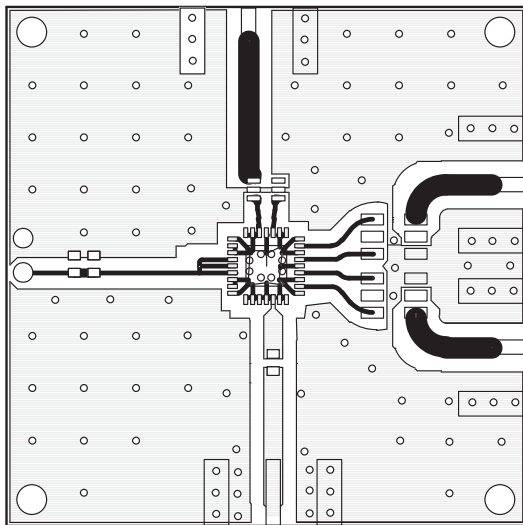

Top Layer

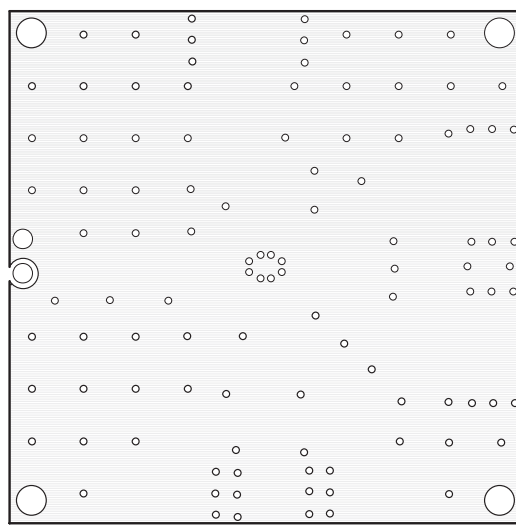

Bottom Layer

S921

**Figure 63. SKY73012 Evaluation Board Assembly Diagram (1800 to 3900 MHz)
(Top View)**

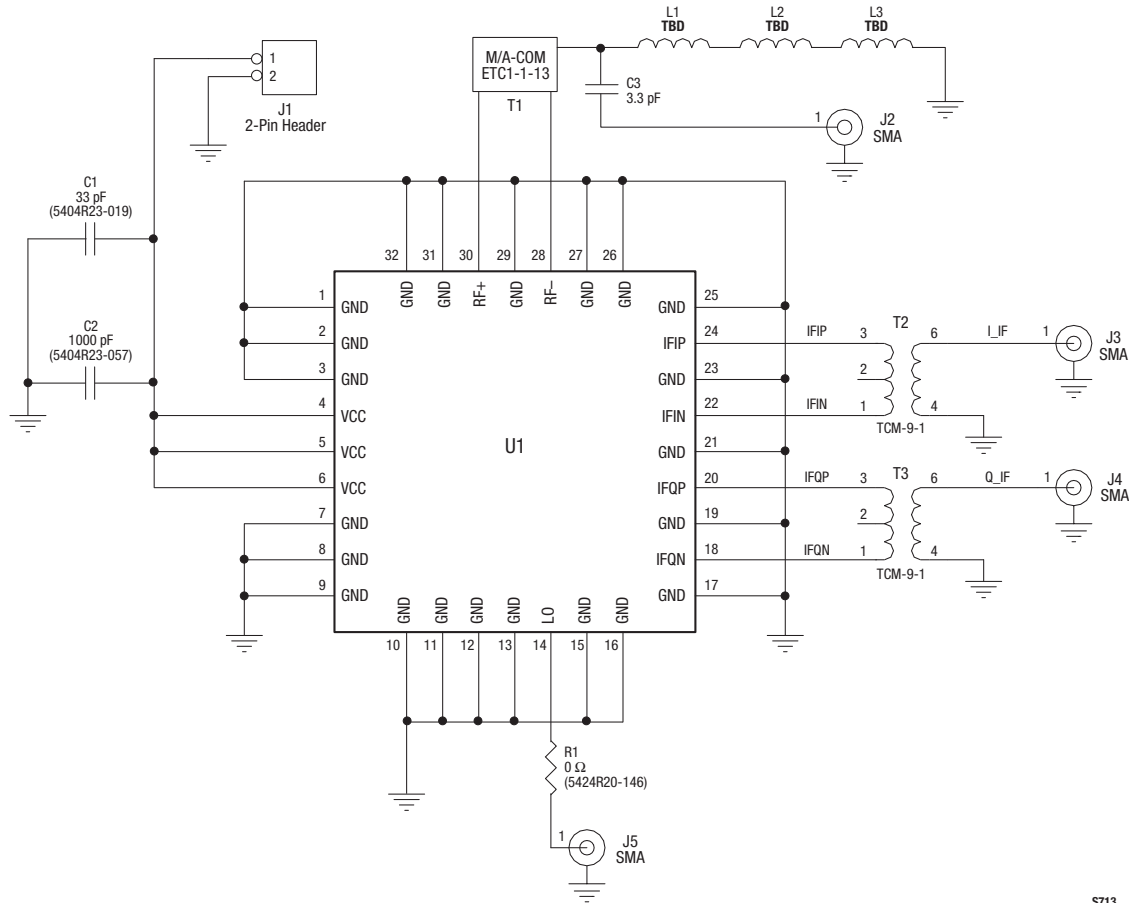

S713

Figure 64. SKY73012 Evaluation Board Schematic (Custom Frequency)

Table 7. SKY73012 Evaluation Board Component Values (Custom Frequency) (1 of 2)

Reference Designator	Quantity	Value	Manufacturer	Part Number
C1	1	33 pF (0603)		
C2	1	1000 pF (0603)		
C3		Adjusted for best match at desired frequency		
J1	1	Two-pin header connector		
J2	1	SMA connector		
J3	1	SMA connector		
J4	1	SMA connector		
J5	1	SMA connector		
L1	1	Adjusted for best match at desired frequency		
L2	1	Adjusted for best match at desired frequency		
L3	1	Adjusted for best match at desired frequency		

Table 7. SKY73012 Evaluation Board Component Values (Custom Frequency) (2 of 2)

Reference Designator	Quantity	Value	Manufacturer	Part Number
R1	1	0 Ω (0603)		
T1	1	1:1 (4.5-3000 MHz),	M/A-COM	ETC1-1-13
T2	1	9:1	Mini-Circuits	TCM-9-1
T3	1	9:1	Mini-Circuits	TCM-9-1
U1	1	–	Skyworks	SKY73012-11

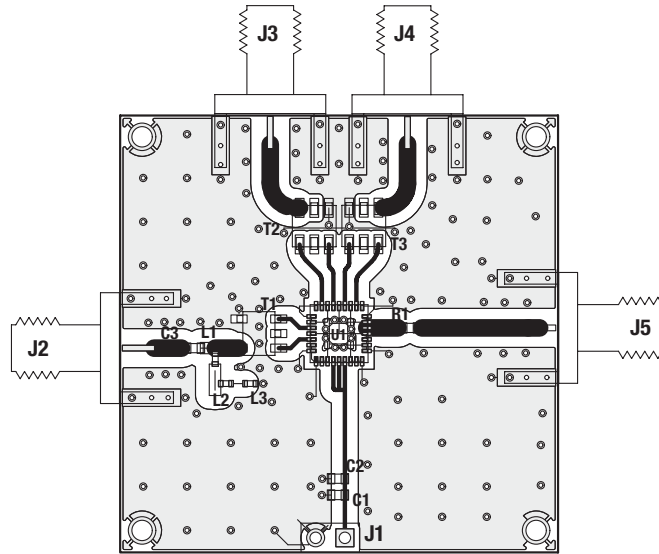

Component Placement

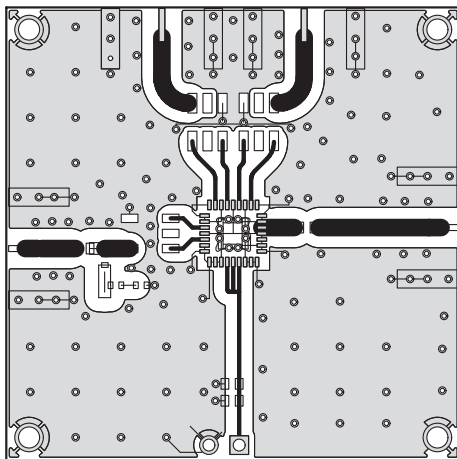

Top Layer

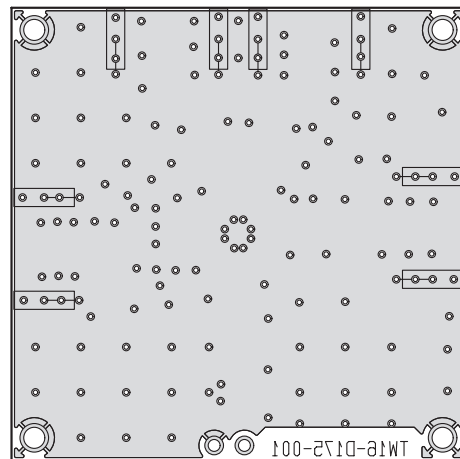

Bottom Layer

S922

Figure 65. SKY73012 Evaluation Board Assembly Diagram (Custom Frequency) (Top View)

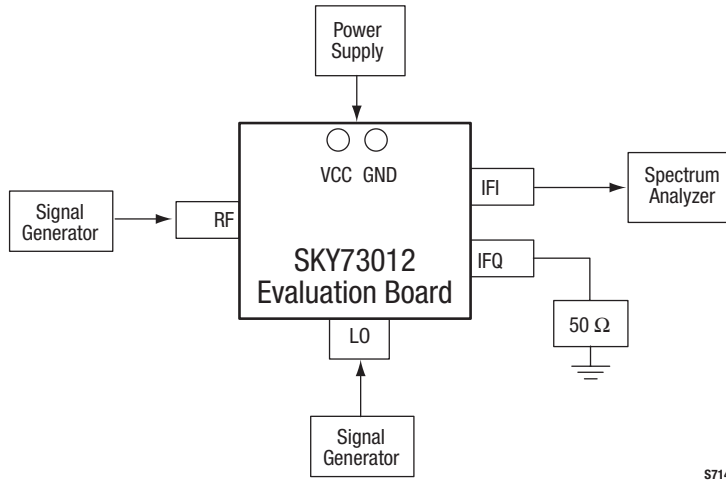

S714

Figure 66. SKY73012 Evaluation Board Testing Configuration

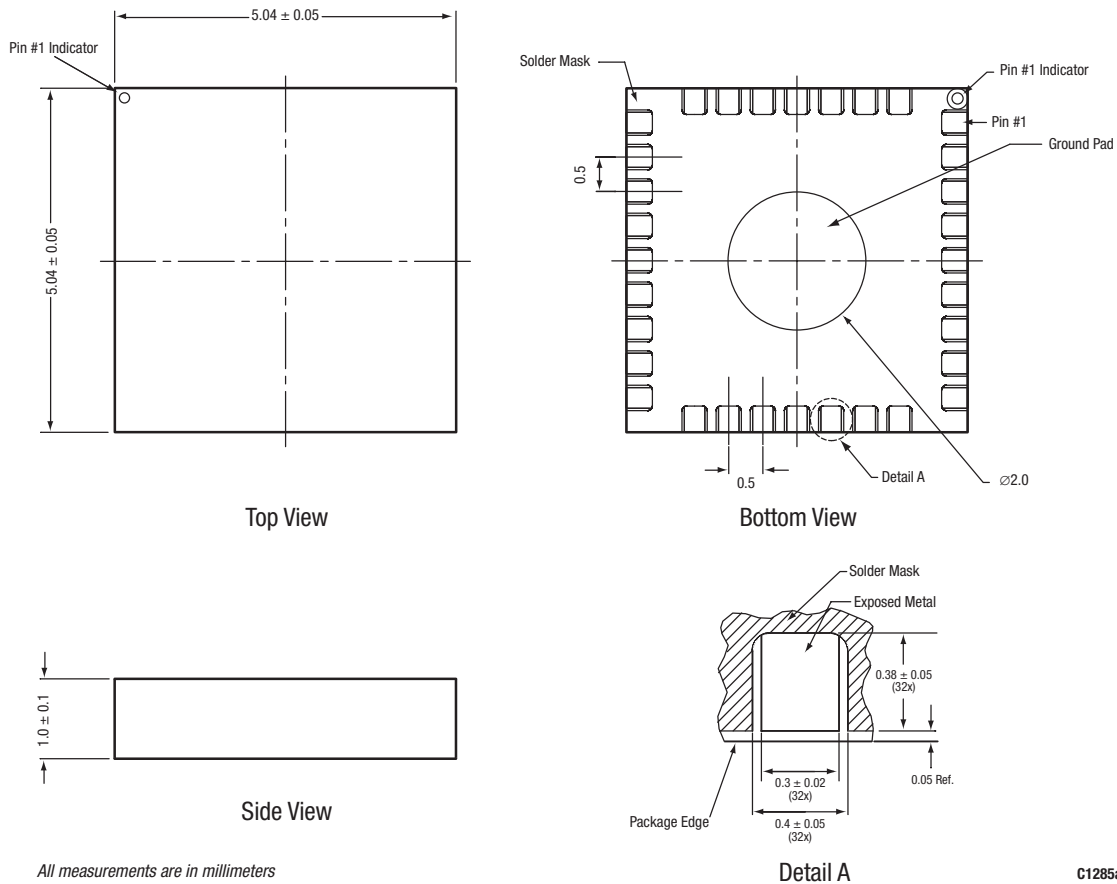

All measurements are in millimeters

C1285a

Figure 67. SKY73012 32-Pin RFLGA Package Dimensions

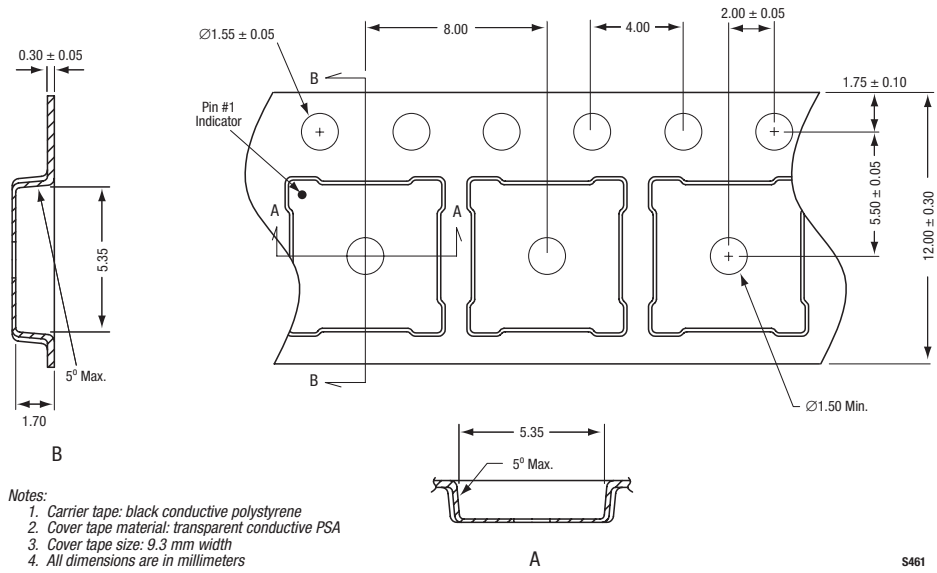

Figure 68. SKY73012 32-Pin RFLGA Tape and Reel Dimensions

Ordering Information

Model Name	Manufacturing Part Number	Evaluation Kit Part Number
SKY73012 400-3900 MHz Direct Quadrature Modulator	SKY73012-11 (Pb-free package)	TW16-D151-001 (800 to 1000 MHz) TW16-D166-001 (1800 to 2000 MHz) TW16-D167-001 (2400 to 2700 MHz) TW16-D168-001 (3200 to 3900 MHz) TW16-D171-001 (Custom Frequency)

Copyright © 2006, 2007 Skyworks Solutions, Inc. All Rights Reserved.

Information in this document is provided in connection with Skyworks Solutions, Inc. ("Skyworks") products or services. These materials, including the information contained herein, are provided by Skyworks as a service to its customers and may be used for informational purposes only by the customer. Skyworks assumes no responsibility for errors or omissions in these materials or the information contained herein. Skyworks may change its documentation, products, services, specifications or product descriptions at any time, without notice. Skyworks makes no commitment to update the materials or information and shall have no responsibility whatsoever for conflicts, incompatibilities, or other difficulties arising from any future changes.

No license, whether express, implied, by estoppel or otherwise, is granted to any intellectual property rights by this document. Skyworks assumes no liability for any materials, products or information provided hereunder, including the sale, distribution, reproduction or use of Skyworks products, information or materials, except as may be provided in Skyworks Terms and Conditions of Sale.

THE MATERIALS, PRODUCTS AND INFORMATION ARE PROVIDED "AS IS" WITHOUT WARRANTY OF ANY KIND, WHETHER EXPRESS, IMPLIED, STATUTORY, OR OTHERWISE, INCLUDING FITNESS FOR A PARTICULAR PURPOSE OR USE, MERCHANTABILITY, PERFORMANCE, QUALITY OR NON-INFRINGEMENT OF ANY INTELLECTUAL PROPERTY RIGHT; ALL SUCH WARRANTIES ARE HEREBY EXPRESSLY DISCLAIMED. SKYWORKS DOES NOT WARRANT THE ACCURACY OR COMPLETENESS OF THE INFORMATION, TEXT, GRAPHICS OR OTHER ITEMS CONTAINED WITHIN THESE MATERIALS. SKYWORKS SHALL NOT BE LIABLE FOR ANY DAMAGES, INCLUDING BUT NOT LIMITED TO ANY SPECIAL, INDIRECT, INCIDENTAL, STATUTORY, OR CONSEQUENTIAL DAMAGES, INCLUDING WITHOUT LIMITATION, LOST REVENUES OR LOST PROFITS THAT MAY RESULT FROM THE USE OF THE MATERIALS OR INFORMATION, WHETHER OR NOT THE RECIPIENT OF MATERIALS HAS BEEN ADVISED OF THE POSSIBILITY OF SUCH DAMAGE.

Skyworks products are not intended for use in medical, lifesaving or life-sustaining applications, or other equipment in which the failure of the Skyworks products could lead to personal injury, death, physical or environmental damage. Skyworks customers using or selling Skyworks products for use in such applications do so at their own risk and agree to fully indemnify Skyworks for any damages resulting from such improper use or sale.

Customers are responsible for their products and applications using Skyworks products, which may deviate from published specifications as a result of design defects, errors, or operation of products outside of published parameters or design specifications. Customers should include design and operating safeguards to minimize these and other risks. Skyworks assumes no liability for applications assistance, customer product design, or damage to any equipment resulting from the use of Skyworks products outside of stated published specifications or parameters.

Skyworks, the Skyworks symbol, and "Breakthrough Simplicity" are trademarks or registered trademarks of Skyworks Solutions, Inc., in the United States and other countries. Third-party brands and names are for identification purposes only, and are the property of their respective owners. Additional information, including relevant terms and conditions, posted at www.skyworksinc.com, are incorporated by reference.