

Preliminary



SF2062A

**229.25 MHz
SAW Filter**

- Quartz Temperature Stability
- Small Size
- Hermetic 11.5x4.0mm Surface-Mount Case
- Complies with Directive 2002/95/EC (RoHS)



Absolute Maximum Ratings

Rating	Value	Units
Maximum Incident Power in Passband	+10	dBm
Max. DC voltage between any 2 terminals	30	VDC
Storage Temperature Range	-40 to +85	°C
Suitable for lead-free soldering - Max. Soldering Profile	260°C for 30 s	

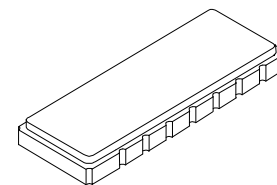

SM1154-14

Electrical Characteristics

Characteristic	Sym	Notes	Min	Typ	Max	Units
Nominal Center Frequency	f_c	1		229.25		MHz
Passband	Insertion Loss at f_c	IL			8.35	dB
	3 dB Passband	BW_3	± 150			kHz
	$F_c \pm 100$ kHz Ripple			0.9		dB
	I/O Impedance			50		Ohm
	Group Delay Deviation across $F_c \pm 100$ kHz (-20 to +60°C)	GDD			150	
Attenuation	$f_c \pm 600$ kHz		20			dB
	$f_c \pm 900$ kHz		34			
	$f_c \pm 1.2$ MHz		32			
	10 MHz to 2 GHz		20			
Operating Temperature Range	T_A	1	-20		+80	°C

Matching to Unbalanced 50 Ω	External L-C	
Case Style	6	SM1154-14 11.5 x 4.0 mm Nominal Footprint
Lid Symbolization (YY=year, WW=week S=shift, ##=sequence code)		RFM SF2062A YYWWS##

Notes:

1. Unless noted otherwise, all specifications apply over the operating temperature range with filter soldered to the specified demonstration board with impedance matching to 50 Ω and measured with 50 Ω network analyzer.
2. Unless noted otherwise, all frequency specifications are referenced to the nominal center frequency, f_c .
3. Rejection is measured as attenuation below the minimum IL point in the passband. Rejection in final user application is dependent on PCB layout and external impedance matching design. See Application Note No. 42 for details.
4. The design, manufacturing process, and specifications of this filter are subject to change.
5. US and international patents may apply.
6. RFM, stylized RFM logo, and RF Monolithics, Inc. are registered trademarks of RF Monolithics, Inc.
7. ©Copyright 1999, RF Monolithics Inc.
8. Electrostatic Sensitive Device. Observe precautions for handling. 

15 Jun 2006 16:26:04

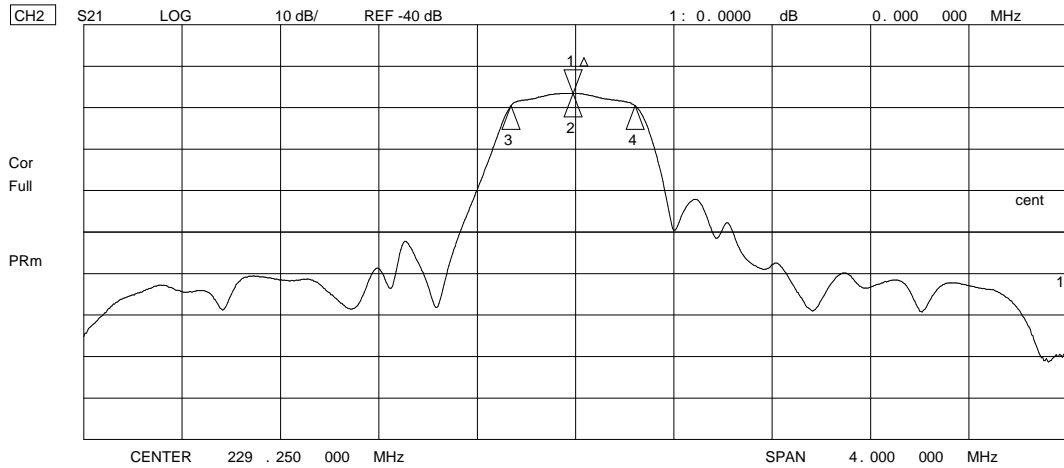
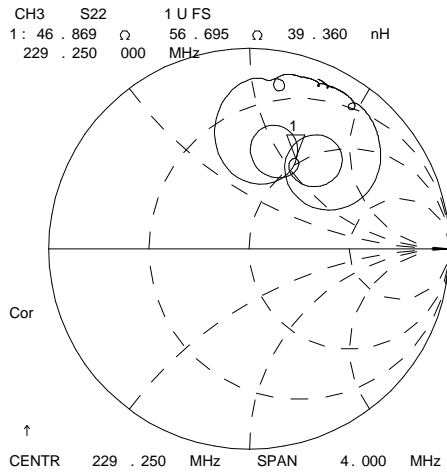
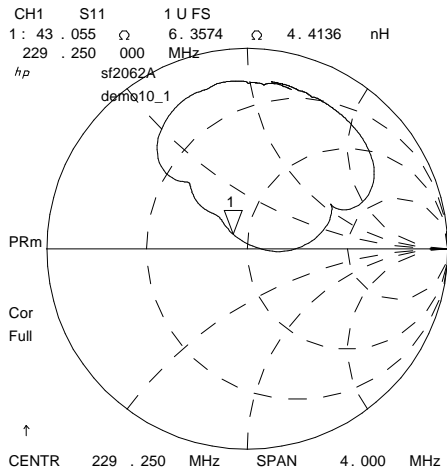

CH2 Markers
 Max Δ REF=1
 BW: .504463 MHz
 cent: 229.239695 MHz
 Q: 454.42
 1 loss: -6.5451 dB

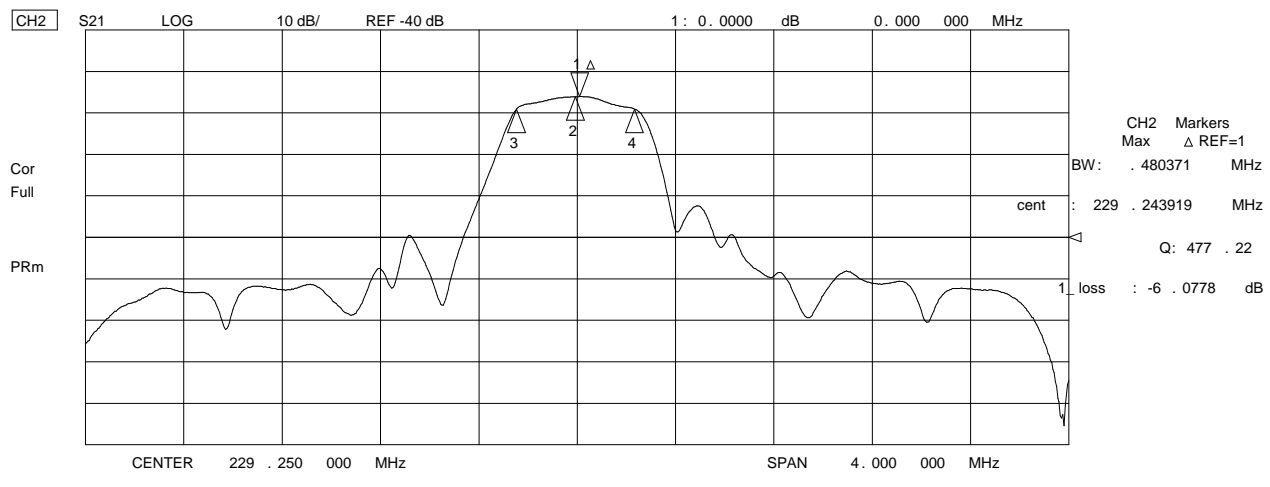
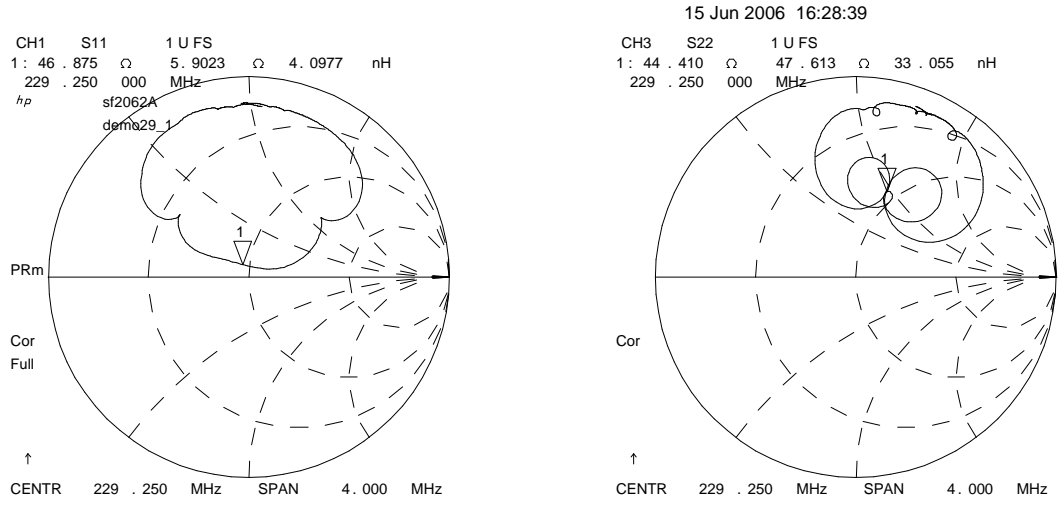

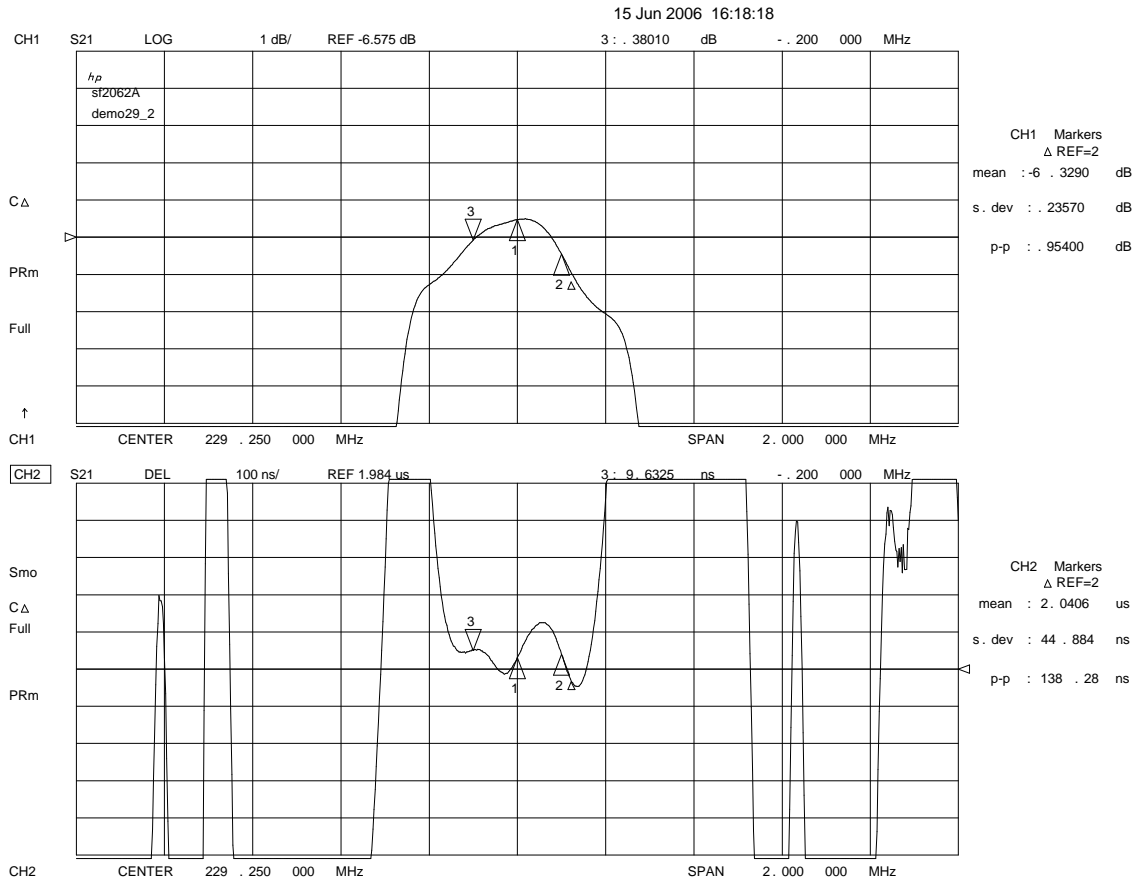

SF2062A Demo Board Rev 2

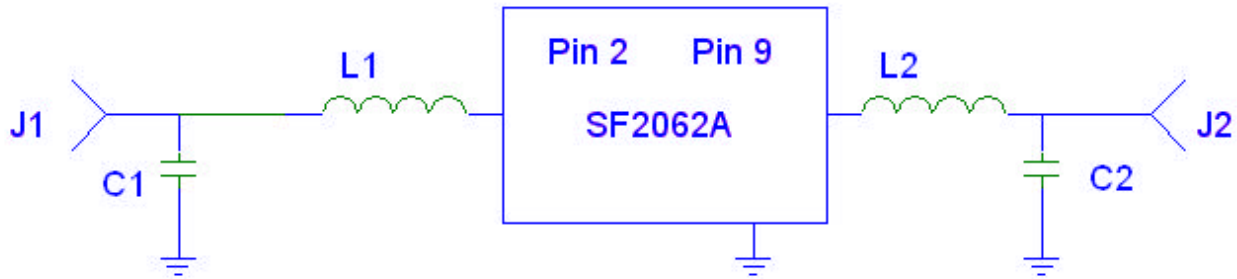

All other pins ground

PCB=400-1650-001 PCB

J1, J2=500-0248-002 2 hole flange SMA

C1=15 pF 500-0003-150 C2=10 pF 500-0003-100

L1=68 nH 0805CS

L2=82 nH 0805CS

Shield=Brass shim stock

SM1154-14 Case

14-Terminal Ceramic Surface-Mount Case
11.5 x 4.0 mm Nominal Footprint

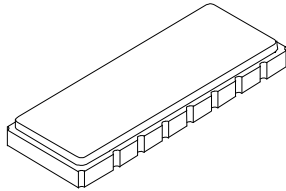

Dimension	Case Dimensions					
	mm			Inches		
	Min	Nom	Max	Min	Nom	Max
A	11.4	11.5	11.6	.442	0.450	0.458
B	3.8	4.0	4.2	.150	0.157	.166
C	1.4	1.6	1.8	.057	0.063	.069
D	1.3	1.5	1.7	.053	0.059	.065
E		0.76			0.030	
F		1.27			0.050	
G		1.27			0.050	
H		0.1			0.004	

Materials	
Solder Pad Termination	Au plating 30 - 60 μinches (76.2-152 μm) over 80-200 μinches (203-508 μm) Ni.
Lid	Fe-Ni-Co Alloy Electroless Nickel Plate (8-11% Phosphorus) 100-200 μinches Thick
Body	Al ₂ O ₃ Ceramic
Pb Free	

Electrical Connections	
Connection	Terminals
Input	2
Output	9
Ground	All Others

Recommended PCB Footprint

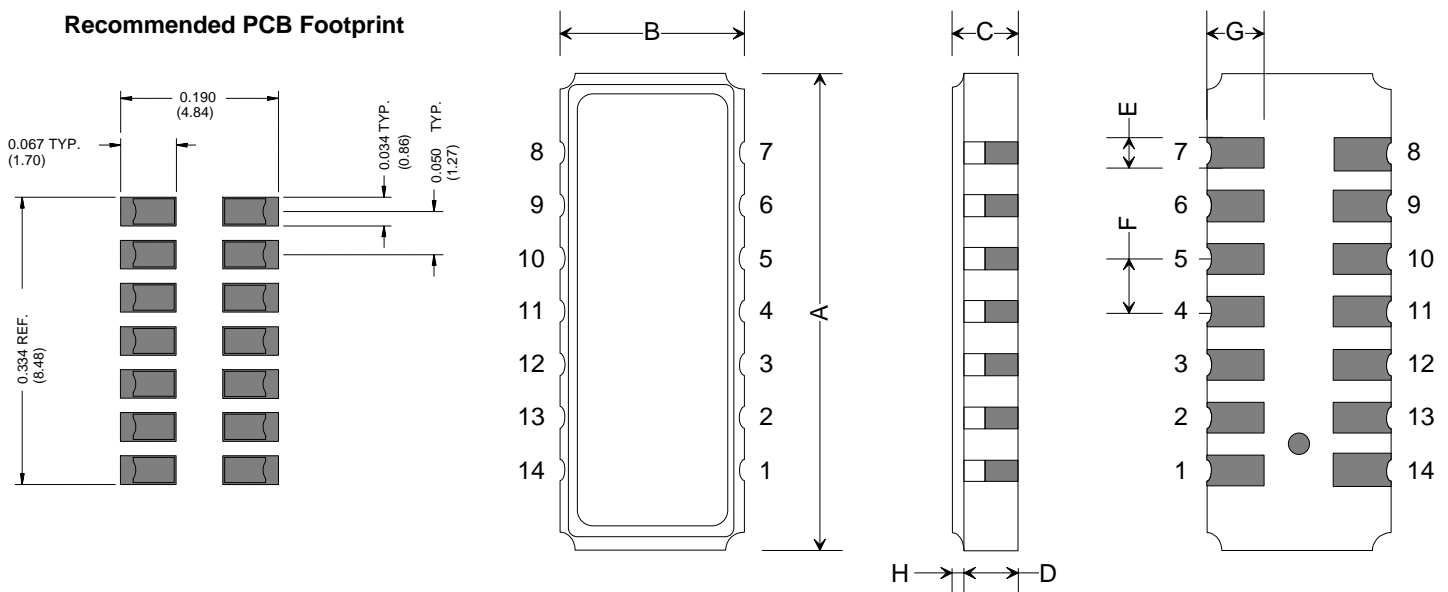

COMPONENT ORIENTATION and DIMENSIONS

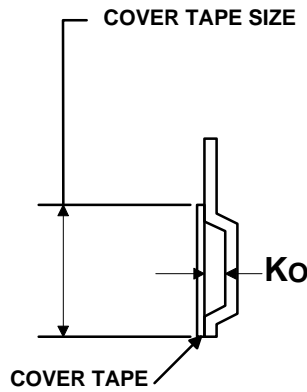
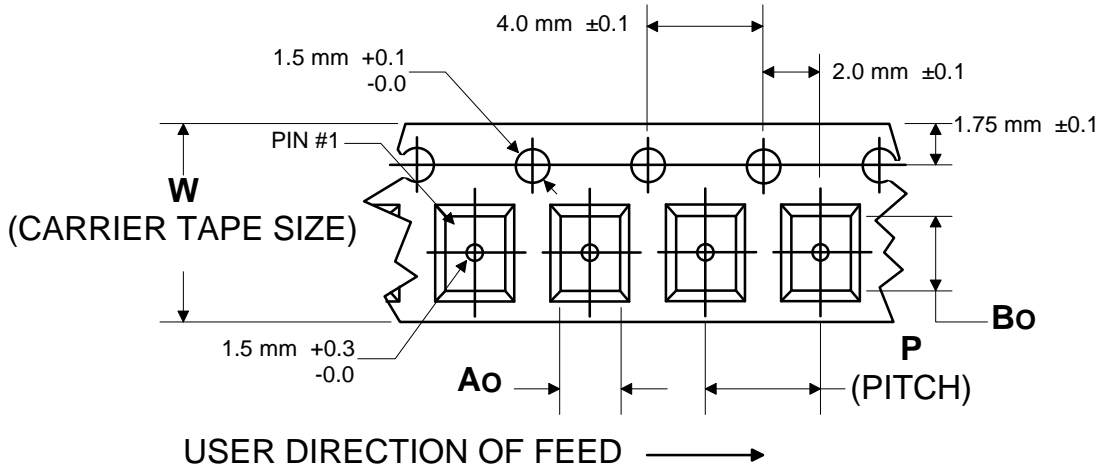

Carrier Tape Dimensions		
Ao	4.55 mm	±0.1
Bo	12.04 mm	±0.1
Ko	2.13 mm	±0.1
Pitch	8.00 mm	±0.1
W	24.00 mm	±0.3

Additional items

(1) Cover tape peeling strength

The cover tape shall be adhered evenly to the carrier tape along both sides in the pulling direction.

The cover tape peeling strength shall be as follows for an angle between the cover tape and the pulling direction of 165° to 180° (see the figure) and a peeling speed of 300mm/min. ±10mm/min.

[EIA-481] 0.1N to 1.3N for a tape width of 12 to 56mm

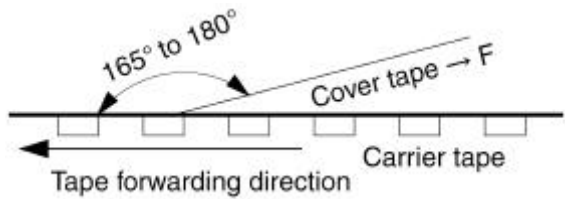

Fixing method

1. Insert the tip of the carrier tape into the groove.
2. Fix the tip of the cover tape with adhesive tape.

Tape material

(1) Carrier tape [anti-charging treatment: carbon used] Surface resistivity: 1×10^8 or less
Material: Polystyrene or Polycarbonate

(2) Cover tape material: Polyester (anti-charging treated) Surface resistivity: 1×10^{12} or less
 $t = 50$ to $100\mu\text{m}$

Warranty periods

Cover tape peeling strength and mounting performance of stored components.

2-1. Cover tape peeling strength: One year after delivery (Peeling strength: 0.1N to 1.3N)

Number of missing components

There shall not be two or more consecutive missing components. Also, the maximum number of missing components shall be the larger of one piece or 0.1%.

Storage environment

Keep the product on which taping has been performed to a temperature below 40°C and a humidity within 80% RH. Do not subject in the direct sun.

Package for Shipment

	Quantity Per Reel	Number Reels Per Carton	External Carton Dimensions	Reel Weight	Shipping Carton Weight	Total Weight
7 Inch Reel	500	4	254 x 254 x 127 mm 10 x 10 x 5 inches	896 g	448 g	1344 g
	500	10	254 x 254 x 203 mm 10 x 10 x 8 inches	2240 g	448 g	2688 g
	Quantity Per Reel	Number Reels Per Carton	External Carton Dimensions	Reel Weight	Shipping Carton Weight	Total Weight
13 Inch Reel	2000	2	356 x 356 x 102 mm 14 x 14 x 4 inches	1288 g	448 g	1736 g
	2000	4	356 x 356 x 178 mm 14 x 14 x 7 inches	2576 g	448 g	3024 g
	2000	8	356 x 356 x 356 mm 14 x 14 x 14 inches	5152 g	448 g	5600 g

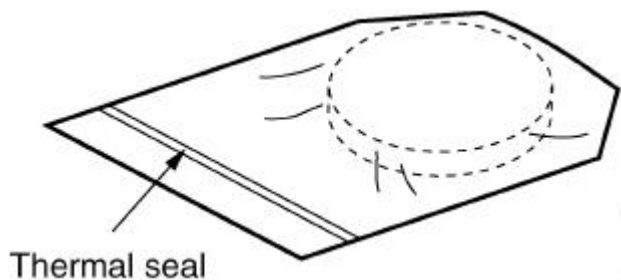
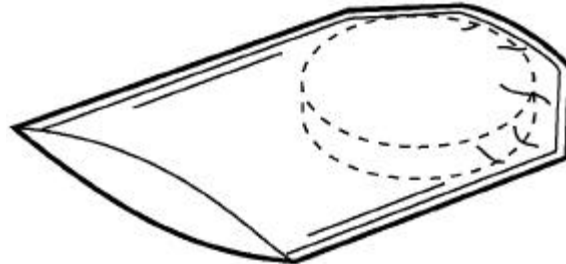

Thermal seal

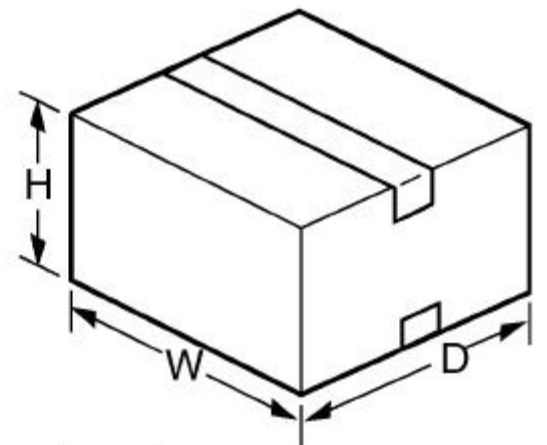

Shipment package

Sealing tape