

**RECTIFIERS**  
 High Efficiency, 2A

UES1104  
 UES1105  
 UES1106

**FEATURES**

- Very Low Forward Voltage (1.15V)
- Very Fast Recovery Times (50nSec)
- Small Size
- Convenient Package

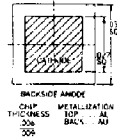

**DESCRIPTION**

The UES1104 series is specifically designed for operation in power switching circuits operating at frequencies of at least 20 KHz.

**ABSOLUTE MAXIMUM RATINGS**

Peak Inverse Voltage, UES1104	200V
Peak Inverse Voltage, UES1105	300V
Peak Inverse Voltage, UES1106	400V
Maximum Average DC Output Current, $I_O$	
@ $T_A = 25^\circ\text{C}$ (Free Air)	1A
@ $T_L = 50^\circ\text{C}$ , $L = 3/4"$	2A
Surge Current, 8.3mSec	20A
Thermal Resistance @ $L = 3/4"$	38°C/W
Operating and Storage Temperature Range	-55°C to +150°C

**MECHANICAL SPECIFICATIONS**

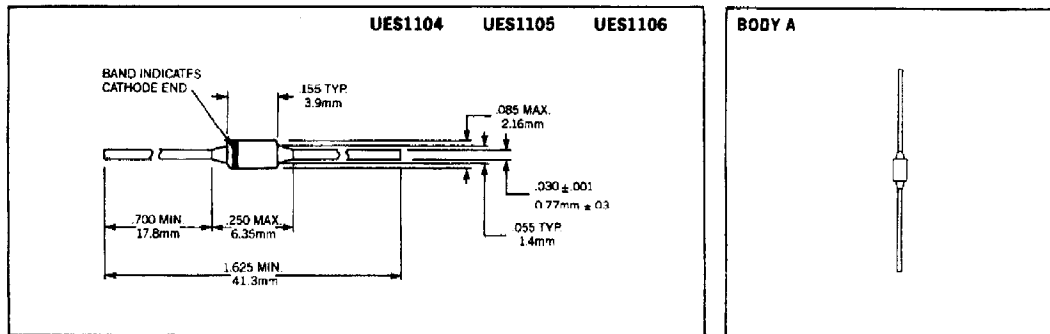

NJ Semi-Conductors reserves the right to change test conditions, parameter limits and package dimensions without notice. Information furnished by NJ Semi-Conductors is believed to be both accurate and reliable at the time of going to press. However, NJ Semi-Conductors assumes no responsibility for any errors or omissions discovered in its use. NJ Semi-Conductors encourages customers to verify that datasheets are current before placing orders.

**Quality Semi-Conductors**

**ELECTRICAL SPECIFICATIONS**

Type	PIV	Maximum Forward Voltage		Maximum Reverse Current		Maximum Reverse Recovery Time*
		T <sub>J</sub> = 25°C	T <sub>J</sub> = 100°C	@ PIV, T <sub>J</sub> = 25°C	T <sub>J</sub> = 100°C	
UES1104/1104HR	200V	1.25V	1.15V	10μA	200μA	50nS
UES1105/1105HR	300V	@ 1A	@ 1A			
UES1106/1106HR	400V	tp = 300μS	tp = 300μS			

\* Measured in circuit I<sub>F</sub> = 0.5A, I<sub>R</sub> = 1A, I<sub>RRM</sub> = 0.25A

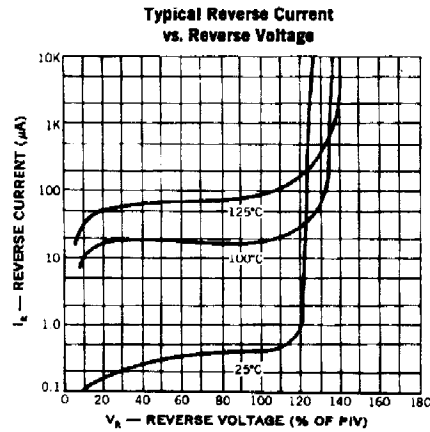
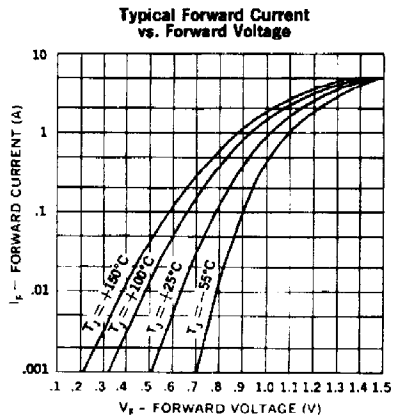
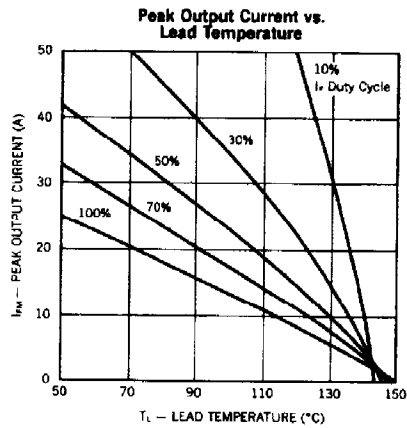
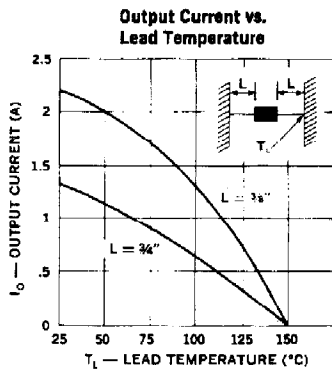

UES804      UES805      UES806  
UES804HR2   UES805HR2   UES806HR2

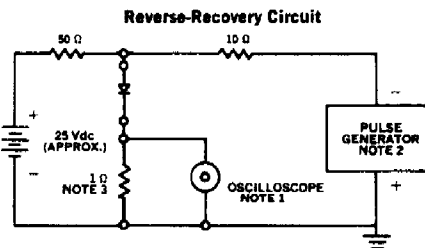
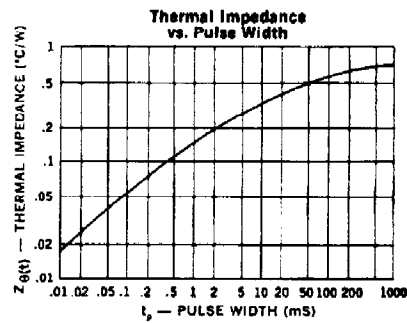
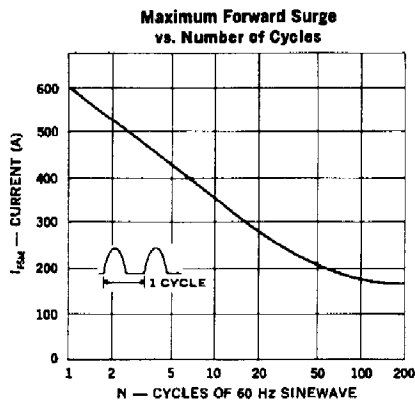

- NOTES:**
1. Oscilloscope: Rise time  $\leq 3$ ns; input impedance = 50 $\Omega$ .
  2. Pulse Generator: Rise time  $\leq 8$ ns; source impedance 100.
  3. Current viewing resistor, non-inductive, coaxial recommended.

**OPTIONAL HIGH RELIABILITY (HR2) SCREENING**

The following tests are performed on 100% of the devices specified UES804HR2, 5HR2, 6HR2.

SCREEN	MIL-STD-750 METHOD	CONDITIONS
1. High Temperature	1032	24 Hours @ $T_A = 150^\circ\text{C}$
2. Temperature Cycle	1051	F, 20 Cycles, $-55$ to $+150^\circ\text{C}$ . No dwell required @ $25^\circ\text{C}$ , $t \geq 10$ min. @ extremes
3. Hermetic Seal a. Fine Leak b. Gross Leak	1071	H, Helium C, Liquid
4. Thermal Impedance		Sage Test
5. Interm Electrical Parameters	GO/NO GO	$V_F$ and $I_R$ @ $25^\circ\text{C}$
6. High Temperature Reverse Blocking	Similar to Method 1040	$\frac{1}{2}$ Sine Reverse, $t = 48$ Hours, $T_C = 125^\circ\text{C}$ , $VRW_M = \text{rating}$ , $F = 50-60$ Hz, $I_O = 0A$
7. Final Electrical Parameters	GO/NO GO	$V_F + I_R$ @ $25^\circ\text{C}$ PDA = 10% (Final Electricals)